

SEMiX352GB128D

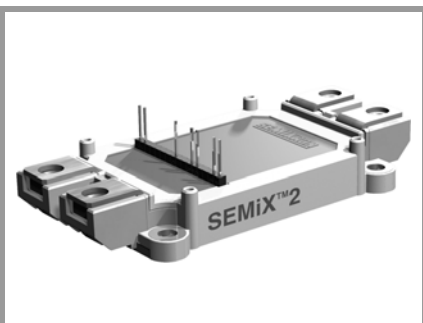

SEMiX[®]2

SPT IGBT Modules

SEMiX352GB128D

Preliminary Data

Features

- Homogeneous Si
- SPT = Soft-Punch-Through technology
- $V_{CE(sat)}$ with positive temperature coefficient
- High short circuit capability

Typical Applications

- AC inverter drives
- UPS
- Electronic welders up to 20 kHz

Remarks

- Not for new design

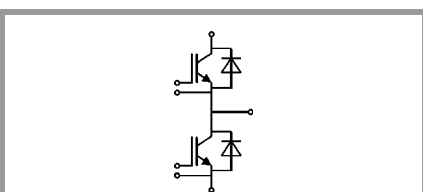

GB

Absolute Maximum Ratings					
Symbol	Conditions		Values	Unit	
IGBT					
V_{CES}			1200	V	
I_C	$T_{vj} = 150^\circ\text{C}$	$T_c = 25^\circ\text{C}$	377	A	
		$T_c = 80^\circ\text{C}$	269	A	
I_{CRM}	$I_{CRM} = 2 \times I_{Cnom}$		400	A	
V_{GES}			-20 ... 20	V	
t_{psc}	$V_{CC} = 600\text{V}$ $V_{GE} \leq 20\text{V}$ $T_{vj} = 125^\circ\text{C}$ $V_{CES} \leq 1200\text{V}$			10	μs
T_{vj}			-40 ... 150	$^\circ\text{C}$	
Inverse diode					
I_F	$T_{vj} = 150^\circ\text{C}$	$T_c = 25^\circ\text{C}$	298	A	
		$T_c = 80^\circ\text{C}$	205	A	
I_{FRM}	$I_{FRM} = 2 \times I_{Fnom}$		400	A	
I_{FSM}	$t_p = 10\text{ms}$, half sine wave, $T_{vj} = 25^\circ\text{C}$		2000	A	
T_{vj}			-40 ... 150	$^\circ\text{C}$	
Module					
$I_{t(RMS)}$			600	A	
T_{stg}			-40 ... 125	$^\circ\text{C}$	
V_{isol}	AC sinus 50Hz, $t = 60\text{s}$		4000	V	

Characteristics						
Symbol	Conditions		min.	typ.	max.	Unit
IGBT						
$V_{CE(sat)}$	$I_{Cnom} = 200\text{A}$ $V_{GE} = 15\text{V}$ chipelevel	$T_{vj} = 25^\circ\text{C}$		1.9	2.35	V
		$T_{vj} = 125^\circ\text{C}$		2.10	2.55	V
V_{CE0}				1	1.15	V
				0.9	1.05	V
r_{CE}	$V_{GE} = 15\text{V}$	$T_{vj} = 25^\circ\text{C}$		4.5	6.0	$\text{m}\Omega$
		$T_{vj} = 125^\circ\text{C}$		6.0	7.5	$\text{m}\Omega$
$V_{GE(th)}$	$V_{GE} = V_{CE}$, $I_C = 8\text{mA}$		4.5	5	6.5	V
I_{CES}	$V_{GE} = 0\text{V}$ $V_{CE} = 1200\text{V}$	$T_{vj} = 25^\circ\text{C}$		0.1	0.3	mA
		$T_{vj} = 125^\circ\text{C}$				mA
C_{ies}	$V_{CE} = 25\text{V}$ $V_{GE} = 0\text{V}$	$f = 1\text{MHz}$		18.9		nF
C_{oes}		$f = 1\text{MHz}$		1.24		nF
C_{res}		$f = 1\text{MHz}$		0.78		nF
Q_G	$V_{GE} = -8\text{V} \dots +15\text{V}$			1920		nC
R_{Gint}	$T_{vj} = 25^\circ\text{C}$			2.00		Ω
$t_{d(on)}$	$V_{CC} = 600\text{V}$			230		ns
t_r	$I_{Cnom} = 200\text{A}$			55		ns
E_{on}	$T_{vj} = 125^\circ\text{C}$			20		mJ
$t_{d(off)}$	$R_{G on} = 3\Omega$			585		ns
	$R_{G off} = 3\Omega$					
t_f				90		ns
E_{off}				21		mJ
$R_{th(j-c)}$	per IGBT				0.083	K/W

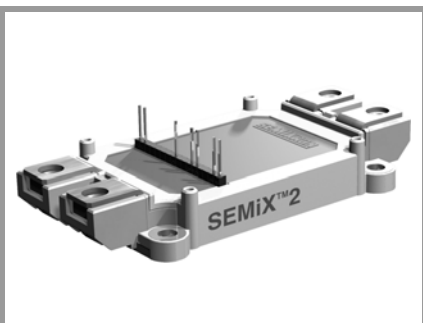

SEMiX[®]2

SPT IGBT Modules

SEMiX352GB128D

Preliminary Data

Features

- Homogeneous Si
- SPT = Soft-Punch-Through technology
- $V_{CE(sat)}$ with positive temperature coefficient
- High short circuit capability

Typical Applications

- AC inverter drives
- UPS
- Electronic welders up to 20 kHz

Remarks

- Not for new design

Characteristics						
Symbol	Conditions		min.	typ.	max.	Unit
Inverse diode						
$V_F = V_{EC}$	$I_{Fnom} = 200A$ $V_{GE} = 0V$ chipllevel	$T_{vj} = 25^\circ C$		2.0	2.5	V
		$T_{vj} = 125^\circ C$		1.8	2.3	V
V_{F0}		$T_{vj} = 25^\circ C$	0.75	1.1	1.45	V
		$T_{vj} = 125^\circ C$	0.5	0.85	1.2	V
r_F		$T_{vj} = 25^\circ C$	3.8	4.5	5.3	m Ω
		$T_{vj} = 125^\circ C$	4.0	4.8	5.5	m Ω
I_{RRM}	$I_{Fnom} = 200A$	$T_{vj} = 125^\circ C$		240		A
Q_{rr}	$di/dt_{off} = 5320A/\mu s$	$T_{vj} = 125^\circ C$		31		μC
E_{rr}	$V_{GE} = -15V$ $V_{CC} = 600V$	$T_{vj} = 125^\circ C$		11		mJ
$R_{th(j-c)D}$	per diode				0.15	K/W
Module						
L_{CE}				18		nH
$R_{CC'+EE'}$	res., terminal-chip	$T_C = 25^\circ C$		0.7		m Ω
		$T_C = 125^\circ C$		1		m Ω
$R_{th(c-s)}$	per module			0.045		K/W
M_s	to heat sink (M5)		3		5	Nm
M_t	to terminals (M6)		2.5		5	Nm
w					0.25	kg
Temperature sensor						
R_{100}	$T_c=100^\circ C$ ($R_{25}=5$ k Ω)			0,493 $\pm 5\%$		k Ω
$B_{100/125}$	$R_{(T)}=R_{100}\exp[B_{100/125}(1/T-1/T_{100})]$; $T[K]$;			3550 $\pm 2\%$		K

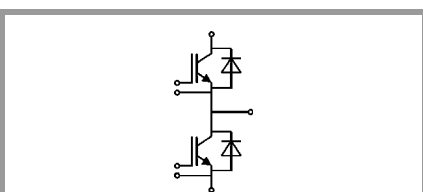

GB

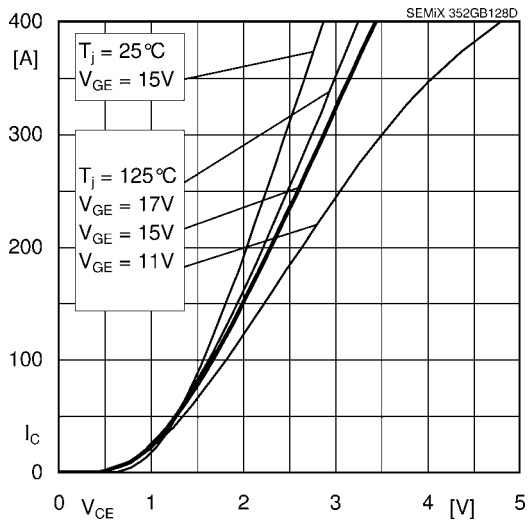

Fig. 1 Typ. output characteristic, inclusive $R_{CC'+EE'}$

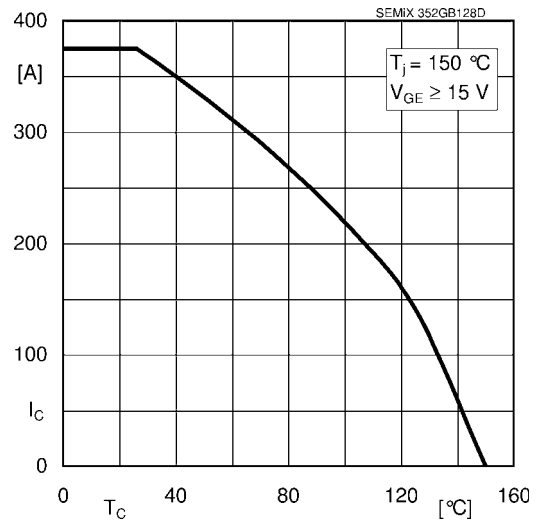

Fig. 2 Rated current vs. temperature $I_C = f(T_C)$

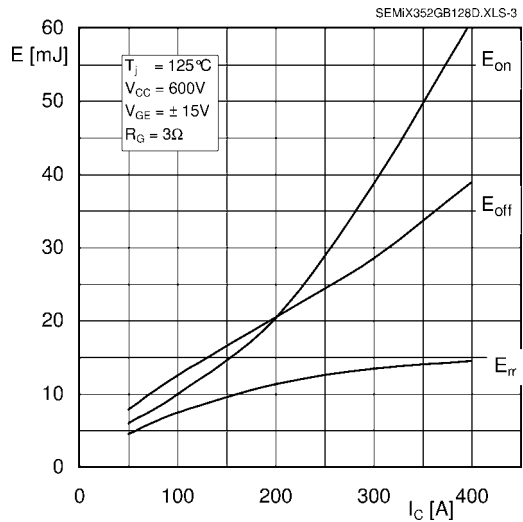

Fig. 3 Typ. turn-on /-off energy = $f(I_C)$

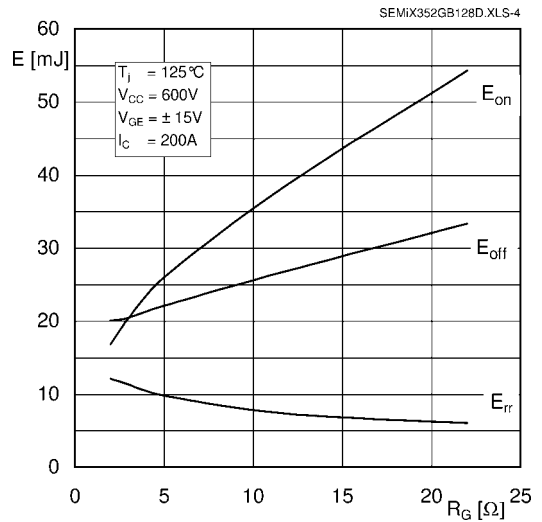

Fig. 4 Typ. turn-on /-off energy = $f(R_G)$

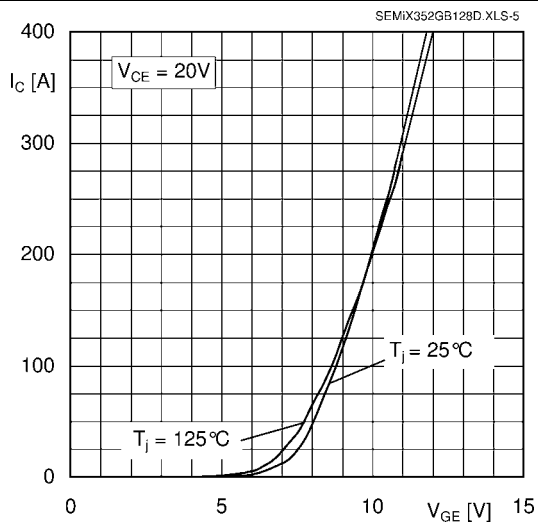

Fig. 5 Typ. transfer characteristic

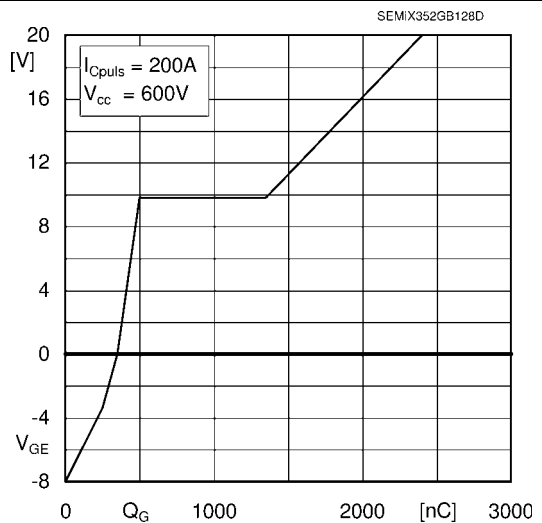
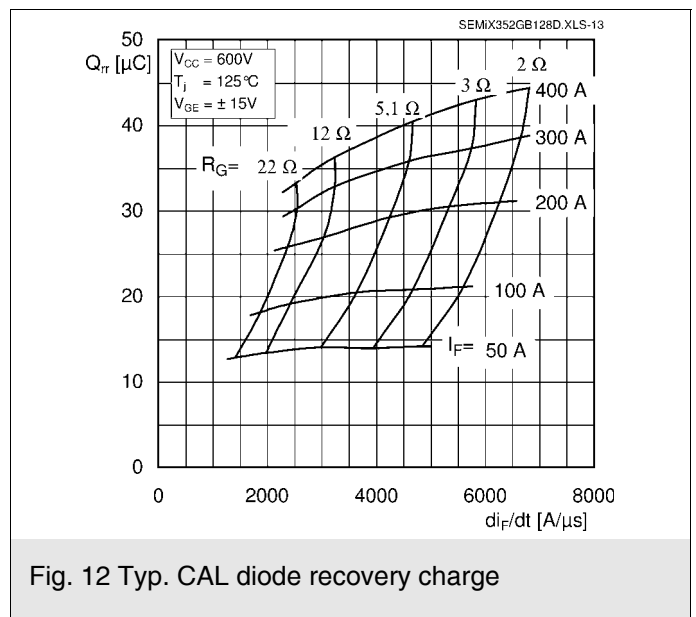
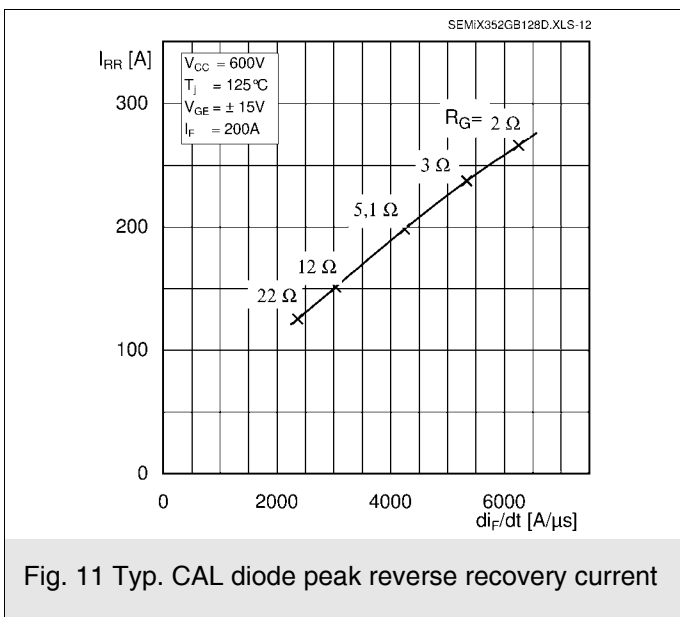
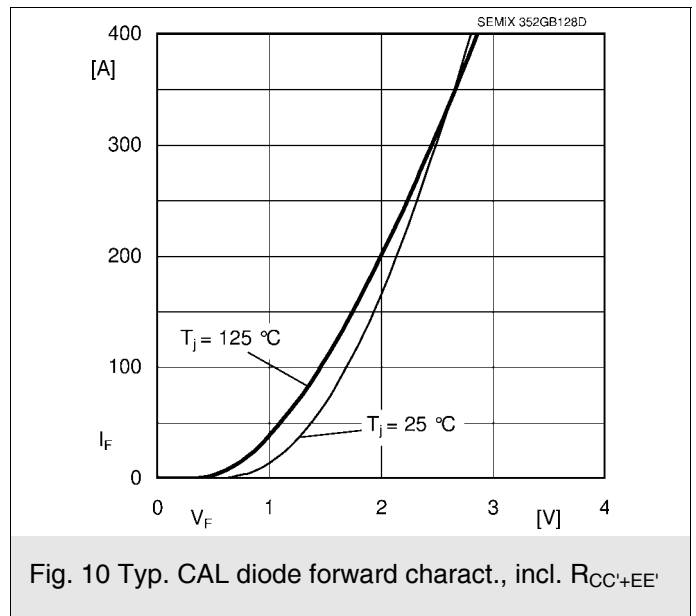
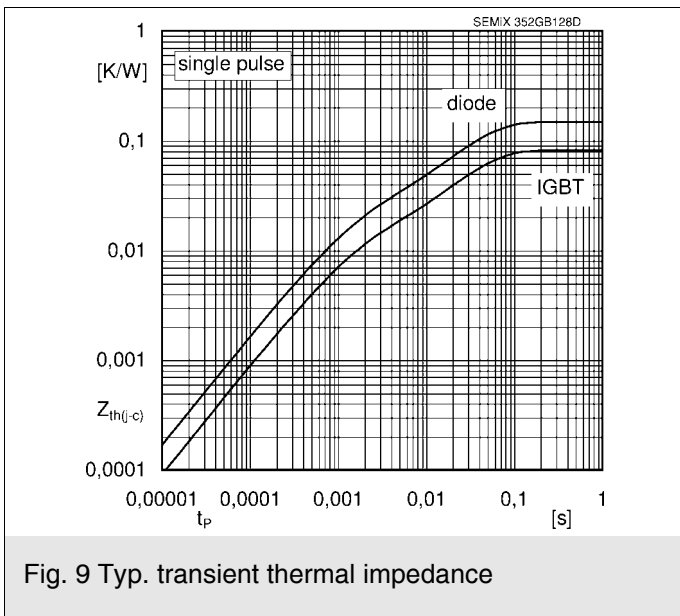
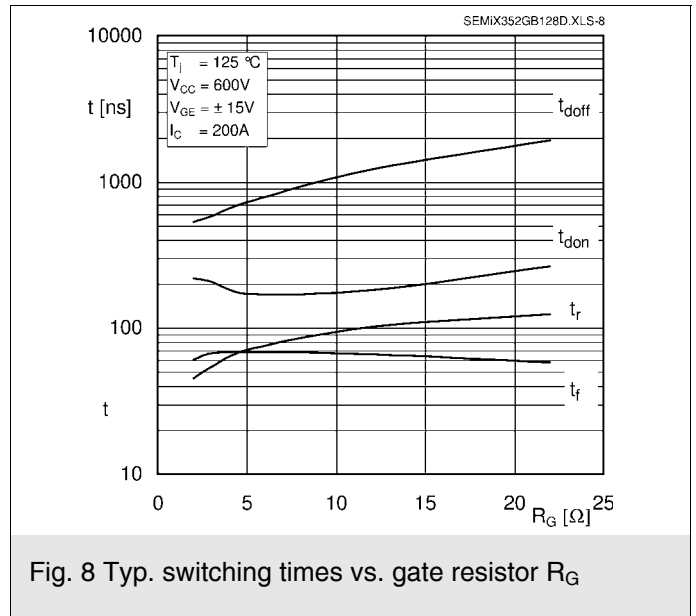
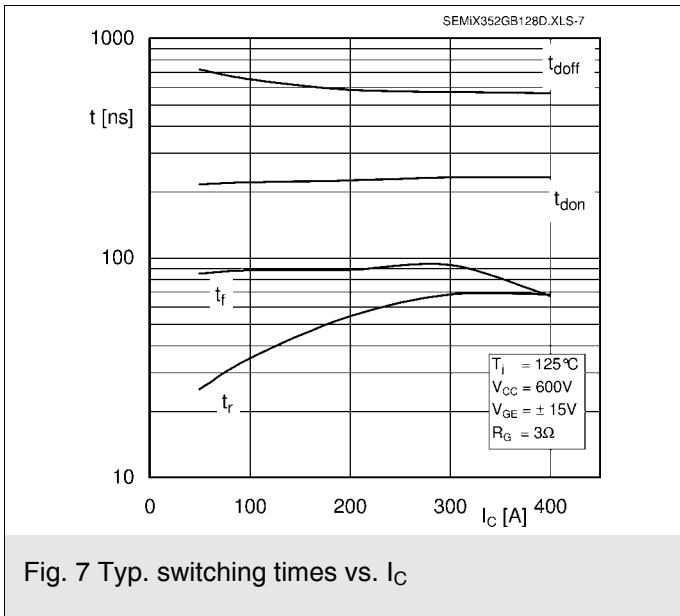
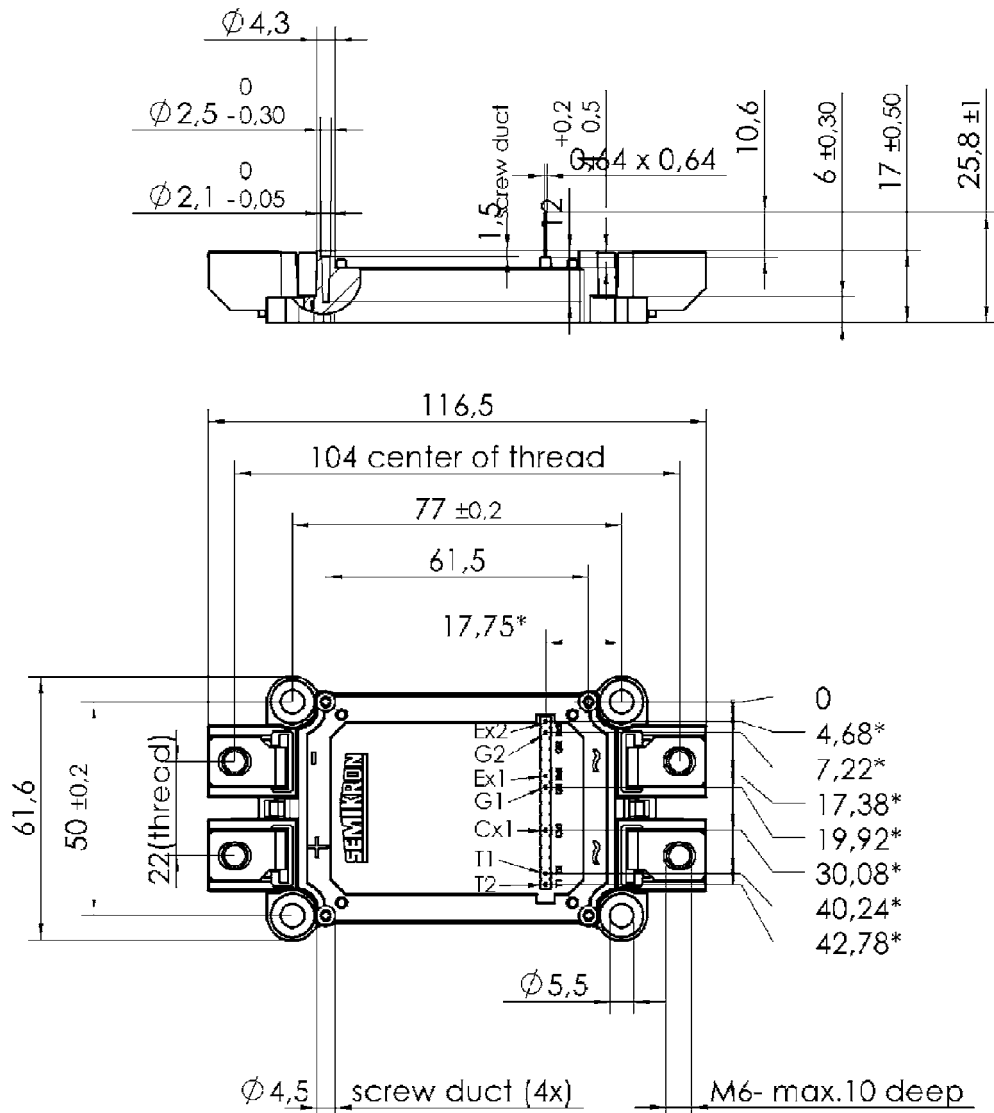

Fig. 6 Typ. gate charge characteristic



SEMiX352GB128D

case: SEMiX 2



* = all measures with $\phi 0,5$

SEMIX 2

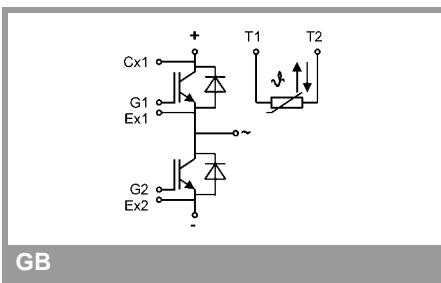

GB

This is an electrostatic discharge sensitive device (ESDS), international standard IEC 60747-1, Chapter IX

This technical information specifies semiconductor devices but promises no characteristics. No warranty or guarantee expressed or implied is made regarding delivery, performance or suitability.