



## Netter Electric External Vibrators



- Circular vibration
- Nominal frequency from 750 min<sup>-1</sup> to 6.000 min<sup>-1</sup>
- Centrifugal force from 40 N to 217.749 N
- Smooth housing surface
- Stainless steel unbalance covers
- Available for ambient temperatures up to 55 °C
- Ex tc IIIC (dust ignition proof) available
- Ex e IIC available
- Degree of protection IP 66-7, insulation class F
- Stainless steel versions available





## Netter Electric External Vibrators

### Contents

	Page		Page
<b>Notes on vibrator design</b>	2	<b>NEG E series</b>	10–11
		NEG as ATEX version	
<b>Designs and ambient conditions</b>	3	<b>NEG S series</b>	12
		Stainless steel, especially smooth surface	
<b>Information on the NEG/NEA/NED series</b>	3	<b>NES series</b>	13
Applications, design and function		Stainless steel, for chemically aggressive ambient conditions	
<b>NEG series</b>	4–7	<b>NEG/NEH series</b>	14
Three-phase alternating current		High frequency electric external vibrators	
<b>NEA series</b>	8–9	<b>Special designs</b>	15
Single-phase alternating current			
<b>NED series</b>	8–9	<b>Accessories</b>	15–16
Direct current			

### Notes on Vibrator Design

#### Formulary

working moment	$M = s \times m$	centrifugal force	$F = a_{(g)} \times m \times 9,81$
acceleration	$a_{(g)} = s \times \left(\frac{n}{1000}\right)^2 \times 5,59$	centrifugal force	$F = M \times \left(\frac{n}{1000}\right)^2 \times 54,84$

#### Symbols and units

s	vibration width	cm	n	frequency	min <sup>-1</sup>
m	weight with vibrator	kg	M	working moment	cmkg
F	centrifugal force	N	a <sub>(g)</sub>	acceleration	g

#### Which kind of vibration for which task?

Task	Frequency	Acceleration [a <sub>(g)</sub> ] Many times the gravitational acceleration	Vibration width	Vibration circular directed
Conveying, dosing	750–3000	2–5	large	↔
Sieving	1000–1500	3–4	large	↔
Draining	1500–3000	3–5	medium	↔
Cleaning, shaking off filter	1500–3000	2–3	medium	↻
Loosening, releasing Emptying bulk materials	1500–3000	0,15–0,2 of the material weight in the conical part of the silo	medium	↻
Compacting bulk materials	1500–6000	2–4	medium	↻ ↔
Compacting cement	3000–9000	0,8–1,5	small	↻ ↔
Testing components	300–6600	0,5–5	adjustable	↻ ↔



All external vibrators manufactured by **NetterVibration** comply with the applicable EU directives and bear the CE mark.



Many external vibrators made by **NetterVibration** meet the standard C22.2 no. LR100-95, file no. LR100948 Part B. Class 421101 Motors and Generators (North America).



## Netter Electric External Vibrators

### Designs and ambient conditions



**Stainless steel vibrators** are resistant to very harsh environmental conditions. Especially the chemical, pharmaceutical and food industries use this resistance in production areas with aggressive, liquid and gaseous media.



**ATEX vibrators** allow operation in explosive atmospheres (ATEX Zones 1, 2, 21 and 22) using special design measures in which gases, vapours, mists and dusts are used. These vibrators, which meet very high safety standards, find a use especially in the chemical and petroleum industry.



**Plastic vibrators** have the advantages of stainless steel devices, but are much lighter. The useful properties of these vibrators are used in the manufacture of dairy products (e.g. cheese), throughout the food industry and in extreme industrial applications.

Series	Stainless	Plastics	ATEX zone 21/22	ATEX zone 22	ATEX zone 1/2
NEG				●	
NEA	●			up to GG 60	
NED		●			
NEGE			●	●	●
NEGS	●				
NES	●		●	●	

### Information on the NEG, NEA and NED series



Conveying



Sieving



Compacting

#### Applications

The electric external vibrators of the series NEG, NEA or NED are always used when, for example, conveyor troughs or sieves have to be driven. In addition, these vibrators can loosen product jams and deposit build-ups in silos. When used on concrete formwork, a high surface quality and compaction of the concrete is achieved by a particularly uniform vibration.

One special feature of the NEG is the maintenance-free operation even under harsh environmental conditions.

#### Design and function

External electric vibrators are unbalance motors based on the short circuit rotor principle and, apart from a few decisive differences, are very similar to commercially available electric motors. The NEG three-phase vibrators run on 230/400 V, 50 Hz, depending on the number of poles, at 750, 1.000, 1.500 or 3.000 min<sup>-1</sup>.

The NEA AC units run on 230 V, 50 Hz at 3.000 min<sup>-1</sup>. Further voltages are available. The NED DC vibrators run on 12 or 24 V at 3.000 min<sup>-1</sup> (NED 601110 only on 24 V, 3.600 min<sup>-1</sup>).

There are unbalances on both shaft ends, which generate an omnidirectional, sinusoidal vibration with the frequency of the corresponding speed.

All NEG/NEA are also designed for use at 60 Hz, the speed is then correspondingly 20 % higher than the values at 50 Hz. The unbalance is adjusted, if necessary. Generously dimensioned roller bearings guarantee a high degree of operational safety. All NEG are fully suitable for operation with Netter frequency converters.



# NetterVibration



## Netter Electric External Vibrators NEG 3-phase AC Series

Unbalance type XL Unbalance type XS Unbalance type XLS

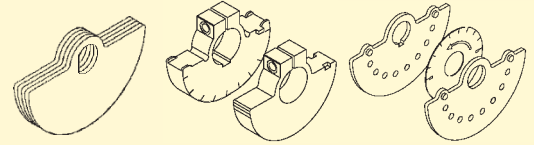

mir <sup>-1</sup>	Type	Housing		ATEXII3D ExtcIIIC	Unbalance [cmkg]		Centrifugal force [N]		Nominal power [kW]		Nominal current [A]		Weight [kg]	
		size	material		T** [°C]	50 Hz	60 Hz	50 Hz	60 Hz	50 Hz 400 V	60 Hz 480 V	50 Hz 400 V	60 Hz 480 V	50 Hz
3000 3600	NEG 5020*	60	AL	100	0,4	0,4	197	284	0,035	0,035	0,15	0,15	2,40	2,40
	NEG 5050*				1	1	494	711	0,045	0,045	0,16	0,16	2,45	2,45
	NEG 5060	100	AL	120	1,2	1,2	592	853	0,12	0,12	0,27	0,23	4,9	4,9
	NEG 50120	101	AL	120	2,4	2,4	1.185	1.706	0,18	0,18	0,35	0,30	5,8	5,8
	NEG 50200				4	3,2	1.974	2.274					6,3	6,3
	NEG 50300	110	AL	120	6	4	2.961	2.843	0,26	0,27	0,60	0,50	9,6	9,3
	NEG 50550	120	AL	120	11,5	6,9	5.676	4.904	0,45	0,50	0,80	0,75	15,2	16,1
	NEG 50770	130	AL	120	14,7	11	7.255	7.818	0,65	0,685	1,10	1,00	19,5	19,9
	NEG 501140	133	AL	120	22,4	14,7	11.056	10.448	1	1,2	1,75	1,75	21,5	24,0
	NEG 501540	140	AL	135	31	21	15.300	14.925	1,4	1,45	2,3	2,0	35,0	32,8
	NEG 501800				36	26	17.768	18.479	2,0	2,0	3,3	2,9	37,0	33,6
	NEG 502020	150	GJS	135	41	26	20.236	18.479	2,2	2,2	3,5	3,0	48	47
	NEG 502270				46	31	22.704	22.033	2,2	2,2	3,5	3,0	49	49
	NEG 503400	170	GJS	135	66	44	32.575	31.272	4,0	4,0	6,2	5,4	106	102
	NEG 503820				77	55	38.004	39.090	4,0	4,0	6,5	5,6	103	103
	NEG 506220	190	GJS	135	126	89	62.189	63.255	5,5	5,5	9,2	8,0	188	181
NEG 508830	195	GJS	-	179	124	88.347	88.130	10,0	9,3	18,0	13,0	215	210	
1500 1800	NEG 2530	101	AL	120	2,4	2,4	296	426	0,085	0,095	0,21	0,20	6,0	6,0
	NEG 2570				6,4	4	790	711					6,9	6,2
	NEG 25210	110	AL	120	16,8	11,8	2.073	2.097	0,17	0,17	0,41	0,40	12,3	11,4
	NEG 25420	120	AL	120	32,6	22,7	4.023	4.033	0,30	0,35	0,60	0,60	19,4	18,4
	NEG 25540				43,8	32,6	5.404	5.792					21,8	20,8
	NEG 25700	130	AL	120	57,2	41,9	7.058	7.445	0,525	0,665	0,92	0,98	26,4	25,4
	NEG 25930	133	AL	120	75	52	9.254	9.239	0,55	0,68	0,95	0,95	28,8	27,3
	NEG 251410	140	AL	120	112	80	13.820	14.215	0,9	1,05	1,45	1,5	43	39
	NEG 251800			143	97	17.645	17.235	1,1	1,2	2,0	1,9	50	45,3	
	NEG 252060			163	112	20.113	19.900	1,35	1,45	2,5	2,3	54	52	
	NEG 252370	160	AL	150	192	135	23.691	23.987	1,6	1,7	3,2	3,0	69	63
	NEG 253050			135	247	172	30.477	30.561	1,9	2,0	3,8	3,5	78,5	79
	NEG 253720	170	GJS	135	302	207	37.264	36.780	2,2	2,5	3,9	3,9	127	122
	NEG 254310				349	235	43.063	41.755	2,5	2,8	4,8	4,65	125	120
	NEG 254900	180	GJS	135	397	273	48.986	48.507	3,6	3,4	6,0	5,0	174	166
	NEG 256460	190	GJS	135	524	365	64.656	64.854	6,0	6,0	10,5	9,0	212	200
	NEG 258040	195	GJS	135	652	452	80.450	80.312	7,0	8,0	11,6	11,5	225	210
	NEG 258260	197	GJS	135	669	492	82.548	87.419	7,5	8,5	12,2	12,0	316	303
NEG 2511210	200	GJS	-	909	633	112.162	112.472	10,0	10,5	17,5	15,5	433	411	
NEG 2513850				1.123	825	138.567	146.587	11,0	12,0	20,0	20,0	458	424	

\* degree of protection IP 65  
PTC thermistors are from housing size 170 up.

\*\* at an ambient temperature of 40 °C max.,  
other temperatures on request

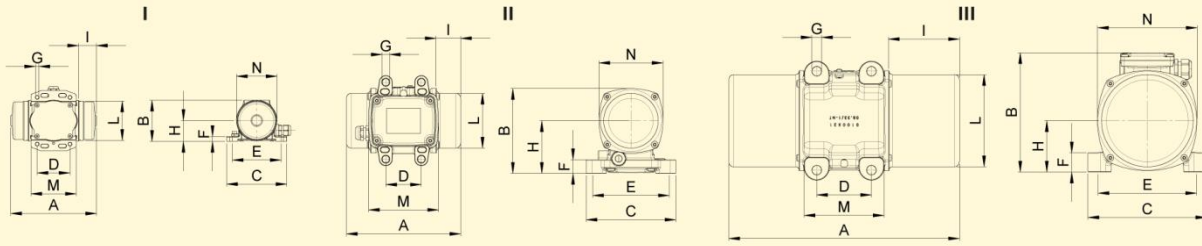

Type	Housing type	Dimensions [mm]													Unbalance [number of unbalance discs]	
		A	B	C	D	E	n <sub>2</sub> *	F	G	H	I	L	M	N	Type	50/60 Hz
NEG 5020	I	157	75	110	<b>60</b>	<b>85</b>	4	9	<b>6,5</b>	38	33	72	83	65	XL	8
NEG 5050		169			25-40	92					39					18
NEG 5060	II	197	123	127	30	85	4	24	9	70	40	103	86	106	XLs	4
					60	<b>85</b>										
					<b>65</b>	106										
					<b>65</b>	<b>140</b>										
NEG 50120	II	209	154,5	164	<b>65</b>	<b>140</b>	4	25	<b>13</b>	96	45	100	128	117	XLs	6
NEG 50200		225			62-74	106			9		53					10/8
NEG 50300	II	255	175,5	164	<b>65</b>	<b>140</b>	4	25	13	105	54	124	128	141	XLs	8/6
NEG 50550	II	284	195	217	<b>100</b>	<b>180</b>	4	30	<b>17</b>	115	63	143	144	160	XLs	10/6
					105	140			13							
NEG 50770	III	308	211	215	100	180	4	35	17	93,5	63	168	144	182	XLs	8/6
NEG 501140	III	314	217	217	100	180	4	35	17	93,5	76	168	146	182	XLs	12/8
NEG 501540	IV	438	257	230	140	190	4	25	17	124,5	103	201	224	241	XLs	12/8
NEG 501800																14/10
NEG 502020	IV	463	235	230	140	190	4	22	17	104	104	188	248	224	XLs	16/10
NEG 502270																18/12
NEG 503400	IV	590	335	310	155	255	4	30	23,5	160	140	274	302	310	XLs	12/8
NEG 503820																14/10
NEG 506220	IV	670	380	390	200	320	4	32	28	189	155	340	360	384	XS	4
NEG 508830	IV	629	395	392	200	320	4	100	28	192	134,5	358	270	375	XS	4
NEG 2530	II	209	154,5	164	<b>65</b>	<b>140</b>	4	25	<b>13</b>	96	45	100	128	117	XLs	6
NEG 2570		241			62-74	106			9		61					16/10
NEG 25210	II	295	175,5	164	<b>65</b>	<b>140</b>	4	25	13	105	74	124	128	141	XS	4
NEG 25420	II	340	195	217	<b>100</b>	<b>180</b>	4	30	<b>17</b>	115	91	143	144	160	XS	4
NEG 25540		105			140	13			111							
NEG 25700	III	378	211	215	100	180	4	35	17	93,5	98	168	144	182	XS	4
NEG 25930	III	422	217	217	100	180	4	35	17	93,5	130	168	146	182	XS	4
NEG 251410	IV	438	257	230	140	190	4	25	17	124,5	103	201	224	241	XS	4
NEG 251800		490									129					
NEG 252060		560									164					
NEG 252370	IV	523	283	275	155	225	4	28	22	140	130	231	255	271	XS	4
NEG 253050		600									168,5					
NEG 253720	IV	588	335	310	155	255	4	30	23,5	160	139	274	302	310	XS	4
NEG 254310		670/588									180/139					
NEG 254900	IV	640	369	340	180	280	4	30	26	173	155	301	322	336	XS	4
NEG 256460	IV	670	380	390	200	320	4	32	28	189	155	340	360	384	XS	4
NEG 258040	IV	624	402	392	200	320	4	35	28	199,5	132	358	352	402	XS	4
NEG 258260	VI	862	434,5	460	125	380	6	35	38	215	230	379	392	439	XS	4
NEG 2511210	VI	990	454	530	140	440	6	38	44	230	240	423	510	448	XS	4
NEG 2513850																

\* number of bores

\*\* recommended mounting dimensions printed in bold



# NetterVibration



## Netter Electric External Vibrators NEG 3-Phase AC Series

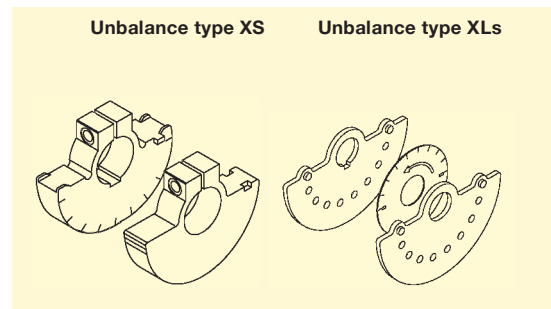

min <sup>-1</sup>	Type	Housing size	Housing material	ATEXII3D	Unbalance [cmkg]		Centrifugal force [N]		Nominal power [kW]		Nominal current [A]		Weight [kg]					
				ExtcIIIC	50 Hz	60 Hz	50 Hz	60 Hz	50 Hz 400 V	60 Hz 480 V	50 Hz 400 V	60 Hz 480 V	50 Hz	60 Hz				
				T* [°C]														
1000 1200	NEG 1630	110	AL	120	6	6	329	474	0,12	0,135	0,30	0,30	9,4	10,01				
	NEG 1690				16,8	16,8	921	1.327					12,2	12,7				
	NEG 16190	120	AL	120	32,6	32,6	1.788	2.577	0,185	0,205	0,50	0,50	18,9	20,5				
	NEG 16310	130	AL	120	57,2	41,9	3.137	3.309	0,35	0,38	0,72	0,68	26,1	27,9				
	NEG 16410	133	AL	120	75	52	4.113	4.106	0,35	0,38	0,75	0,67	28,7	33,6				
	NEG 16810	140	AL	135	144	112	7.897	8.845	0,68	0,76	1,4	1,4	45	41				
	NEG 161130				202	143	11.078	11.293	0,75	0,75	1,7	1,5	57	48				
	NEG 161420				254	187	13.929	14.767	0,95	1,0	1,8	1,7	64	58				
	NEG 161610	160	AL	135	293	192	16.068	15.162	1,1	1,3	2,2	2,2	80	76				
	NEG 162110				385	264	21.113	20.848	1,5	1,77	3,0	2,8	95	83				
	NEG 162550	170	GJS	135	464	323	25.446	25.507	1,96	2,1	4,1	3,75	140	127				
	NEG 163030				553	400	30.327	31.588	2,2	2,4	4,5	4,3	156	141				
	NEG 163820	180	GJS	135	696	467	38.169	36.879	2,5	3,0	5,1	5,0	200	182				
	NEG 164700				857	587	46.998	46.355	3,2	3,6	6,5	6,0	219	198				
	NEG 165190	190	GJS	135	946	658	51.879	51.962	3,8	4,0	7,0	6,5	232	225				
	NEG 165580			-	1.009	706	55.334	55.753	3,8	3,9	7,0	7,1	240	245				
	NEG 166270			135	1.143	795	62.682	62.781	4,3	5,0	8,2	8,1	279	251				
	NEG 166670	197	GJS	-	1.217	796	66.740	62.860	5,0	5,9	10,0	9,8	285	257				
	NEG 167890	195	GJS	135	1.439	993	78.915	78.417	7,0	7,5	12,6	11,3	320	282				
	NEG 168500				1.550	1.077	85.002	85.050	7,5	8,2	14,0	12,9	326	289				
NEG 169510	197	GJS	135	1.735	1.133	95.147	89.473	7,6	8,0	13,5	12,4	381	340					
NEG 1612060	200			2.199	1.509	120.593	119.165	9,0	9,5	16,3	15,0	500	445					
NEG 1613890	205	GJS	-	2.532	1.740	138.855	137.407	10,6	11,3	19,0	18,0	643	605					
NEG 1617000				3.100	2.088	170.004	164.889	13,0	13,7	24,5	23,0	705	656					
750 900	NEG 12100	120	AL	130	32,6	32,6	1.006	1.448	0,23	0,25	0,85	0,76	20,5	20,5				
	NEG 12180	130	AL	130	56,8	56,8	1.752	2.523	0,35	0,38	1,10	1,05	28,0	28,0				
	NEG 12230	133	AL	120	75	75	2.314	3.332	0,6	0,68	0,28	0,3	34,6	34,6				
	NEG 12460	140	AL	120	144	142	4.442	6.308	0,4	0,45	1,2	1,2	46	46				
	NEG 12640				202	196	6.231	8.706		0,5	1,4	1,3	57	57				
	NEG 12900	160	AL	150	293	293	9.038	13.015	0,95	1,1	2,2	2,2	80	80				
	NEG 121430	170	GJS	135	464	464	14.313	20.611	1,5	1,79	4,1	4,2	133	133				
	NEG 122150	180	GJS	135	696	696	21.470	30.917	2,0	2,3	5,4	5,2	201	201				
	NEG 122640				857	857	26.436	38.068	2,5	3,0	6,0	6,0	217	217				
	NEG 122920	190	GJS	135	964	964	29.737	42.821	2,8	3,35	6,5	6,5	242	242				
	NEG 123530				1.143	1.143	35.259	50.773	4,0	4,3	8,2	7,85	267	267				
	NEG 124440	195	GJS	135	1.439	1.439	44.390	63.921	4,9	5,8	9,9	9,5	320	320				
	NEG 127640	197			2.478	2.195	76.440	97.503	6,8	7,5	13,2	12,0	438	419				
	NEG 128520	200	GJS	-	2.763	2.481	85.232	110.207	7,6	8,3	14,0	13,5	540	520				
	NEG 1211070	205	GJS	-	3.589	3.100	110.712	137.703	9,2	9,6	21,0	19,5	702	680				
	NEG 1213160				4.267	3.813	131.626	169.375	10,4	11,2	22,0	20,0	755	711				
	NEG 1217670	210	GJS	-	5.727	4.902	176.664	217.749	12,5	16,2	26,5	28,0	1.015	981				

PTC thermistors are standard from housing size 170 up.

\*at an ambient temperature of 40 °C max., other temperatures on request

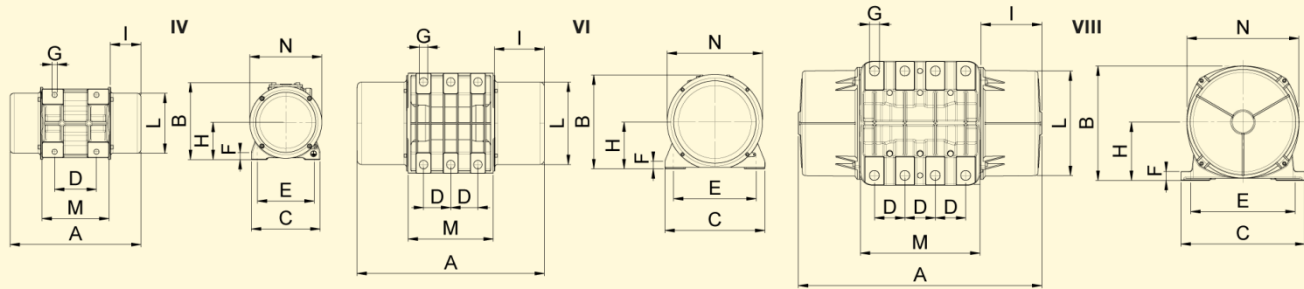

Type	Housing type	Dimensions [mm]														Unbalance [number of unbalance discs]		
		A	B	C	D	E	n <sub>2</sub> *	F	G	H	I	L	M	N	Type	No.		
		50/60 Hz																
		mounting dimensions**																
NEG 1630	II	255	175,5	164	<b>65</b>	<b>140</b>	4	25	13	105	54	124	128	141	XLs	8		
NEG 1690		295			90	125					74				XS	4		
NEG 16190	II	340	195	217	<b>100</b>	<b>180</b>	4	30	17	115	91	143	164	160	XS	4		
NEG 16310					105	140									13	93,5	98	168
NEG 16410	III	422	217	217	100	180	4	35	17	93,5	130	168	146	182	XS	4		
NEG 16810	IV	490/438	257	230	140	190	4	25	17	124,5	129/103	201	224	241	XS	4		
NEG 161130		506									164							
NEG 161420		608									188							
NEG 161610	IV	600/523	283	275	155	225	4	28	22	140	168,5/130	231	255	271	XS	4		
NEG 162110		655/600									196/168,5							
NEG 162550	IV	670/610	335	310	155	255	4	30	23,5	160	180/150	274	302	310	XS	4		
NEG 163030		710									200							
NEG 163820	IV	742	369	340	180	280	4	30	26	173	206	301	322	336	XS	4		
NEG 164700		802									236							
NEG 165190	IV	772	380	390	200	320	4	32	28	189	206	340	360	384	XS	4		
NEG 165580		836									238						334	352
NEG 166270		850									245						340	360
NEG 166670	VI	750	434,5	460	125	380	6	35	39	215	174	379	392	439	XS	4		
NEG 167890	IV	854	402	392	200	320	4	35	28	199,5	247	358	352	402	XS	4		
NEG 168500																		
NEG 169510	VI	862	434,5	460	125	380	6	35	39	215	230	379	392	439	XS	4		
NEG 1612060	VI	990	454	530	140	440	6	38	44	230	240	423	510	448	XS	4		
NEG 1613890	VIII	960	526	570	140	480	8	41	45	268	200	488	560	516	XS	4		
NEG 1617000		1.040									240							
NEG 12100	II	340	195	217	<b>100</b>	<b>180</b>	4	30	<b>17</b>	115	91	143	144	160	XS	4		
NEG 12180	III	378	211	215	100	180	4	35	17								93,5	98
NEG 12230	III	422	217	217	100	180	4	35	17	93,5	130	168	146	182	XS	4		
NEG 12460	IV	490	257	230	140	190	4	25	17	124,5	129	201	224	241	XS	4		
NEG 12640		560									164							
NEG 12900	IV	600	283	275	155	225	4	28	22	140	168,5	231	255	271	XS	4		
NEG 121430	IV	670	335	310	155	255	4	30	23,5	160	180	274	302	310	XS	4		
NEG 122150	IV	742	369	340	180	280	4	30	26	173	206	301	322	336	XS	4		
NEG 122640		802									236							
NEG 122920	IV	772	380	390	200	320	4	32	28	189	206	340	360	384	XS	4		
NEG 123530		850									245							
NEG 124440	IV	854	402	392	200	320	4	35	28	199,5	247	358	352	402	XS	4		
NEG 127640	VI	1.002	434,5	460	125	380	6	35	39	215	300	379	392	439	XS	4		
NEG 128520	VI	1.070	454	530	140	440	6	38	44	230	280	423	510	448	XS	4		
NEG 1211070	VIII	1.140	526	570	140	480	8	41	45	268	240	488	560	516	XS	4		
NEG 1213160		1.120									280							
NEG 1217670	VIII	1.150	607	610	140	520	8	38	45	297	280	542	510	582	XS	4		

\* number of bores

\*\* recommended mounting dimensions printed in bold



**NetterVibration**



**Netter Electric External Vibrators**  
NEA Single-Phase AC Series

Unbalance type XL Unbalance type XS Unbalance type XLs

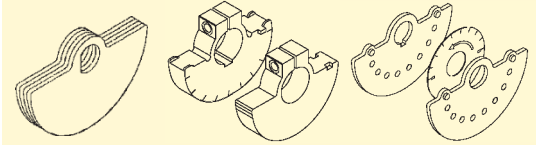

min <sup>-1</sup>	Type	Housing size	Housing material	Unbalance [cmkg]		Centrifugal force [N]		Nominal power [kW]		Nominal current [A]		Weight [kg]	
				50 Hz	60 Hz	50 Hz	60 Hz	50 Hz 230 V	60 Hz 115V	50 Hz 230 V	60 Hz 115V	50 Hz	60 Hz
3000 3600	NEA 504*	50	AL	0,1	0,1	49	71	0,024	0,024	0,13	0,30	1,0	1,0
	NEA 5020	60	AL	0,4	0,4	197	284	0,035	0,035	0,17	0,42	2,20	2,20
	NEA 5050			1	1	494	711	0,045	0,045	0,20	0,46	2,45	2,45
	NEA 5060	100	AL	1,2	1,2	592	853	0,11	0,11	0,56	1,52	4,9	4,9
	NEA 50120	101	AL	2,4	2,4	1.185	1.706	0,165	0,165	0,75	1,52	5,9	5,9
	NEA 50200			4	3,2	1.974	2.274					6,5	6,3
	NEA 50300	110	AL	6	4	2.961	2.843	0,28	0,28	1,25	2,40	10,2	10,0
	NEA 50550	120	AL	11,5	6,9	5.676	4.904	0,5	0,5	2,30	4,50	16,3	16,1
NEA 50770	130	AL	14,7	11	7.255	7.818	0,7	0,75	3,25	7,00	22,1	21,6	
1500 1800	NEA 2530	101	AL	2,4	2,4	296	426	0,09	-	0,43	-	6,1	5,8
	NEA 2570			6,4	4,8	790	853					7,3	6,9
	NEA 25210	110	AL	16,8	11,8	2.073	2.097	0,21	-	1,00	-	12,8	11,8
	NEA 25420	120	AL	32,6	22,7	4.023	4.033	0,24	-	1,20	-	20,7	19,7
	NEA 25540			43,8	32,6	5.404	5.792					22,7	21,7
	NEA 25700	130	AL	57,2	41,9	7.058	7.445	0,45	-	2,50	-	29,4	28,4

\* degree of protection IP 65



**Netter Electric External Vibrators**  
NED Direct Current Series

NED 605

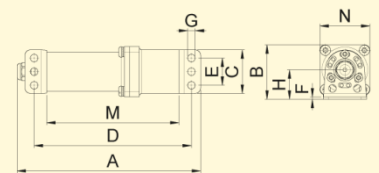

Type	Revolutions [min <sup>-1</sup> ]	Nominal voltage [V]	Housing size	Housing material	Unbalance [cmkg]	Centrifugal force [N]	Nominal power [kW]	Nominal current [A]		Weight [kg]
								24V	12V	
NED 605	3.600	24/-	-	AL/POM	0,07	50	0,011	0,45	-	0,4
NED 5016	3.600	24/12	-	POM	0,3	213	0,02	0,6	1,4	1,5
NED 50100	3.000	24/12	102	AL	2,4	1.185	0,19	4,0	8,0	5,7
NED 50200	3.000	24/12	103	AL	4	1.974	0,19	8,0	16,0	6,0
NED 50500	3.000	24/12	122	AL	10	4.936	0,27	11,3	22,5	13,1
NED 601110	3.600	24/-	133	AL	15,6	11.087	0,53	22,0	-	20,8
NED 601510	3.600	24/-	133	AL	21	14.925	0,53	22,0	-	21,5



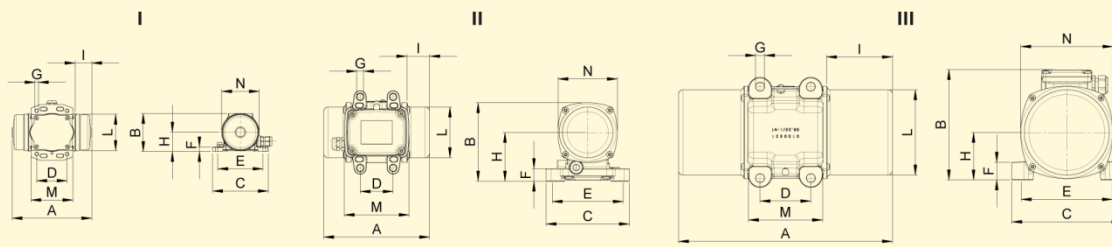

Type	Housing type	Dimensions [mm]													Unbalance [number of unbalance discs]	
		A	B	C	D E n <sub>2</sub> * F G mounting dimensions**				H	I	L	M	N	Type	50/60 Hz	
NEA 504	I	111	67	90	25-40	75	4	9	5,5	34	24	63	59	65	XL	8
NEA 5020	I	157	75	110	<b>60</b>	<b>85</b>	4	9	<b>6,5</b>	38	33	72	83	74	XL	8
NEA 5050		169			25-40	92										39
NEA 5060	II	197	123	127	30	85	4	24	<b>9</b>	70	40	103	86	106	XLs	4
					30	102										
					<b>60</b>	<b>85</b>										
					60	106										
NEA 50120	II	209	154,5	164	<b>65</b>	<b>140</b>	4	25	<b>13</b>	96	45	100	128	117	XLs	6
NEA 50200		225			62-74	106					9					53
NEA 50300	II	255	175,5	164	<b>65</b>	<b>140</b>	4	25	<b>13</b>	105	54	124	128	141	XLs	8/6
NEA 50550	II	284	195	217	<b>100</b>	<b>180</b>	4	30	<b>17</b>	115	63	143	144	160	XLs	10/6
					105	140										
NEA 50770	III	308	211	215	100	180	4	35	17	93,5	63	168	144	182	XLs	8/6
NEA 2530	II	209	154,5	164	<b>65</b>	<b>140</b>	4	25	<b>13</b>	96	45	100	128	117	XLs	6
NEA 2570		241			62-74	106					9					61
NEA 25210	II	295	175,5	164	<b>65</b>	<b>140</b>	4	25	<b>13</b>	105	74	124	128	141	XS	4
					90	125										
NEA 25420	II	340	195	217	<b>100</b>	<b>180</b>	4	30	<b>17</b>	115	91	143	144	160	XS	4
NEA 25540		380			105	140					13					
NEA 25700	III	378	211	215	100	180	4	35	17	93,5	98	167	144	193	XS	4

NED 5016

NED 50100/NED 50200

NED 601110/NED 601510

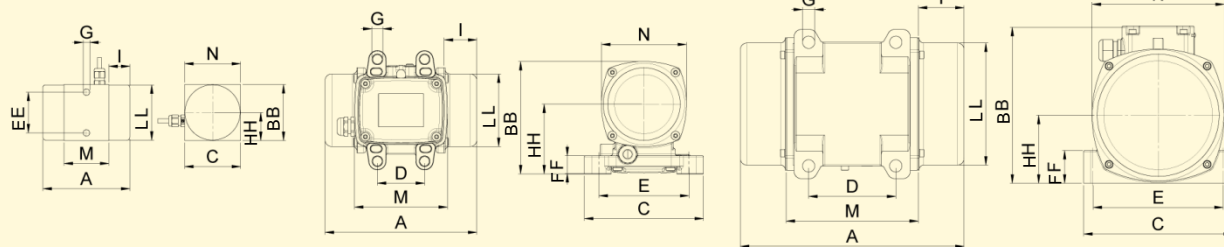

Type	Dimensions [mm]													Unbalance [number of unbalance discs]	
	A	B	C	D E F G mounting dimensions**				H	I	L	M	N	Type	No.	
NED 605	169	50	40	145	25	2	7	27	-	-	122	46	XL	1	
NED 5016	121	77	77	-	56	-	9	38,5	29	76	63	-	XL	6	
NED 50100	209	154,5	164	<b>65</b>	<b>140</b>	25	13	96	45	100	128	117	XLs	6	
				62-74	106										9
NED 50200	225	154,5	164	<b>65</b>	<b>140</b>	25	13	96	53	100	128	117	XLs	10	
				62-74	106										9
NED 50500	288	203	167	105	140	30	13	82,5	65	145	140	160	XM	4	
NED 601110	308	216	205	120	170	45	17	93,5	63	170	160	182	XM	4	
NED 601510	308	216	205	120	170	45	17	93,5	63	170	160	182	XM	4	

\* number of bores

\*\* recommended mounting dimensions printed in bold



# NetterVibration



## Netter Electric External Vibrators

NEG E Series

Ex e IIC Gb

Ex tb IIIC Db



Unbalance type XLs

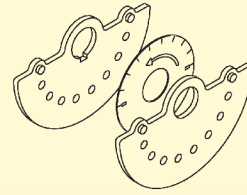

Unbalance type XS

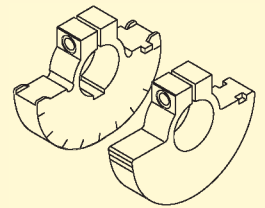

min <sup>-1</sup>	Type	Housing size	Max. surface temperature* (dust) [°C]	Temperature class (gas)	Power consumption <sup>1)</sup> [kW]		Nominal current <sup>2)</sup> [A]		t <sub>E</sub> [s]		I <sub>A</sub> / I <sub>N</sub>	
					T3	T4	T3	T4	T3	T4	T3	T4
3000 3600	NEG 50300 E	110	120	T3, T4	0,26	0,23	0,57	0,48	18	12	3,50	4,20
	NEG 50550 E	120	120	T3, T4	0,50	0,35	0,76	0,57	12	8	4,20	5,60
	NEG 50770 E	130	120	T3, T4	0,55	0,39	0,95	0,72	12	8	4,20	5,52
	NEG 501140 E	133	120	T3, T4	0,55	0,46	0,86	0,76	15	11	3,88	4,37
	NEG 501540 E	140	135, 115	T3, T4	1,01	0,83	1,62	1,43	6	6	9,29	7,30
	NEG 501800 E	140	135	T3	1,01	-	1,62	-	6	-	9,29	-
	NEG 502020 E	150	170	T3	1,11	-	1,90	-	7	-	5,90	-
NEG 502270 E	150	170	T3	1,11	-	1,90	-	7	-	5,90	-	
1500 1800	NEG 25210 E	110	120	T3, T4	0,20	0,17	0,45	0,39	35	28	2,04	2,34
	NEG 25420 E	120	120	T3, T4	0,30	0,28	0,57	0,52	18	16	3,33	3,63
	NEG 25540 E	120	120	T3, T4	0,30	0,28	0,57	0,52	18	16	3,33	3,63
	NEG 25700 E	130	120	T3, T4	0,46	0,36	0,86	0,72	17	12	3,50	4,20
	NEG 25930 E	133	120	T4	-	0,37	-	0,81	-	13	-	4,00
	NEG 251410 E	140	120	T3, T4	0,90	0,63	1,38	1,05	13	8	4,00	5,36
	NEG 251800 E	140	150, 120	T3, T4	1,10	0,63	1,90	1,33	9	5,5	4,95	7,00
	NEG 252370 E	160	150, 135	T3, T4	1,60	1,15	3,04	2,47	7	5,5	6,00	7,50
	NEG 253720 E	170	135	T3, T4	2,20	1,85	3,71	3,14	6	6	7,17	8,42
	NEG 254900 E	180	135	T3	3,20	-	5,70	-	6	-	7,00	-
1000 1200	NEG 16190 E	120	120	T4	-	0,18	-	0,48	-	25	-	2,72
	NEG 16310 E	130	120	T4	-	0,32	-	0,67	-	25	-	2,81
	NEG 16410 E	133	120	T4	-	0,35	-	0,71	-	26	-	2,40
	NEG 16810 E	140	135	T3, T4	0,68	0,50	1,33	1,05	25	17	2,78	3,54
	NEG 161130 E	140	135	T3, T4	0,75	0,48	1,57	1,24	19	13	3,33	4,23
	NEG 161610 E	160	135	T3, T4	1,10	0,85	2,09	1,81	15	10	3,63	4,73
	NEG 162550 E	170	135	T3	1,96	-	3,90	-	8	-	5,31	-
	NEG 163820 E	180	135	T3, T4	2,20	2,00	4,85	4,28	7	6	5,88	6,66
	NEG 165190 E	190	135	T3	3,50	-	6,65	-	10	-	4,64	-
750 900	NEG 12100 E	120	130	T3	0,23	-	0,67	-	25	-	2,00	-
	NEG 12180 E	130	130	T3	0,35	-	0,86	-	25	-	2,47	-
	NEG 12230 E	133	120	T4	-	0,28	-	0,57	-	30	-	1,66
	NEG 12460 E	140	120	T3	0,50	-	1,14	-	30	-	2,15	-
	NEG 12640 E	140	120	T3, T4	0,60	0,45	1,33	1,14	30	25	2,14	2,50
	NEG 12900 E	160	150	T3	0,95	-	2,09	-	30	-	2,63	-
	NEG 121430 E	170	135	T3	1,50	-	3,61	-	15	-	4,18	-
	NEG 122150 E	180	135	T3	2,00	-	5,13	-	13	-	3,96	-
	NEG 122920 E	190	135	T3	2,63	-	6,18	-	14	-	3,84	-
	NEG 123530 E	190	135	T3	3,52	-	7,79	-	14	-	3,80	-

<sup>1)</sup> at 50 Hz, <sup>2)</sup> at 400 V, 50 Hz, <sup>1)2)</sup> vibrators at 60 Hz on request  
T3 = 200 °C, T4 = 135 °C

\* at an ambient temperature of 40 °C max.  
PTC thermistors are standard from housing size 170 up

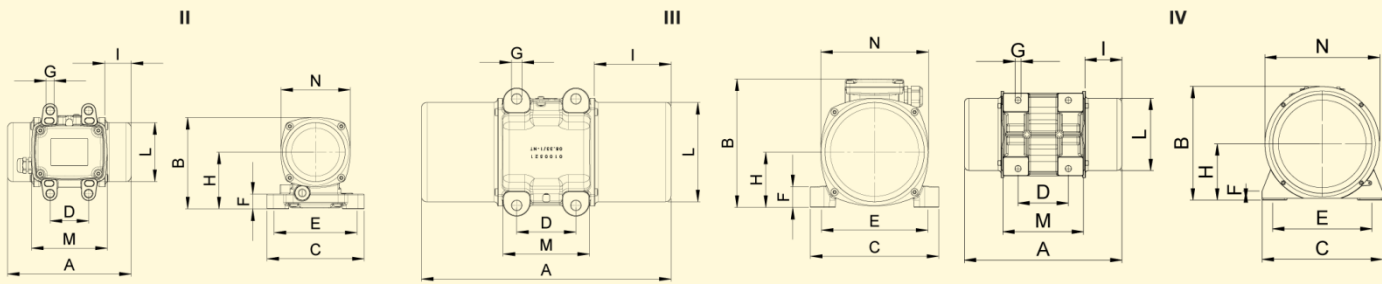

Type	Housing type	Dimensions [mm]													Unbalance [number of unbalance discs]	
		A	B	C	D	E	n <sub>2</sub> *	F	G	H	I	L	M	N	Type	50/60 Hz
NEG 50300 E	II	255	175,5	164	65	140	4	25	13	105	54	124	128	141	XLs	8/16
					90	125										
NEG 50550 E	II	284	195	217	100	180	4	30	17	115	63	143	144	160	XLs	10/6
					105	140										
NEG 50770 E	III	308	211	215	100	180	4	35	17	93,5	63	168	144	182	XLs	8/6
NEG 501140 E	III	314	217	217	100	180	4	35	17	93,5	76	168	146	182	XLs	12/8
NEG 501540 E	IV	438	257	230	140	190	4	25	17	124,5	103	201	224	241	XLs	12/8
NEG 501800 E																14/10
NEG 502020 E	IV	463	235	230	140	190	4	22	17	104	104	188	248	224	XLs	16/10
NEG 502270 E																18/12
NEG 25210 E	II	295	175,5	164	65	140	4	25	13	105	74	124	128	141	XS	4
					90	125										
NEG 25420 E	II	340	195	217	100	180	4	30	17	115	91	143	144	160	XS	4
NEG 25540 E		380			105	140										
NEG 25700 E	III	378	211	215	100	180	4	35	17	93,5	98	168	144	182	XS	4
NEG 25930 E	III	422	217	217	100	180	4	35	17	93,5	130	168	146	182	XS	4
NEG 251410 E	IV	438	257	230	140	190	4	25	17	124,5	103	201	224	241	XS	4
NEG 251800 E		490														
NEG 252370 E	IV	523	283	275	155	225	4	28	22	140	130	231	255	271	XS	4
NEG 253720 E	IV	588	335	310	155	255	4	30	23,5	160	139	274	302	310	XS	4
NEG 254900 E	IV	640	369	340	180	280	4	30	26	173	155	301	322	336	XS	4
NEG 16190 E	II	340	195	217	100	180	4	30	17	115	91	143	144	160	XS	4
					105	140										
NEG 16310 E	III	378	211	215	100	180	4	35	17	93,5	98	168	144	182	XS	4
NEG 16410 E	III	422	217	217	100	180	4	35	17	93,5	130	168	146	182	XS	4
NEG 16810 E	IV	490	257	230	140	190	4	25	17	124,5	129	201	224	241	XS	4
NEG 161130 E		560														
NEG 161610 E	IV	600	283	275	155	225	4	28	22	140	168,5	231	255	271	XS	4
NEG 162550 E	IV	670	335	310	155	255	4	30	23,5	160	180	274	302	310	XS	4
NEG 163820 E	IV	742	369	340	180	280	4	30	26	173	206	301	322	336	XS	4
NEG 165190 E	IV	772	380	390	200	320	4	32	28	189	206	340	360	384	XS	4
NEG 12100 E	II	340	195	217	100	180	4	30	17	115	91	143	144	160	XS	4
					105	140										
NEG 12180 E	III	378	211	215	100	180	4	35	17	93,5	98	168	184	182	XS	4
NEG 12230 E	III	422	217	217	100	180	4	35	17	93,5	130	168	145	182	XS	4
NEG 12460 E	IV	490	257	230	140	190	4	25	17	124,5	129	201	224	241	XS	4
NEG 12640 E		560														
NEG 12900 E	IV	600	283	275	155	225	4	28	22	140	168,5	231	255	271	XS	4
NEG 121430 E	IV	670	335	310	155	255	4	30	23,5	160	180	274	302	310	XS	4
NEG 122150 E	IV	742	369	340	180	280	4	30	26	173	206	301	322	336	XS	4
NEG 122920 E	IV	772	380	390	200	320	4	32	28	189	206	340	360	384	XS	4
NEG 123530 E		850														

\* number of bores

\*\* recommended mounting dimensions printed in bold



## Netter Stainless Steel Electric External Vibrators NEG S Series



NEG 5020 S and NEG 5050 S

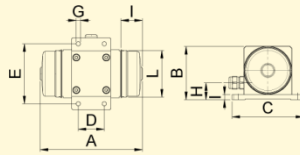

other types of NEG S

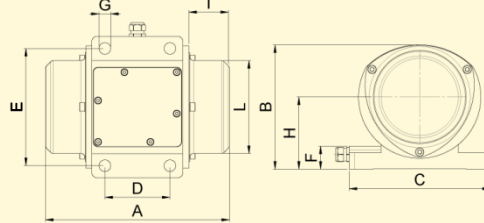

min <sup>-1</sup>	Type	Housing size	Unbalance [cmkg]		Centrifugal force [N]		Nominal power [kW]		Nominal current [A]		Weight [kg]		Dimensions [mm]							
			50 Hz	60 Hz	50 Hz	60 Hz	50 Hz	60 Hz	50 Hz	60 Hz	50 Hz	60 Hz	A	B	C	D	E	F	G	I
			400 V	480 V	400 V	480 V	400 V	480 V	400 V	480 V	400 V	480 V	50Hz	60Hz						
3000 3600	NEG 5020 S	60	0,39	0,39	192	277	0,035	0,035	0,15	0,15	3,8	3,8	157	82	110	40	92	8	6,5	33
	NEG 5050 S		0,91	0,91	450	647	0,045	0,045	0,16	0,16	4,0	4,0	169							
	NEG 50120 S	101	2,4	2,4	1.185	1.708	0,18	0,18	0,35	0,30	11,2	11,1	207	139	164	65	140	18	13	44
	NEG 50200 S		4,2	3,0	2.073	2.133					11,8	11,6	223							
	NEG 50300 S	110	6,02	4,08	2.972	2.900	0,26	0,27	0,60	0,50	18,5	18,3	246	163	164	65	140	16	13	50
	NEG 50550 S	120	9,99	6,48	4.930	4.606	0,45	0,50	0,80	0,75	30	29,8	283	191	217	100	180	25	18	62,5
	NEG 50770 S	130	15,59	10,40	7.695	7.392	0,65	0,685	1,10	1,00	36	35	308	198	220	100	180	20	19	63
	NEG 50980 S	133	19,8	13,2	9.772	9.382	1,00	1,20	1,70	1,60	40	39	324	207	220	100	180	20	19	76
	NEG 501140 S		23,0	16,5	11.352	11.727					40,5	39,5								
1500 1800	NEG 2530 S	101	2,4	2,4	296	426	0,085	0,095	0,21	0,20	11,2	10,9	207	139	164	65	140	18	13	44
	NEG 2570 S		6,2	4,2	766	747					12,3	11,9	243							
	NEG 25210 S	110	16,84	11,76	2.078	2.090	0,17	0,17	0,41	0,40	20,5	19,5	306	163	164	65	140	16	93	80
	NEG 25420 S	120	32,64	22,66	4.028	4.027	0,30	0,35	0,60	0,60	34	33	356	191	217	100	180	25	111	99
	NEG 25540 S		43,60	32,64	5.405	5.800					36	35	392							
	NEG 25700 S	130	57,18	41,89	7.056	7.444	0,525	0,685	0,92	0,98	43	42	392	198	220	100	180	20	107	105
NEG 25930 S	133	75,0	52,0	9.254	9.239	0,55	0,68	0,95	0,95	49	47	452	207	220	100	180	20	115	140	
1000 1200	NEG 1630 S	110	6,02	6,02	331	476	0,12	0,135	0,30	0,30	20	20	246	163	164	65	140	16	13	50
	NEG 1690 S		16,84	16,84	924	1.330					21	21	306							
	NEG 16190 S	120	32,64	32,64	1.790	2.578	0,185	0,205	0,50	0,50	34	34	356	191	217	100	180	25	18	99
	NEG 16310 S	130	57,18	41,89	3.136	3.309	0,35	0,38	0,72	0,68	42,5	41,5	392	198	220	100	180	20	19	105
	NEG 16410 S	133	75,0	52,0	4.113	4.106	0,35	0,38	0,75	0,67	49	48	452	207	220	100	180	20	19	140
	NEG 16500 S		90,7	66,5	4.974	5.251					0,42	0,46								
750 900	NEG 12100 S	120	32,64	32,64	1.007	1.450	0,23	0,25	0,85	0,76	34	34	356	191	217	100	180	25	18	99
	NEG 12180 S	130	56,8	56,8	1.752	2.523	0,35	0,38	1,10	1,05	42	42	392	198	220	100	180	20	19	105
	NEG 12230 S	133	75,0	75,0	2.314	3.332	0,28	0,30	0,60	0,68	49	49	452	207	220	100	180	20	19	140



Container



Conveyor channel



Sieving channel

### Applications

The electric external vibrators of the NEG S series are used wherever special demands are made on the chemical resistance of the surfaces. Even in the standard version, the NEG S have a surface quality RZ of 6,3 µm and therefore meet the requirements of the chemical and pharmaceutical industries. A higher surface quality, e.g. for the food industry, is easily possible on request. The

protection class IP 66 allows intensive cleaning with high-pressure lamps and aggressive cleaning agents.

### Design and function

One special feature of the NEG s series is in its modular design. As a result, even very small series in different steel materials can be produced economically. All internal com-

ponents of the NEG S vibrators come from the proven NEG series and are tried and tested.

Stainless steel housings usually have a higher tare weight than the standard housing. This larger mass is to be considered in the design.

## Netter Stainless Steel Electric External Vibrators NES Series

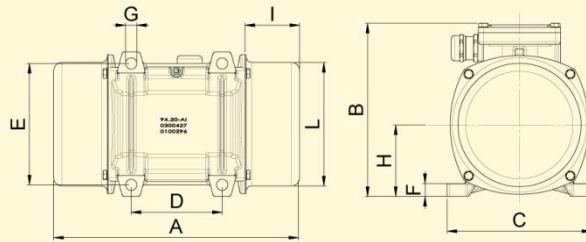

min <sup>-1</sup>	Type	Unbalance [cmkg]		Centrifugal force [N]		Nominal power [kW]		Nominal current [A]		Weight [kg]		Dimensions [mm]							
		50 Hz	60 Hz	50 Hz	60 Hz	50 Hz	60 Hz	50Hz 400V	60Hz 480V	50 Hz	60 Hz	A 50/60Hz	B	C	D	E	F	G	I 50/60 Hz
3000 3600	NES50120	2,4	2,4	1.185	1.706	0,18	0,18	0,35	0,30	7,8	7,8	209	151	125	62-74	106	10	9	45
	NES50200	4	3,2	1.974	2.274					8,2	8,0	225							53
	NES50300	6	4	2.961	2.843	0,26	0,27	0,60	0,50	12,5	12,0	255	176	152	90	125	12	13	54
	NES50550	11,5	6,9	5.676	4.904	0,45	0,50	0,80	0,75	18,5	17,5	284	200	167	105	140	15	13	63
	NES50770	14,7	11	7.255	7.818	0,65	0,69	1,10	1,00	25,0	24,0	308	205	205	120	170	17	17	63
	NES501140	22,4	14,7	11.056	10.448	1,00	1,20	1,75	1,75	30,0	29,0	354	232	205	120	170	20	17	77
	NES501540	31	21	15.300	14.925	1,40	1,45	2,30	2,00	39,6	38,0	438	245	230	140	190	25	17	103
NES502020	41	26	20.236	18.479	2,20	2,20	3,50	3,00	48,7	46,3	438	245	230	140	190	25	17	103	
1500 1800	NES2530	2,4	2,4	296	426	0,09	0,10	0,21	0,20	7,8	7,8	209	151	125	62-74	106	10	9	45
	NES2570	6,4	4,8	790	853					9,0	8,7	225							53
	NES25100	7,78	6,20	960	1.102	0,09	0,10	0,21	0,20	9,4	9,0	241/225	151	125	62-74	106	10	9	61/53
	NES25210	16,8	11,8	2.073	2.097	0,17	0,17	0,41	0,40	15,8	15,0	295	176	152	90	125	12	13	74
	NES25420	32,6	22,7	4.023	4.033					22,5	21,7	340							91
	NES25540	43,8	32,6	5.404	5.792	0,30	0,35	0,60	0,60	23,9	22,5	380	200	167	105	140	15	13	111
	NES25700	57,2	41,9	7.058	7.445	0,53	0,67	0,92	0,98	32,0	30,7	378	211	205	120	170	17	17	98
	NES251030	83	54,2	10.242	9.630	0,55	0,68	0,95	0,95	42,0	37,5	436	232	205	120	170	20	17	118
	NES251410	112	80	13.820	14.215	0,90	1,05	1,45	1,50	53,0	50,0	442	245	230	140	190	25	17	105
	NES251800	143	97	17.645	17.235	1,10	1,20	2,00	1,90	58,5	54,5	490	245	230	140	190	25	17	129
	NES252060	163	112	20.113	19.900	1,35	1,45	2,50	2,30	70,0	68,0	560	245	230	140	190	25	17	164
	NES252370	192	135	23.691	23.987	1,60	1,70	3,20	3,00	82,0	76,0	525	285	275	155	225	30	22	131
	NES253050	247	172	30.477	30.561	1,90	2,00	3,80	3,50	92,0	89,0	601	285	275	155	255	30	22	135
	NES253720	302	207	37.264	36.780	2,20	2,50	3,90	3,90	115,0	110,0	589	323	310	155	255	35	23,5	139,5
NES254310	344	235	42.446	41.684	2,50	2,80	4,80	4,65	122,0	117,0	589	323	310	155	255	35	23,5	178	
1000 1200	NES1630	6	6	329	474	0,12	0,14	0,30	0,30	12,5	12,5	255							54
	NES1690	16,8	16,8	921	1.327					15,8	15,8	295	176	152	90	125	12	13	74
	NES16190	32,6	32,6	1.788	2.574	0,19	0,21	0,50	0,50	22,5	22,5	340	200	167	105	140	15	13	91
	NES16310	57,2	41,9	3.137	3.309	0,35	0,38	0,72	0,68	32,0	30,7	378	211	205	120	170	17	17	98
	NES16410	75	52	4.113	4.106	0,35	0,38	0,75	0,68	43,5	43,5	434	232	205	120	170	20	17	117
	NES16810	144	112	7.897	8.845	0,68	0,76	1,40	1,35	54,0	52,6	490/442	245	230	140	190	25	17	129/105
	NES161130	202	143	11.078	11.293	0,75	0,75	1,65	1,50	67,0	59,5	560	245	230	140	190	25	17	164
	NES161420	254	187	13.929	14.767	0,95	1,00	2,10	2,00	78,0	71,0	560	245	230	140	190	25	17	164
	NES161610	293	192	16.068	15.162	1,10	1,30	2,20	2,20	94,0	83,0	601/525	285	275	155	225	30	22	169/131
	NES162110	385	264	21.113	20.848	1,50	1,70	3,00	2,90	105,0	93,0	601	285	275	155	225	30	22	169
	NES162550	464	323	25.446	25.507	1,96	2,10	4,10	3,75	130,0	116,0	657/589	323	310	155	255	35	23,5	173,5/139,5
NES163030	553	400	30.327	31.588	2,20	2,40	4,50	4,30	145,0	130,0	705	323	310	155	255	35	23,5	197,5	
750	NES12100	32,64	32,64	1.007	1.450	0,23	0,25	0,85	0,76	22,5	22,5	340	200	167	105	140	15	13	91
	NES12180	56,80	56,80	1.752	2.523	0,35	0,38	1,10	1,05	32,0	32,0	378	211	205	120	170	17	17	98

### Applications

The stainless steel electric external vibrators of the NES series are mainly used in the chemical, pharmaceutical and food industries. They serve as drives for conveyors, sieves and discharge aids. The stainless steel surfaces of the vibrators are particularly resistant to chemically aggressive environmental conditions and can be thoroughly cleaned mechanically and automatically with powerful cleaning agents.

The extremely resilient roller bearings guarantee a long service life. All NES are suitable for operation on Netter frequency converters.

### Design and function

Stainless steel electric external vibrators are three-phase asynchronous motors with adjustable unbalances on both shaft ends, which generate a sinusoidal vibration with the frequency of the corresponding number of rotations.





# NetterVibration

## Netter High Frequency Electric External Vibrators NEG/NEH Series



NEG



NEH

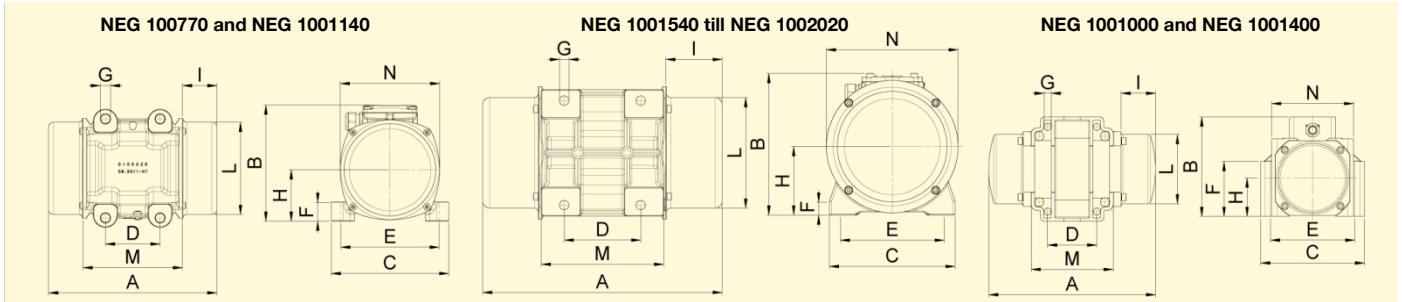

min <sup>-1</sup>	Type	Unbalance [cmkg]	Centrifugal force [N]	Nominal power [kW]	Nominal current [A]			Weight [kg]	Dimensions [mm]												
					400 V 100Hz	42V 200Hz	250 V 200Hz		A	B	C	D	E	F	G	H	I	L	M	N	
0 – 6000	NEG 100770	3,68	7.255	0,65	1,1	-	-	22,1	308	212,5	226	100	180	35	17	93,5	63	168	162	193	
	NEG 1001000	5,07	10.000	1,1	-	18,5	3,15	14,8	307	181	190	90/120	154/120	99/141	13/16,5	70,0	65,5	126	176	136	
	NEG 1001140	5,6	11.056	1	1,75	-	-	25,0	314	217	217	100	180	35	17	93,5	76	168	152	193	
	NEG 1001400	7,09	14.000	1,1	1,8*	18,5	3,15	15,2	307	181	190	90/120	154/120	99/141	13/16,5	70,0	65,5	126	176	136	
	NEG 1001540	7,75	15.300	1,4	2,3	-	-	34,3	438	257	230	140	190	25	17	124,5	103	201	224	241	
	NEG 1001800	9,00	17.768	2	3,3	-	-	35,1	438	256	230	140	190	25	17	124,5	103	201	224	241	
	NEG 1002020	10,25	20.236	2,2	3,5	-	-	49,0	458	233,5	230	140	190	22	17	104	101,5	183	247	224	
			<b>Bracket</b>																		
		NEH 100600	3,03	5.980	0,5	1	9,5	1,6	8,0	255	140	97	97	180	NVH 1		54	124	-	141	
		NEH 1001140	5,42	10.700	1,2	2	23	3,85	21,0	289	189	83	140	240	NVH 4		63	170	-	182	
	NEH 1001540	7,80	15.400	1,7	4,8	29	4,9	23,0	289	189	83	140	240	NVH 4		63	170	-	182		
	NEH 1002020	9,92	19.600	1,7	2,9	27	4,5	28,0	375	189	83	140	240	NVH 4		106	170	-	179		

\* At same voltage 200 Hz

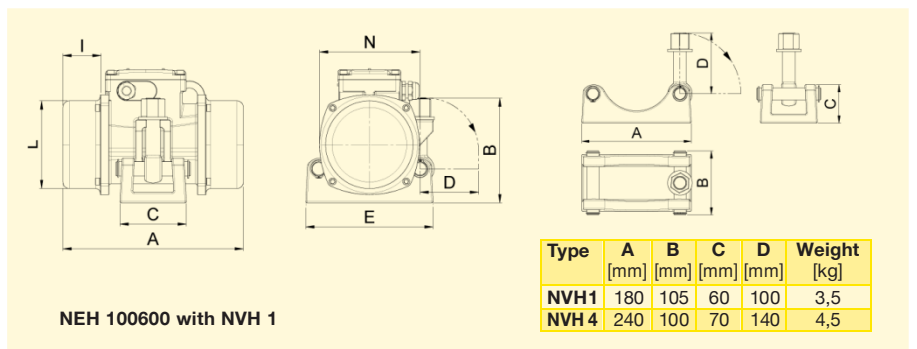

NEH 100600 with NVH 1

### Applications

The Netter high-frequency electric external vibrators of the series NEG/NEH were specially developed for concrete compaction on formwork in precast plants and in tunnel construction. A frequency of up to 6.000 min<sup>-1</sup> and a robust design help solve the most difficult applications in the construction industry.

### Design and function

Electric external vibrators are unbalance motors according to the short circuit rotor principle. On both ends of the shaft there are adjustable unbalances that generate a sinusoidal vibration at a rate of rotation of the corresponding frequency.

The NEG series differs from the NEH series in its method of mounting.

NEG vibrators are mounted with Netter NBS fastening kits.

NEH vibrators are fastened with the Netter quick clamp mounts of the NVH series. This allows easy transfer of the units.

All NEG/NEH are optimised for operation on Netter frequency converters and voltage transformers.

## Netter Electric External Vibrators Special versions

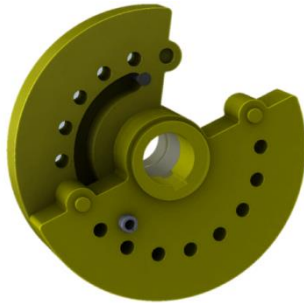

### CC Unbalances

#### Applications

This special version with CC unbalances is used if two different unbalance settings are to be at a disposal during operation.

The CC unbalances are manufactured on customer request and allow a second unbalance setting of 25-100% of the main value.

#### Design and function

To use the CC unbalances, the NEG must be operable by a corresponding electrical circuit in both directions of rotation. If the NEG turns in one direction, it works e.g. with a maximum unbalance.

When the direction of rotation changes, the outer unbalance disc automatically rotates at a specified angle against the inner unbalance disc and thus provides a reduced unbalance setting.



### Shaft Coupling

#### Applications

This special version with shaft coupling is used when large centrifugal forces are necessary, but little space is available for installation.

#### Design and function

Two or more vibrators in series are operated with angular synchronous unbalances by connecting the shafts of the vibrators via a shaft coupling.

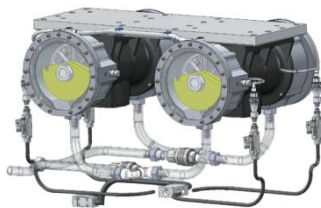

### Oil Circulating Lubrication

#### Applications

This special version with external oil circulating lubrication is recommended when operating high frequency vibrators continuously, which would lead to major heating and a reduced bearing life.

#### Design and function

A hydraulic pump continuously supplies the bearings with oil during operation, which flows back into the oil tank via a cooler.



### Rotary Encoders

#### Applications

These special versions with rotary encoders are always used when the frequency and/or position of the unbalance is to be detected electronically. This enables the building of complex vibration systems.

#### Design and function

The external electric vibrators are equipped with a special mounting system for rotary encoders. Robust rotary encoders with integrated, highly elastic and a torsionally stiff hollow shaft coupling measure the frequency of the vibrator even under the toughest operating conditions.



SRF



ATV



NFU

## Netter Electric External Vibrators Accessories

### Static adjustable frequency converters

#### ATV 320 / NFU Series

#### Static adjustable frequency controls

#### SRF Series

#### Applications

The frequency control of the SRF series and the frequency inverters of the series ATV and NFU are used to control the frequency of electric vibrators.

Special applications require frequencies that cannot be achieved with normal multiple vibrators at mains frequency. The special feature of this frequency converter is its robust and uncomplicated design.

#### Design and function

SRF frequency controllers are mounted in a control cabinet with a degree of protection of IP 54. ATV units are frequency converters in the IP 2x housing and are intended for switch cabinet installation at the customer. The performance data correspond to the SRF series.

NFU units are frequency converters with a motor circuit in an IP 54 housing for wall mounting and are equipped with a main switch, a rotational direction switch and a setpoint potentiometer.



# NetterVibration

## Netter Electric External Vibrators Accessories



### Netter On-Off Switch

#### Applications

With the Netter on-off switches, one or two electric external vibrators of the NEG or NEA series can be connected directly to the system or decentralized, e.g. be switched on or off from a control room.

#### Design and function

Depending on the material, the switches are integrated in a housing with a degree of protection of IP 55 or IP 65. Large control buttons allow easy operation. The main emergency stop switch is lockable. Versions with motor protection switch are available.



### Netter Brake Units BZ Series

#### Applications

Brake units of the BZ series are used to bring the NEG as quickly as possible to a standstill during operation.

In order to avoid resonance phenomena of vibration tables and of conveyors, it is often necessary to be able to switch off drives without their running down uncontrollably.

A special feature of these units is the very high braking effect with a compact size.

#### Design and function

The load-resistant power electronics changes the direction of the electric rotating field when the brake is actuated, bringing the NEG immediately to a standstill. The short-term high braking currents can be easily handled by the NEG. The permissible temperature range is between 0 °C and +40 °C, degree of protection is IP 23. The braking devices are only suitable for stable mains frequencies of 50 Hz or 60 Hz. Operation together with a frequency converter is not permitted.

## Netter Vibration Monitoring Systems

### Series *VibroMonitor*



#### Applications

The vibration monitoring system of the series *VibroMonitor* is used for the constant monitoring of impactors, vibrators and vibration systems.

The *VibroMonitor* system reliably monitors the functioning of vibrators and impactors, even in hard-to-reach places.

#### Design and function

The monitoring system consists of a sensor, a connection cable and a controller. The controller ensures safe data transmission of the sensor signal up to a max. distance of 250 m. Depending on the version, one controller can steer up to 4 sensors. The controller can be mounted on a standard M36 DIN rail.



### Safety Cable Series NSE

#### Applications

The safety cables of the NSE series prevent the external electric vibrators from falling down if they accidentally come loose.

The use of safety cables is recommended, especially in critical installation situations, e.g. at high altitudes.



### Fastening Kits Series NBS

#### Applications

The NBS series fastening kits are for the safe and permanent attachment of the electric external vibrators and are sized to exactly match the foot height of the housings.

They are available in different designs, among others in stainless steel in the appropriate strength category.

**NetterVibration** has a worldwide network of experienced dealers and application technicians who are happy to solve problems, also on-site, together with you or your customers with the help of vibration technology.

**Netter provides solutions. Consult our experienced application technicians.**

#### Netter GmbH

##### Germany

Fritz-Ullmann-Str. 9  
55252 Mainz-Kastel  
Tel. +49 6134 2901-0

##### Poland

Al. W. Korfantego 195/17  
40-153 Katowice  
Tel. +48 32 2050947

#### Switzerland

Erlenweg 4  
4310 Rheinfelden  
Tel. +41 61 8316200

##### Spain

Errota Kalea 8  
20150 Villabona-Guipúzcoa  
Tel. +34 943 694 994

www.**NetterVibration**.com  
info@**NetterVibration**.com