

Filterlüfter **LS 3**

Filter Fan



LS 3 K



LS 3 (K)



LS 3

Technische Daten / Technical data:						
Type:	LS 3					
Spannung Voltage	230 V 50/60 Hz		115 V 50/60 Hz		400 V 3~ (*) 50/60 Hz	
Förderrichtung Air flow	blasend blowing	saugend sucking	blasend blowing	saugend sucking	blasend blowing	saugend sucking
Stromaufnahme Amperage	0,51/0,70 A	0,51/0,74 A	1,05/1,47 A	1,02/1,40 A	0,22/0,26 A	0,22/0,26 A
Leistung Power input	115/165 W	115/175 W	120/175 W	115/166 W	110/150 W	110/150 W
Drehzahl Speed	2550/2750 min ⁻¹		2450/2650 min ⁻¹		2650/2900 min ⁻¹	
Temperaturbereich Temperature range	-10...+50°C					
Lebensdauer Service life	40.000 h					
Schallpegel Noise level	70 dB (A)					
Zulassung Approval	UL, CE				CE	
Farben colours	RAL 7032 (Standard), RAL 7035 (nur/ only K)					
Schutzart Degree of protection	IP 54 (mit Dichtung / with gasket)					
Luftfördermenge / Air flow: (m³/h)						
Filtermatte Filter mat	P15/350S		P15/500S		P15/350S + T3/290S	
Luftleistung freiblasend Air flow free air	730		580		380	
mit Austrittsfilter LG 13 with exhaust filter	555		450		320	

Saugende Ausführung separat bestellen!
Suction version to be ordered separately!

Zubehör / **Accessories:**

Austrittsfilter / Exhaust filter
Dichtung / gasket
Ersatzfiltermatte / Replacement filter mat
Thermostate / Thermostats

LG 13 (K)
D 13
AM 1335P, AM 13P, AM 13T
TRS 60, TRW 60, TWR 60, TKW 60

(*)
Bei 3 ~ Ausführung muss als Vorsicherung ein Motorschutzschalter verwendet werden. Der Einstellwert darf max. 10% über dem Nennstrom des Lüfters liegen.

A motor circuit switch is necessary for protection of the 3 ~ version. The adjustment may not be higher than 10% above the nominal current of the fan.

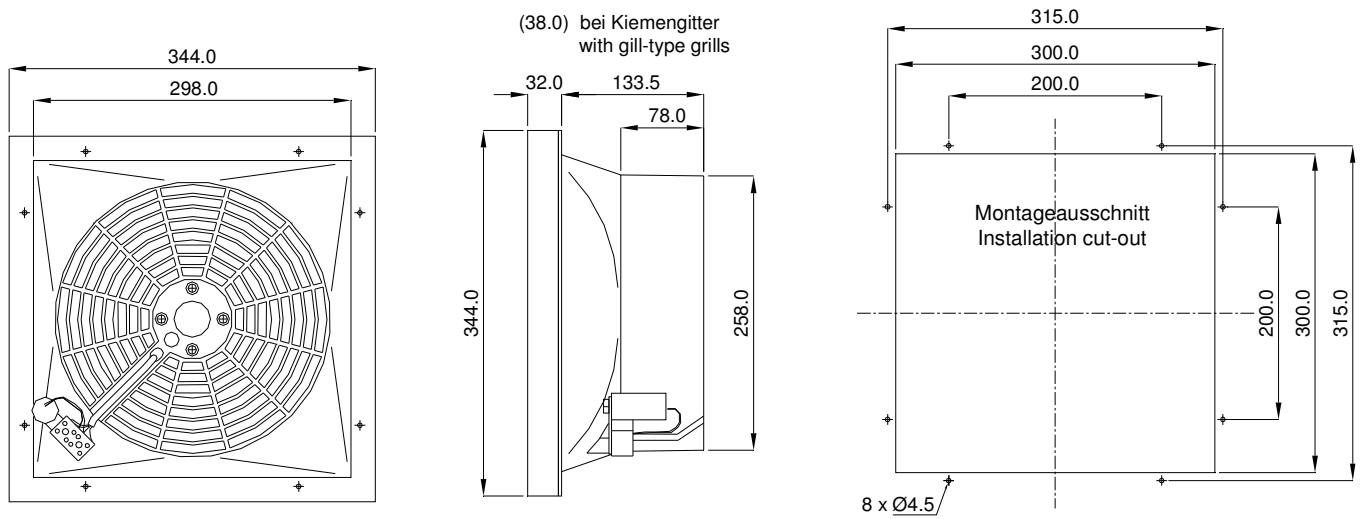

Leistungsdiagramm
Performance diagram

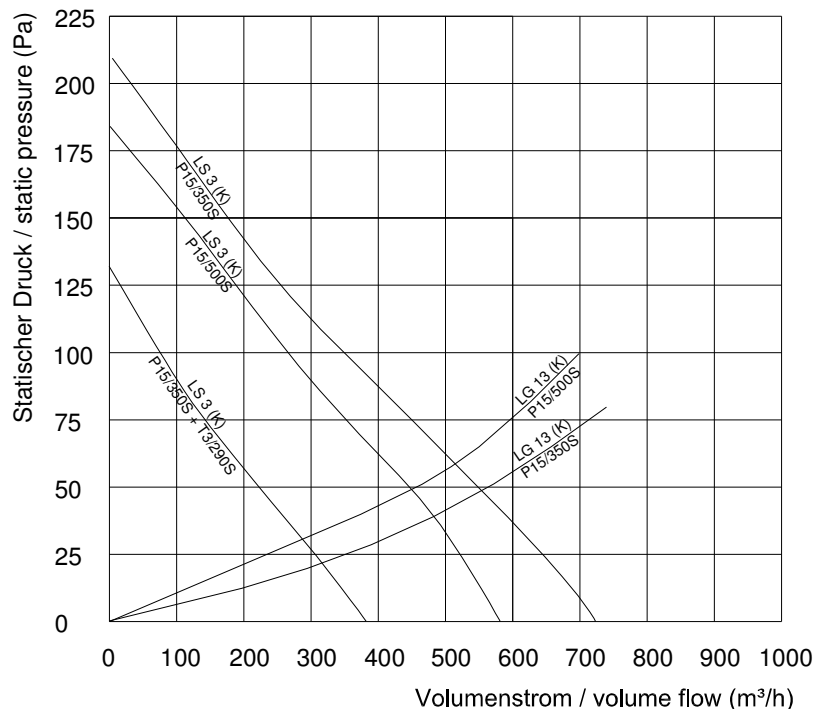

Rev. 01/16