

Differential pressure switch for air, flue and exhaust gases

LGW...A2, LGW...A2P
LGW...A2-7

DUNGS[®]
Combustion Controls

5.13

neuvità
nouveau new

LGW...A2, LGW...A2-7

• RoHS II 2011/65/EU



Technical description

The differential pressure switches LGW...A2... are adjustable differential pressure switches as per EN 1854 for automatic burner controls.

Suitable for switching a circuit on, off or over on changes in actual pressure value relative to the set reference value.

The reference value (switching point) is adjusted on a setting wheel provided with a scale. On LGW...A2P: test button integrated in lower part as standard.

Application

Differential pressure monitoring in firing, ventilation and air-conditioning systems. Suitable for air, flue and exhaust gases and other non-aggressive gases as differential pressure switches; not suitable for industrial combustion gases.

Approvals

EC type test approval as per EC Gas Appliance Directive:

CE-0085 AQ 0673

EC type test approval as per EC Pressure Equipment Directive:

CE0036

Pressure switch class "S" as per EN 1854.

Special designs for the North American market with UL, FM and CSA registrations.

Approvals in other important gas-consuming countries.

Functional description

Differential pressure switch in pressure and vacuum range. The differential pressure acts via the diaphragm against the force of the setting spring on the microswitch. The pressure switch operates without auxiliary power.

Differential pressure switch

The control unit responds to differential pressure. If the set reference value (mbar) is exceeded or undershot, the circuit is switched on, off or over.

LGW...A2P test button

The LGW...A2P differential pressure switch is equipped with a test button. The test button permits a service-friendly check of the safety function. If the test key is pressed while the pressure exists, the connection to the pressure connection **G 1/4** is interrupted and the pressure under the diaphragm is released. The microswitch of the pressure switch changes the contact position from NO to NC. If the test button is released, the pressure below the diaphragm is built up again and the microswitch changes to its original position.

Switching function

As pressure rises:

1 NC opens, 2 NO closes

As pressure falls:

1 NC closes, 2 NO opens

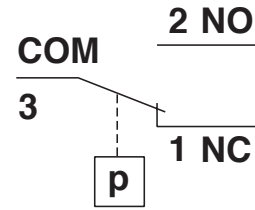

Definition of switching difference Δp

The switching difference Δp is the pressure difference between the upper and lower switching pressures.

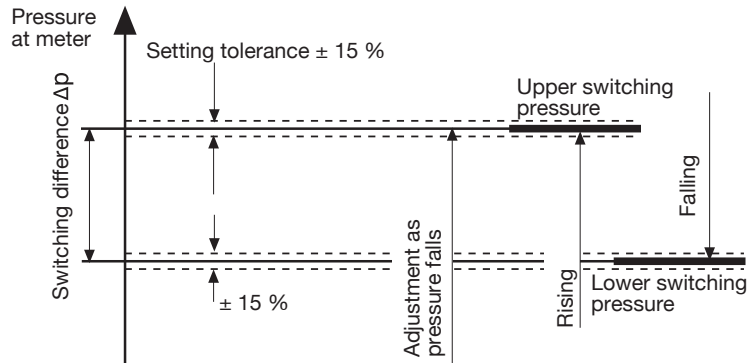

Dimensions [mm] LGW...A2, LGW...A2-7

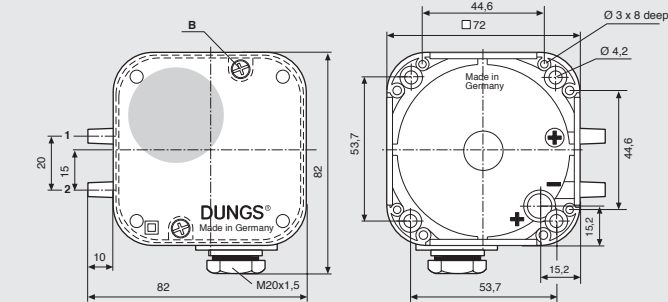
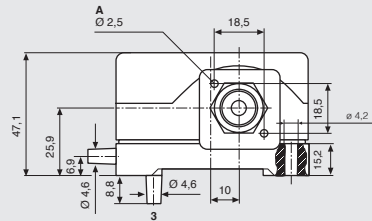

LGW...A2P

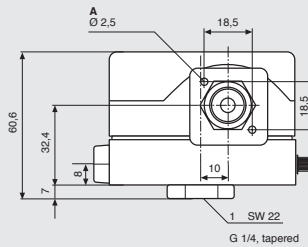

Pressure connection (+) $\varnothing 4.6$ can only be used as test nipple. Pressure connection only possible using G 1/4.

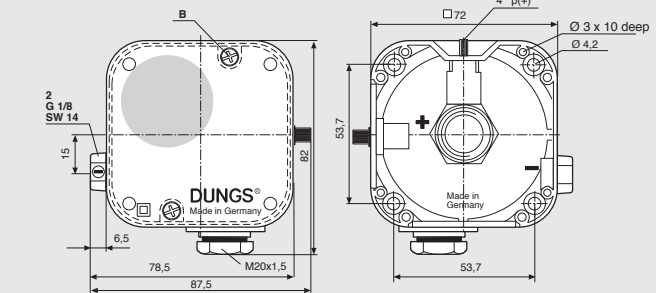

- A 2.5 dia for equipment plug as per DIN EN 175 301-803
- B Oblong slot: 0.8 and cross-head as per DIN 7962-Z 2
- 1 Pressure connection (+)
- 2 Pressure connection (-)
- 3 Only LGW... A2 optional pressure connection (+)
- 4 Test button p (+)

Specifications

Max. operating pressure	LGW 3 A2 - LGW 150 A2 LGW 3 A2P - LGW 150 A2P LGW 1,5 A2-7 - LGW 30 A2-7	500 mbar (50 kPa) 500 mbar (50 kPa) 100 mbar (10 kPa)		
Ranges	LGW...A2, ...A2P 0.4 - 3 mbar 1 - 10 mbar 2.5 - 50 mbar 30 - 150 mbar	LGW...A2-7 20 - 150 Pa 20 - 300 Pa 30 - 600 Pa 0.1 - 1 kPa 0.2 - 3 kPa		
Pressure connection	LGW...A2, LGW...A2-7: hose gland \varnothing 4.6 mm LGW...A2P: G 1/4 tapered female thread for higher pressure on centre of housing underside, including test button and on the side 4.6 dia. test point; G 1/8 female thread for lower pressure.			
Temperature range	Ambient temperature Medium temperature Storage temperature	LGW...A2, LGW...A2P -15 °C bis +70 °C -15 °C bis +70 °C -30 °C bis +85 °C	LGW...A2-7 -15 °C bis +85 °C -15 °C bis +85 °C -30 °C bis +85 °C	
Materials	Housing Switch Diaphragms Switching contact	Polycarbonat Polycarbonat NBR LGW...A2, A2P Ag, optional Ag gold plated (Au) LGW...A2-7 Ag, gold plated (Au) Au contacts are suitable for DDC applications: DC 24 V; 0.01 A		
Switching voltage	Ag contact Au contact	AC eff. DC DC	min. 24 V min. 24 V min. 5 V	max. 250 V max. 48 V max. 24 V
Nominal current	Ag contact LGW...A2, A2P Ag contact LGW...A2-7 Au contact	AC eff. AC eff. DC	10 A 6 A 20 mA	
Switching current	Ag contact LGW...A2, A2P Ag contact LGW...A2, A2P Ag contact LGW...A2-7 Ag contact LGW...A2-7 Au contact	AC eff. at $\cos \varphi$ 1 AC eff. at $\cos \varphi$ 0,6 AC eff. at $\cos \varphi$ 1 AC eff. at $\cos \varphi$ 0,6 DC DC	min. 20 mA min. 20 mA min. 20 mA min. 20 mA min. 20 mA min. 5 mA	max. 6 A max. 3 A max. 4 A max. 2 A max. 1 A max. 20 mA
Electrical connection	Standard Special design	At screw terminals via M20x1.5 cable entry Plug connection for line sockets as per DIN EN 175 301-803, 3-pin		
Degree of protection	IP 54 IEC 529 (EN 60529), protection insulated, optional IP 65			
Setting tolerance	\pm 15 % switching point deviation, relative to nominal value, with vertical mounting position. Rising (\uparrow) or falling (\downarrow) setting available on site.			
Deviation	Permissible deviation of the set value $\leq \pm$ 15 % in the service life test according to EN 1854			

Installation position

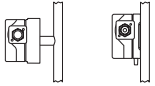
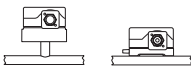
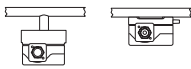
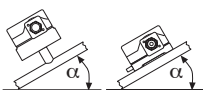
	Standard installation position \pm 0 mbar or \pm 0 Pa
	Installed horizontally ca. +0,5 mbar or +50 Pa
	Horizontally overhead ca. -0,5 mbar or -50 Pa
	Intermediate installation position max \pm 0,5 mbar or \pm 50 Pa

Differential pressure switch for air,
flue and exhaust gases

LGW...A2, LGW...A2P
LGW...A2-7



Technical data 1 mbar = 100 Pa = 0,1 kPa ≈ 10 mm WS 1 Pa = 0,01 mbar ≈ 0,1 mm WS

Type	Version [AG-M-V9]	Order No. 1 piece	Order No. 60 pieces	Setting range		min. / max.		Switching difference [mbar]
				[mbar]				
LGW...A2 Differential pressure switch	LGW 3 A2	272 337	107 409	0,4 - 3		± 0,1	± 15 %	
	LGW 10 A2	272 336	107 417	1 - 10		± 0,2	± 15 %	
	LGW 50 A2	272 341	107 425	2,5 - 50		± 0,75	± 15 %	
	LGW 150 A2	272 356	107 433	30 - 150		-	± 15 %	
LGW...A2P Differential pressure switch	LGW 3 A2P	272 352	120 204	0,4 - 3		± 0,1	± 15 %	
	LGW 10 A2P	272 345	120 212	1 - 10		± 0,2	± 15 %	
	LGW 50 A2P	272 346	221 207	2,5 - 50		± 0,75	± 15 %	
	LGW 150 A2P	272 354	120 238	30 - 150		-	± 15 %	
Typ	Version [AU-M-V9]	Order No. 1 piece	Order No. 60 pieces	Setting range		min. / max.		Switching difference [Pa]
				[Pa]				
LGW...A2-7 Differential pressure switch	LGW 1,5 A2-7	257 434	257 434	20 - 150		± 8	± 15 %	
	LGW 3 A2-7	257 435	257 435	20 - 300		± 8	± 15 %	
	LGW 6 A2-7	257 436	257 436	30 - 600		± 10	± 15 %	
	LGW 10 A2-7	257 437	257 437	0,1 - 1 kPa		-	± 15 %	
	LGW 30 A2-7	257 438	257 438	0,2 - 3 kPa		-	± 15 %	

**Accessories for
LGW...A2, LGW...A2P**

Kit: G3 equipment plug, 3-pin without ground	231 770
Line socket, 3-pin + E, grey GDMW	210 318
KlimaSet accessories KS A2-7	258 247
G 1/8 screw-in gland	230 278
G 1/4 screw-in gland	230 279
Additional test button, complete PT 4	224 940
Attachment plate	230 301
Mounting kit glow lamp 230 V yellow	231 773
Mounting kit glow lamp 120 V yellow	231 772
Mounting kit display-LED 24 V yellow	231 774
Mounting kit glow lamp 230 V green	248 239
Mounting kit display-LED 24 V yellow	248 240
Replacement-set hood IP 65	257 841
Adapter ø 4/6 (2 x)	266 037
Cylinder head screw ø 3 x 14 (2 x)	266 045

We reserve the right to make any changes in the interest of technical progress.



Head Offices and Factory
Karl Dungs GmbH & Co. KG
Siemensstraße 6-10
D-73660 Urbach, Germany
Telephone +49 (0)7181-804-0
Telefax +49 (0)7181-804-166

Postal address
Karl Dungs GmbH & Co. KG
Postfach 12 29
D-73602 Schorndorf, Germany
e-mail info@dungs.com
Internet www.dungs.com