



Main Catalog



Kraus & Naimer



QUALITY & INNOVATION SINCE 1907.

Since 1907 Kraus & Naimer focused on developing, manufacturing and distributing switches for low voltage applications.

Only consequent specialization enables state of the art products on a highest technical quality level. The world's first programmable cam switch already was branded with the Kraus & Naimer Φ .

Today worldwide recognized and synonym for safe switching solutions and path braking innovation.

In no time Kraus & Naimer emerged to the market leader of cam switches and is moreover one of the leading manufacturer for main disconnects. The wide and global oriented product portfolio Offers a technical and economical optimized solution for nearly every application.

WE CONSULT YOU INDIVIDUAL & PERSONALLY

Perfect service

is the interface to our customers.

Therefore we invest time and our long-term expertise in consulting you. Our team answers individually and competently your questions.

On page 215 of our main catalog or our website www.krausnaimer.com you will find the contact persons of our branches worldwide.

HUMAN MACHINE INTERFACE

More and more, the HMI is getting into the focus of end users and manufacturers – whether in building automation systems, general mechanical engineering or in special applications, such as the food and beverage processing industries.

Our various product series with powerful devices and the latest software technology make it easy to get started with IoT/IIoT. Robust industrial standard products in a sophisticated design combining functionality and aesthetics.

For more information, see page **6, 45, 88, 170 und 186.**

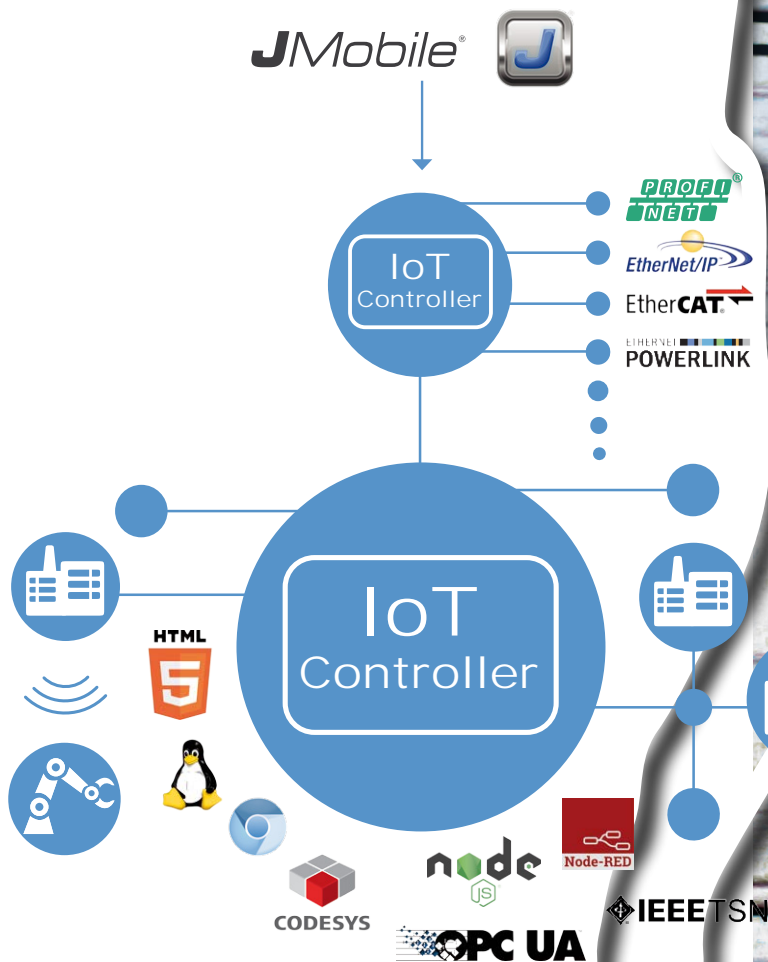

CONTENT



Main, Safety and
Maintenance Switches

7



Control Switches
and Load Switches

5

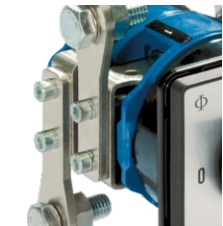

Switches for specific use
and DC Switches

171



Push Buttons and Pilot Lights

187

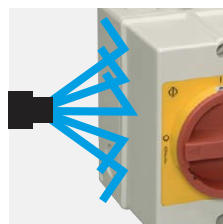
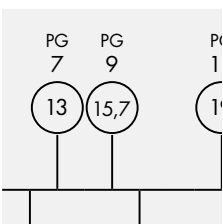

Useful Information

204

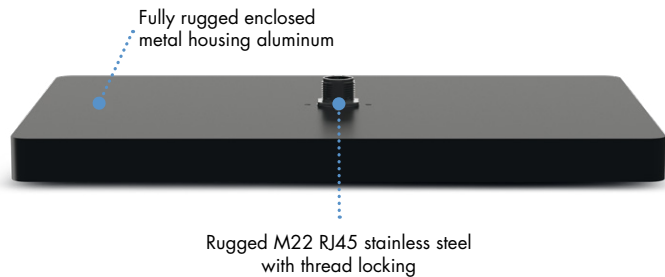

The web-based powerful IoT panel for industry 4.0

- TFT Superior optical performance
- RGB color status LED
- Black cover glass printing with minimal border
- Rugged projective capacitive multitouch touch panel 3,2 mm thickness tempered glass
- Contrast min. 500:1
- Web-Panel



Portrait and landscape screen orientation

Ultra rugged M22 flunch and panel mounting HMI system single RJ45 CAT-5 PoE cable and USB port

10-years availability guarantee

Field level installation HMI

M22 Human Machine Interface (Exor International patent)

Powerful CODESYS implementation

Visualization screens in pure last generation web browser technology/ OPC-UA or JMobile software

KN-C 700 Plug & Play

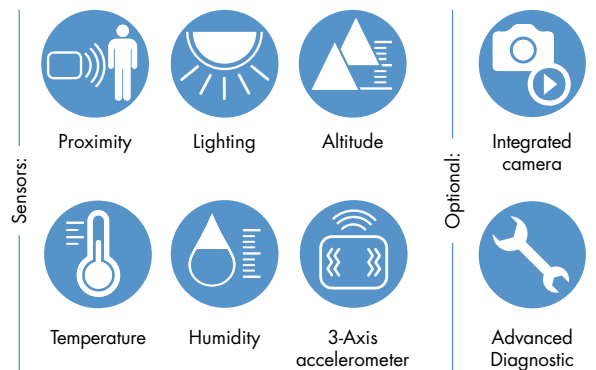
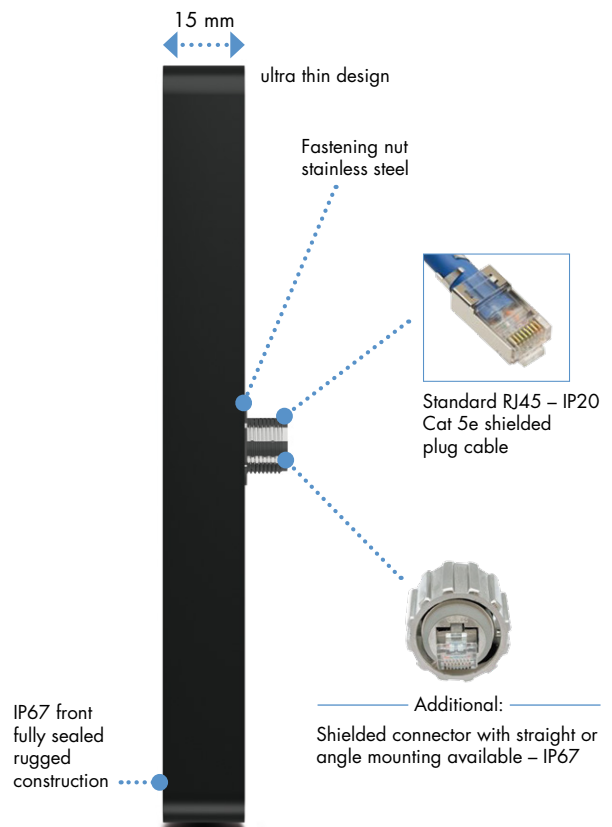

< Back to the catalog directory >

- ▶ Main Switches
- ▶ Safety Switches
- ▶ Maintenance
Switches

[← Back to the catalog directory](#)

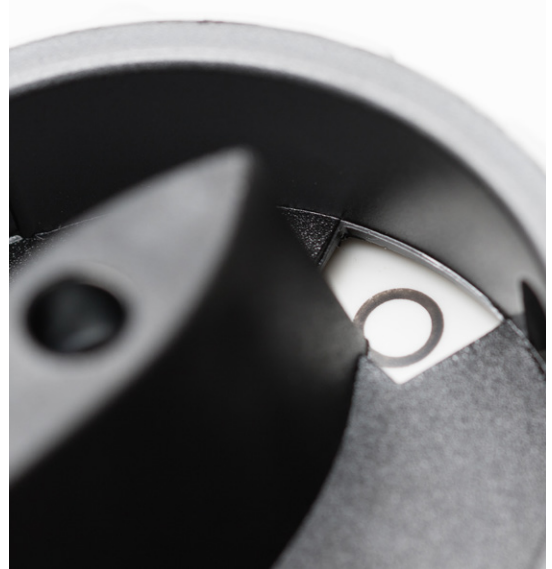



[Next >](#)

USEFUL INFORMATION

- Ordering example if a replacement is required -
The most important data you should know about ordering, in case of replacement.

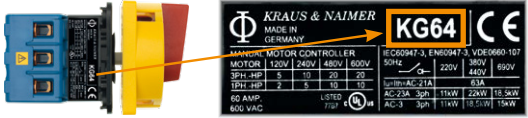
Labels until 2019

1. 

2. 

Labels from 2020

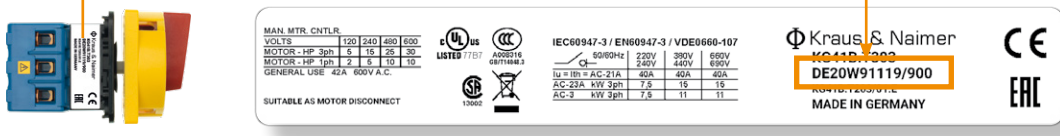

If this information is not (completely) available, we will ask for meaningful photos.

The variable block building system KG20-KG317 (not for KG10)

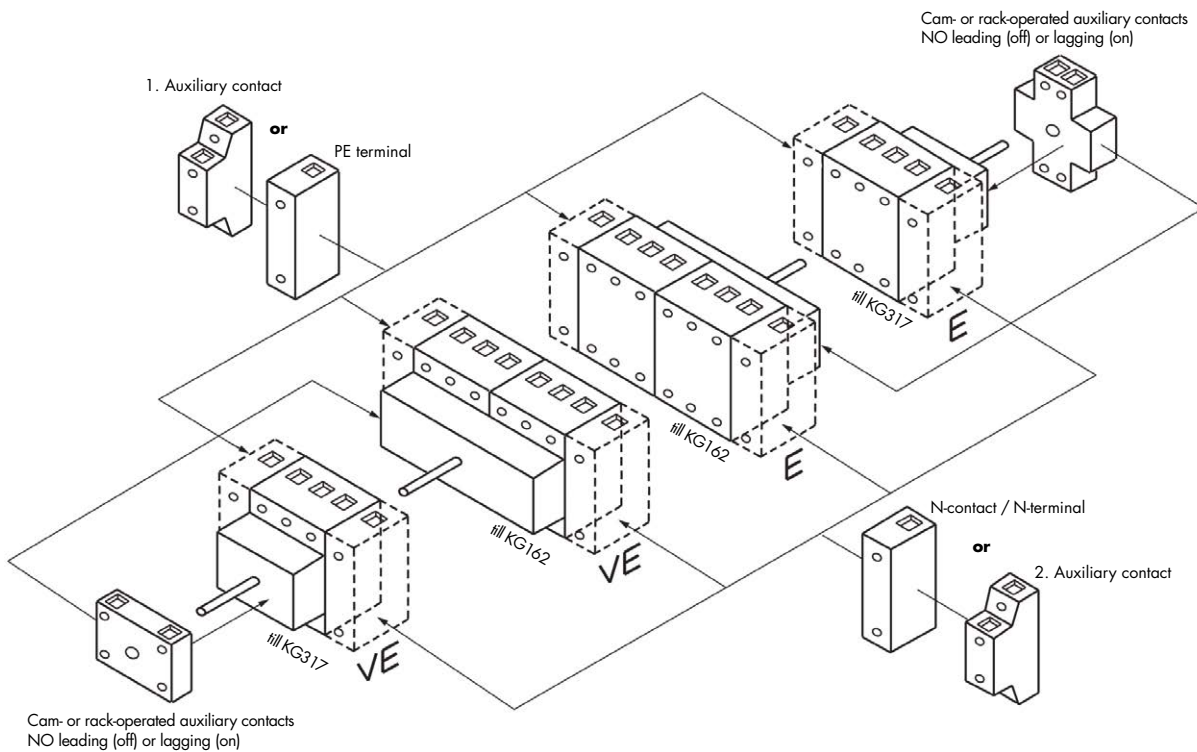

In general terms

The terminals of KG10-KG160 are according to EN 50274, protected against direct contact according to BGV A3 and IP20 (up to size KG64). In the package content of the Main and Safety Switches, range KG80 to KG160 is one protective cover included and in the range from KG210 to KG315 there are two protective covers included.



Complete items		
MAIN AND SAFETY SWITCHES		
Four hole panel mounting		10
Single hole mounting 22 mm		24
Base mounting and switch cabinet mounting with door clutch		34
MAINTENANCE SWITCH		
Plastic enclosures		46
For EMC-compliant connection		52
Safety switches Class 0		58
Stainless steel enclosures		60
Aluminium enclosures		63
ATEX		66
Safety switches Class 1		67
SWITCH DISCONNECTOR		
3 pole	Base mounting 45 mm standard knock-out, Four hole panel mounting, Single hole mounting	70
4 pole Double-throw switch	Base mounting 45 mm standard knock-out Four hole panel mounting, Base mounting with shaft extension	POWER – 0 – EMERGENCY POWER 1 – 0 – 2
		71
Additional variations up to 8 contacts possible on inquiry!		
Accessory		
Solder joint terminals, Auxiliary contacts, PE- and N-Terminals, N-contacts, Cam or rack operated auxiliary switches, additional PE-/N-terminals for KS- and KL- enclosures, Refit kit EMC		72
Protective covers, Terminals for control circuit, Connection aids		74
Bolt terminals		75
Accessory M700/., Accessory Single hole mounting, Mounting screws		76
Add-on escutcheon plates for main switches		77
Optional Extras for Customizing (available only in combination with a switch)		
Door clutch with four hole mounting (M280) for use in enclosures		78
Padlock device with integrated door clutch for control door clutch (M700) for use in cabinets, Switch-side Padlock device according UL 508A		79
Door clutch with Single hole mounting 22 mm, centering aid for plug-in door clutches		80
Padlock device		82
Switch Size		84
Technical Data		86
International Standards and Approvals		204

MAIN, SAFETY AND MAINTENANCE SWITCH

Four hole panel mounting ▶ 2- and 3-pole, IP 66



2-/3-pole



Similar image



Thermal current (I_u/I_{th})	Rating AC-23B (A)	Face plate	Order number
2-pole			
230 V			
20 A	1,5 kW	48 x 48	KG10A.T202/01.E
		64 x 64	KG10B.T202/01.E
3-pole			
3 x 400 V			
20 A	5,5 kW	48 x 48	KG10A.T203/01.E
		64 x 64	KG10B.T203/01.E
25 A	7,5 kW	48 x 48	KG20A.T203/01.E
		64 x 64	KG20B.T203/01.E
32 A	11 kW	48 x 48	KG32A.T203/01.E
		64 x 64	KG32B.T203/01.E
40 A	15 kW	48 x 48	KG41.T203/01.E
		64 x 64	KG41B.T203/01.E
63 A	22 kW	48 x 48	KG64.T203/01.E
		64 x 64	KG64B.T203/01.E
80 A	30 kW	64 x 64	KG80.T203/01.E
		88 x 88	KG80C.T203/01.E
100 A	37 kW	64 x 64	KG100.T203/01.E
		88 x 88	KG100C.T203/01.E
125 A	45 kW	88 x 88	KG125.T203/01.E
160 A	55 kW	88 x 88	KG160.T203/01.E

Complete items



Thermal current (I_u/I_{th})	Rating AC-23B (A)	Face plate	Order number
2-pole			
230 V			
20 A	1,5 kW	48 x 48	KG10A.T102/01.E
		64 x 64	KG10B.T102/01.E
3-pole			
3 x 400 V			
20 A	5,5 kW	48 x 48	KG10A.T103/01.E
		64 x 64	KG10B.T103/01.E
25 A	7,5 kW	48 x 48	KG20A.T103/01.E
		64 x 64	KG20B.T103/01.E
32 A	11 kW	48 x 48	KG32A.T103/01.E
		64 x 64	KG32B.T103/01.E
40 A	15 kW	48 x 48	KG41.T103/01.E
		64 x 64	KG41B.T103/01.E
63 A	22 kW	48 x 48	KG64.T103/01.E
		64 x 64	KG64B.T103/01.E
80 A	30 kW	64 x 64	KG80.T103/01.E
		88 x 88	KG80C.T103/01.E
100 A	37 kW	64 x 64	KG100.T103/01.E
		88 x 88	KG100C.T103/01.E
125 A	45 kW	88 x 88	KG125.T103/01.E
160 A	55 kW	88 x 88	KG160.T103/01.E

2-pole



3-pole



4-hole (standard)

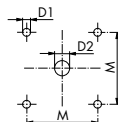

2-hole (alternative)
possible if dimensions "N",
"P" and "D3" are specified

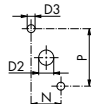

KG10A-KG64B

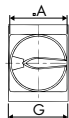
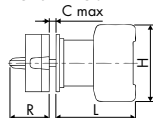

KG80-KG315

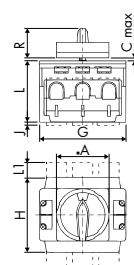

Maximum number of padlocks		
Face plate	Shackle-Ø	Number of padlocks
48 x 48	4	2
	8	1
64 x 64	9	3
88 x 88	10	3

	Switch								Drill hole pattern					
	A	C	G	H	J	L	LI	R	M	N	P	D1	D2	D3
KG10A 2-pole	48	4	48	50		38,7		33	36			5	11-15	
KG10A 3-pole	48	4	48	50		48,2		33	36			5	11-15	
KG10B 2-pole	64	4	48	50		45,7		40,1	48	12,2	30	5	11-15	3,5
KG10B 3-pole	64	4	48	50		55,2		40,1	48	12,2	30	5	11-15	3,5
KG20A, KG32A	48	4	42	54		53,8		33	36			5	10-15	
KG20B, KG32B	64	4	42	54		53,8		40,1	48	12,2	30	5	10-15	3,5
KG41, KG64	48	4	50	64		60,5		33	36			5	10-15	
KG41B	64	4	50	64		60,5		40,1	48	12,2	30	5	10-15	3,5
KG64B	64	4	50	64		60,5		40,1	48	14	37	5	10-15	4,5
KG80, KG100	64	4	70	80	5,5	70,6	26	40,1	48	14	37	5	10-15	4,5
KG80C, KG100C	88	4	70	80	5,5	70,6	26	49,3	68	14	37	6	10-15	4,5
KG125, KG160	88	5,5	112	108		96	22,2	49,3	68			6	13-17	

Information about KG switches with bold terminals please see page 75.



Four hole panel mounting ▶ 2- and 3-pole, IP 66



Similar image



2-pole



3-pole

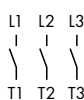

4-hole (standard)

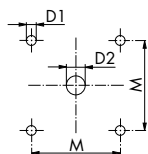

2-hole (alternative)
possible if dimensions "N",
"P" and "D3" are specified

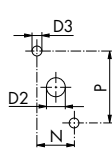

KG10A-KG64B

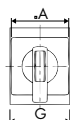
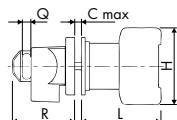

KG80-KG315

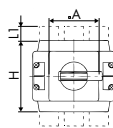
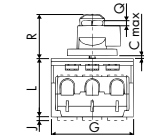

C316

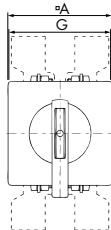
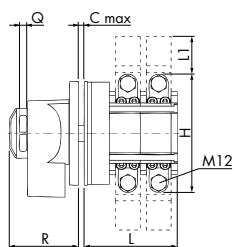

Maximum number of padlocks		
Face plate	Shackle-Ø	Number of padlocks
48 x 48	7	3
	5	4
64 x 64	8	3
	5	4
88 x 88	9	4
130 x 130	9	4

Thermal current (I_u/I_m)	Rating AC-23B (A)	Face plate	Order number
2-pole 230 V			
20 A	1,5 kW	48 x 48	KG10A.T202/04.E
		64 x 64	KG10B.T202/04.E
3-pole 3 x 400 V			
20 A	5,5 kW	48 x 48	KG10A.T203/04.E
		64 x 64	KG10B.T203/04.E
25 A	7,5 kW	48 x 48	KG20A.T203/04.E
		64 x 64	KG20B.T203/04.E
32 A	11 kW	48 x 48	KG32A.T203/04.E
		64 x 64	KG32B.T203/04.E
40 A	15 kW	48 x 48	KG41.T203/04.E
		64 x 64	KG41B.T203/04.E
63 A	22 kW	48 x 48	KG64.T203/04.E
		64 x 64	KG64B.T203/04.E
80 A	30 kW	64 x 64	KG80.T203/04.E
		88 x 88	KG80C.T203/04.E
100 A	37 kW	64 x 64	KG100.T203/04.E
		88 x 88	KG100C.T203/04.E
125 A	45 kW	88 x 88	KG125.T203/04.E
160 A	55 kW	88 x 88	KG160.T203/04.E
200 A	75 kW	88 x 88	KG210.T203/05.E
250 A	90 kW	88 x 88	KG250.T203/05.E
315 A	110 kW	88 x 88	KG315.T203/05.E
315 A	132 kW	130 x 130	C316.T203/05.E ¹

Thermal current (I_u/I_m)	Rating AC-23B (A)	Face plate	Order number
2-pole 230 V			
20 A	1,5 kW	48 x 48	KG10A.T102/04.E
		64 x 64	KG10B.T102/04.E
3-pole 3 x 400 V			
20 A	5,5 kW	48 x 48	KG10A.T103/04.E
		64 x 64	KG10B.T103/04.E
25 A	7,5 kW	48 x 48	KG20A.T103/04.E
		64 x 64	KG20B.T103/04.E
32 A	11 kW	48 x 48	KG32A.T103/04.E
		64 x 64	KG32B.T103/04.E
40 A	15 kW	48 x 48	KG41.T103/04.E
		64 x 64	KG41B.T103/04.E
63 A	22 kW	48 x 48	KG64.T103/04.E
		64 x 64	KG64B.T103/04.E
80 A	30 kW	64 x 64	KG80.T103/04.E
		88 x 88	KG80C.T103/04.E
100 A	37 kW	64 x 64	KG100.T103/04.E
		88 x 88	KG100C.T103/04.E
125 A	45 kW	88 x 88	KG125.T103/04.E
160 A	55 kW	88 x 88	KG160.T103/04.E
200 A	75 kW	88 x 88	KG210.T103/05.E
250 A	90 kW	88 x 88	KG250.T103/05.E
315 A	110 kW	88 x 88	KG315.T103/05.E
315 A	132 kW	130 x 130	C316.T103/05.E ¹

	Switch							Drill hole pattern							
	A	C	G	H	J	L	L1	Q	R	M	N	P	D1	D2	D3
KG10A 2-pole	48	4	48	50		38,7		7,2	51	36	12,2	30	5	11-15	3,5
KG10A 3-pole	48	4	48	50		48,2		7,2	51	36	12,2	30	5	11-15	3,5
KG10B 2-pole	64	4	48	50		45,7		8,1	58	48			5	11-15	
KG10B 3-pole	64	4	48	50		55,2		8,1	58	48			5	11-15	
KG20A, KG32A	48	4	42	54		53,8		7,2	51	36	12,2	30	5	10-15	3,5
KG20B, KG32B	64	4	42	54		53,8		8,1	58	48			5	10-15	
KG41, KG64	48	4	50	64		60,5		7,2	51	36			5	10-15	
KG41B	64	4	50	64		60,5		8,1	58	48			5	10-15	
KG64B	64	4	50	64		60,5		8,1	58	48	14	37	5	10-15	4,5
KG80, KG100	64	4	70	80	5,5	70,6	26	8,1	58	48	14	37	5	10-15	4,5
KG80C, KG100C	88	4	70	80	5,5	70,6	26	9	73	68			6	10-15	
KG125, KG160	88	5,5	112	108		96	22,2	9	73	68			6	13-17	
KG210, KG250	88	5,5	145	126	6	103	25	9	73	68			6	13-17	
KG315	88	5,5	145	126	6	103	25	9	73	68			6	13-17	
C316	130	7	128	150		117,2	46	9	86,5	104			7	16-20	

¹ Protection IP 40, enhanced protection degree On request

Information about KG switches with bold terminals please see page 75.

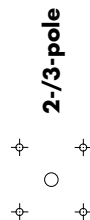

Complete items

MAIN, SAFETY AND MAINTENANCE SWITCH

Four hole panel mounting ▶ 3 pole + 1 NO, IP 66



3-pole + 1NO



Similar image



Thermal current (Iu/Ith)	Rating AC-23B (A)	Face plate	Order number
3-pole + 1NO 3 x 400 V			
20 A	5,5 kW	48 x 48 64 x 64	KG10A.T203/17.E KG10B.T203/17.E
25 A	7,5 kW	48 x 48 64 x 64	KG20A.T203/17.E KG20B.T203/17.E
32 A	11 kW	48 x 48 64 x 64	KG32A.T203/17.E KG32B.T203/17.E
40 A	15 kW	64 x 64	KG41B.T203/17.E
63 A	22 kW	64 x 64	KG64B.T203/17.E
80 A	30 kW	64 x 64 88 x 88	KG80.T203/17.E KG80C.T203/17.E
100 A	37 kW	64 x 64 88 x 88	KG100.T203/17.E KG100C.T203/17.E
125 A	45 kW	88 x 88	KG125.T203/17.E
160 A	55 kW	88 x 88	KG160.T203/17.E

Thermal current (Iu/Ith)	Rating AC-23B (A)	Face plate	Order number
3-pole + 1NO 3 x 400 V			
20 A	5,5 kW	48 x 48 64 x 64	KG10A.T103/17.E KG10B.T103/17.E
25 A	7,5 kW	48 x 48 64 x 64	KG20A.T103/17.E KG20B.T103/17.E
32 A	11 kW	48 x 48 64 x 64	KG32A.T103/17.E KG32B.T103/17.E
40 A	15 kW	64 x 64	KG41B.T103/17.E
63 A	22 kW	64 x 64	KG64B.T103/17.E
80 A	30 kW	64 x 64 88 x 88	KG80.T103/17.E KG80C.T103/17.E
100 A	37 kW	64 x 64 88 x 88	KG100.T103/17.E KG100C.T103/17.E
125 A	45 kW	88 x 88	KG125.T103/17.E
160 A	55 kW	88 x 88	KG160.T103/17.E

Complete items



Maximum number of padlocks		
Face plate	Shackle-Ø	Number of padlocks
48 x 48	4	2
48 x 48	8	1
64 x 64	9	3
88 x 88	10	3

4-hole (standard)

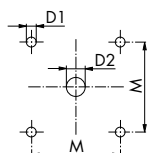

2-hole (alternative)
possible if dimensions "N",
"P" and "D3" are specified

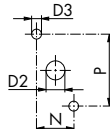

KG10A-KG64B

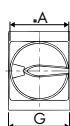
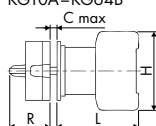

KG80-KG160

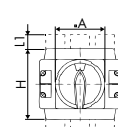
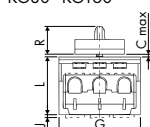

	Drill hole pattern					
	M	N	P	D1	D2	D3
KG10A	36			5	11-15	
KG10B	48	12,2	30	5	11-15	3,5
KG20A, KG32A	36			5	10-15	
KG20B, KG32B	48	12,2	30	5	10-15	3,5
KG41B	48	12,2	30	5	10-15	3,5
KG64B	48	14	37	5	10-15	4,5
KG80, KG100	48	14	37	5	10-15	4,5
KG80C, KG100C	68	14	37	6	10-15	4,5
KG125, KG160	68			6	13-17	

	Switch							
	A	C	G	H	J	L	L1	R
KG10A	48	4	48	50		48,2		33
KG10B	64	4	48	50		55,2		40,1
KG20A, KG32A	48	4	42	54		62,8		33
KG20B, KG32B	64	4	42	54		62,8		40,1
KG41B, KG64B	64	4	50	64		70,5		40,1
KG80, KG100	64	4	70	80	5,5	80,6	26	40,1
KG80C, KG100C	88	4	70	80	5,5	80,6	26	49,3
KG125, KG160	88	5,5	112	108		117	22,2	49,3

Information about KG switches with bold terminals please see page 75.



Four hole panel mounting ▶ 3 pole + 1 NO, IP 66



Similar image



Thermal current (Iu/Ith)	Rating AC-23B (A)	Face plate	Order number
3-pole + 1NO 3 x 400 V			
20 A	5,5 kW	48 x 48 64 x 64	KG10A.T203/20.E KG10B.T203/20.E
25 A	7,5 kW	48 x 48 64 x 64	KG20A.T203/20.E KG20B.T203/20.E
32 A	11 kW	48 x 48 64 x 64	KG32A.T203/20.E KG32B.T203/20.E
40 A	15 kW	64 x 64	KG41B.T203/20.E
63 A	22 kW	64 x 64	KG64B.T203/20.E
80 A	30 kW	64 x 64 88 x 88	KG80.T203/20.E KG80C.T203/20.E
100 A	37 kW	64 x 64 88 x 88	KG100.T203/20.E KG100C.T203/20.E
125 A	45 kW	88 x 88	KG125.T203/20.E
160 A	55 kW	88 x 88	KG160.T203/20.E
200 A	75 kW	88 x 88	KG210.T203/21.E
250 A	90 kW	88 x 88	KG250.T203/21.E
315 A	110 kW	88 x 88	KG315.T203/21.E
315 A	132 kW	130 x 130	C316.T203/21.E¹

KG

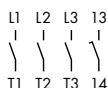

C316



4-hole (standard)

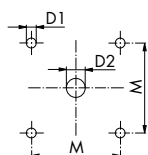

2-hole (alternative)
possible if dimensions "N",
"P" and "D3" are specified

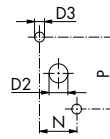

KG10A-KG64B

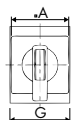
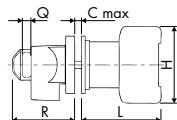

KG80-KG315

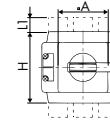
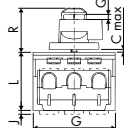

C316

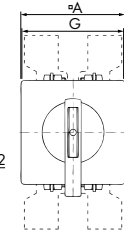
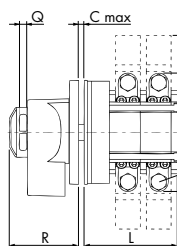

Maximum number of padlocks		
Face plate	Shackle-∅	Number of padlocks
48 x 48	7	3
	5	4
64 x 64	8	3
	5	4
88 x 88	9	4
130 x 130	9	4

Thermal current (Iu/Ith)	Rating AC-23B (A)	Face plate	Order number
3-pole + 1NO 3 x 400 V			
20 A	5,5 kW	48 x 48 64 x 64	KG10A.T103/20.E KG10B.T103/20.E
25 A	7,5 kW	48 x 48 64 x 64	KG20A.T103/20.E KG20B.T103/20.E
32 A	11 kW	48 x 48 64 x 64	KG32A.T103/20.E KG32B.T103/20.E
40 A	15 kW	64 x 64	KG41B.T103/20.E
63 A	22 kW	64 x 64	KG64B.T103/20.E
80 A	30 kW	64 x 64 88 x 88	KG80.T103/20.E KG80C.T103/20.E
100 A	37 kW	64 x 64 88 x 88	KG100.T103/20.E KG100C.T103/20.E
125 A	45 kW	88 x 88	KG125.T103/20.E
160 A	55 kW	88 x 88	KG160.T103/20.E
200 A	75 kW	88 x 88	KG210.T103/21.E
250 A	90 kW	88 x 88	KG250.T103/21.E
315 A	110 kW	88 x 88	KG315.T103/21.E
315 A	132 kW	130 x 130	C316.T103/21.E¹

	Drill hole pattern					
	M	N	P	D1	D2	D3
KG10A	36	12,2	30	5	11-15	3,5
KG10B	48			5	11-15	
KG20A, KG32A	36	12,2	30	5	10-15	3,5
KG20B, KG32B	48			5	10-15	
KG41B	48	12,2	30	5	10-15	3,5
KG64B	48	14	37	5	10-15	4,5
KG80, KG100	48	14	37	5	10-15	4,5
KG80C, KG100C	68			6	10-15	
KG125, KG160	68			6	13-17	
KG210, KG250	68			6	13-17	
KG315	68			6	13-17	
C316	104			7	16-20	

	Switch								
	A	C	G	H	J	L	L1	R	Q
KG10A	48	4	48	50		48,2	26	51	7,2
KG10B	64	4	48	50		55,2		58	8
KG20A, KG32A	48	4	42	54		62,8		51	7,2
KG20B, KG32B	64	4	42	54		62,8		58	8
KG41B, KG64B	64	4	50	64		70,5		58	8
KG80, KG100	64	4	70	80	5,5	80,6	26	58	8
KG80C, KG100C	88	4	70	80	5,5	80,6	26	73	9
KG125, KG160	88	5,5	112	108		117	22,2	73	9
KG210, KG250	88	5,5	145	126	6	124	25	73	9
KG315	88	5,5	145	126	6	124	25	73	9
C316	130	7	128	150		134,2	46	86,5	9,2

¹ Protection IP 40, enhanced protection degree On request

Information about KG switches with bold terminals please see page 75.



3-pole + 1NO

Complete items

MAIN, SAFETY AND MAINTENANCE SWITCH

Four hole panel mounting ▶ 3 pole + 1 NO + 1 NC, IP 66



3-pole +
1NO + 1 NC



Similar image



Thermal current (I_u/I_{th})	Rating AC-23B (A)	Face plate	Order number
3-pole + 1NO + 1NC	3 x 380 V/440 V		
20 A	5,5 kW	64 x 64	KG10B.T203/A1.E
25 A	7,5 kW	64 x 64	KG20B.T203/A1.E
32 A	11 kW	64 x 64	KG32B.T203/A1.E
40 A	15 kW	64 x 64	KG41B.T203/A1.E
63 A	22 kW	64 x 64	KG64B.T203/A1.E
80 A	30 kW	64 x 64 88 x 88	KG80.T203/A1.E KG80C.T203/A1.E
100 A	37 kW	64 x 64 88 x 88	KG100.T203/A1.E KG100C.T203/A1.E
125 A	45 kW	88 x 88	KG125.T203/A1.E
160 A	55 kW	88 x 88	KG160.T203/A1.E

Thermal current (I_u/I_{th})	Rating AC-23B (A)	Face plate	Order number
3-pole + 1NO + 1NC	3 x 380 V/440 V		
20 A	5,5 kW	64 x 64	KG10B.T103/A1.E
25 A	7,5 kW	64 x 64	KG20B.T103/A1.E
32 A	11 kW	64 x 64	KG32B.T103/A1.E
40 A	15 kW	64 x 64	KG41B.T103/A1.E
63 A	22 kW	64 x 64	KG64B.T103/A1.E
80 A	30 kW	64 x 64 88 x 88	KG80.T103/A1.E KG80C.T103/A1.E
100 A	37 kW	64 x 64 88 x 88	KG100.T103/A1.E KG100C.T103/A1.E
125 A	45 kW	88 x 88	KG125.T103/A1.E
160 A	55 kW	88 x 88	KG160.T103/A1.E

Maximum number of padlocks		
Face plate	Shackle-Ø	Number of padlocks
64 x 64	9	3
88 x 88	10	3

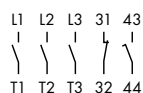

4-hole (standard)

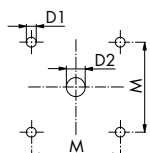

2-hole (alternative)
possible if dimensions "N",
"P" and "D3" are specified

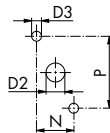

KG10A-KG64B

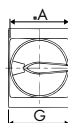
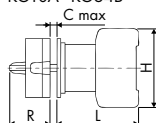

KG80-KG160

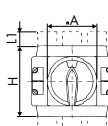
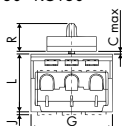

	Drill hole pattern					
	M	N	P	D1	D2	D3
KG10B	48	12,2	30	5	11-15	3,5
KG20B, KG32B	48	12,2	30	5	10	3,5
KG41B	48	12,2	30	5	10	3,5
KG64B	48	14	37	5	10	3,5
KG80, KG100	48	14	37	5	10	4,5
KG80C, KG100C	68	14	37	6	10	4,5
KG125, KG160	68			6	13	

	Switch							
	A	C	G	H	J	L	L1	R
KG10B	64	4	48	50		55,2		40,1
KG20B, KG32B	64	4	42	54		53,8		40,1
KG41B, KG64B	64	4	50	64		60,5		40,1
KG80, KG100	64	4	70	80	5,5	70,6	26	40,1
KG80C, KG100C	88	4	70	80	5,5	70,6	26	49,3
KG125, KG160	88	5,5	112	108		96	22,2	49,3

Information about KG switches with bold terminals please see page 75.

Complete items



Four hole panel mounting ▶ 3 pole + 1 NO + 1 NC, IP 66



Similar image



KG

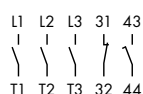

4-hole (standard)

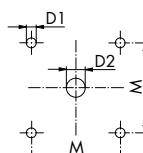

KG10A-KG64B

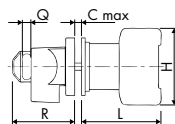

KG80-KG315

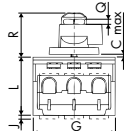

C316

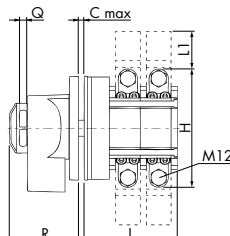

C316

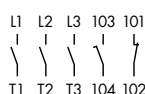

2-hole (alternative)
possible if dimensions "N",
"P" and "D3" are specified

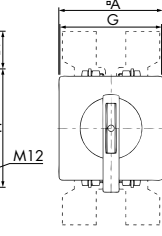
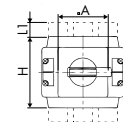
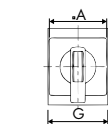
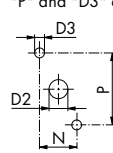

Thermal current (I _n /I _{th})	Rating AC-23B (A)	Face plate	Order number
3-pole + 1NO + 1NC	3 x 380 V/440 V		
20 A	5,5 kW	48 x 48 64 x 64	KG10A.T203/A2.E KG10B.T203/A2.E
25 A	7,5 kW	48 x 48 64 x 64	KG20A.T203/A2.E KG20B.T203/A2.E
32 A	11 kW	48 x 48 64 x 64	KG32A.T203/A2.E KG32B.T203/A2.E
40 A	15 kW	64 x 64	KG41B.T203/A2.E
63 A	22 kW	64 x 64	KG64B.T203/A2.E
80 A	30 kW	64 x 64 88 x 88	KG80.T203/A2.E KG80C.T203/A2.E
100 A	37 kW	64 x 64 88 x 88	KG100.T203/A2.E KG100C.T203/A2.E
125 A	45 kW	88 x 88	KG125.T203/A2.E
160 A	55 kW	88 x 88	KG160.T203/A2.E
200 A	75 kW	88 x 88	KG210.T203/A3.E
250 A	90 kW	88 x 88	KG250.T203/A3.E
315 A	110 kW	88 x 88	KG315.T203/A3.E
315 A	132 kW	130 x 130	C316.T203/A3.E ¹

Thermal current (I _n /I _{th})	Rating AC-23B (A)	Face plate	Order number
3-pole + 1NO + 1NC	3 x 380 V/440 V		
20 A	5,5 kW	48 x 48 64 x 64	KG10A.T103/A2.E KG10B.T103/A2.E
25 A	7,5 kW	48 x 48 64 x 64	KG20A.T103/A2.E KG20B.T103/A2.E
32 A	11 kW	48 x 48 64 x 64	KG32A.T103/A2.E KG32B.T103/A2.E
40 A	15 kW	64 x 64	KG41B.T103/A2.E
63 A	22 kW	64 x 64	KG64B.T103/A2.E
80 A	30 kW	64 x 64 88 x 88	KG80.T103/A2.E KG80C.T103/A2.E
100 A	37 kW	64 x 64 88 x 88	KG100.T103/A2.E KG100C.T103/A2.E
125 A	45 kW	88 x 88	KG125.T103/A2.E
160 A	55 kW	88 x 88	KG160.T103/A2.E
200 A	75 kW	88 x 88	KG210.T103/A3.E
250 A	90 kW	88 x 88	KG250.T103/A3.E
315 A	110 kW	88 x 88	KG315.T103/A3.E
315 A	132 kW	130 x 130	C316.T103/A3.E ¹

¹ C316 Protection IP 44, enhanced protection degree on request

Face plate	Maximum number of padlocks	
	Shackle-Ø	Number of padlocks
48 x 48	7	3
	5	4
64 x 64	8	3
	5	4
88 x 88	9	4
130 x 130	9	4

	Drill hole pattern					
	M	N	P	D1	D2	D3
KG10B	48	12,2	30	5	11-15	3,5
KG20B, KG32B	48	12,2	30	5	10	3,5
KG41B	48	12,2	30	5	10	3,5
KG64B	48	14	37	5	10	4,5
KG80, KG100	48	14	37	5	10	4,5
KG80C, KG100C	68	14	37	6	10	4,5
KG125, KG160	68			6	13	
KG210, KG250, KG315	68			6	13	
C316	104			7	16	

	Switch								
	A	C	G	H	J	L	L1	R	Q
KG10B	64	4	48	50		55,2		58	8
KG20B, KG32B	64	4	42	54		53,8		58	8
KG41B, KG64B	64	4	50	64		60,5		58	8
KG80, KG100	64	4	70	80	5,5	70,6	26	58	8
KG80C, KG100C	88	4	70	80	5,5	70,6	26	73	9
KG125, KG160	88	5,5	112	108		96	22,2	73	9
KG210, KG250, KG315	88	5,5	145	126	6	124	25	73	9
C316	130	7	128	150		134,2	46	86,5	9,2

Information about KG switches with bold terminals please see page 75.

3-pole + 1NO + 1 NC

Complete items

MAIN, SAFETY AND MAINTENANCE SWITCH

Four hole panel mounting ▶ 3-pole + 1 NO H-bridge Gold, IP 66



3-pole + 1NO
H-bridge Gold



Similar image



Thermal current (Iu/Ith)	Rating AC-23B (A)	Face plate	Order number
3-pole			
25 A	7,5 kW	64 x 64	KG20B.T203/D-A130.E
32 A	11 kW	64 x 64	On request
40 A	15 kW	64 x 64	On request
63 A	22 kW	64 x 64	On request
80 A	30 kW	64 x 64	KG80.T203/D-A133.E
		88 x 88	On request
100 A	37 kW	64 x 64	On request
		88 x 88	On request
125 A	45 kW	88 x 88	On request
160 A	55 kW	88 x 88	On request

Thermal current (Iu/Ith)	Rating AC-23B (A)	Face plate	Order number
3-pole			
25 A	7,5 kW	64 x 64	On request
32 A	11 kW	64 x 64	On request
40 A	15 kW	64 x 64	On request
63 A	22 kW	64 x 64	On request
80 A	30 kW	64 x 64	KG80.T103/D-W020.E
		88 x 88	On request
100 A	37 kW	64 x 64	KG100.T103/D-W020.E
		88 x 88	KG100C.T103/D-A098.E
125 A	45 kW	88 x 88	On request
160 A	55 kW	88 x 88	KG160.T103/D-A076.E

Complete items

KG

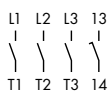

4-hole (standard)

2-hole (alternative)
possible if dimensions "N",
"P" and "D3" are specified

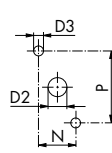
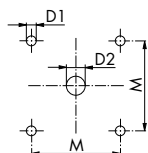

KG20B-KG64B

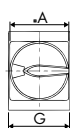
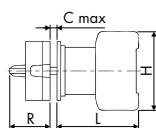

KG80-KG160

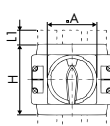
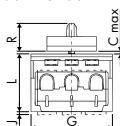

Notice:

Highest contact reliability by H-bridge design with self-cleaning „cross-wire“ contacts. Gold plated for low voltage, low current applications.

Exception: KG20B and KG32B instead H-bridge design equipped with multiple connecting contacts.

Maximum number of padlocks		
Face plate	Shackle-Ø	Number of padlocks
64 x 64	9	3
88 x 88	10	3

	Drill hole pattern					
	M	N	P	D1	D2	D3
KG20B, KG32B	48	12,2	30	5	10-15	3,5
KG41B, KG64B	48	12,2	30	5	10-15	3,5
KG80, KG100	48	14	37	5	10-15	4,5
KG80C, KG100C	48	14	37	5	10-15	4,5
KG125, KG160	68	14	37	6	10-15	4,5
				6	13-17	

	Switch							
	A	C	G	H	J	L	L1	R
KG20B, KG32B	64	4	42	54		62,8		40,1
KG41B, KG64B	64	4	50	64		70,5		40,1
KG80, KG100	64	4	70	80	5,5	80,6	26	40,1
KG80C, KG100C	88	4	70	80	5,5	80,6	26	49,3
KG125, KG160	88	5,5	112	108		117	22,2	49,3

Information about KG switches with bold terminals please see page 75.



Four hole panel mounting ▶ 3-pole + 1 NO H-bridge Gold, IP 66



Similar image



KG

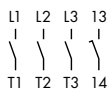

C316



4-hole (standard)

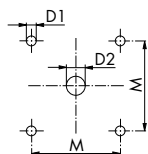

2-hole (alternative)
possible if dimensions "N",
"P" and "D3" are specified

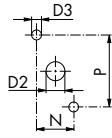

KG20B-KG64B

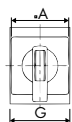
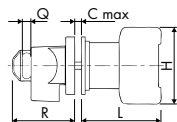

KG80-KG315

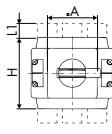
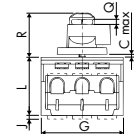

C316

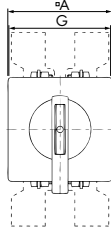
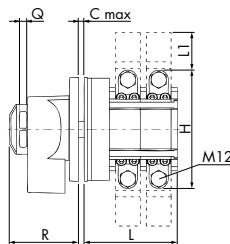

Maximum number of padlocks		
Face plate	Shackle-∅	Number of padlocks
48 x 48	7	3
	5	4
64 x 64	8	3
	5	4
88 x 88	9	4
130 x 130	9	4

Thermal current (Iu/Ith)	Rating AC-23B (A)	Face plate	Order number
3-pole			
25 A	7,5 kW	64 x 64	KG20B.T203/D-A288.E
32 A	11 kW	64 x 64	KG32B.T203/D-A190.E
40 A	15 kW	64 x 64	KG41B.T203/D-A076.E
63 A	22 kW	64 x 64	KG64B.T203/D-A044.E
80 A	30 kW	64 x 64	KG80.T203/D-A025.E
		88 x 88	KG80C.T203/D-A026.E
100 A	37 kW	64 x 64	KG100.T203/D-A020.E
		88 x 88	KG100C.T203/D-A021.E
125 A	45 kW	88 x 88	KG125.T203/D-A016.E
160 A	55 kW	88 x 88	KG160.T203/D-A014.E
200 A	75 kW	88 x 88	KG210.T203/D-A002.E
250 A	90 kW	88 x 88	KG250.T203/D-A006.E
315 A	110 kW	88 x 88	KG315.T203/D-A003.E
315 A	132 kW	130 x 130	C316.T203/D-A008.E ¹

Thermal current (Iu/Ith)	Rating AC-23B (A)	Face plate	Order number
3-pole			
25 A	7,5 kW	64 x 64	KG20B.T103/D-A070.E
32 A	11 kW	64 x 64	KG32B.T103/D-A124.E
40 A	15 kW	64 x 64	KG41B.T103/D-A037.E
63 A	22 kW	64 x 64	KG64B.T103/D-A026.E
80 A	30 kW	64 x 64	KG80.T103/D-A017.E
		88 x 88	KG80C.T103/D-A018.E
100 A	37 kW	64 x 64	KG100.T103/D-A012.E
		88 x 88	KG100C.T103/D-A013.E
125 A	45 kW	88 x 88	KG125.T103/D-A010.E
160 A	55 kW	88 x 88	KG160.T103/D-A010.E
200 A	75 kW	88 x 88	KG210.T103/D-A001.E
250 A	90 kW	88 x 88	KG250.T103/D-A012.E
315 A	110 kW	88 x 88	KG315.T103/D-A008.E
315 A	132 kW	130 x 130	C316.T103/D-A010.E ¹

Notice:

Highest contact reliability by H-bridge design with self-cleaning „cross-wire“ contacts. Gold plated for low voltage, low current applications.

Exception: KG20B and KG32B instead H-bridge design equipped with multiple connecting contacts, C316 instead H-bridge Gold design equipped with connecting contacts.

	Drill hole pattern					
	M	N	P	D1	D2	D3
KG20B, KG32B	48			5	10-15	
KG41B	48	12,2	30	5	10-15	3,5
KG64B	48	14	37	5	10-15	4,5
KG80, KG100	48	14	37	5	10-15	4,5
KG80C, KG100C	68			6	10-15	
KG125, KG160	68			6	13-17	
KG210, KG250	68			6	13-17	
KG315	68			6	13-17	
C316	104			7	16-20	

	Switch								
	A	C	G	H	J	L	LI	R	Q
KG20B, KG32B	64	4	42	54		62,8		58	8
KG41B, KG64B	64	4	50	64		70,5		58	8
KG80, KG100	64	4	70	80	5,5	80,6	26	58	8
KG80C, KG100C	88	4	70	80	5,5	80,6	26	73	9
KG125, KG160	88	5,5	112	108		117	22,2	73	9
KG210, KG250	88	5,5	145	126	6	124	25	73	9
KG315	88	5,5	145	126	6	124	25	73	9
C316	130	7	128	150		134,2	46	86,5	9,2

¹ Protection IP 40, enhanced protection degree on request

Information about KG switches with bold terminals please see page 75.

3-pole + 1NO
H-bridge Gold

Complete items

MAIN, SAFETY AND MAINTENANCE SWITCH

Four hole panel mounting ▶ 3-pole + N + PE, IP 66



3-pole +
N + PE



Similar image



Thermal current (Iu/Ith)	Rating AC-23B (A)	Face plate	Order number
3-pole+N+PE 3 x 400 V			
25 A	7,5 kW	48 x 48 64 x 64	KG20A.T205/01.E KG20B.T205/01.E
32 A	11 kW	48 x 48 64 x 64	KG32A.T205/01.E KG32B.T205/01.E
40 A	15 kW	48 x 48 64 x 64	auf Anfrage KG41B.T205/01.E
63 A	22 kW	48 x 48 64 x 64	auf Anfrage KG64B.T205/01.E
80 A	30 kW	64 x 64 88 x 88	KG80.T205/01.E KG80C.T205/01.E
100 A	37 kW	64 x 64 88 x 88	KG100.T205/01.E KG100C.T205/01.E
125 A	45 kW	88 x 88	KG125.T205/01.E
160 A	55 kW	88 x 88	KG160.T205/01.E

Thermal current (Iu/Ith)	Rating AC-23B (A)	Face plate	Order number
3-pole+N+PE 3 x 400 V			
25 A	7,5 kW	48 x 48 64 x 64	KG20A.T105/01.E KG20B.T105/01.E
32 A	11 kW	48 x 48 64 x 64	KG32A.T105/01.E KG32B.T105/01.E
40 A	15 kW	48 x 48 64 x 64	auf Anfrage KG41B.T105/01.E
63 A	22 kW	48 x 48 64 x 64	auf Anfrage KG64B.T105/01.E
80 A	30 kW	64 x 64 88 x 88	KG80.T105/01.E KG80C.T105/01.E
100 A	37 kW	64 x 64 88 x 88	KG100.T105/01.E KG100C.T105/01.E
125 A	45 kW	88 x 88	KG125.T105/01.E
160 A	55 kW	88 x 88	KG160.T105/01.E

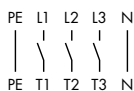

2-hole (alternative)
possible if dimensions "N",
"P" and "D3" are specified

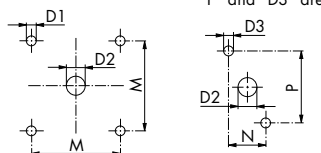

KG20A-KG64B

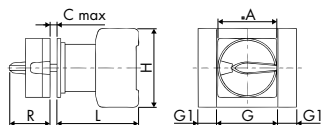

KG80-KG160

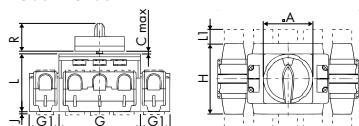

Maximum number of padlocks		
Face plate	Shackle-Ø	Number of padlocks
48 x 48	4	2
	8	1
64 x 64	9	3
88 x 88	10	3

	Drill hole pattern					
	M	N	P	D1	D2	D3
KG20A, KG32A	36			5	10-15	
KG20B, KG32B	48	12,2	30	5	10-15	3,5
KG41, KG64	36			5	10-15	
KG41B	48	12,2	30	5	10-15	3,5
KG64B	48	14	37	5	10-15	4,5
KG80, KG100	48	14	37	5	10-15	4,5
KG80C, KG100C	68	14	37	6	10-15	4,5
KG125, KG160	68			6	13-17	

	Switch								
	A	C	G	G1	H	J	L	L1	R
KG20A, KG32A	48	4	42	13,5	54		53,8		33
KG20B, KG32B	64	4	42	13,5	54		53,8		40,1
KG41, KG64	48	4	50	16	64		60,5		33
KG41B, KG64B	64	4	50	16	64		60,5		40,1
KG80, KG100	64	4	70	22	80	5,5	70,6	26	40,1
KG80C, KG100C	88	4	70	22	80	5,5	70,6	26	49,3
KG125, KG160	88	5,5	112	38	108		96	22,2	49,3

Information about KG switches with bold terminals please see page 75.



Four hole panel mounting ▶ 3-pole + N + PE, IP 66



Similar image



Thermal current (Iu/Ith)	Rating AC-23B (A)	Face plate	Order number
3-pole + N + PE 3 x 400 V			
25 A	7,5 kW	48 x 48 64 x 64	KG20A.T205/04.E KG20B.T205/04.E
32 A	11 kW	48 x 48 64 x 64	KG32A.T205/04.E KG32B.T205/04.E
40 A	15 kW	48 x 48 64 x 64	KG41.T205/04.E KG41B.T205/04.E
63 A	22 kW	48 x 48 64 x 64	KG64.T205/04.E KG64B.T205/04.E
80 A	30 kW	64 x 64 88 x 88	KG80.T205/04.E KG80C.T205/04.E
100 A	37 kW	64 x 64 88 x 88	KG100.T205/04.E KG100C.T205/04.E
125 A	45 kW	88 x 88	KG125.T205/04.E
160 A	55 kW	88 x 88	KG160.T205/04.E
200 A	75 kW	88 x 88	KG210.T205/05.E
250 A	90 kW	88 x 88	KG250.T205/05.E
315 A	110 kW	88 x 88	KG315.T205/05.E



Thermal current (Iu/Ith)	Rating AC-23B (A)	Face plate	Order number
3-pole + N + PE 3 x 400 V			
25 A	7,5 kW	48 x 48 64 x 64	KG20A.T105/04.E KG20B.T105/04.E
32 A	11 kW	48 x 48 64 x 64	KG32A.T105/04.E KG32B.T105/04.E
40 A	15 kW	48 x 48 64 x 64	KG41.T105/04.E KG41B.T105/04.E
63 A	22 kW	48 x 48 64 x 64	KG64.T105/04.E KG64B.T105/04.E
80 A	30 kW	64 x 64 88 x 88	KG80.T105/04.E KG80C.T105/04.E
100 A	37 kW	64 x 64 88 x 88	KG100.T105/04.E KG100C.T105/04.E
125 A	45 kW	88 x 88	KG125.T105/04.E
160 A	55 kW	88 x 88	KG160.T105/04.E
200 A	75 kW	88 x 88	KG210.T105/05.E
250 A	90 kW	88 x 88	KG250.T105/05.E
315 A	110 kW	88 x 88	KG315.T105/05.E

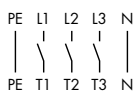

4-hole (standard)

2-hole (alternative) possible if dimensions "N", "P" and "D3" are specified

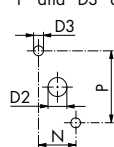
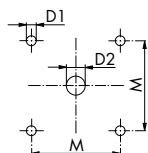

KG20A-KG64B

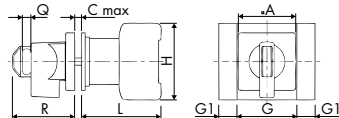

KG80-KG315

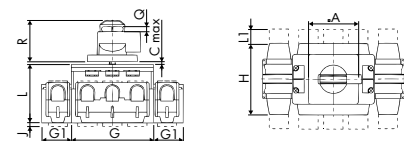

Maximum number of padlocks		
Face plate	Shackle-Ø	Number of padlocks
48 x 48	7	3
	5	4
64 x 64	8	3
	5	4
88 x 88	9	4
130 x 130	9	4

	Drill hole pattern					
	M	N	P	D1	D2	D3
KG20A, KG32A	36	12,2	30	5	10-15	3,5
KG20B, KG32B	48			5	10-15	
KG41, KG64	36			5	10-15	
KG41B	48			5	10-15	
KG64B	48	14	37	5	10-15	4,5
KG80, KG100	48	14	37	5	10-15	4,5
KG80C, KG100C	68			6	10-15	
KG125, KG160	68			6	13-17	
KG210, KG250	68			6	13-17	
KG315	68			6	13-17	

	Switch									
	A	C	G	G1	H	J	L	LI	R	Q
KG20A, KG32A	48	4	42	13,5	54		53,8		51	7,2
KG20B, KG32B	64	4	42	13,5	54		53,8		58	8
KG41, KG64	48	4	50	16	64		60,5		51	7,2
KG41B, KG64B	64	4	50	16	64		60,5		58	8
KG80, KG100	64	4	70	22	80	5,5	70,6	26	58	8
KG80C, KG100C	88	4	70	22	80	5,5	70,6	26	73	9
KG125, KG160	88	5,5	112	38	108		96	22,2	73	9
KG210, KG250	88	5,5	145	126	6	124	25	73	9	
KG315	88	5,5	145	126	6	124	25	73	9	

Information about KG switches with bold terminals please see page 75.



3-pole + N + PE



Complete items

MAIN, SAFETY AND MAINTENANCE SWITCH

Four hole panel mounting ▶ 4-pole, IP 66



4-pole

Similar image



Complete items



Thermal current (Iu/Ith)	Rating AC-23B (A)	Face plate	Order number
4-pole			
3 x 400 V			
20 A	5,5 kW	48 x 48	KG10A.T204/01.E
		64 x 64	KG10B.T204/01.E
25 A	7,5 kW	48 x 48	KG20A.T204/01.E
		64 x 64	KG20B.T204/01.E
32 A	11 kW	48 x 48	KG32A.T204/01.E
		64 x 64	KG32B.T204/01.E
40 A	15 kW	48 x 48	KG41.T204/01.E
		64 x 64	KG41B.T204/01.E
63 A	22 kW	48 x 48	KG64.T204/01.E
		64 x 64	KG64B.T204/01.E
80 A	30 kW	64 x 64	KG80.T204/01.E
		88 x 88	KG80C.T204/01.E
100 A	37 kW	64 x 64	KG100.T204/01.E
		88 x 88	KG100C.T204/01.E
125 A	45 kW	88 x 88	KG125.T204/01.E
160 A	55 kW	88 x 88	KG160.T204/01.E

Thermal current (Iu/Ith)	Rating AC-23B (A)	Face plate	Order number
4-pole			
3 x 400 V			
20 A	5,5 kW	48 x 48	KG10A.T104/01.E
		64 x 64	KG10B.T104/01.E
25 A	7,5 kW	48 x 48	KG20A.T104/01.E
		64 x 64	KG20B.T104/01.E
32 A	11 kW	48 x 48	KG32A.T104/01.E
		64 x 64	KG32B.T104/01.E
40 A	15 kW	48 x 48	KG41.T104/01.E
		64 x 64	KG41B.T104/01.E
63 A	22 kW	48 x 48	KG64.T104/01.E
		64 x 64	KG64B.T104/01.E
80 A	30 kW	64 x 64	KG80.T104/01.E
		88 x 88	KG80C.T104/01.E
100 A	37 kW	64 x 64	KG100.T104/01.E
		88 x 88	KG100C.T104/01.E
125 A	45 kW	88 x 88	KG125.T104/01.E
160 A	55 kW	88 x 88	KG160.T104/01.E



4-hole (standard)

2-hole (alternative)
possible if dimensions "N",
"P" and "D3" are specified

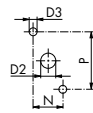
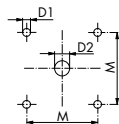

KG10A-KG64B

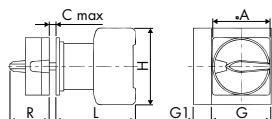

KG80-KG315

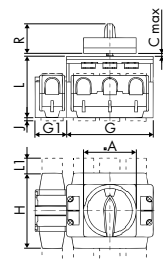

Face plate	Shackle-Ø	Number of padlocks
48 x 48	4	2
64 x 64	8	1
64 x 64	9	3
88 x 88	10	3

	Switch										Drill hole pattern				
	A	C	G	G1	H	J	L	L1	R	M	N	P	D1	D2	D3
KG10A	48	4	48	0	50		48,2	33	36				5	11-15	
KG10B	64	4	48	0	50		55,2	40,1	48	12,2	30		5	11-15	3,5
KG20A, KG32A	48	4	42	13,5	54		53,8	33	36				5	10-15	
KG20B, KG32B	64	4	42	13,5	54		53,8	40,1	48	12,2	30		5	10-15	3,5
KG41, KG64	48	4	50	16	64		60,5	33	36				5	10-15	
KG41B	64	4	50	16	64		60,5	40,1	48	12,2	30		5	10-15	3,5
KG64B	64	4	50	16	64		60,5	40,1	48	14	37		5	10-15	4,5
KG80, KG100	64	4	70	22	80	5,5	70,6	26	40,1	48	14	37	5	10-15	4,5
KG80C, KG100C	88	4	70	22	80	5,5	70,6	26	49,3	68	14	37	6	10-15	4,5
KG125, KG160	88	5,5	112	38	108		96	22,2	49,3	68			6	13-17	

Information about KG switches with bold terminals please see page 75.



Four hole panel mounting ▶ 4-pole, IP 66



Similar image



Thermal current (Iu/Ith)	Rating AC-23B (A)	Face plate	Order number
4-pole			
3 x 400 V			
20 A	5,5 kW	48 x 48	KG10A.T204/04.E
		64 x 64	KG10B.T204/04.E
25 A	7,5 kW	48 x 48	KG20A.T204/04.E
		64 x 64	KG20B.T204/04.E
32 A	11 kW	48 x 48	KG32A.T204/04.E
		64 x 64	KG32B.T204/04.E
40 A	15 kW	48 x 48	KG41.T204/04.E
		64 x 64	KG41B.T204/04.E
63 A	22 kW	48 x 48	KG64.T204/04.E
		64 x 64	KG64B.T204/04.E
80 A	30 kW	64 x 64	KG80.T204/04.E
		88 x 88	KG80C.T204/04.E
100 A	37 kW	64 x 64	KG100.T204/04.E
		88 x 88	KG100C.T204/04.E
125 A	45 kW	88 x 88	KG125.T204/04.E
160 A	55 kW	88 x 88	KG160.T204/04.E
200 A	75 kW	88 x 88	KG210.T204/05.E
250 A	90 kW	88 x 88	KG250.T204/05.E
315 A	110 kW	88 x 88	KG315.T204/05.E
315 A	132 kW	130 x 130	C316.T204/05.E ¹



4-pole



L1 L2 L3 N
T1 T2 T3 N

4-hole (standard)

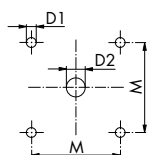

2-hole (alternative)
possible if dimensions "N",
"P" and "D3" are specified

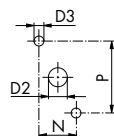

Thermal current (Iu/Ith)	Rating AC-23B (A)	Face plate	Order number
4-pole			
3 x 400 V			
20 A	5,5 kW	48 x 48	KG10A.T104/04.E
		64 x 64	KG10B.T104/04.E
25 A	7,5 kW	48 x 48	KG20A.T104/04.E
		64 x 64	KG20B.T104/04.E
32 A	11 kW	48 x 48	KG32A.T104/04.E
		64 x 64	KG32B.T104/04.E
40 A	15 kW	48 x 48	KG41.T104/04.E
		64 x 64	KG41B.T104/04.E
63 A	22 kW	48 x 48	KG64.T104/04.E
		64 x 64	KG64B.T104/04.E
80 A	30 kW	64 x 64	KG80.T104/04.E
		88 x 88	KG80C.T104/04.E
100 A	37 kW	64 x 64	KG100.T104/04.E
		88 x 88	KG100C.T104/04.E
125 A	45 kW	88 x 88	KG125.T104/04.E
160 A	55 kW	88 x 88	KG160.T104/04.E
200 A	75 kW	88 x 88	KG210.T104/05.E
250 A	90 kW	88 x 88	KG250.T104/05.E
315 A	110 kW	88 x 88	KG315.T104/05.E
315 A	132 kW	130 x 130	C316.T104/05.E ¹

KG10A-KG64B

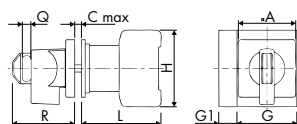

KG80-KG315

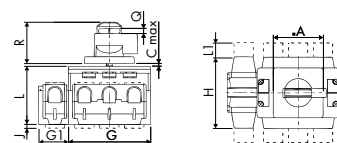

C316

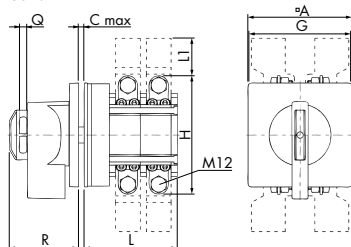

Maximum number of padlocks		
Face plate	Shackle-Ø	Number of padlocks
48 x 48	7	3
	5	4
64 x 64	8	3
	5	4
88 x 88	9	4
130 x 130	9	4

	Switch											Drill hole pattern				
	A	C	G	G1	H	J	L	L1	Q	R	M	N	P	D1	D2	D3
KG10A	48	4	48	0	50		48,2		7,2	51	36	12,2	30	5	11-15	3,5
KG10B	64	4	48	0	50		55,2		8,1	58	48			5	11-15	
KG20A, KG32A	48	4	42	13,5	54		53,8		7,2	51	36	12,2	30	5	10-15	3,5
KG20B, KG32B	64	4	42	13,5	54		53,8		8,1	58	48			5	10-15	
KG41, KG64	48	4	50	16	64		60,5		7,2	51	36			5	10-15	
KG41B	64	4	50	16	64		60,5		8,1	58	48			5	10-15	
KG64B	64	4	50	16	64		60,5		8,1	58	48	14	37	5	10-15	4,5
KG80, KG100	64	4	70	22	80	5,5	70,6	26	8,1	58	48	14	37	5	10-15	4,5
KG80C, KG100C	88	4	70	22	80	5,5	70,6	26	9	73	68			6	10-15	
KG125, KG160	88	5,5	112	38	108		96	22,2	9	73	68			6	13-17	
KG210, KG250	88	5,5	145	52,5	126	6	103	25	9	73	68			6	13-17	
KG315	88	5,5	145	52,5	126	6	103	25	9	73	68			6	13-17	
C316	130	7	128	0	150		117,2	46	9	86,5	104			7	16-20	

¹ Protection IP 40, enhanced protection degree On request

Information about KG switches with bold terminals please see page 75.

MAIN, SAFETY AND MAINTENANCE SWITCH

Four hole panel mounting ▶ 6-pole, IP 66



6-pole

Similar image



Complete items



Thermal current (Iu/Ith)	Rating AC-23B (A)	Face plate	Order number
6-pole			
3 x 400 V			
20 A	5,5 kW	64 x 64	KG10B.T206/01.E
25 A	7,5 kW	64 x 64	KG20B.T206/01.E
32 A	11 kW	64 x 64	KG32B.T206/01.E
40 A	15 kW	64 x 64	KG41B.T206/01.E
63 A	22 kW	64 x 64	KG64B.T206/01.E
80 A	30 kW	64 x 64	KG80.T206/01.E
100 A	37 kW	64 x 64	KG100.T206/01.E
125 A	45 kW	88 x 88	KG125.T206/01.E
160 A	55 kW	88 x 88	KG160.T206/01.E

Thermal current (Iu/Ith)	Rating AC-23B (A)	Face plate	Order number
6-pole			
3 x 400 V			
20 A	5,5 kW	64 x 64	KG10B.T106/01.E
25 A	7,5 kW	64 x 64	KG20B.T106/01.E
32 A	11 kW	64 x 64	KG32B.T106/01.E
40 A	15 kW	64 x 64	KG41B.T106/01.E
63 A	22 kW	64 x 64	KG64B.T106/01.E
80 A	30 kW	64 x 64	KG80.T106/01.E
100 A	37 kW	64 x 64	KG100.T106/01.E
125 A	45 kW	88 x 88	KG125.T106/01.E
160 A	55 kW	88 x 88	KG160.T106/01.E

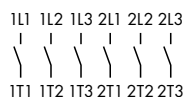

4-hole (standard)

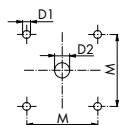

2-hole (alternative)
possible if dimensions "N",
"P" and "D3" are specified

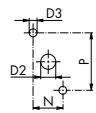

KG10B-KG64B

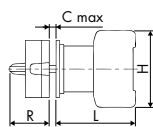

KG10B-KG64B

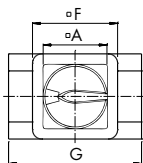

KG80-KG160

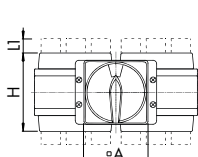
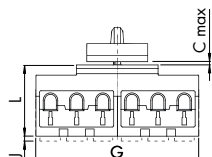

Maximum number of padlocks		
Face plate	Shackle-Ø	Number of padlocks
64 x 64	9	3
88 x 88	10	3

	Switch							Drill hole pattern						
	A	C	G	H	J	L	L1	R	M	N	P	D1	D2	D3
KG10B	64	4	48	50		66,7		40,1	48	12,2	30	5	11-15	3,5
KG20B, KG32B	64	4	84	54		61,3		40,1	48	12,2	30	5	10-15	3,5
KG41B	64	4	100	64		66,5		40,1	48	12,2	30	5	10-15	3,5
KG64B	64	4	100	64		66,5		40,1	48	14	37	5	10-15	4,5
KG80, KG100	64	4	140	80	5,5	81,8	26	40,1	48	14	37	5	10-15	4,5
KG125, KG160	88	5,5	224	108		98	22,2	49,3	68			6	13-17	

Information about KG switches with bold terminals please see page 75.



Four hole panel mounting ▶ 6-pole, IP 66



Similar image



Thermal current (Iu/Ith)	Rating AC-23B (A)	Face plate	Order number
6-pole			
3 x 400 V			
20 A	5,5 kW	48 x 48	KG10A.T206/04.E
		64 x 64	KG10B.T206/04.E
25 A	7,5 kW	64 x 64	KG20B.T206/04.E
32 A	11 kW	64 x 64	KG32B.T206/04.E
40 A	15 kW	64 x 64	KG41B.T206/04.E
63 A	22 kW	64 x 64	KG64B.T206/04.E
80 A	30 kW	64 x 64	KG80.T206/04.E
100 A	37 kW	64 x 64	KG100.T206/04.E
125 A	45 kW	88 x 88	KG125.T206/04.E
160 A	55 kW	88 x 88	KG160.T206/04.E

Thermal current (Iu/Ith)	Rating AC-23B (A)	Face plate	Order number
6-pole			
3 x 400 V			
20 A	5,5 kW	48 x 48	KG10A.T106/04.E
		64 x 64	KG10B.T106/04.E
25 A	7,5 kW	64 x 64	KG20B.T106/04.E
32 A	11 kW	64 x 64	KG32B.T106/04.E
40 A	15 kW	64 x 64	KG41B.T106/04.E
63 A	22 kW	64 x 64	KG64B.T106/04.E
80 A	30 kW	64 x 64	KG80.T106/04.E
100 A	37 kW	64 x 64	KG100.T106/04.E
125 A	45 kW	88 x 88	KG125.T106/04.E
160 A	55 kW	88 x 88	KG160.T106/04.E

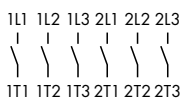

4-hole (standard)

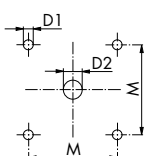

2-hole (alternative)
possible if dimensions "N",
"P" and "D3" are specified

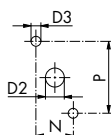

KG10A-KG64B

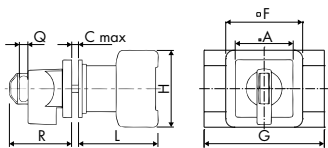

KG80-KG315

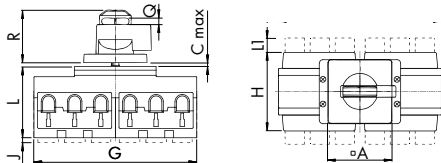

Maximum number of padlocks		
Face plate	Shackle-Ø	Number of padlocks
48 x 48	7	3
	5	4
64 x 64	8	3
	5	4
88 x 88	9	4
130 x 130	9	4

	Switch						Drill hole pattern								
	A	C	G	H	J	L	Q	R	M	N	P	D1	D2	D3	
KG10A	48	4	48	50		57,7		72	51	36	12,2	30	5	11-15	3,5
KG10B	64	4	48	50		66,7		8,1	58	48			5	11-15	
KG20B, KG32B	64	4	84	54		61,3		8,1	58	48			5	10-15	
KG41B, KG64B	64	4	100	64		66,5		8,1	58	48	14	37	5	10-15	4,5
KG80, KG100	64	4	140	80	5,5	81,8	26	8,1	58	48	14	37	5	10-15	4,5
KG125, KG160	88	5,5	224	108		98	22,2	9	73	68			6	13-17	

Information about KG switches with bold terminals please see page 75.

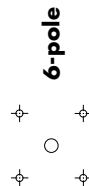

MAIN, SAFETY AND MAINTENANCE SWITCH

Single hole mounting 22 mm ▶ 2- und 3-pole, IP 66, IP 69k



2-/3-pole



Similar image



Thermal current (Iu/Ith)	Rating AC-23B (A)	Face plate	Order number
2-pole			
	230 V		
20 A	1,5 kW	64 x 64	KG10B.T202/01.FT2
3-pole			
	3 x 400 V		
20 A	5,5 kW	64 x 64	KG10B.T203/01.FT2
25 A	7,5 kW	64 x 64	KG20B.T203/01.FT2
32 A	11 kW	64 x 64	KG32B.T203/01.FT2

Thermal current (Iu/Ith)	Rating AC-23B (A)	Face plate	Order number
2-pole			
	230 V		
20 A	1,5 kW	64 x 64	KG10B.T102/01.FT2
3-pole			
	3 x 400 V		
20 A	5,5 kW	64 x 64	KG10B.T103/01.FT2
25 A	7,5 kW	64 x 64	KG20B.T103/01.FT2
32 A	11 kW	64 x 64	KG32B.T103/01.FT2

Complete items

2-pole



3-pole

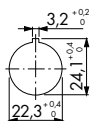

Maximum number of padlocks		
Face plate	Shackle-Ø	Number of padlocks
64 x 64	9	3

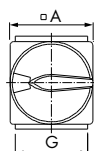
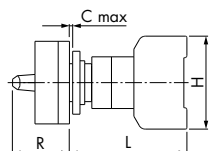

	A	L	G	H	R	C max
KG10B 2-pole	64	64,4	48	50	40,1	6
KG10B 3-pole	64	73,9	48	50	40,1	6
KG20B	64	68,3	42	54	40,1	6
KG32B	64	68,3	42	54	40,1	6



Single hole mounting 22 mm ▶ 2- und 3-pole, IP 66, IP 69k



Similar image



Thermal current (Iu/Ith)	Rating AC-23B (A)	Face plate	Order number
2-pole			
230 V			
20 A	1,5 kW	48 x 48	KG10A.T202/04.FT2
		64 x 64	KG10B.T202/04.FT2
3-pole			
3 x 400 V			
20 A	5,5 kW	48 x 48	KG10A.T203/04.FT2
		64 x 64	KG10B.T203/04.FT2
25 A	7,5 kW	48 x 48	KG20A.T203/04.FT2
		64 x 64	KG20B.T203/04.FT2
32 A	11 kW	48 x 48	KG32A.T203/04.FT2
		64 x 64	KG32B.T203/04.FT2

Thermal current (Iu/Ith)	Rating AC-23B (A)	Face plate	Order number
2-pole			
230 V			
20 A	1,5 kW	48 x 48	KG10A.T102/04.FT2
		64 x 64	KG10B.T102/04.FT2
3-pole			
3 x 400 V			
20 A	5,5 kW	48 x 48	KG10A.T103/04.FT2
		64 x 64	KG10B.T103/04.FT2
25 A	7,5 kW	48 x 48	KG20A.T103/04.FT2
		64 x 64	KG20B.T103/04.FT2
32 A	11 kW	48 x 48	KG32A.T103/04.FT2
		64 x 64	KG32B.T103/04.FT2



2-/3-pole



Complete items

2-pole



3-pole

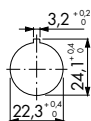

Maximum number of padlocks		
Face plate	Shackle-Ø	Number of padlocks
48 x 48	7	3
	5	4
64 x 64	8	3
	5	4

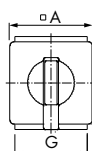
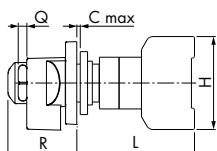

	A	L	G	H	R	Q	C max
KG10A 2-pole	48	57,4	48	50	52	7,2	6
KG10A 3-pole	48	66,9	48	50	52	7,2	6
KG10B 2-pole	64	64,4	48	50	58	8	6
KG10B 3-pole	64	73,9	48	50	58	8	6
KG20A, KG32A	48	68,3	42	54	52	7,2	6
KG20B, KG32B	64	68,3	42	54	58	8	6

MAIN, SAFETY AND MAINTENANCE SWITCH

Single hole mounting 22 mm ▶ 3-pole + 1 NO, IP 66, IP 69k



3-pole +
1NO



Thermal current (Iu/Ith)	Rating AC-23B (A)	Face plate	Order number
3-pole+1NO	3 x 400 V		
20 A	5,5 kW	64 x 64	KG10B.T203/17.FT2
25 A	7,5 kW	64 x 64	KG20B.T203/17.FT2
32 A	11 kW	64 x 64	KG32B.T203/17.FT2

Similar image



Thermal current (Iu/Ith)	Rating AC-23B (A)	Face plate	Order number
3-pole+1NO	3 x 400 V		
20 A	5,5 kW	64 x 64	KG10B.T103/17.FT2
25 A	7,5 kW	64 x 64	KG20B.T103/17.FT2
32 A	11 kW	64 x 64	KG32B.T103/17.FT2

Complete items

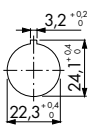
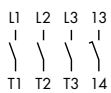

Maximum number of padlocks		
Face plate	Shackle-Ø	Number of padlocks
48 x 48	4	2
	8	1
64 x 64	9	3

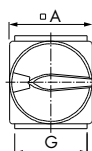
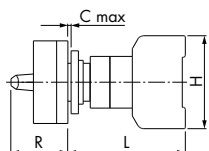

	A	C	G	H	L	R
KG10A	48	6	48	50	66,9	
KG10B	64	6	48	50	73,9	40,1
KG20A, KG32A	48	6	42	54	77,3	
KG20B, KG32B	64	6	42	54	77,3	40,1



Single hole mounting 22 mm ▶ 3-pole + 1 NO, IP 66, IP 69k



Similar image



Thermal current (Iu/Ith)	Rating AC-23B (A)	Face plate	Order number
3-pole+1NO			
3 x 400 V			
20 A	5,5 kW	48 x 48 64 x 64	KG10A.T203/20.FT2 KG10B.T203/20.FT2
25 A	7,5 kW	48 x 48 64 x 64	KG20A.T203/20.FT2 KG20B.T203/20.FT2
32 A	11 kW	48 x 48 64 x 64	KG32A.T203/20.FT2 KG32B.T203/20.FT2

Thermal current (Iu/Ith)	Rating AC-23B (A)	Face plate	Order number
3-pole+1NO			
3 x 400 V			
20 A	5,5 kW	48 x 48 64 x 64	KG10A.T103/20.FT2 KG10B.T103/20.FT2
25 A	7,5 kW	48 x 48 64 x 64	KG20A.T103/20.FT2 KG20B.T103/20.FT2
32 A	11 kW	48 x 48 64 x 64	KG32A.T103/20.FT2 KG32B.T103/20.FT2



3-pole +
1NO



Complete items

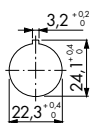

Maximum number of padlocks		
Face plate	Shackle-Ø	Number of padlocks
48 x 48	7	3
	5	4
64 x 64	8	3
	5	4

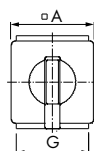
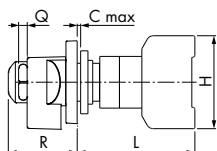

	A	C	G	H	L	R	Q
KG10A	48	6	48	50	66,9	51	7,2
KG10B	64	6	48	50	73,9	58	8
KG20A, KG32A	48	6	42	54	77,3	51	7,2
KG20B, KG32B	64	6	42	54	77,3	58	8

MAIN, SAFETY AND MAINTENANCE SWITCH

Single hole mounting 22 mm ▶ 3-pole + 1 NO + 1 NC, IP 66



3-pole +
1NO + 1 NC



Similar image



Thermal current (I_u/I_{th})	Rating AC-23B (A)	Face plate	Order number
3-pole+ 1NO +1NC	3 x 380 V/440 V		
20 A	5,5 kW	64 x 64	KG10B.T203/A1.FT2
25 A	7,5 kW	64 x 64	KG20B.T203/A1.FT2
32 A	11 kW	64 x 64	KG32B.T203/A1.FT2



Thermal current (I_u/I_{th})	Rating AC-23B (A)	Face plate	Order number
3-pole+ 1NO +1NC	3 x 380 V/440 V		
20 A	5,5 kW	64 x 64	KG10B.T103/A1.FT2
25 A	7,5 kW	64 x 64	KG20B.T103/A1.FT2
32 A	11 kW	64 x 64	KG32B.T103/A1.FT2

Complete items

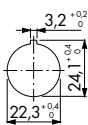

Maximum number of padlocks		
Face plate	Shackle-Ø	Number of padlocks
64 x 64	9	3

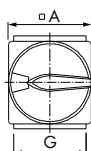
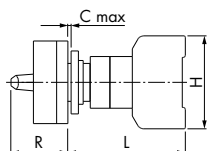

	A	C	G	H	L	R
KG10B	64	6	48	50	75,6	40,1
KG20B, KG32B	64	6	42	54	77,3	40,1



Single hole mounting 22 mm ▶ 3-pole + 1 NO + 1 NC, IP 66



Similar image



Thermal current (I_u/I_{th})	Rating AC-23B (A)	Face plate	Order number
3-pole+ 1NO +1NC	3 x 380 V/440 V		
20 A	5,5 kW	48 x 48 64 x 64	KG10A.T203/A2.FT2 KG10B.T203/A2.FT2
25 A	7,5 kW	48 x 48 64 x 64	KG20A.T203/A2.FT2 KG20B.T203/A2.FT2
32 A	11 kW	48 x 48 64 x 64	KG32A.T203/A2.FT2 KG32B.T203/A2.FT2

Thermal current (I_u/I_{th})	Rating AC-23B (A)	Face plate	Order number
3-pole+ 1NO +1NC	3 x 380 V/440 V		
20 A	5,5 kW	48 x 48 64 x 64	KG10A.T103/A2.FT2 KG10B.T103/A2.FT2
25 A	7,5 kW	48 x 48 64 x 64	KG20A.T103/A2.FT2 KG20B.T103/A2.FT2
32 A	11 kW	48 x 48 64 x 64	KG32A.T103/A2.FT2 KG32B.T103/A2.FT2



3-pole +
1NO + 1 NC



Complete items

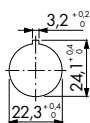

Maximum number of padlocks		
Face plate	Shackle-Ø	Number of padlocks
48 x 48	7	3
	5	4
64 x 64	8	3
	5	4

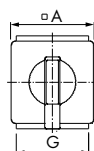
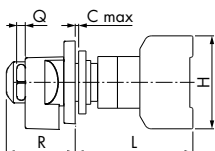

	A	C	G	H	L	R	Q
KG10A	48	6	48	50	75,6	51	7,2
KG10B	64	6	48	50	75,6	58	8
KG20A, KG32A	48	6	42	54	77,3	51	7,2
KG20B, KG32B	64	6	42	54	77,3	58	8

MAIN, SAFETY AND MAINTENANCE SWITCH

Single hole mounting 22 mm ▶ 3-pole + N + PE, IP 66, IP 69k



3-pole +
N + PE

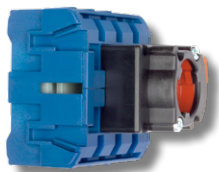

Thermal current (Iu/Ith)	Rating AC-23B (A)	Face plate	Order number
3-pole+N+PE 3 x 400 V			
25 A	7,5 kW	64 x 64	KG20B.T205/01.FT2
32 A	11 kW	64 x 64	KG32B.T205/01.FT2

Similar image



Thermal current (Iu/Ith)	Rating AC-23B (A)	Face plate	Order number
3-pole+N+PE 3 x 400 V			
25 A	7,5 kW	64 x 64	KG20B.T105/01.FT2
32 A	11 kW	64 x 64	KG32B.T105/01.FT2

Complete items

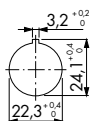
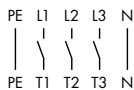

Maximum number of padlocks		
Face plate	Shackle-Ø	Number of padlocks
48 x 48	4	2
	8	1
64 x 64	9	3

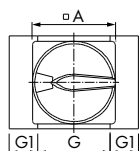
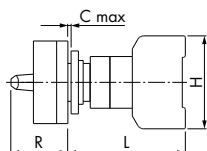

	A	C	G	G1	H	L	R
KG20A, KG32A	48	6	42	13,5	54	68,3	
KG20B, KG32B	64	6	42	13,5	54	68,3	40,1



Single hole mounting 22 mm ▶ 3-pole + N + PE, IP 66, IP 69k

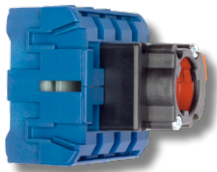

Similar image



Thermal current (Iu/Ith)	Rating AC-23B (A)	Face plate	Order number
3-pole+N+PE 3 x 400 V			
25 A	7,5 kW	48 x 48 64 x 64	KG20A.T205/04.FT2 KG20B.T205/04.FT2
32 A	11 kW	48 x 48 64 x 64	KG32A.T205/04.FT2 KG32B.T205/04.FT2



Thermal current (Iu/Ith)	Rating AC-23B (A)	Face plate	Order number
3-pole+N+PE 3 x 400 V			
25 A	7,5 kW	48 x 48 64 x 64	KG20A.T105/04.FT2 KG20B.T105/04.FT2
32 A	11 kW	48 x 48 64 x 64	KG32A.T105/04.FT2 KG32B.T105/04.FT2



3-pole +
N + PE



Complete items

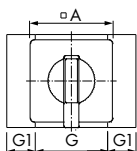
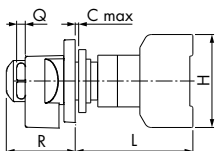
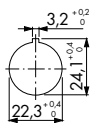
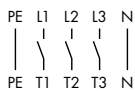

Maximum number of padlocks		
Face plate	Shackle-Ø	Number of padlocks
48 x 48	7	3
	5	4
64 x 64	8	3
	5	4

	A	C	G	G1	H	L	R	Q
KG20A, KG32A	48	6	42	13,5	54	68,3	51	7,2
KG20B, KG32B	64	6	42	13,5	54	68,3	58	8

MAIN, SAFETY AND MAINTENANCE SWITCH

Single hole mounting 22 mm ▶ 4-pole, IP 66, IP 69k

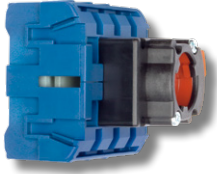

Thermal current (Iu/Ith)	Rating AC-23B (A)	Face plate	Order number
4-pole	3 x 400 V		
20 A	5,5 kW	64 x 64	KG10B.T204/01.FT2
25 A	7,5 kW	64 x 64	KG20B.T204/01.FT2
32 A	11 kW	64 x 64	KG32B.T204/01.FT2

4-pole

Similar image



Thermal current (Iu/Ith)	Rating AC-23B (A)	Face plate	Order number
4-pole	3 x 400 V		
20 A	5,5 kW	64 x 64	KG10B.T104/01.FT2
25 A	7,5 kW	64 x 64	KG20B.T104/01.FT2
32 A	11 kW	64 x 64	KG32B.T104/01.FT2

Complete items

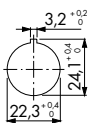
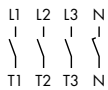

Maximum number of padlocks		
Face plate	Shackle-Ø	Number of padlocks
64 x 64	9	3

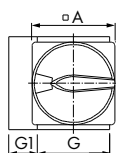
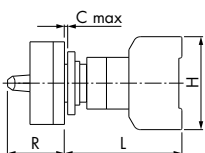

	A	L	G	G1	H	R	C max
KG10B	64	73,9	48	0	50	40,1	6
KG20B	64	68,3	42	13,5	54	40,1	6
KG32B	64	68,3	42	13,5	54	40,1	6



Single hole mounting 22 mm ▶ 4-pole, IP 66, IP 69k

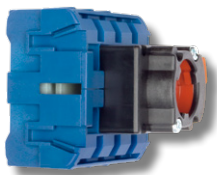

Similar image



Thermal current (lu/lth)	Rating AC-23B (A)	Face plate	Order number
4-pole			
3 x 400 V			
20 A	5,5 kW	48 x 48	KG10A.T204/04.FT2
		64 x 64	KG10B.T204/04.FT2
25 A	7,5 kW	48 x 48	KG20A.T204/04.FT2
		64 x 64	KG20B.T204/04.FT2
32 A	11 kW	48 x 48	KG32A.T204/04.FT2
		64 x 64	KG32B.T204/04.FT2



Thermal current (lu/lth)	Rating AC-23B (A)	Face plate	Order number
4-pole			
3 x 400 V			
20 A	5,5 kW	48 x 48	KG10A.T104/04.FT2
		64 x 64	KG10B.T104/04.FT2
25 A	7,5 kW	48 x 48	KG20A.T104/04.FT2
		64 x 64	KG20B.T104/04.FT2
32 A	11 kW	48 x 48	KG32A.T104/04.FT2
		64 x 64	KG32B.T104/04.FT2



4-pole



Complete items

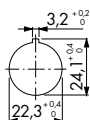
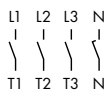

Maximum number of padlocks		
Face plate	Shackle-Ø	Number of padlocks
48 x 48	7	3
	5	4
64 x 64	8	3
	5	4

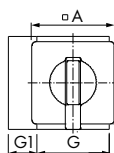
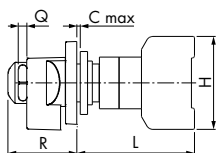

	A	L	G	G1	H	R	Q	C max
KG10A	48	66,9	48	0	50	52	7,2	6
KG10B	64	73,9	48	0	50	58	8	6
KG20A, KG32A	48	68,3	42	13,5	54	52	7,2	6
KG20B, KG32B	64	68,3	42	13,5	54	58	8	6

MAIN, SAFETY AND MAINTENANCE SWITCH

Intergrated door clutch for enclosures ▶ 3-pole, IP 66 / 67



3-pole



Complete items



Similar image



Thermal current (Iu/Ith)	Rating AC-23B (A)	Face plate	Order number
3-pole			
3 x 400 V			
20 A	5,5 kW	64 x 64	KG10B.T203/09.VE
25 A	7,5 kW	64 x 64	KG20B.T203/09.VE
32 A	11 kW	64 x 64	KG32B.T203/09.VE
40 A	15 kW	64 x 64	KG41B.T203/09.VE
63 A	22 kW	64 x 64	KG64B.T203/09.VE
80 A	30 kW	64 x 64	KG80.T203/09.VE
100 A	37 kW	64 x 64	KG100.T203/09.VE
125 A	45 kW	88 x 88	KG125.T203/09.VE
160 A	55 kW	88 x 88	KG160.T203/09.VE

Thermal current (Iu/Ith)	Rating AC-23B (A)	Face plate	Order number
3-pole			
3 x 400 V			
20 A	5,5 kW	64 x 64	KG10B.T103/09.VE
25 A	7,5 kW	64 x 64	KG20B.T103/09.VE
32 A	11 kW	64 x 64	KG32B.T103/09.VE
40 A	15 kW	64 x 64	KG41B.T103/09.VE
63 A	22 kW	64 x 64	KG64B.T103/09.VE
80 A	30 kW	64 x 64	KG80.T103/09.VE
100 A	37 kW	64 x 64	KG100.T103/09.VE
125 A	45 kW	88 x 88	KG125.T103/09.VE
160 A	55 kW	88 x 88	KG160.T103/09.VE



Drill hole pattern face plate

up to KG100

KG125-KG160

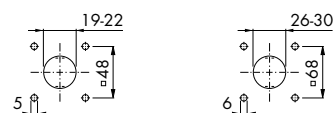

Drill hole pattern base (mounting on DIN rail up to KG100)

KG10B

KG20B-KG100

KG125-KG160

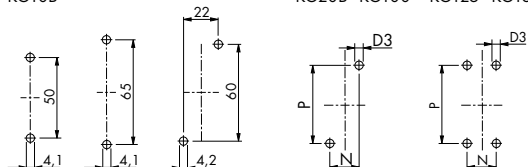

Maximum number of padlocks		
Face plate	Shackle-Ø	Number of padlocks
64 x 64	9	3
88 x 88	10	3

KG10B-KG64B

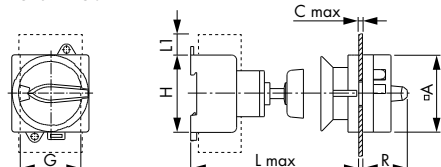

KG80-KG160

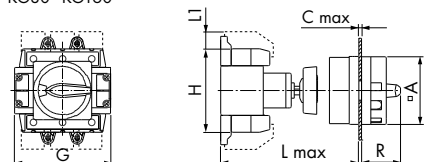

	N	P	D3
KG20B, KG32B	22	60	4,1
KG41B, KG64B	25	70	4,1
KG80, KG100	25	90	5,2
KG125, KG160	36	120	6,4

	A	C	G	H	L	L1	R
KG10B	64	4	48	50	190		40,1
KG20B, KG32B	64	4	42	54	190		40,1
KG41B	64	4	50	64	190		40,1
KG64B	64	4	50	64	330		40,1
KG80	64	4	70	80	380	26	40,1
KG100	64	4	70	80	450	26	40,1
KG125, KG160	88	5,5	112	108	450	22,2	49,3

Information about KG switches with bold terminals please see page 75.



Switch cabinet mounting with door clutch ▶ 3-pole, IP 66



Similar image

Thermal current (Iu/Ith)	Rating AC-23B (A)	Face plate	Order number
3-pole			
3 x 400 V			
40 A	15 kW	88 x 88	KG41B.T203/12.VE
63 A	22 kW	88 x 88	KG64B.T203/12.VE
80 A	30 kW	88 x 88	KG80.T203/12.VE
100 A	37 kW	88 x 88	KG100.T203/12.VE
125 A	45 kW	88 x 88	KG125.T203/12.VE
160 A	55 kW	88 x 88	KG160.T203/12.VE
200 A	75 kW	88 x 88	KG210.T203/13.VE
250 A	90 kW	88 x 88	KG250.T203/13.VE
315 A	110 kW	88 x 88	KG315.T203/13.VE
315 A	132 kW	88 x 88	C316.T203/13.VE



3-pole



Thermal current (Iu/Ith)	Rating AC-23B (A)	Face plate	Order number
3-pole			
3 x 400 V			
40 A	15 kW	88 x 88	KG41B.T103/12.VE
63 A	22 kW	88 x 88	KG64B.T103/12.VE
80 A	30 kW	88 x 88	KG80.T103/12.VE
100 A	37 kW	88 x 88	KG100.T103/12.VE
125 A	45 kW	88 x 88	KG125.T103/12.VE
160 A	55 kW	88 x 88	KG160.T103/12.VE
200 A	75 kW	88 x 88	KG210.T103/13.VE
250 A	90 kW	88 x 88	KG250.T103/13.VE
315 A	110 kW	88 x 88	KG315.T103/13.VE
315 A	132 kW	88 x 88	C316.T103/13.VE

Unlock insert for door clutch M700/.

[SID.M700.29](#)



Enables door opening in „On“ position and permanently defeating the interlock. (After inactivation the interlock it is mandatory to take effective precaution measures to prevent unauthorized person from opening the door.)

Drill hole pattern face plate

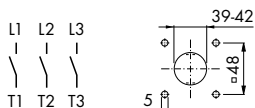

Drill hole pattern base (mounting on DIN rail up to KG100)

KG41B–KG100

KG125–C316

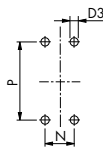
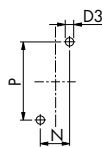

KG

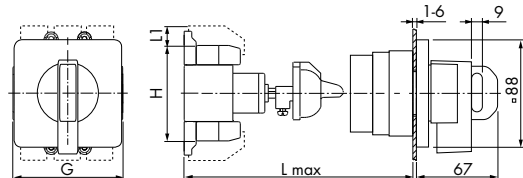

C316

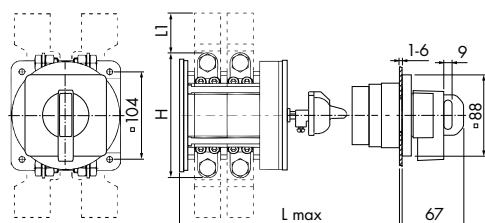

Maximum number of padlocks		
Face plate	Shackle-∅	Number of padlocks
88 x 88	5	4
	8	3

	N	P	D3
KG41B, KG64B	25	70	4,1
KG80, KG100	25	90	5,2
KG125, KG160	36	120	6,4
KG210–KG315	44	142	6,4
C316	104	104	7

	G	H	L	L1
KG41B	50	64	190	
KG64B	50	64	330	
KG80	70	80	380	26
KG100	70	80	450	26
KG125, KG160	112	108	450	22,2
KG210–KG315	145	126	550	25
C316	128	150	550	46

Information about KG switches with bold terminals please see page 75.

MAIN, SAFETY AND MAINTENANCE SWITCH

Integrated door clutch for enclosures ▶ 3-pole + 1 NO, IP 66 / 67



3-pole + 1NO



Complete items

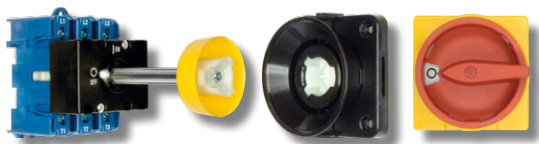

Similar image



Thermal current (Iu/Ith)	Rating AC-23B (A)	Face plate	Order number
3-pole + 1NO	3 x 400 V		
20 A	5,5 kW	64 x 64	KG10B.T203/25.VE
25 A	7,5 kW	64 x 64	KG20B.T203/25.VE
32 A	11 kW	64 x 64	KG32B.T203/25.VE
40 A	15 kW	64 x 64	KG41B.T203/25.VE
63 A	22 kW	64 x 64	KG64B.T203/25.VE
80 A	30 kW	64 x 64	KG80.T203/25.VE
100 A	37 kW	64 x 64	KG100.T203/25.VE
125 A	45 kW	88 x 88	KG125.T203/25.VE
160 A	55 kW	88 x 88	KG160.T203/25.VE

Thermal current (Iu/Ith)	Rating AC-23B (A)	Face plate	Order number
3-pole + 1NO	3 x 400 V		
20 A	5,5 kW	64 x 64	KG10B.T103/25.VE
25 A	7,5 kW	64 x 64	KG20B.T103/25.VE
32 A	11 kW	64 x 64	KG32B.T103/25.VE
40 A	15 kW	64 x 64	KG41B.T103/25.VE
63 A	22 kW	64 x 64	KG64B.T103/25.VE
80 A	30 kW	64 x 64	KG80.T103/25.VE
100 A	37 kW	64 x 64	KG100.T103/25.VE
125 A	45 kW	88 x 88	KG125.T103/25.VE
160 A	55 kW	88 x 88	KG160.T103/25.VE

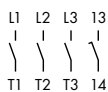

Drill hole pattern face plate

up to KG100

KG125-KG160

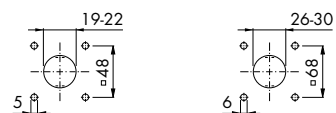

Drill hole pattern base (mounting on DIN rail up to KG100)

KG10B

KG20B-KG100

KG125-KG160

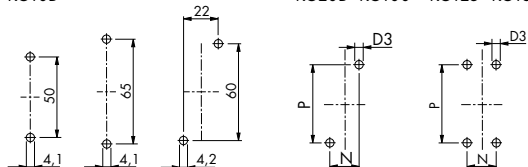

Maximum number of padlocks		
Face plate	Shackle-Ø	Number of padlocks
64 x 64	9	3
88 x 88	10	3

KG10B-KG64B

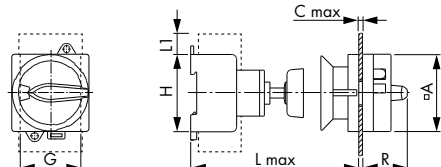

KG80-KG160

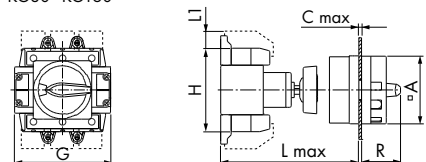

	N	P	D3
KG20B, KG32B	22	60	4,1
KG41B, KG64B	25	70	4,1
KG80, KG100	25	90	5,2
KG125, KG160	36	120	6,4

	A	C	G	H	L	L1	R
KG10B	64	4	48	50	190		40,1
KG20B, KG32B	64	4	42	54	190		40,1
KG41B	64	4	50	64	190		40,1
KG64B	64	4	50	64	330		40,1
KG80	64	4	70	80	380	26	40,1
KG100	64	4	70	80	450	26	40,1
KG125, KG160	88	5,5	112	108	450	22,2	49,3

Information about KG switches with bold terminals please see page 75.



Switch cabinet mounting with door clutch ▶ 3-pole + 1 NO, IP 66



Similar image

Thermal current (Iu/Ith)	Rating AC-23B (A)	Face plate	Order number
3-pole +1NO	3 x 400 V		
40 A	15 kW	88 x 88	KG41B.T203/28.VE
63 A	22 kW	88 x 88	KG64B.T203/28.VE
80 A	30 kW	88 x 88	KG80.T203/28.VE
100 A	37 kW	88 x 88	KG100.T203/28.VE
125 A	45 kW	88 x 88	KG125.T203/28.VE
160 A	55 kW	88 x 88	KG160.T203/28.VE
200 A	75 kW	88 x 88	KG210.T203/29.VE
250 A	90 kW	88 x 88	KG250.T203/29.VE
315 A	110 kW	88 x 88	KG315.T203/29.VE
315 A	132 kW	88 x 88	C316.T203/29.VE



Thermal current (Iu/Ith)	Rating AC-23B (A)	Face plate	Order number
3-pole	3 x 400 V		
40 A	15 kW	88 x 88	KG41B.T103/28.VE
63 A	22 kW	88 x 88	KG64B.T103/28.VE
80 A	30 kW	88 x 88	KG80.T103/28.VE
100 A	37 kW	88 x 88	KG100.T103/28.VE
125 A	45 kW	88 x 88	KG125.T103/28.VE
160 A	55 kW	88 x 88	KG160.T103/28.VE
200 A	75 kW	88 x 88	KG210.T103/29.VE
250 A	90 kW	88 x 88	KG250.T103/29.VE
315 A	110 kW	88 x 88	KG315.T103/29.VE
315 A	132 kW	88 x 88	C316.T103/29.VE

Unlock insert for door clutch M700/.

S1D M700 29



Enables door opening in „On“ position and permanently defeating the interlock. (After inactivation the interlock it is mandatory to take effective precaution measures to prevent unauthorized person from opening the door.)

KG C316 Drill hole pattern face plate

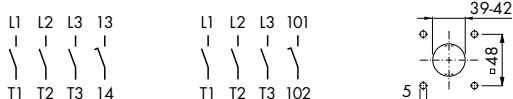

Drill hole pattern base (Mounting on DIN rail up to KG100)

KG41B-KG100 KG125-C316



KG

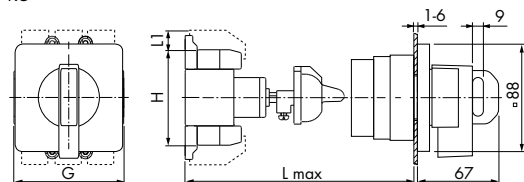

C316

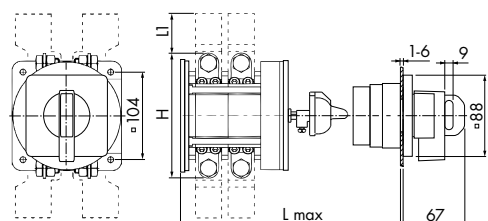

Face plate	Maximum number of padlocks	
	Shackle-Ø	Number of padlocks
88 x 88	5	4
	8	3

	N	P	D3
KG41B, KG64B	25	70	4,1
KG80, KG100	25	90	5,2
KG125, KG160	36	120	6,4
KG210-KG315	44	142	6,4
C316	104	104	7

	G	H	L	L1
KG41B	50	64	190	
KG64B	50	64	330	
KG80	70	80	380	26
KG100	70	80	450	26
KG125, KG160	112	108	450	22,2
KG210-KG315	145	126	550	25
C316	128	150	550	46

Information about KG switches with bold terminals please see page 75.



MAIN, SAFETY AND MAINTENANCE SWITCH

Integrated door clutch for enclosures ▶ 3-pole + 1 NO + 1 NC, IP 66/67



3-pole +
1NO + 1 NC

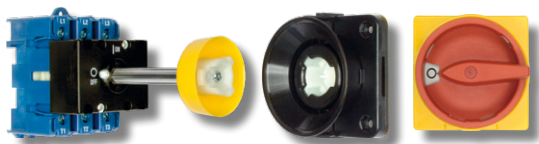

Similar image



Complete items



Thermal current (I_U/I_{th})	Rating AC-23B (A)	Face plate	Order number
3-pole+1NO+1NC	3 x 380 V/440 V		
20 A	5,5 kW	64 x 64	KG10B.T203/A8.VE
25 A	7,5 kW	64 x 64	KG20B.T203/A8.VE
32 A	11 kW	64 x 64	KG32B.T203/A8.VE
40 A	15 kW	64 x 64	KG41B.T203/A8.VE
63 A	22 kW	64 x 64	KG64B.T203/A8.VE
80 A	30 kW	64 x 64	KG80.T203/A8.VE
100 A	37 kW	64 x 64	KG100.T203/A8.VE
125 A	45 kW	88 x 88	KG125.T203/A8.VE
160 A	55 kW	88 x 88	KG160.T203/A8.VE

Thermal current (I_U/I_{th})	Rating AC-23B (A)	Face plate	Order number
3-pole+1NO+1NC	3 x 380 V/440 V		
20 A	5,5 kW	64 x 64	KG10B.T103/A8.VE
25 A	7,5 kW	64 x 64	KG20B.T103/A8.VE
32 A	11 kW	64 x 64	KG32B.T103/A8.VE
40 A	15 kW	64 x 64	KG41B.T103/A8.VE
63 A	22 kW	64 x 64	KG64B.T103/A8.VE
80 A	30 kW	64 x 64	KG80.T103/A8.VE
100 A	37 kW	64 x 64	KG100.T103/A8.VE
125 A	45 kW	88 x 88	KG125.T103/A8.VE
160 A	55 kW	88 x 88	KG160.T103/A8.VE

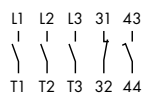

Drill hole pattern face plate

up to KG100

KG125-KG160

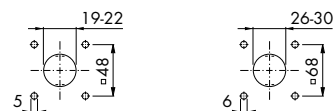

Drill hole pattern base (mounting on DIN rail up to KG100)

KG10B

KG20B-KG100

KG125-KG160

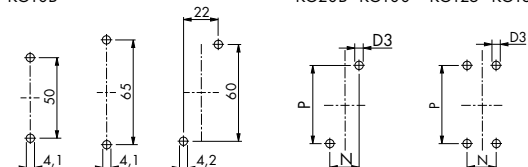

Maximum number of padlocks		
Face plate	Shackle-Ø	Number of padlocks
64 x 64	9	3
88 x 88	10	3

KG10B-KG64B

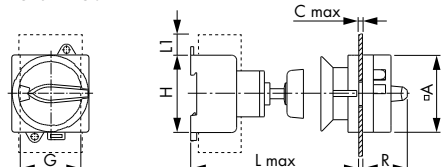

KG80-KG160

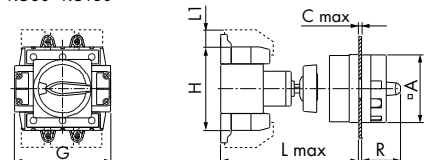

	N	P	D3
KG20B, KG32B	22	60	4,1
KG41B, KG64B	25	70	4,1
KG80, KG100	25	90	5,2
KG125, KG160	36	120	6,4

	A	C	G	H	L	L1	R
KG10B	64	4	48	50	190		40,1
KG20B, KG32B	64	4	42	54	190		40,1
KG41B	64	4	50	64	190		40,1
KG64B	64	4	50	64	330		40,1
KG80	64	4	70	80	380	26	40,1
KG100	64	4	70	80	450	26	40,1
KG125, KG160	88	5,5	112	108	450	22,2	49,3

Information about KG switches with bold terminals please see page 75.



Intergrated door clutch for enclosures ▶ 3-pole + 1 NO + 1 NC, IP 66/67

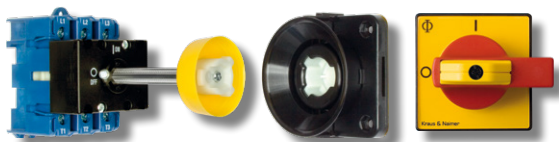

Similar image



Thermal current (I_u/I_{th})	Rating AC-23B (A)	Face plate	Order number
3-pole+1NO+1NC	3 x 380 V/440 V		
20 A	5,5 kW	48 x 48 64 x 64	KG10A.T203/A9.VE KG10B.T203/A9.VE
25 A	7,5 kW	48 x 48 64 x 64	KG20A.T203/A9.VE KG20B.T203/A9.VE
32 A	11 kW	48 x 48 64 x 64	KG32A.T203/A9.VE KG32B.T203/A9.VE
40 A	15 kW	64 x 64	KG41B.T203/A9.VE
63 A	22 kW	64 x 64	KG64B.T203/A9.VE
80 A	30 kW	64 x 64	KG80.T203/A9.VE
100 A	37 kW	64 x 64	KG100.T203/A9.VE

Thermal current (I_u/I_{th})	Rating AC-23B (A)	Face plate	Order number
3-pole+1NO+1NC	3 x 380 V/440 V		
20 A	5,5 kW	48 x 48 64 x 64	KG10A.T203/A9.VE KG10B.T203/A9.VE
25 A	7,5 kW	48 x 48 64 x 64	KG20A.T203/A9.VE KG20B.T203/A9.VE
32 A	11 kW	48 x 48 64 x 64	KG32A.T203/A9.VE KG32B.T203/A9.VE
40 A	15 kW	64 x 64	KG41B.T203/A9.VE
63 A	22 kW	64 x 64	KG64B.T203/A9.VE
80 A	30 kW	64 x 64	KG80.T203/A9.VE
100 A	37 kW	64 x 64	KG100.T203/A9.VE

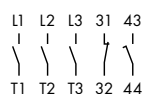

Drill hole pattern face plate

KG10A, KG20A, KG32A KG10B-KG64B, KG80, KG100

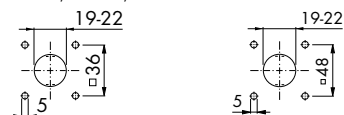

Drill hole pattern base (mounting on DIN rail possible)

KG10A KG20A-KG100

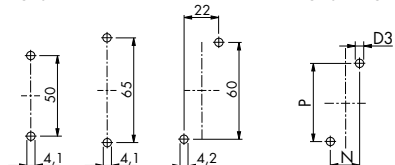

KG10A-KG64B

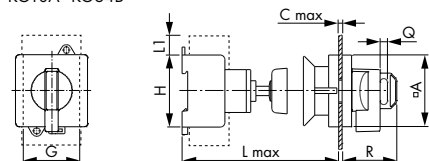

KG80-KG100

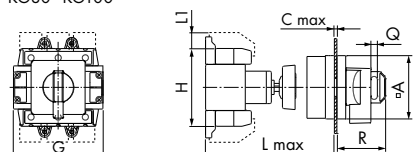

Maximum number of padlocks		
Face plate	Shackle-Ø	Number of padlocks
48 x 48	7	3
	5	4
	8	3
64 x 64	5	4

	N	P	D3
KG20A, KG32A, KG20B, KG32B	22	60	4,1
KG41B, KG64B	25	70	4,1
KG80, KG100	25	90	5,2

	A	C	G	H	L	L1	R	Q
KG10A	48	4	48	50	190		51	7,2
KG10B	64	4	48	50	190		58	8,1
KG20A, KG32A	48	4	42	54	190		51	7,2
KG20B, KG32B	64	4	42	54	190		58	8,1
KG41B	64	4	50	64	190		58	8,1
KG64B	64	4	50	64	330		58	8,1
KG80	64	4	70	80	380	26	58	8,1
KG100	64	4	70	80	450	26	58	8,1

Information about KG switches with bold terminals please see page 75.

3-pole + 1NO + 1 NC



Complete items

Switch cabinet mounting with door clutch ▶ 3-pole + 1 NO + 1 NC, IP 66



3-pole +
1NO + 1 NC



Similar image



Complete items



Thermal current (I_n/I_{th})	Rating AC-23B (A)	Face plate	Order number
3-pole+ 1NO +1NC	3 x 380 V/440 V		
25 A	7,5 kW	88 x 88	KG20B.T203/B1.VE
32 A	11 kW	88 x 88	KG32B.T203/B1.VE
40 A	15 kW	88 x 88	KG41B.T203/B1.VE
63 A	22 kW	88 x 88	KG64B.T203/B1.VE
80 A	30 kW	88 x 88	KG80.T203/B1.VE
100 A	37 kW	88 x 88	KG100.T203/B1.VE
125 A	45 kW	88 x 88	KG125.T203/B1.VE
160 A	55 kW	88 x 88	KG160.T203/B1.VE
200 A	75 kW	88 x 88	KG210.T203/B2.VE
250 A	90 kW	88 x 88	KG250.T203/B2.VE
315 A	110 kW	88 x 88	KG315.T203/B2.VE
315 A	132 kW	88 x 88	C316.T203/B2.VE

Thermal current (I_n/I_{th})	Rating AC-23B (A)	Face plate	Order number
3-pole+ 1NO +1NC	3 x 380 V/440 V		
25 A	7,5 kW	88 x 88	KG20B.T103/B1.VE
32 A	11 kW	88 x 88	KG32B.T103/B1.VE
40 A	15 kW	88 x 88	KG41B.T103/B1.VE
63 A	22 kW	88 x 88	KG64B.T103/B1.VE
80 A	30 kW	88 x 88	KG80.T103/B1.VE
100 A	37 kW	88 x 88	KG100.T103/B1.VE
125 A	45 kW	88 x 88	KG125.T103/B1.VE
160 A	55 kW	88 x 88	KG160.T103/B1.VE
200 A	75 kW	88 x 88	KG210.T103/B2.VE
250 A	90 kW	88 x 88	KG250.T103/B2.VE
315 A	110 kW	88 x 88	KG315.T103/B2.VE
315 A	132 kW	88 x 88	C316.T103/B2.VE

KG

C316

Drill hole pattern
face plate

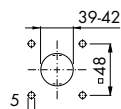
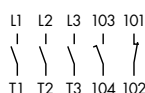
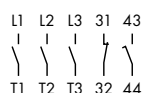

Drill hole pattern base (Mounting on DIN rail up to KG100)

KG20B-KG100

KG125-C316

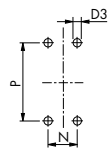
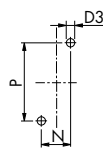

KG20B-KG315

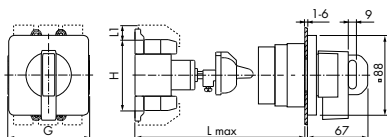

C316

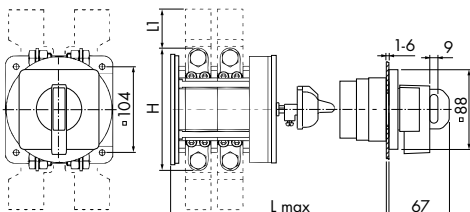

Unlock insert for door clutch M700/.

SID.M700.29



Enables door opening in „On“ position and permanently defeating the interlock. (After inactivation the interlock it is mandatory to take effective precaution measures to prevent unauthorized person from opening the door.)

Face plate	Maximum number of padlocks	
	Shackle-Ø	Number of padlocks
88 x 88	5	4
	8	3

	N	P	D3
KG20B, KG32B	22	60	4,1
KG41B, KG64B	25	70	4,1
KG80, KG100	25	90	5,2
KG125, KG160	36	120	6,4
KG210-KG315	44	142	6,4
C316	104	104	7

	G	H	L	L1
KG20B, KG32B	42	54	190	
KG41B	50	64	190	
KG64B	50	64	330	
KG80	70	80	380	26
KG100	70	80	450	26
KG125, KG160	112	108	450	22,2
KG210-KG315	145	126	550	25
C316	128	150	550	46

Informationen zu KG-Schaltern mit Bolzenanschlüssen finden Sie auf Seite 75.



Integrated door clutch for enclosures ▶ 3-pole + 1 NO H-bridge Gold, IP 66 / 67

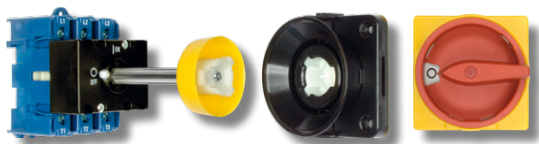

Similar image



Thermal current (Iu/Ith)	Rating AC-23B (A)	Face plate	Order number
3-pole		3 x 400 V	
25 A	7,5 kW	64 x 64	KG20B.T203/D-A283.VE
32 A	11 kW	64 x 64	KG32B.T203/D-A188.VE
40 A	15 kW	64 x 64	On request
63 A	22 kW	64 x 64	On request
80 A	30 kW	64 x 64	KG80.T203/D-A157.VE
100 A	37 kW	64 x 64	KG100.T203/D-A223.VE
125 A	45 kW	88 x 88	KG125.T203/D-A107.VE
160 A	55 kW	88 x 88	On request

Thermal current (Iu/Ith)	Rating AC-23B (A)	Face plate	Order number
3-pole		3 x 400 V	
25 A	7,5 kW	64 x 64	On request
32 A	11 kW	64 x 64	On request
40 A	15 kW	64 x 64	On request
63 A	22 kW	64 x 64	On request
80 A	30 kW	64 x 64	On request
100 A	37 kW	64 x 64	On request
125 A	45 kW	88 x 88	On request
160 A	55 kW	88 x 88	On request



Drill hole pattern face plate

up to KG100

KG125-KG160

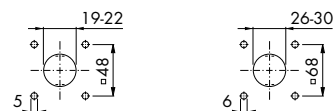

Drill hole pattern base (mounting on DIN rail up to KG100)

KG20B-KG100

KG125-KG160

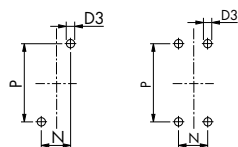

KG20B-KG64B

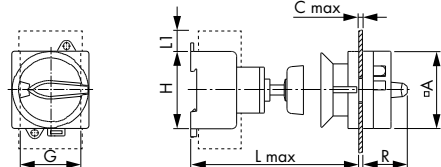

KG80-KG160

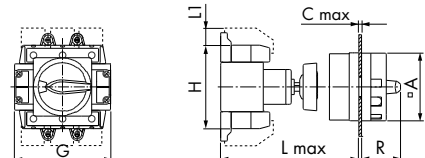

Notice:

Highest contact reliability by H-bridge design with self-cleaning „cross-wire“ contacts. Gold plated for low voltage, low current applications.

Exception: KG20B and KG32B instead H-bridge design equipped with multiple connecting contacts, KG41B and KG64B instead H-bridge design equipped with multiple connecting contacts.

Maximum number of padlocks

Face plate	Shackle-Ø	Number of padlocks
64 x 64	9	3
88 x 88	10	3

	N	P	D3
KG20B, KG32B	22	60	4,1
KG41B, KG64B	25	70	4,1
KG80, KG100	25	90	5,2
KG125, KG160	36	120	6,4

	A	C	G	H	L	L1	R
KG20B, KG32B	64	4	42	54	190		40,1
KG41B	64	4	50	64	190		40,1
KG64B	64	4	50	64	330		40,1
KG80	64	4	70	80	380	26	40,1
KG100	64	4	70	80	450	26	40,1
KG125, KG160	88	5,5	112	108	450	22,2	49,3

Information about KG switches with bold terminals please see page 75.



3-pole + 1NO
H-bridge Gold



Complete items

Switch cabinet mounting with door clutch ▶ 3-pole + 1 NO H-bridge Gold, IP 66



3-pole + 1NO
H-bridge Gold



Similar image



Complete items



Thermal current (Iu/Ith)	Rating AC-23B (A)	Face plate	Order number
3-pole			
3 x 400 V			
100 A	37 kW	88 x 88	KG100.T203/D-A052.VE
125 A	45 kW	88 x 88	KG125.T203/D-A023.VE
160 A	55 kW	88 x 88	KG160.T203/D-A018.VE
200 A	75 kW	88 x 88	KG210.T203/D-A004.VE
250 A	90 kW	88 x 88	KG250.T203/D-A011.VE
315 A	110 kW	88 x 88	KG315.T203/D-A007.VE
315 A	132 kW	88 x 88	C316.T203/D-A012.VE

Thermal current (Iu/Ith)	Rating AC-23B (A)	Face plate	Order number
3-pole			
3 x 400 V			
100 A	37 kW	88 x 88	KG100.T103/D-A018.VE
125 A	45 kW	88 x 88	KG125.T103/D-A014.VE
160 A	55 kW	88 x 88	KG160.T103/D-A014.VE
200 A	75 kW	88 x 88	KG210.T103/D-A003.VE
250 A	90 kW	88 x 88	KG250.T103/D-A017.VE
315 A	110 kW	88 x 88	KG315.T103/D-A007.VE
315 A	132 kW	88 x 88	C316.T103/D-A012.VE

Unlock insert for door clutch M700/.

SID.M700.29

Enables door opening in „On“ position and permanently defeating the interlock. (After inactivation the interlock it is mandatory to take effective precaution measures to prevent unauthorized person from opening the door.)



Drill hole pattern face plate

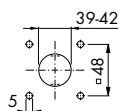
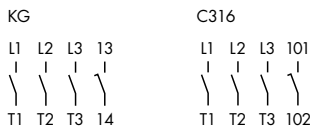

Notice:

Highest contact reliability by H-bridge design with self-cleaning „cross-wire“ contacts. Gold plated for low voltage, low current applications.

Exception: C316 instead H-bridge Gold design equipped with connecting contacts.

Drill hole pattern base (mounting on DIN rail up to KG100)

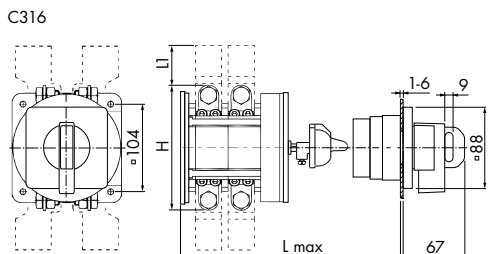
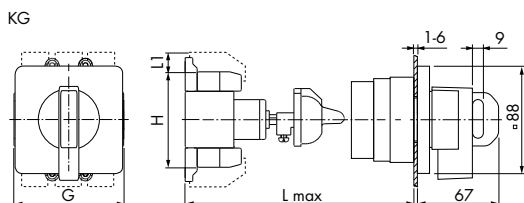
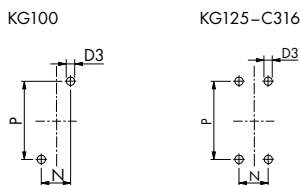

Maximum number of padlocks		
Face plate	Shackle-Ø	Number of padlocks
88 x 88	5	4
	8	3

	N	P	D3
KG100	25	90	5,2
KG125, KG160	36	120	6,4
KG210-KG315	44	142	6,4
C316	104	104	7

	D	G	H	L	L1	N	P
KG100	5,2	70	80	450	26	25	90
KG125, KG160	6,4	112	108	450	22,2	36	120
KG210 - KG315	6,4	145	126	550	25	44	142
C316	7	128	150	550	46	104	104

Information about KG switches with bold terminals please see page 75.



Integrated door clutch for enclosures ▶ 4-pole, IP 66 / 67

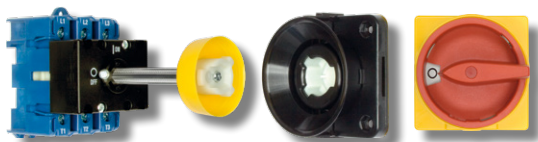

Similar image



Thermal current (Iu/Ith)	Rating AC-23B (A)	Face plate	Order number
4-pole			
3 x 400 V			
20 A	5,5 kW	64 x 64	KG10B.T204/09.VE
25 A	7,5 kW	64 x 64	KG20B.T204/09.VE
32 A	11 kW	64 x 64	KG32B.T204/09.VE
40 A	15 kW	64 x 64	KG41B.T204/09.VE
63 A	22 kW	64 x 64	KG64B.T204/09.VE
80 A	30 kW	64 x 64	KG80.T204/09.VE
100 A	37 kW	64 x 64	KG100.T204/09.VE
125 A	45 kW	88 x 88	KG125.T204/09.VE
160 A	55 kW	88 x 88	KG160.T204/09.VE

Thermal current (Iu/Ith)	Rating AC-23B (A)	Face plate	Order number
4-pole			
3 x 400 V			
20 A	5,5 kW	64 x 64	KG10B.T104/09.VE
25 A	7,5 kW	64 x 64	KG20B.T104/09.VE
32 A	11 kW	64 x 64	KG32B.T104/09.VE
40 A	15 kW	64 x 64	KG41B.T104/09.VE
63 A	22 kW	64 x 64	KG64B.T104/09.VE
80 A	30 kW	64 x 64	KG80.T104/09.VE
100 A	37 kW	64 x 64	KG100.T104/09.VE
125 A	45 kW	88 x 88	KG125.T104/09.VE
160 A	55 kW	88 x 88	KG160.T104/09.VE



Drill hole pattern face plate

up to KG100

KG125-KG160

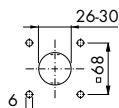
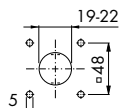

Drill hole pattern base (mounting on DIN rail up to KG100)

KG10B

KG20B-KG100

KG125-KG160

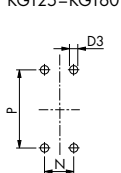
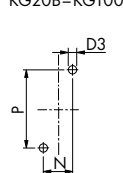
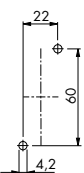
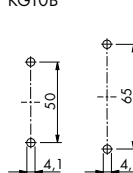

Maximum number of padlocks		
Face plate	Shackle-Ø	Number of padlocks
64 x 64	9	3
88 x 88	10	3

KG10B-KG64B

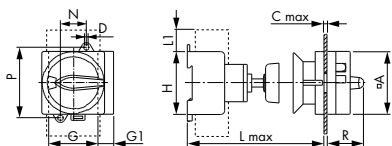

KG80-KG160

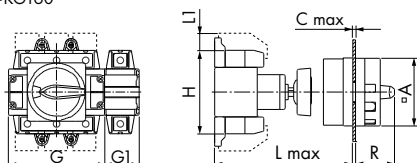

	N	P	D3
KG20B, KG32B	22	60	4,1
KG41B, KG64B	25	70	4,1
KG80, KG100	25	90	5,2
KG125, KG160	36	120	6,4

	A	C	G	G1	H	L	L1	R
KG10B	64	4	48	0	50	190		40,1
KG20B, KG32B	64	4	42	13,5	54	190		40,1
KG41B	64	4	50	16	64	190		40,1
KG64B	64	4	50	16	64	330		40,1
KG80	64	4	70	22	80	380	26	40,1
KG100	64	4	70	22	80	450	26	40,1
KG125, KG160	88	5,5	112	38	108	450	22,2	49,3

Information about KG switches with bold terminals please see page 75.

Switch cabinet mounting with door clutch ▶ 4-pole, IP 66

4-pole



Complete items



Similar image

Thermal current (Iu/Ith)	Rating AC-23B (A)	Face plate	Order number
4-pole			
3 x 400 V			
40 A	15 kW	88 x 88	KG41B.T204/12.VE
63 A	22 kW	88 x 88	KG64B.T204/12.VE
80 A	30 kW	88 x 88	KG80.T204/12.VE
100 A	37 kW	88 x 88	KG100.T204/12.VE
125 A	45 kW	88 x 88	KG125.T204/12.VE
160 A	55 kW	88 x 88	KG160.T204/12.VE
200 A	75 kW	88 x 88	KG210.T204/13.VE
250 A	90 kW	88 x 88	KG250.T204/13.VE
315 A	110 kW	88 x 88	KG315.T204/13.VE
315 A	132 kW	88 x 88	C316.T204/13.VE



Thermal current (Iu/Ith)	Rating AC-23B (A)	Face plate	Order number
4-pole			
3 x 400 V			
40 A	15 kW	88 x 88	KG41B T104/12.VE
63 A	22 kW	88 x 88	KG64B T104/12.VE
80 A	30 kW	88 x 88	KG80 T104/12.VE
100 A	37 kW	88 x 88	KG100 T104/12.VE
125 A	45 kW	88 x 88	KG125 T104/12.VE
160 A	55 kW	88 x 88	KG160 T104/12.VE
200 A	75 kW	88 x 88	KG210 T104/13.VE
250 A	90 kW	88 x 88	KG250 T104/13.VE
315 A	110 kW	88 x 88	KG315 T104/13.VE
315 A	132 kW	88 x 88	C316 T104/13.VE

Unlock insert for door clutch M700/.

SID M700 29



Enables door opening in „On“ position and permanently defeating the interlock. (After inactivation the interlock it is mandatory to take effective precaution measures to prevent unauthorized person from opening the door.)

Drill hole pattern face plate

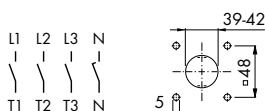

Drill hole pattern base (mounting on DIN rail up to KG100)

KG41B-KG100

KG125-C316

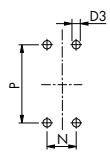
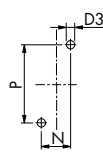

KG

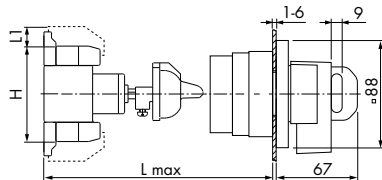
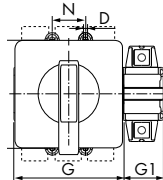

C316

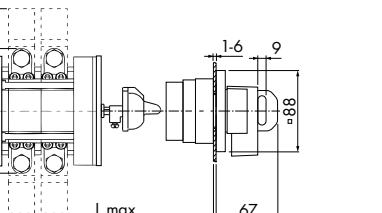
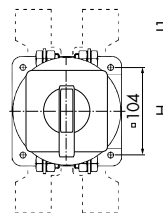

Maximum number of padlocks		
Face plate	Shackle-Ø	Number of padlocks
88 x 88	5	4
	8	3

	N	P	D3
KG41B, KG64B	25	70	4,1
KG80, KG100	25	90	5,2
KG125, KG160	36	120	6,4
KG210-KG315	44	142	6,4
C316	104	104	7

	G	G1	H	L	L1
KG41B	50	16	64	190	
KG64B	50	16	64	330	
KG80	70	22	80	380	
KG100	70	22	80	450	26
KG125, KG160	112	38	108	450	22,2
KG210-KG315	145	52,5	126	550	25
C316	128	-	150	550	46

Information about KG switches with bold terminals please see page 75.





JMobile®

The solution for Industry 4.0 – HMI, PLC and Gateway



- Multiple protocols
- OPC UA Server and Client
- CODESYS V3/V2 with Ethernet distributed I/O stacks.
- 3 Ethernet ports with different PHY
- High-resolution displays for multitouch operation
- Wide temperature range
- Expandable with local interfaces and IO's
- Robust design
- Web-Panel

KN-C 700 Wizard

Fast boot <10 sec.

Fanless

Ruggedized surface (resistant to scratches, UV, chemicals)

Fast writing to disc 50 MByte / sec.

FRAM 64 kByte

Real Time Clock

Long life cycle product

Low power consumption

Virtual Network Client and Server

Power supply 10 to 32 VDC

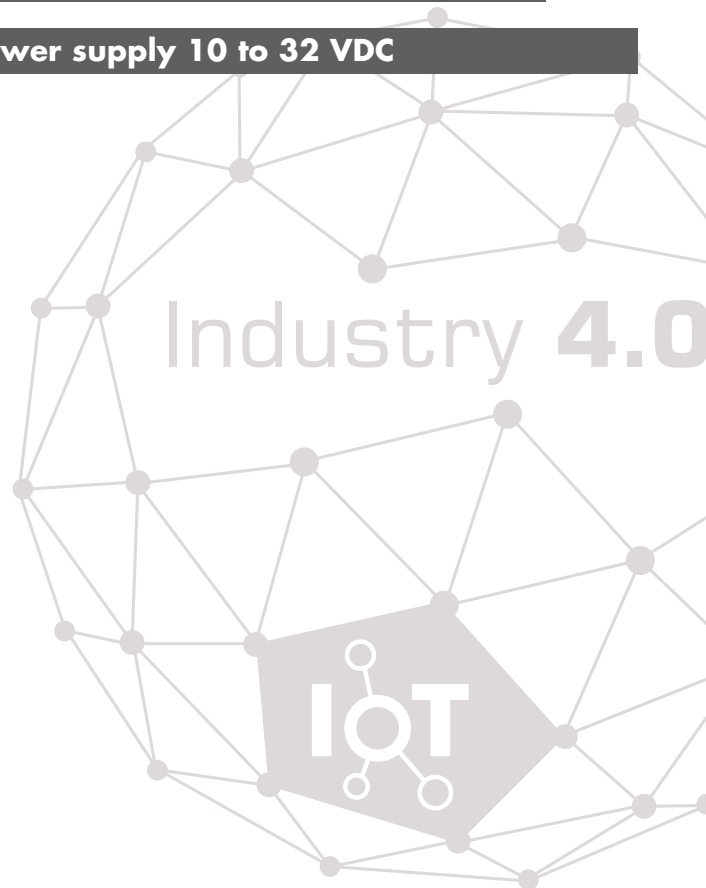



Plastic enclosures with high mechanical stability, high UV resistance and wide terminal compartment space

3-pole

Plastic enclosures



Rating AC-23B (A)	Thermal current (Iu/Ith)	Order number	Type of handle
3 x 400 V			
5,5 kW	20 A	KG10.T203/33.KS51V	
7,5 kW	25 A	KG20.T203/33.KL51V	
11 kW	32 A	KG32.T203/33.KL51V	
15 kW	40 A	KG41.T203/33.KL11V	
22 kW	63 A	KG64.T203/33.KL11V	
30 kW	80 A	KG80.T203/33.KL71V	
37 kW	100 A	KG100.T203/33.KL71V	
45 kW	125 A	KG125.T203/36.STM	
55 kW	160 A	KG160.T203/36.STM	
90 kW	250 A	KG250.T203/39.STM ¹	
110 kW	315 A	KG315.T203/39.STM ¹	
132 kW	315 A	C316.T203/39.STM ¹	

Similar image



Rating AC-23B (A)	Thermal current (Iu/Ith)	Order number	Type of handle
3 x 400 V			
5,5 kW	20 A	KG10.T103/33.KS51V	
7,5 kW	25 A	KG20.T103/33.KL51V	
11 kW	32 A	KG32.T103/33.KL51V	
15 kW	40 A	KG41.T103/33.KL11V	
22 kW	63 A	KG64.T103/33.KL11V	
30 kW	80 A	KG80.T103/33.KL71V	
37 kW	100 A	KG100.T103/33.KL71V	
45 kW	125 A	KG125.T103/36.STM	
55 kW	160 A	KG160.T103/36.STM	
90 kW	250 A	KG250.T103/39.STM ¹	
110 kW	315 A	KG315.T103/39.STM ¹	
132 kW	315 A	C316.T103/39.STM ¹	

Larger enclosures on request.
¹ switch enclosure with rubber sealed cable entry neck, additional cable fixing outside mandatory!



KS51V, KL51V, KL11V

KL71V

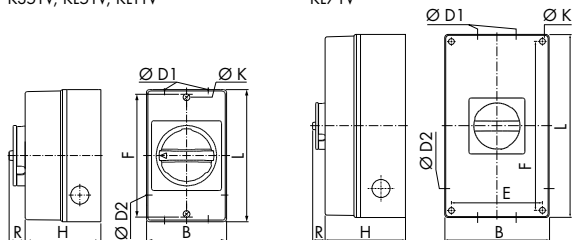

STM

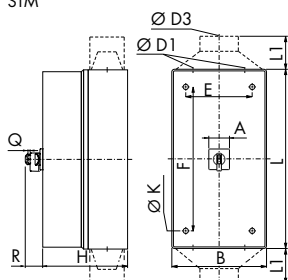

Maximum number of padlocks			
Padlock device	Face plate	Shackle-Ø	Number of padlocks
	74 x 74	9	3
	88 x 88	9	4
	130 x 130	9	4

	A	B	D1	D2	D3	E	F	H	K	L	L1	R	Q
KG10 ... KS51V	86	2 x 20/25	20			110	90	4,2	121		17		
KG20, KG32 ... KL51V	85	2 x 20/25	20			150	82	4,2	160		17		
KG41, KG64 ... KL11V	100	2 x 25	25			178	93	5,6	190		17		
KG80, KG100 ... KL71V	145	2 x 40/25	25			124	229	107	6,5	250	17		
KG125, KG160 ... STM	88	2 x 63 1 x 20				254	354	180	7,0	380	73	9	
KG250, KG315 ... STM	88	2 x 20			1 x 28-60 ²	254	534	180	7,0	560	110	73	9
C316 ... STM	130	280	2 x 20		1 x 28-60 ²	254	534	230	7,0	560	110	86,5	9,2

² Range of usable outside cable diameter



Plastic enclosures ▶ 3-pole + 1 NO/NC, IP 66 / 67

Plastic enclosures with high mechanical stability, high UV resistance and wide terminal compartment space



Similar image



Rating AC-23B (A)	Thermal current (Iu/Ith)	Order number	Type of handle
3 x 400 V	3-pole	2 Auxiliary contacts (1 NO, 1 NC)	
5,5 kW	20 A	KG10.T203/40.KS51V	
7,5 kW	25 A	KG20.T203/40.KL51V	
11 kW	32 A	KG32.T203/40.KL51V	
15 kW	40 A	KG41.T203/40.KL11V	
22 kW	63 A	KG64.T203/40.KL11V	
30 kW	80 A	KG80.T203/40.KL71V	
37 kW	100 A	KG100.T203/40.KL71V	
45 kW	125 A	KG125.T203/43.STM	
55 kW	160 A	KG160.T203/43.STM	
90 kW	250 A	KG250.T203/46.STM ¹	
110 kW	315 A	KG315.T203/46.STM ¹	
132 kW	315 A	C316.T203/46.STM ¹	

Rating AC-23B (A)	Thermal current (Iu/Ith)	Order number	Type of handle
3 x 400 V	3-pole	2 Auxiliary contacts (1 NO, 1 NC)	
5,5 kW	20 A	KG10.T103/40.KS51V	
7,5 kW	25 A	KG20.T103/40.KL51V	
11 kW	32 A	KG32.T103/40.KL51V	
15 kW	40 A	KG41.T103/40.KL11V	
22 kW	63 A	KG64.T103/40.KL11V	
30 kW	80 A	KG80.T103/40.KL71V	
37 kW	100 A	KG100.T103/40.KL71V	
45 kW	125 A	KG125.T103/43.STM	
55 kW	160 A	KG160.T103/43.STM	
90 kW	250 A	KG250.T103/46.STM ¹	
110 kW	315 A	KG315.T103/46.STM ¹	
132 kW	315 A	C316.T103/46.STM ¹	

Larger enclosures on request.
¹ switch enclosure with rubber sealed cable entry neck, additional cable fixing outside mandatory!

KG

C316

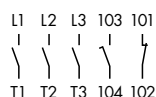
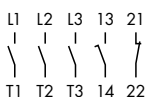

KS51V, KL51V, KL11V

KL71V

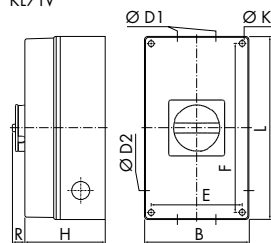
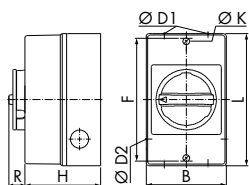

Maximum number of padlocks			
Padlock device	Face plate	Shackle-Ø	Number of padlocks
	74 x 74	9	3
	88 x 88	9	4
	130 x 130	9	4

STM

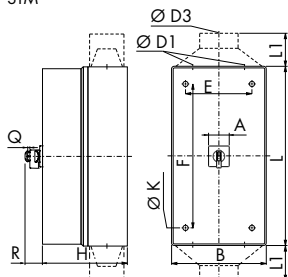

	A	B	D1	D2	D3	E	F	H	K	L	L1	R	Q
KG10 ... KS51V	86	2 x 20/25	20			110	90	4,2	121		17		
KG20, KG32 ... KL51V	85	2 x 20/25	20			150	82	4,2	160		17		
KG41, KG64 ... KL11V	100	2 x 25	25			178	93	5,6	190		17		
KG80, KG100 ... KL71V	145	2 x 40/25	25			124	229	107	6,5	250		17	
KG125, KG160 ... STM	88	280	2 x 63 1 x 20			254	354	180	7,0	380	73	9	
KG250, KG315 ... STM	88	280	2 x 20		1 x 286 ²	254	534	180	7,0	560	110	73	9
C316 ... STM	130	280	2 x 20		1 x 286 ²	254	534	230	7,0	560	110	86,5	9,2

² Range of usable outside cable diameter



Plastic enclosures with high mechanical stability, high UV resistance and wide terminal compartment space

4-pole

Plastic enclosures



Similar image



Rating AC-23B (A)	Thermal current (Iu/Ith)	Order number	Type of handle
3 x 400 V 4-pole			
5,5 kW	20 A	KG10.T204/33.KS51V	
7,5 kW	25 A	KG20.T204/33.KL51V	
11 kW	32 A	KG32.T204/33.KL51V	
15 kW	40 A	KG41.T204/33.KL11V	
22 kW	63 A	KG64.T204/33.KL11V	
30 kW	80 A	KG80.T204/33.KL71V	
37 kW	100 A	KG100.T204/33.KL71V	
45 kW	125 A	KG125.T204/36.STM	
55 kW	160 A	KG160.T204/36.STM	
90 kW	250 A	KG250.T204/47.STM ¹	
110 kW	315 A	KG315.T204/47.STM ¹	
132 kW	315 A	C316.T204/39.STM ¹	

Rating AC-23B (A)	Thermal current (Iu/Ith)	Order number	Type of handle
3 x 400 V 4-pole			
5,5 kW	20 A	KG10.T104/33.KS51V	
7,5 kW	25 A	KG20.T104/33.KL51V	
11 kW	32 A	KG32.T104/33.KL51V	
15 kW	40 A	KG41.T104/33.KL11V	
22 kW	63 A	KG64.T104/33.KL11V	
30 kW	80 A	KG80.T104/33.KL71V	
37 kW	100 A	KG100.T104/33.KL71V	
45 kW	125 A	KG125.T104/36.STM	
55 kW	160 A	KG160.T104/36.STM	
90 kW	250 A	KG250.T104/47.STM ¹	
110 kW	315 A	KG315.T104/47.STM ¹	
132 kW	315 A	C316.T104/39.STM ¹	

Larger enclosures on request.
¹ switch enclosure with rubber sealed cable entry neck, additional cable fixing outside mandatory!

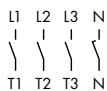

KS51V, KL51V, KL11V

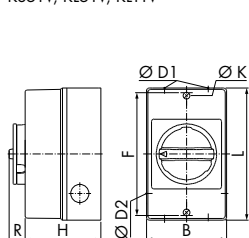

KL71V

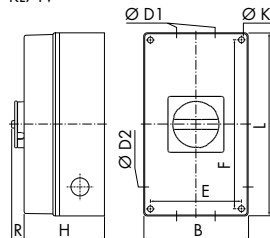

STM

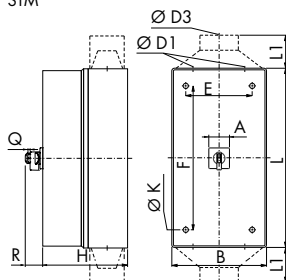

Maximum number of padlocks			
Padlock device	Face plate	Shackle-Ø	Number of padlocks
	74 x 74	9	3
	88 x 88	9	4
	130 x 130	9	4

	A	B	D1	D2	D3	E	F	H	K	L	L1	R	Q	
KG10 ... KS51V	86		2 x 20/25	20			110	90	4,2	121		17		
KG20, KG32 ... KL51V	85		2 x 20/25	20			150	82	4,2	160		17		
KG41, KG64 ... KL11V	100		2 x 25	25			178	93	5,6	190		17		
KG80, KG100 ... KL71V	145		2 x 40/25	25			124	229	107	6,5	250	17		
KG125, KG160 ... STM	88	280	2 x 63 1 x 20				254	354	180	7,0	380	73	9	
KG250, KG315 ... STM	88	280	2 x 20		1 x 28-60 ²		254	534	180	7,0	560	110	73	9
C316 ... STM	130	280	2 x 20		1 x 28-60 ²		254	534	230	7,0	560	110	86,5	9,2

² Range of usable outside cable diameter



Plastic enclosures ▶ 4-pole + 1 NO/NC, IP 66 / 67

Plastic enclosures with high mechanical stability, high UV resistance and wide terminal compartment space



Similar image



Rating AC-23B (A)	Thermal current (Iu/Ith)	Order number	Type of handle
3 x 400 V	4-pole	2 Auxiliary contacts (1 NO, 1 NC)	
5,5 kW	20 A	KG10.T204/40.KS51V	
7,5 kW	25 A	KG20.T204/40.KL51V	
11 kW	32 A	KG32.T204/40.KL51V	
15 kW	40 A	KG41.T204/40.KL11V	
22 kW	63 A	KG64.T204/40.KL11V	
30 kW	80 A	KG80.T204/40.KL71V	
37 kW	100 A	KG100.T204/40.KL71V	
45 kW	125 A	KG125.T204/43.STM	
55 kW	160 A	KG160.T204/43.STM	
90 kW	250 A	KG250.T204/48.STM ¹	
110 kW	315 A	KG315.T204/48.STM ¹	
132 kW	315 A	C316.T204/46.STM ¹	

Rating AC-23B (A)	Thermal current (Iu/Ith)	Order number	Type of handle
3 x 400 V	4-pole	2 Auxiliary contacts (1 NO, 1 NC)	
5,5 kW	20 A	KG10.T104/40.KS51V	
7,5 kW	25 A	KG20.T104/40.KL51V	
11 kW	32 A	KG32.T104/40.KL51V	
15 kW	40 A	KG41.T104/40.KL11V	
22 kW	63 A	KG64.T104/40.KL11V	
30 kW	80 A	KG80.T104/40.KL71V	
37 kW	100 A	KG100.T104/40.KL71V	
45 kW	125 A	KG125.T104/43.STM	
55 kW	160 A	KG160.T104/43.STM	
90 kW	250 A	KG250.T104/48.STM ¹	
110 kW	315 A	KG315.T104/48.STM ¹	
132 kW	315 A	C316.T104/46.STM ¹	

Larger enclosures on request.
¹ switch enclosure with rubber sealed cable entry neck, additional cable fixing outside mandatory!

KG

C316

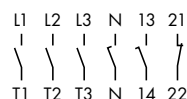

KS51V, KL51V, KL11V

KL71V

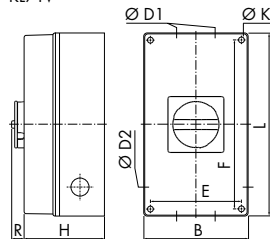
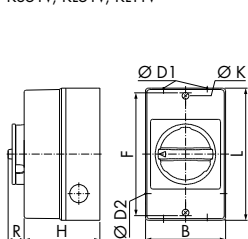

Maximum number of padlocks			
Padlock device	Face plate	Shackle-Ø	Number of padlocks
	74 x 74	9	3
	88 x 88	9	4
	130 x 130	9	4

STM

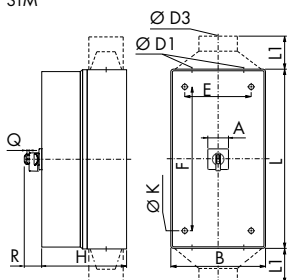

	A	B	D1	D2	D3	E	F	H	K	L	L1	R	Q
KG10 ... KS51V	86	2 x 20/25	20			110	90	4,2	121		17		
KG20, KG32 ... KL51V	85	2 x 20/25	20			150	82	4,2	160		17		
KG41, KG64 ... KL11V	100	2 x 25	25			178	93	5,6	190		17		
KG80, KG100 ... KL71V	145	2 x 40/25	25			124	229	107	6,5	250		17	
KG125, KG160 ... STM	88	280	2 x 63 1 x 20			254	354	180	7,0	380		73	9
KG250, KG315 ... STM	88	280	2 x 20		1 x 28-60 ²	254	534	180	7,0	560	110	73	9
C316 ... STM	130	280	2 x 20		1 x 28-60 ²	254	534	230	7,0	560	110	86,5	9,2

² Range of usable outside cable diameter

MAIN, SAFETY AND MAINTENANCE SWITCH

Plastic enclosures ▶ 6-pole, IP 66 / 67



Plastic enclosures with high mechanical stability, high UV resistance and wide terminal compartment space



6-pole



Rating AC-23B (A)	Thermal current (Iu/Ith)	Order number	Type of handle
3 x 400 V	6-pole		
5,5 kW	20 A	KG10.T206/33.KS51V	
7,5 kW	25 A	KG20B.T206/33.KL11V	
11 kW	32 A	KG32B.T206/33.KL11V	
15 kW	40 A	KG41B.T206/33.KL71V	
22 kW	63 A	KG64B.T206/33.KL71V	
30 kW	80 A	KG80C.T206/34.STM ¹	
37 kW	100 A	KG100C.T206/34.STM ¹	
45 kW	125 A	KG125.T206/87.STM ¹	
55 kW	160 A	KG160.T206/87.STM ¹	
132 kW	275A	C316.T206/47.STM ²	

Similar image



Rating AC-23B (A)	Thermal current (Iu/Ith)	Order number	Type of handle
3 x 400 V	6-pole		
5,5 kW	20 A	KG10.T106/33.KS51V	
7,5 kW	25 A	KG20B.T106/33.KL11V	
11 kW	32 A	KG32B.T106/33.KL11V	
15 kW	40 A	KG41B.T106/33.KL71V	
22 kW	63 A	KG64B.T106/33.KL71V	
30 kW	80 A	KG80C.T106/34.STM ¹	
37 kW	100 A	KG100C.T106/34.STM ¹	
45 kW	125 A	KG125.T106/87.STM ¹	
55 kW	160 A	KG160.T106/87.STM ¹	
132 kW	275A	C316.T106/47.STM ²	

¹ Protection IP 65 | ² switch enclosure with rubber sealed cable entry neck. Larger enclosures on request. additional cable fixing outside mandatory!

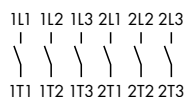

KS51V, KL11V

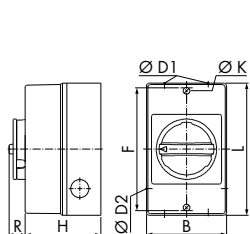

KL71V

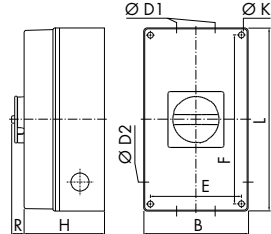

STM

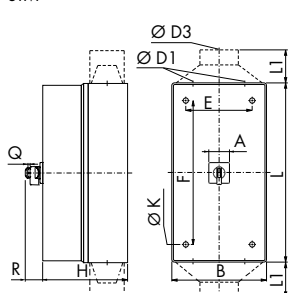

Mounting Kit ST7 M100 P (KG80C – KG160 incl.)

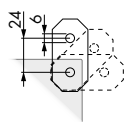

Maximum number of padlocks			
Padlock device	Face plate	Shackle-Ø	Number of padlocks
	74 x 74	9	3
	88 x 88	9	4
	130 x 130	9	4

	A	B	D1	D2	D3	E	F	H	K	L	L1	R	Q
KG10 ... KS51V	86		2 x 20/25	20		110	90	4,2	121		17		
KG20B, KG32B ... KL11V	100		2 x 25	25		178	93	5,6	190		17		
KG41B, KG64B ... KL71V	145		2 x 40/25	25		124	229	107	6,5	250	17		
KG80C, KG100C ... STM	88	200	2 x 40/50 3 x 20			172	272	172		300	49,3		
KG125, KG160 ... STM	88	300	2 x 63 1 x 20			272	372	172		400	73	9	
C316 ... STM	130	380	2 x 20		2 x 28-60 ³	354	534	280	7	560	110	86,5	9,2

³ Range of usable outside cable diameter



Plastic enclosures ▶ 6-pole + 1 NO/NC, IP 66 / 67

Plastic enclosures with high mechanical stability, high UV resistance and wide terminal compartment space



Similar image

Rating AC-23B (A)	Thermal current (Iu/Ith)	Order number	Type of handle
3 x 400 V	6-pole	2 Auxiliary contacts (1 NO, 1 NC)	
5,5 kW	20 A	KG10.T206/40.KS51V	
7,5 kW	25 A	KG20B.T206/40.KL11V	
11 kW	32 A	KG32B.T206/40.KL11V	
15 kW	40 A	KG41B.T206/40.KL71V	
22 kW	63 A	KG64B.T206/40.KL71V	
30 kW	80 A	KG80C.T206/41.STM ¹	
37 kW	100 A	KG100C.T206/41.STM ¹	
45 kW	125 A	KG125.T206/91.STM ¹	
55 kW	160 A	KG160.T206/91.STM ¹	
132 kW	275 A	C316.T206/48.STM ²	



Rating AC-23B (A)	Thermal current (Iu/Ith)	Order number	Type of handle
3 x 400 V	6-pole	2 Auxiliary contacts (1 NO, 1 NC)	
5,5 kW	20 A	KG10.T106/40.KS51V	
7,5 kW	25 A	KG20B.T106/40.KL11V	
11 kW	32 A	KG32B.T106/40.KL11V	
15 kW	40 A	KG41B.T106/40.KL71V	
22 kW	63 A	KG64B.T106/40.KL71V	
30 kW	80 A	KG80C.T106/41.STM ¹	
37 kW	100 A	KG100C.T106/41.STM ¹	
45 kW	125 A	KG125.T106/91.STM ¹	
55 kW	160 A	KG160.T106/91.STM ¹	
132 kW	275 A	C316.T106/48.STM ²	

¹ Protection IP 65 | ² switch enclosure with rubber sealed cable entry neck. Larger enclosures on request. additional cable fixing outside mandatory!

KG

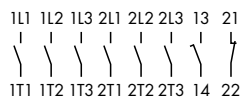

C316

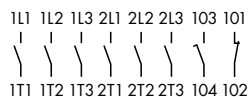

KS51V, KL11V

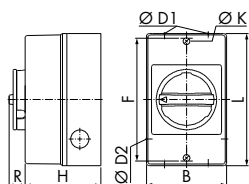

KL71V

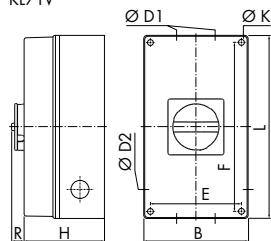

Maximum number of padlocks			
Padlock device	Face plate	Shackle-Ø	Number of padlocks
	74 x 74	9	3
	88 x 88	9	4
	130 x 130	9	4

STM

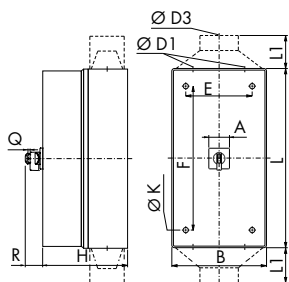

Mounting kit ST7 M100 P (KG80C – KG160 incl.)

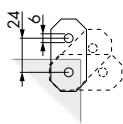

	A	B	D1	D2	D3	E	F	H	K	L	L1	R	Q
KG10 ... KS51V	86	2 x 20/25	20			110	90	4,2	121		17		
KG20B, KG32B ... KL11V	100	2 x 25	25			178	93	5,6	190		17		
KG41B, KG64B ... KL71V	145	2 x 40/25	25			124	229	107	6,5	250		17	
KG80C, KG100C ... STM	88	200	2 x 40/50 3 x 20			172	272	172		300		49,3	
KG125, KG160 ... STM	88	300	2 x 63 1 x 20			272	372	172		400		73	9
C316 ... STM	130	380	2 x 20		2 x 28-60 ³	354	534	280	7	560	110	86,5	9,2

³ Range of usable outside cable diameter

MAIN, SAFETY AND MAINTENANCE SWITCH

For EMC-compliant connection ▶ 3-pole + 1 NO/NC, IP 66 / 67

EMC

Plastic enclosures with high mechanical stability, high UV resistance and wide terminal compartment space

3-pole + 1NO/NC

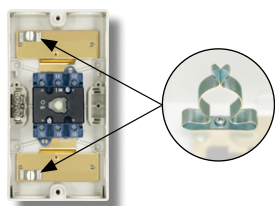

KS/KL

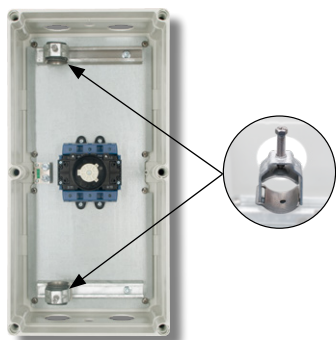

STM

Similar image

Notice: The outside-Ø is bigger for shielded cables

with Auxiliary contacts (1 NO + 1 NC)

Gland	Rating AC-23B (A)	Order number	Type of handle
	3 x 400 V		
M25	5,5 kW	KG10.T203/D-A076.KS51V	
M25	7,5 kW	KG20.T203/D-A159.KL51V	
M25	11 kW	KG32.T203/D-A117.KL51V	
M25	15 kW	KG41.T203/D-A145.KL11V	
M25	22 kW	KG64.T203/D-A173.KL11V	
M40	30 kW	KG80.T203/D-A108.KL71V	
M40	37 kW	KG100.T203/D-A120.KL71V	
M63	45 kW	KG125.T203/D-A082.STM	
M63	55 kW	KG160.T203/D-A077.STM	
M63	90 kW	KG250.T203/D-A075.STM	
28-60 mm	110 kW	KG315.T203/D-A034.STM ¹	
M72	132 kW	C316.T203/D-A037.STM	

¹ Switch enclosure with rubber sealed cable entry neck. additional cable fixing outside mandatory!

Notice:

Maintenance switches designed for EMC compliant connecting of variable speed drives are equipped with shield brackets (KS- and KL- enclosures) or clamps mounted on rail (STM enclosure). Enabling a large scale uninterrupted transmission of the shield.

KG

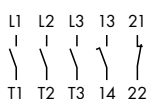

C316

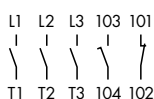

Cable-Ø shield

	KG10	9 – 11
	KG20 – KG64	12 – 16
	KG80/KG100	23 – 29
	KG125 – KG250	34 – 40
	KG315/C316	46 – 52

KS51V, KL51V, KL11V

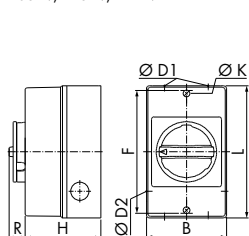

KL71V

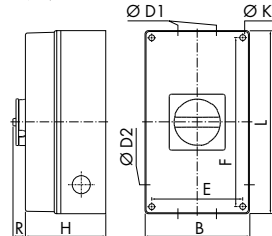

STM

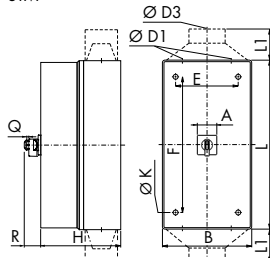

Maximum number of padlocks

Padlock device	Face plate	Shackle-Ø	Number of padlocks
	74 x 74	9	3
	88 x 88	9	4
	130 x 130	9	4

	A	B	D1	D2 D3	E	F	H	K	L	L1	R	Q
KG10 ... KS51V	86	2 x 20/25	20		110	90	4,2	121	17			
KG20, KG32 ... KL51V	85	2 x 20/25	20		150	82	4,2	160	17			
KG41, KG64 ... KL11V	100	2 x 25	25		178	93	5,6	190	17			
KG80, KG100 ... KL71V	145	2 x 40/25	25		124	229	107	6,5	250	17		
KG125, KG160, KG250 ... STM	88	280	2 x 63 1 x 20		254	534	180	7	560	73	9	
KG315 ... STM	88	280	2 x 20	1 x 28-60 ²	254	534	180	7	560	110	73	9
C316 ... STM	130	380	2 x 72 1 x 20		354	534	280	7	560	86,5	9,2	

² Range of usable outside cable diameter

Plastic enclosures EMC-compliant



For EMC-compliant connection ▶ 3-pole + 1 NO/NC, IP 66 / 67

Plastic enclosures with high mechanical stability, high UV resistance and wide terminal compartment space

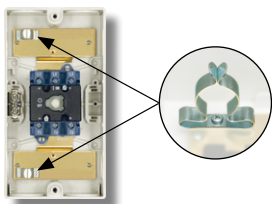

KS/KL

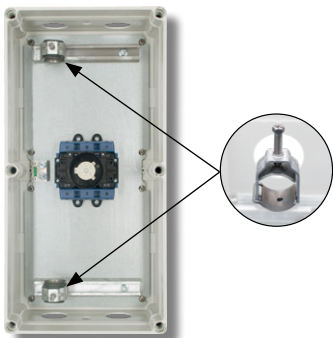

STM

Similar image

Notice: The outside-Ø is bigger for shielded cables

with Auxiliary contacts (1 NO + 1 NC)

Gland	Rating AC-23B (A)	Order number	Type of handle
	3 x 400 V		
M25	5,5 kW	KG10.T103/D-A050.KS51V	KS/KL
M25	7,5 kW	KG20.T103/D-A126.KL51V	
M25	11 kW	KG32.T103/D-A061.KL51V	KS/KL
M25	15 kW	KG41.T103/D-A087.KL11V	
M25	22 kW	KG64.T103/D-A103.KL11V	KS/KL
M40	30 kW	KG80.T103/D-A061.KL71V	
M40	37 kW	KG100.T103/D-A068.KL71V	STM
M63	45 kW	KG125.T103/D-A070.STM	
M63	55 kW	KG160.T103/D-A066.STM	STM
M63	90 kW	KG250.T103/D-A073.STM	
28-60 mm	110 kW	KG315.T103/D-A043.STM ¹	STM
M72	132 kW	C316.T103/D-A025.STM	

¹ Switch enclosure with rubber sealed cable entry neck. additional cable fixing outside mandatory!

Notice:

Maintenance switches designed for EMC compliant connecting of variable speed drives are equipped with shield brackets (KS- and KL-enclosures) or clamps mounted on rail (STM enclosure). Enabling a large scale uninterrupted transmission of the shield.

KG

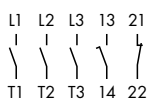

C316

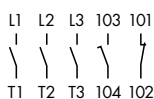

Cable-Ø shield	Order number	Range
	KG10	9 – 11
	KG20 – KG64	12 – 16
	KG80/KG100	23 – 29
	KG125 – KG250	34 – 40
	KG315/C316	46 – 52

KS51V, KL51V, KL11V

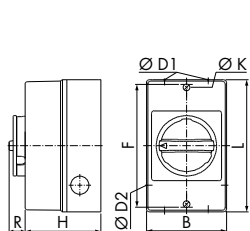

KL71V

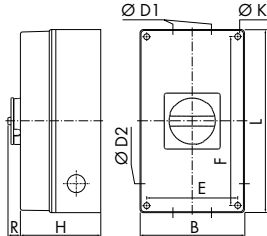

STM

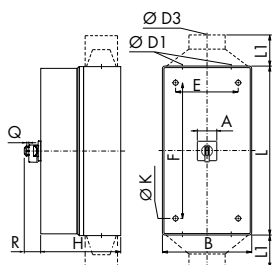

Mounting kit ST6.A000.G

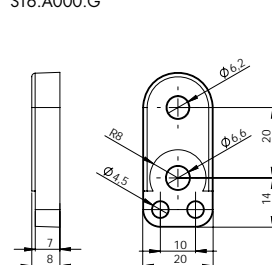

Padlock device	Face plate	Shackle-Ø	Number of padlocks
	74 x 74	9	3
	88 x 88	9	4
	130 x 130	9	4

	A	B	D1	D2	D3	E	F	H	K	L	L1	R	Q
KG10 ... KS51V	86		2 x 20/25	20		110	90	4,2	121		17		
KG20, KG32 ... KL51V	85		2 x 20/25	20		150	82	4,2	160		17		
KG41, KG64 ... KL11V	100		2 x 25	25		178	93	5,6	190		17		
KG80, KG100 ... KL71V	145		2 x 40/25	25		124	229	107	6,5	250		17	
KG125, KG160, KG250 ... STM	88	280	2 x 63 1 x 20			254	534	180	7	560	73	9	
KG315 ... STM	88	280	2 x 20		1 x 28-60 ²	254	534	180	7	560	110	73	9
C316 ... STM	130	380	2 x 72 1 x 20			354	534	280	7	560		86,5	9,2

² Range of usable outside cable diameter



3-pole + 1NO/NC

Plastic enclosures EMC-compliant

MAIN, SAFETY AND MAINTENANCE SWITCH

For EMC-compliant connection ▶ 4-pole + 1 NO/NC, IP 66 / 67

EMC

Plastic enclosures with high mechanical stability, high UV resistance and wide terminal compartment space

4-pole + 1NO/NC

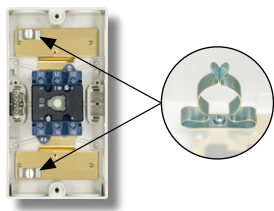

KS/KL

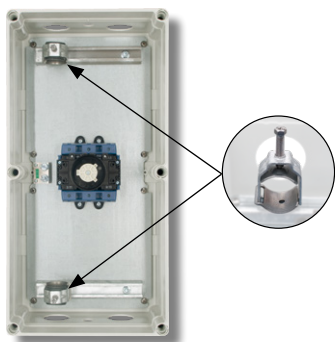

STM

Similar image

Notice: The outside-Ø is bigger for shielded cables

with Auxiliary contacts (1 NO + 1 NC)

Gland	Rating AC-23B (A)	Order number	Type of handle
	3 x 400 V		
M25	5,5 kW	KG10.T204/D-A020.KS51V	
M25	7,5 kW	KG20.T204/D-A044.KL51V	
M25	11 kW	KG32.T204/D-A026.KL51V	
M25	15 kW	KG41.T204/D-A035.KL11V	
M25	22 kW	KG64.T204/D-A087.KL11V	
M40	30 kW	KG80.T204/D-W006.KL71V	
M40	37 kW	KG100.T204/D-A063.KL71V	
M63	45 kW	KG125.T204/D-A022.STM	
M63	55 kW	On request	
M63	90 kW	KG250.T204/D-A024.STM	
28-60 mm	110 kW	On request	
M72	132 kW	On request	

¹ Switch enclosure with rubber sealed cable entry neck. additional cable fixing outside mandatory!

Notice:

Maintenance switches designed for EMC compliant connecting of variable speed drives are equipped with shield brackets (KS- and KL-enclosures) or clamps mounted on rail (STM enclosure). Enabling a large scale uninterrupted transmission of the shield.

Plastic enclosures EMC-compliant

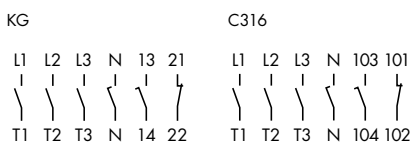



KS51V, KL51V, KL11V

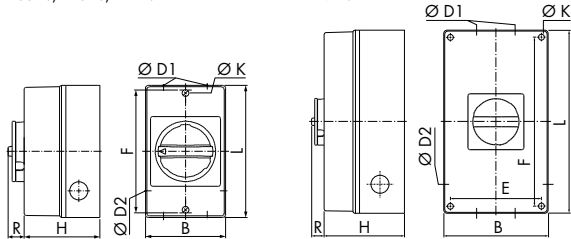

KL71V

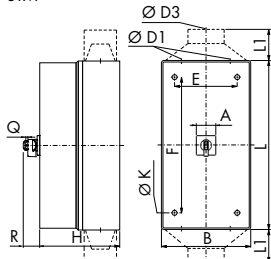

STM



Cable-Ø shield	Order number	Range
	KG10	9 – 11
	KG20 – KG64	12 – 16
	KG80/KG100	23 – 29
	KG125 – KG250	34 – 40
	KG315/C316	46 – 52

Maximum number of padlocks			
Padlock device	Face plate	Shackle-Ø	Number of padlocks
	74 x 74	9	3
	88 x 88	9	4
	130 x 130	9	4

	A	B	D1	D2: D3	E	F	H	K	L	L1	R	Q
KG10 ... KS51V	86		2 x 20/25	20		110	90	4,2	121		17	
KG20, KG32 ... KL51V	85		2 x 20/25	20		150	82	4,2	160		17	
KG41, KG64 ... KL11V	100		2 x 25	25		178	93	5,6	190		17	
KG80, KG100 ... KL71V	145		2 x 40/25	25	124	229	107	6,5	250		17	
KG125, KG160, KG250 ... STM	88	280	2 x 63 1 x 20		254	534	180	7	560	73	9	
KG315 ... STM	88	280	2 x 20	1 x 28-60 ²	254	534	180	7	560	110	73	9
C316 ... STM	130	380	2 x 72 1 x 20		354	534	280	7	560		86,5	9,2

² Range of usable outside cable diameter



For EMC-compliant connection ▶ 4-pole + 1 NO/NC, IP 66 / 67

Plastic enclosures with high mechanical stability, high UV resistance and wide terminal compartment space

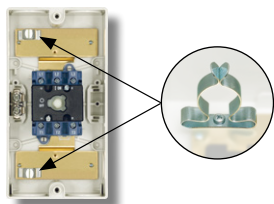

KS/KL

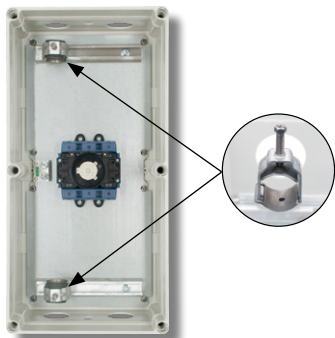

STM

Similar image

Notice: The outside-Ø is bigger for shielded cables

with Auxiliary contacts (1 NO + 1 NC)

Gland	Rating AC-23B (A)	Order number	Type of handle
	3 x 400 V		
M25	5,5 kW	KG10.T104/D-A008.KS51V	KS/KL
M25	7,5 kW	KG20.T104/D-A021.KL51V	
M25	11 kW	KG32.T104/D-A022.KL51V	KS/KL
M25	15 kW	KG41.T104/D-A023.KL11V	
M25	22 kW	KG64.T104/D-A060.KL11V	KS/KL
M40	30 kW	KG80.T104/D-A036.KL71V	
M40	37 kW	KG100.T104/D-A043.KL71V	STM
M63	45 kW	KG125.T104/D-A021.STM	
M63	55 kW	On request	STM
M63	90 kW	KG250.T104/D-A026.STM	
28-60 mm ¹	110 kW	On request	STM
M72	132 kW	On request	

¹ Switch enclosure with rubber sealed cable entry neck. additional cable fixing outside mandatory!

Notice:

Maintenance switches designed for EMC compliant connecting of variable speed drives are equipped with shield brackets (KS- and KL-enclosures) or clamps mounted on rail (STM enclosure). Enabling a large scale uninterrupted transmission of the shield.

KG

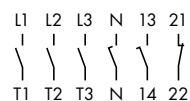

C316

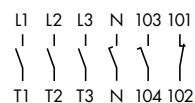

KS51V, KL51V, KL11V

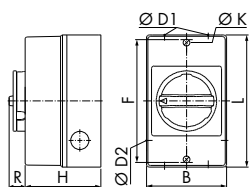

KL71V

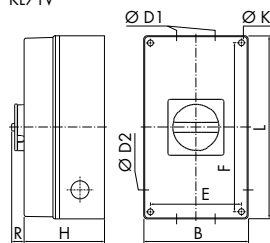

STM

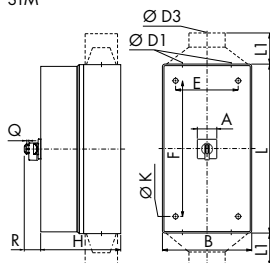

Cable-Ø shield

	KG10	9 – 11
	KG20 – KG64	12 – 16
	KG80/KG100	23 – 29
	KG125 – KG250	34 – 40
	KG315/C316	46 – 52

Maximum number of padlocks

Padlock device	Face plate	Shackle-Ø	Number of padlocks
	74 x 74	9	3
	88 x 88	9	4
	130 x 130	9	4

	A	B	D1	D2	D3	E	F	H	K	L	L1	R	Q
KG10 ... KS51V	86	2 x 20/25	20			110	90	4,2	121	17			
KG20, KG32 ... KL51V	85	2 x 20/25	20			150	82	4,2	160	17			
KG41, KG64 ... KL11V	100	2 x 25	25			178	93	5,6	190	17			
KG80, KG100 ... KL71V	145	2 x 40/25	25			124	229	107	6,5	250	17		
KG125, KG160, KG250 ... STM	88	280	2 x 63 1 x 20			254	534	180	7	560	73	9	
KG315 ... STM	88	280	2 x 20	1 x 28-60 ²		254	534	180	7	560	110	73	9
C316 ... STM	130	380	2 x 72 1 x 20			354	534	280	7	560	86,5	9,2	

² Range of usable outside cable diameter



MAIN, SAFETY AND MAINTENANCE SWITCH

For EMC-compliant connection ▶ 6-pole + 1 NO/NC, IP 66 / 67

EMC

Plastic enclosures with high mechanical stability, high UV resistance and wide terminal compartment space

6-pole
+ 1NO/NC

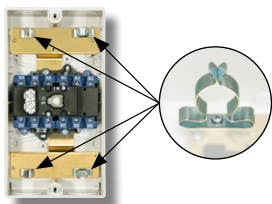

KL

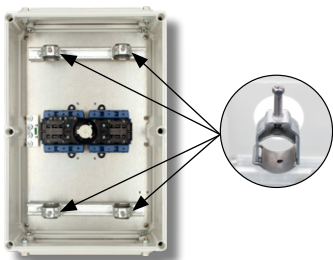

STM

Similar image

Notice: The outside-Ø is bigger for shielded cables

with Auxiliary contacts (1 NO + 1 NC)

Gland	Rating AC-23B (A)	Order number	Type of handle
	3 x 400 V		
M25	7,5 kW	KG20B.T206/D-A059.KL11V	
M25	11 kW	KG32B.T206/D-A054.KL11V	
M40	15 kW	KG41B.T206/D-A052.KL71V	
M40	22 kW	KG64B.T206/D-A066.KL71V	
M50	30 kW	KG80C.T206/D-A070.STM	
M50	37 kW	KG100C.T206/D-A060.STM	
M63	45 kW	KG125.T206/D-A020.STM	
M63	55 kW	KG160.T206/D-A040.STM	
M63	75 kW	C200-4.T206/D-A001.STM	
M72	132 kW	C316.T206/D-A050.STM	

Notice:

Maintenance switches designed for EMC compliant connecting of variable speed drives are equipped with shield brackets (KS- and KL-enclosures) or clamps mounted on rail (STM enclosure). Enabling a large scale uninterrupted transmission of the shield.

KG

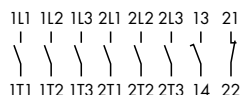

C200-4/C316

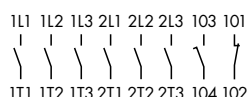

Cable-Ø shield

	KG20B/KG32B	12 – 16
	KG41B/KG64B	23 – 29
	KG80C/KG100C	28 – 34
	KG125/KG160/C200-4	34 – 40
	C316	46 – 52

KL11V

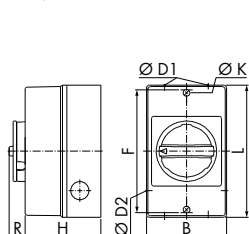

KL71V

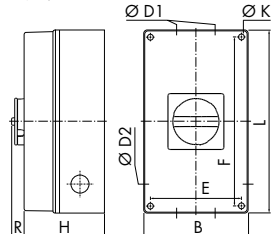

STM

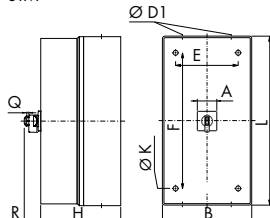

Maximum number of padlocks

Padlock device	Face plate	Shackle-Ø	Number of padlocks
	74 x 74	9	3
	88 x 88	10	3
	88 x 88	9	4
	130 x 130	9	4

	A	B	D1	D2	E	F	H	K	L	R	Q
KG20B, KG32B ... KL11V		100	2 x 25	25		178	93	5,6	190	17	
KG41B, KG64B ... KL71V		145	2 x 40/25	25	124	229	107	6,5	250	17	
KG80C, KG100C ... STM	88	280	2 x 50 1 x 20		254	354	180	7	380	49,3	10
KG125, KG160 ... STM	88	380	2 x 63 1 x 20		354	534	180	7	560	73	9
C200-4 ... STM	88	380	2 x 63 1 x 20		354	534	230	7	560	73	9
C316 ... STM	130	380	2 x 72 1 x 20		354	534	280	7	560	86,5	9,2

Plastic enclosures EMC-compliant



For EMC-compliant connection ▶ 6-pole + 1 NO/NC, IP 66 / 67

Plastic enclosures with high mechanical stability, high UV resistance and wide terminal compartment space

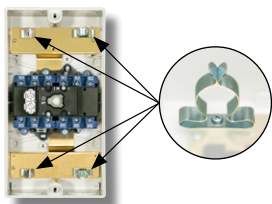

KL

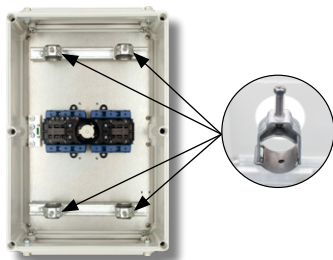

STM

Similar image

Notice: The outside-Ø is bigger for shielded cables

with Auxiliary contacts (1 NO + 1 NC)

Gland	Rating AC-23B (A)	Order number	Type of handle
	3 x 400 V		
M25	7,5 kW	KG20B.T106/D-A046.KL11V	
M25	11 kW	KG32B.T106/D-A040.KL11V	
M40	15 kW	KG41B.T106/D-A032.KL71V	
M40	22 kW	KG64B.T106/D-A038.KL71V	
M50	30 kW	KG80C.T106/D-A055.STM	
M50	37 kW	KG100C.T106/D-A049.STM	
M63	45 kW	KG125.T106/D-A031.STM	
M63	55 kW	KG160.T106/D-A024.STM	
M63	75 kW	C200-4.T106/D-A001.STM	
M72	132 kW	C316.T106/D-A033.STM	

Notice:

Maintenance switches designed for EMC compliant connecting of variable speed drives are equipped with shield brackets (KS- and KL-enclosures) or clamps mounted on rail (STM enclosure). Enabling a large scale uninterrupted transmission of the shield.

KG

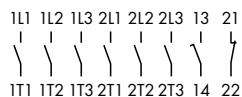

C200-4/C316

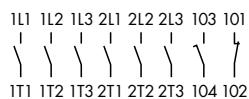

Cable-Ø shield	Order number	Number of padlocks
	KG20B/KG32B	12 – 16
	KG41B/KG64B	23 – 29
	KG80C/KG100C	28 – 34
	KG125/KG160/C200-4	34 – 40
	C316	46 – 52

KL11V

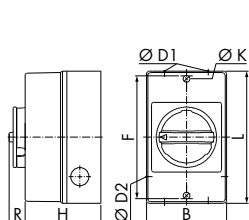

KL71V

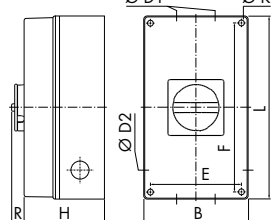

STM

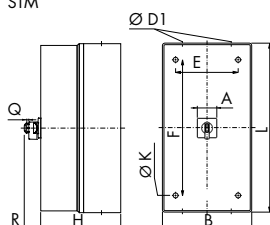

Maximum number of padlocks			
Padlock device	Face plate	Shackle-Ø	Number of padlocks
	74 x 74	9	3
	88 x 88	10	3
	88 x 88	9	4
	130 x 130	9	4

	A	B	D1	D2	E	F	H	K	L	R	Q
KG20B, KG32B ... KL11V		100	2 x 25	25		178	93	5,6	190	17	
KG41B, KG64B ... KL71V		145	2 x 40/25	25	124	229	107	6,5	250	17	
KG80C, KG100C ... STM	88	280	2 x 50 1 x 20		254	354	180	7	380	49,3	10
KG125, KG160 ... STM	88	380	2 x 63 1 x 20		354	534	180	7	560	73	9
C200-4 ... STM	88	380	2 x 63 1 x 20		354	534	230	7	560	73	9
C316 ... STM	130	380	2 x 72 1 x 20		354	534	280	7	560	86,5	9,2

SAFETY SWITCH ACC. TO DIN EN 62626-1 CLASS 0

Plastic enclosure ▶ 3-pole + 1 NO/NC, IP 66 / 67



Plastic enclosures with high mechanical stability, high UV resistance and wide terminal compartment space

3-pole
+ 1NO/NC

Safety switch



Similar image



Rating AC-23B (A)	Thermal current (I _v /I _{th})	Order number	Type of handle
3 x 400 V	3-pole	2 Auxiliary contacts (1 NO, 1 NC)	
5,5 kW	20 A	KG10.T203/WASIO2.KL52V	
7,5 kW	25 A	KG20.T203/WASIO2.KL12V	
11 kW	32 A	KG32.T203/WASIO2.KL12V	
15 kW	40 A	KG41.T203/WASIO2.KL12V	
22 kW	63 A	KG64.T203/WASIO2.KL12V	
30 kW	80 A	KG80.T203/WASIO2.KL72V	
37 kW	100 A	KG100.T203/WASIO2.KL72V	
45 kW	125 A	KG125.T203/WASIO2.STM	
55 kW	160 A	KG160.T203/WASIO2.STM	
90 kW	250 A	KG250.T203/WASIO2.STM	
110 kW	315 A	KG315.T203/WASIO2.STM	

Rating AC-23B (A)	Thermal current (I _v /I _{th})	Order number	Type of handle
3 x 400 V	3-pole	2 Auxiliary contacts (1 NO, 1 NC)	
5,5 kW	20 A	KG10.T103/WASIO2.KL52V	
7,5 kW	25 A	KG20.T103/WASIO2.KL12V	
11 kW	32 A	KG32.T103/WASIO2.KL12V	
15 kW	40 A	KG41.T103/WASIO2.KL12V	
22 kW	63 A	KG64.T103/WASIO2.KL12V	
30 kW	80 A	KG80.T103/WASIO2.KL72V	
37 kW	100 A	KG100.T103/WASIO2.KL72V	
45 kW	125 A	KG125.T103/WASIO2.STM	
55 kW	160 A	KG160.T103/WASIO2.STM	
90 kW	250 A	KG250.T103/WASIO2.STM	
110 kW	315 A	KG315.T103/WASIO2.STM	

Notice:

The safety switches according to DIN EN 62626-1 Class 0 are equipped with a cover interlock which allows the cover to be removed in position "I" only. The basic requirements of these devices are derived from switch disconnectors in accordance with IEC 60947-3. Furthermore, our safety switches according to DIN EN 62626-1 Class 0 have the following characteristics:

- IK06 impact resistance according to IEC 62262
- Ingress protection rating of IP66/67 according to IEC60529
- AC-23A switching capacity according to IEC60947-3
- Cover interlock, to prevent the opening of the enclosure in "OFF" position
- 3 times lockable in OFF position
- Moisture heat, salt mist and vibration test, category A according to IEC60947-1 Annex Q

KG

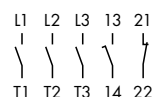

KL51V, KL11V, KL71V

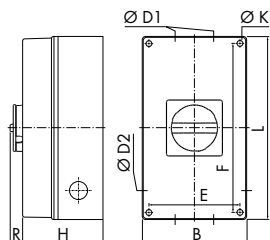

STM

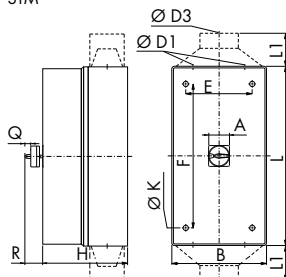

Maximum number of padlocks			
Padlock device	Face plate	Shackle-Ø	Number of padlocks
	74 x 74	9	3
	88 x 88	10	3

	A	B	D1	D2 D3	E	F	H	K	L	L1	R	Q
KG10 ... KL52V	85	2 x 20/25	20		150	82	4,2	160	17			
KG20, KG32 ... KL12V	85	2 x 20/25	20		150	82	4,2	160	17			
KG41, KG64 ... KL12V	100	2 x 25	25		124	178	9,3	5,6	190	17		
KG80, KG100 ... KL72V	145	2 x 25/40	25		254	229	10,7	6,5	250	17		
KG125, KG160 ... STM	88	280	2 x 63 1 x 20		254	354	180	7,0	380	49	9	
KG250, KG315 ... STM	88	280	2 x 20/25	1 x 28-60 ²	534	180	7,0	560	110	49	9	

² Range of usable outside cable diameter



For EMC-compliant connection ▶ 3-pole + 1 NO/NC, IP 66 / 67

Plastic enclosures with high mechanical stability, high UV resistance and wide terminal compartment space

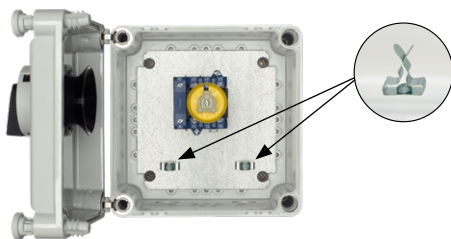

Similar image

KG

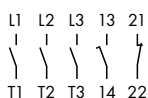

STM

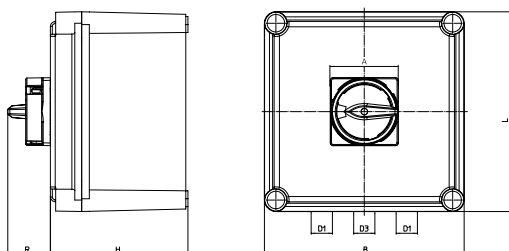

Cable-Ø shield		
	KG20 – KG64	12 – 16
	KG80/KG100	23 – 29
	KG125 – KG250	34 – 40
	KG315	46

Notice: The outside-Ø is bigger for shielded cables

with Auxiliary contacts (1 NO + 1 NC)

Gland	Rating AC-23B (A)	Thermal current (I _v /I _{th})	Order number	Type of handle
	3 x 400 V	3-pole		
M25	7,5 kW	25 A	KG20B.T203/WASIO1.STM	
M25	11 kW	32 A	KG32B.T203/WASIO1.STM	
M25	15 kW	40 A	KG41B.T203/WASIO1.STM	
M25	22 kW	63 A	KG64B.T203/WASIO1.STM	
M40	30 kW	80 A	KG80.T203/WASIO1.STM	
M40	37 kW	100 A	KG100.T203/WASIO1.STM	
M63	45 kW	125 A	KG125.T203/WASIO1.STM	
M63	55 kW	160 A	KG160.T203/WASIO1.STM	
M63	90 kW	250 A	KG250.T203/WASIO1.STM	
28-60 mm	110 kW	315 A	KG315.T203/WASIO1.STM	

Gland	Rating AC-23B (A)	Thermal current (I _v /I _{th})	Order number	Type of handle
	3 x 400 V	3-pole		
M25	7,5 kW	25 A	KG20B.T103/WASIO1.STM	
M25	11 kW	32 A	KG32B.T103/WASIO1.STM	
M25	15 kW	40 A	KG41B.T103/WASIO1.STM	
M25	22 kW	63 A	KG64B.T103/WASIO1.STM	
M40	30 kW	80 A	KG80.T103/WASIO1.STM	
M40	37 kW	100 A	KG100.T103/WASIO1.STM	
M63	45 kW	125 A	KG125.T103/WASIO1.STM	
M63	55 kW	160 A	KG160.T103/WASIO1.STM	
M63	90 kW	250 A	KG250.T103/WASIO1.STM	
28-60 mm	110 kW	315 A	KG315.T103/WASIO1.STM	

Notice:

The safety switches according to DIN EN 62626-1 Class 0 are equipped with a cover interlock which allows the cover to be removed in position "I" only. The basic requirements of these devices are derived from switch disconnectors in accordance with IEC 60947-3. Furthermore, our safety switches according to DIN EN 62626-1 Class 0 have the following characteristics:

- IK06 impact resistance according to IEC 62262
- Ingress protection rating of IP66/67 according to IEC60529
- AC-23A switching capacity according to IEC60947-3
- Cover interlock, to prevent the opening of the enclosure in "OFF" position
- 3 times lockable in OFF position
- Moisture heat, salt mist and vibration test, category A according to IEC60947-1 Annex Q

Maintenance switches designed for EMC compliant connecting of variable speed drives are equipped with shield brackets (KS- and KL- enclosures) or clamps mounted on rail (STM enclosure). Enabling a large scale uninterrupted transmission of the shield.

Maximum number of padlocks			
Padlock device	Face plate	Shackle-Ø	Number of padlocks
	64 x 64	9	3
	88 x 88	10	3

	A	B	D1	D3	H	L	R
KG20B, KG32B	64	190	25,5	16,5	130	190	17
KG41B, KG64B	64	190	40,5	16,5	130	190	17
KG80	88	280	40,5	20,5	180	280	17
KG100	88	280	50,5	20,5	180	280	17
KG125, KG160	88	280	50,5	20,5	180	560	17
KG250, KG315	88	380	63,5	25,5	180	560	17

SAFETY SWITCH ACC. TO DIN EN 62626-1 CLASS 0

For EMC-compliant connection ▶ 6-pole + 1 NO/NC, IP 66 / 67

EMC

Plastic enclosures with high mechanical stability, high UV resistance and wide terminal compartment space



6-pole

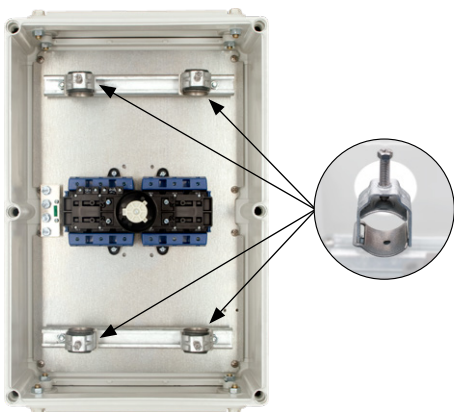

Similar image

KG

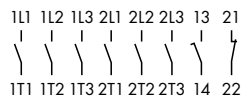

STM

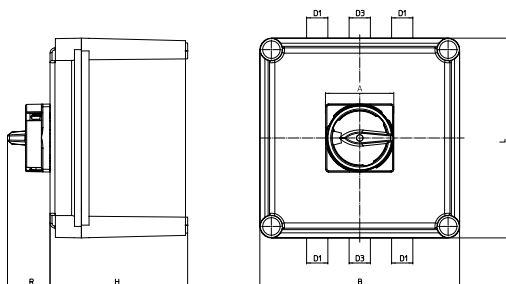

Notice: The outside-Ø is bigger for shielded cables

with Auxiliary contacts (1 NO + 1 NC)

Gland	Rating AC-23B (A)	Thermal current (I _{th} /I _n)	Order number	Type of handle
	3 x 400 V	6-pole		
M25	7,5 kW	25 A	KG20B.T206/WASIO1.STM	
M25	11 kW	32 A	KG32B.T206/WASIO1.STM	
M25	15 kW	40 A	KG41B.T206/WASIO1.STM	
M25	22 kW	63 A	KG64B.T206/WASIO1.STM	
M40	30 kW	80 A	KG80.T206/WASIO1.STM	
M40	37 kW	100 A	KG100.T206/WASIO1.STM	
M63	45 kW	125 A	KG125.T206/WASIO1.STM	
M63	55 kW	160 A	KG160.T206/WASIO1.STM	

Gland	Rating AC-23B (A)	Thermal current (I _{th} /I _n)	Order number	Type of handle
	3 x 400 V	6-pole		
M25	7,5 kW	25 A	KG20B.T106/WASIO1.STM	
M25	11 kW	32 A	KG32B.T106/WASIO1.STM	
M25	15 kW	40 A	KG41B.T106/WASIO1.STM	
M25	22 kW	63 A	KG64B.T106/WASIO1.STM	
M40	30 kW	80 A	KG80.T106/WASIO1.STM	
M40	37 kW	100 A	KG100.T106/WASIO1.STM	
M63	45 kW	125 A	KG125.T106/WASIO1.STM	
M63	55 kW	160 A	KG160.T106/WASIO1.STM	

Notice:

The safety switches according to DIN EN 62626-1 Class 0 are equipped with a cover interlock which allows the cover to be removed in position "I" only. The basic requirements of these devices are derived from switch disconnectors in accordance with IEC 60947-3. Furthermore, our safety switches according to DIN EN 62626-1 Class 0 have the following characteristics:

- IK06 impact resistance according to IEC 62262
- Ingress protection rating of IP66/67 according to IEC60529
- AC-23A switching capacity according to IEC60947-3
- Cover interlock, to prevent the opening of the enclosure in "OFF" position
- 3 times lockable in OFF position
- Moisture heat, salt mist and vibration test, category A according to IEC60947-1 Annex Q

Maintenance switches designed for EMC compliant connecting of variable speed drives are equipped with shield brackets (KS- and KL- enclosures) or clamps mounted on rail (STM enclosure). Enabling a large scale uninterrupted transmission of the shield.

Cable-Ø shield

	KG20 – KG64	12 – 16
	KG80/KG100	23 – 29
	KG125 – KG160	34

Maximum number of padlocks			
Padlock device	Face plate	Shackle-Ø	Number of padlocks
	64 x 64	9	3
	88 x 88	10	3

	A	B	D1	D3	H	L	R
KG20B, KG32B	64	190	25,5	16,5	130	280	17
KG41B, KG64B	64	190	40,5	16,5	130	280	17
KG80	88	280	40,5	20,5	130	560	17
KG100	88	280	50,5	20,5	130	560	17
KG125, KG160	88	280	50	20	180	560	17

Safety switch EMC-compliant



Stainless steel enclosures ▶ 3-pole + 1 NO/NC, IP 66

Stainless steel enclosures for rough environments

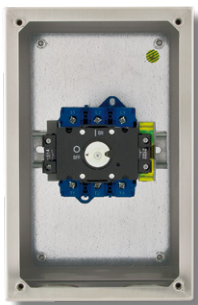

Similar image



Rating AC-23B (A)	Thermal current (Iu/Ith)	Order number
3 x 400 V	3-pole	
7,5 kW	25 A	KG20.T203/NLB512.IKN
11 kW	32 A	KG32.T203/NLB512.IKN
15 kW	40 A	KG41.T203/NLB512.IKN
22 kW	63 A	KG64.T203/NLB512.IKN
30 kW	80 A	KG80.T203/NLB512.IKN
37 kW	100 A	KG100.T203/NLB512.IKN

Rating AC-23B (A)	Thermal current (Iu/Ith)	Order number
3 x 400 V	3-pole	
7,5 kW	25 A	KG20.T103/NLB522.IKN
11 kW	32 A	KG32.T103/NLB522.IKN
15 kW	40 A	KG41.T103/NLB522.IKN
22 kW	63 A	KG64.T103/NLB522.IKN
30 kW	80 A	KG80.T103/NLB522.IKN
37 kW	100 A	KG100.T103/NLB522.IKN

Larger enclosures on request.

Suitable brackets for wall mounting

Two brackets are included per kit. 2 kits are required for KG80/100.



flat
KNBOX.ADH-WLBR300/2



high
KNBOX.ADH-WLBR301/2

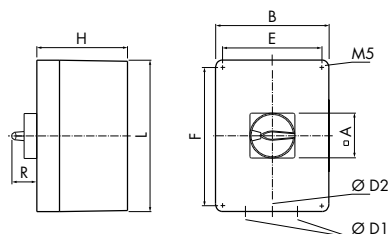
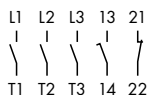

Padlock device	Face plate	Shackle-Ø	Number of padlocks
	64 x 64	9	3

	A	B	D1	D2	E	F	H	K	L	R
KG20, KG32	64	100	2 x 25	1 x 20	0	130	110	7,0	160	40,1
KG41, KG64	64	100	2 x 25	1 x 20	0	170	110	7,0	200	40,1
KG80, KG100	64	160	2 x 40	1 x 20	110	200	120	7,0	250	40,1

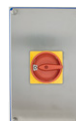

MAIN, SAFETY AND MAINTENANCE SWITCH

Stainless steel enclosures ▶ 4-pole + 1 NO/NC, IP 66

Stainless steel enclosures for rough environments

SS



4-pole

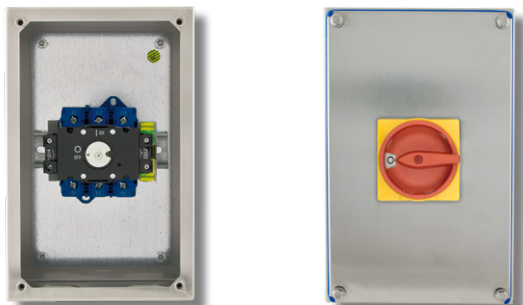

Similar image



Rating AC-23B (A)	Thermal current (Iu/Ith)	Order number
3 x 400 V	4-pole	
7,5 kW	25 A	KG20.T204/NLB512.IKN
11 kW	32 A	KG32.T204/NLB512.IKN
15 kW	40 A	KG41.T204/NLB512.IKN
22 kW	63 A	KG64.T204/NLB512.IKN
30 kW	80 A	KG80.T204/NLB512.IKN
37 kW	100 A	KG100.T204/NLB512.IKN

Rating AC-23B (A)	Thermal current (Iu/Ith)	Order number
3 x 400 V	4-pole	
7,5 kW	25 A	KG20.T104/NLB522.IKN
11 kW	32 A	KG32.T104/NLB522.IKN
15 kW	40 A	KG41.T104/NLB522.IKN
22 kW	63 A	KG64.T104/NLB522.IKN
30 kW	80 A	KG80.T104/NLB522.IKN
37 kW	100 A	KG100.T104/NLB522.IKN

Larger enclosures on request.

Suitable brackets for wall mounting

Two brackets are included per kit. 2 kits are required for KG80/100.



flat
KNBOX.ADH-WLBR300/2



high
KNBOX.ADH-WLBR301/2

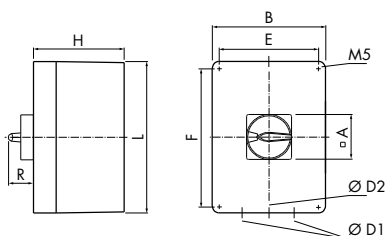
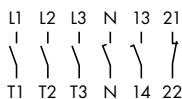

Padlock device	Face plate	Shackle-Ø	Number of padlocks
	64 x 64	9	3

	A	B	D1	D2	E	F	H	K	L	R
KG20, KG32	64	100	2 x 25	1 x 20	0	130	110	7,0	160	40,1
KG41, KG64	64	100	2 x 25	1 x 20	0	170	110	7,0	200	40,1
KG80, KG100	64	160	2 x 40	1 x 20	110	200	120	7,0	250	40,1



Aluminium enclosures ▶ 3-pole + 1 NO/NC, IP 65

Aluminium enclosures for rough environments Entries with thread

Material: DIN EN 1706 EN AC-AISI 12 (Fe)
Impact resistance: > 7 Joule according EN 50014
Varnishing: Powder coating
Color Tone: RAL 7001, silver gray

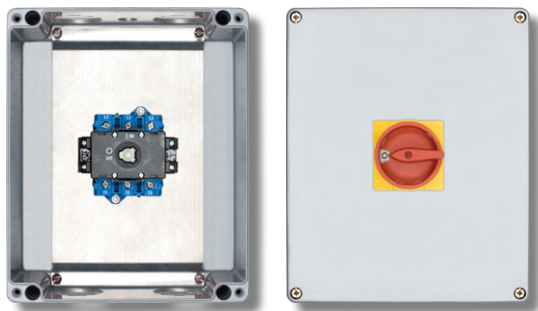

Similar image



Rating AC-23B (A)	Thermal current (Iu/Ith)	Order number
3 x 400 V	3-pole	
7,5 kW	25 A	KG20B.T203/D-A135.GKM
11 kW	32 A	KG32B.T203/D-A095.GKM
15 kW	40 A	KG41B.T203/D-A127.GKM
22 kW	63 A	KG64B.T203/D-A145.GKM
30 kW	80 A	KG80.T203/D-A096.GKM
37 kW	100 A	KG100.T203/D-A102.GKM
45 kW	125 A	KG125.T203/D-A056.GKM
55 kW	160 A	KG160.T203/D-A048.GKM
90 kW	250 A	KG250.T203/D-A048.GKM
110 kW	315 A	KG315.T203/D-A038.GKM

Rating AC-23B (A)	Thermal current (Iu/Ith)	Order number
3 x 400 V	3-pole	
7,5 kW	25 A	KG20B.T103/D-A102.GKM
11 kW	32 A	KG32B.T103/D-A048.GKM
15 kW	40 A	KG41B.T103/D-A076.GKM
22 kW	63 A	KG64B.T103/D-A079.GKM
30 kW	80 A	KG80.T103/D-A049.GKM
37 kW	100 A	KG100.T103/D-A053.GKM
45 kW	125 A	KG125.T103/D-A043.GKM
55 kW	160 A	KG160.T103/D-A035.GKM
90 kW	250 A	KG250.T103/D-A058.GKM
110 kW	315 A	KG315.T103/D-A040.GKM

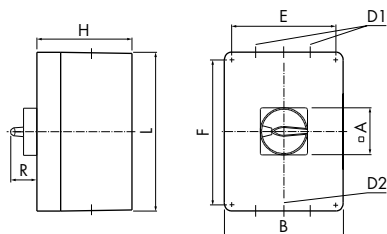
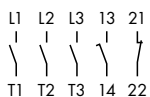

Padlock device	Face plate	Shackle-Ø	Number of padlocks
	64 x 64	9	3
	88 x 88	10	3

	A	B	D1	D2	E	F	H	K	L	R
KG20B, KG32B	64	122	2 x M25	2 x M25	82	106	90	7,0	120	40,1
KG41B, KG64B	64	180	1 x M40 1 x M20	1 x M40	130	160	100	7,0	180	40,1
KG80, KG100	64	230	2 x M50 1 x M20	2 x M50	180	260	110	7,0	280	40,1
KG125, KG160	88	230	2 x M50	2 x M50 1 x M20	180	310	180	7,0	330	49,3
KG250, KG315	88	310	2 x M63	2 x M63 1 x M20	262	382,5	180	7,0	400	49,3

ALU

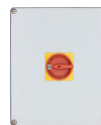

3-pole

Aluminium enclosures

MAIN, SAFETY AND MAINTENANCE SWITCH

Aluminium enclosures ▶ 4-pole + 1 NO/NC, IP 65

ALU

Aluminium enclosures for rough environments Entries with thread

Material: DIN EN 1706 EN AC-AISI 12 (Fe)
Impact resistance: > 7 Joule according EN 50014
Varnishing: Powder coating
Color Tone: RAL 7001, silver gray

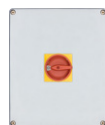

4-pole

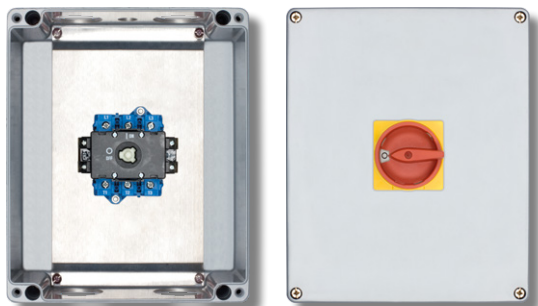

Similar image



Rating AC-23B (A)	Thermal current (Iu/Ith)	Order number
3 x 400 V	4-pole	
7,5 kW	25 A	<i>On request</i>
11 kW	32 A	KG32B.T204/D-A016.GKM
15 kW	40 A	KG41B.T204/D-A028.GKM
22 kW	63 A	KG64B.T204/D-A069.GKM
30 kW	80 A	KG80.T204/D-A026.GKM
37 kW	100 A	KG100.T204/D-A051.GKM
45 kW	125 A	KG125.T204/D-A020.GKM
55 kW	160 A	<i>On request</i>
90 kW	250 A	<i>On request</i>
110 kW	315 A	<i>On request</i>

Rating AC-23B (A)	Thermal current (Iu/Ith)	Order number
3 x 400 V	4-pole	
7,5 kW	25 A	KG20B.T104/D-A049.GKM
11 kW	32 A	KG32B.T104/D-A015.GKM
15 kW	40 A	KG41B.T104/D-A022.GKM
22 kW	63 A	KG64B.T104/D-A032.GKM
30 kW	80 A	KG80.T104/D-A031.GKM
37 kW	100 A	KG100.T104/D-A042.GKM
45 kW	125 A	KG125.T104/D-A022.GKM
55 kW	160 A	<i>On request</i>
90 kW	250 A	<i>On request</i>
110 kW	315 A	<i>On request</i>

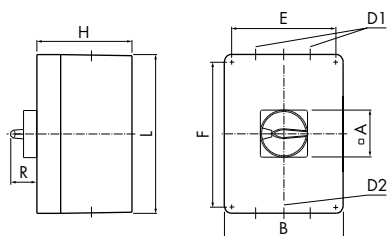
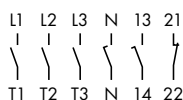

Maximum number of padlocks			
Padlock device	Face plate	Shackle-Ø	Number of padlocks
	64 x 64	9	3
	88 x 88	10	3

	A	B	D1	D2	E	F	H	K	L	R
KG20B, KG32B	64	122	2 x M25	2 x M25	82	106	90	7,0	120	40,1
KG41B, KG64B	64	180	1 x M50 1 x M20	1 x M50	130	160	100	7,0	180	40,1
KG80, KG100	64	230	2 x M50 1 x M20	2 x M50	180	260	110	7,0	280	40,1
KG125, KG160	88	230	2 x M50	2 x M50 1 x M20	180	310	180	7,0	330	49,3
KG250, KG315	88	310	2 x M63	2 x M63 1 x M20	262	382,5	180	7,0	400	49,3



Aluminium enclosures ▶ 6-pole + NO/NC, IP 65

Aluminium enclosures for rough environments Entries with thread

Material: DIN EN 1706 EN AC-AISI 12 (Fe)
Impact resistance: > 7 Joule according EN 50014
Varnishing: Powder coating
Color Tone: RAL 7001, silver gray

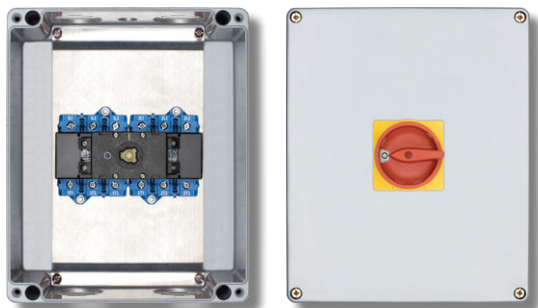

Similar image



Rating AC-23B (A)	Thermal current (Iu/Ith)	Order number
3 x 400 V	6-pole	
7,5 kW	25 A	KG20B.T206/D-A043.GKM
11 kW	32 A	KG32B.T206/D-A045.GKM
15 kW	40 A	KG41B.T206/D-A039.GKM
22 kW	63 A	KG64B.T206/D-A050.GKM
30 kW	80 A	KG80.T206/D-A045.GKM
37 kW	100 A	KG100.T206/D-A034.GKM
45 kW	125 A	KG125.T206/D-A017.GKM
55 kW	160 A	KG160.T206/D-A034.GKM

Rating AC-23B (A)	Thermal current (Iu/Ith)	Order number
3 x 400 V	6-pole	
7,5 kW	25 A	KG20B.T106/D-A038.GKM
11 kW	32 A	KG32B.T106/D-A029.GKM
15 kW	40 A	KG41B.T106/D-A029.GKM
22 kW	63 A	KG64B.T106/D-A033.GKM
30 kW	80 A	KG80.T106/D-A033.GKM
37 kW	100 A	KG100.T106/D-A026.GKM
45 kW	125 A	KG125.T106/D-A017.GKM
55 kW	160 A	KG160.T106/D-A018.GKM

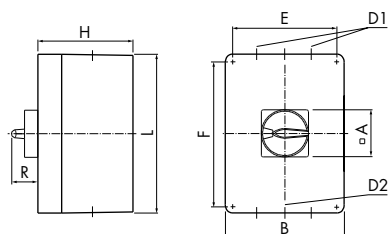
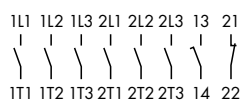

Maximum number of padlocks			
Padlock device	Face plate	Shackle-Ø	Number of padlocks
	64 x 64	9	3
	88 x 88	10	3

	A	B	D1	D2	E	F	H	K	L	R
KG20B, KG32B	64	180	2 x M25	2 x M25	106	82	100	7,0	180	40,1
KG41B	64	230	2 x M40 1 x M20	2 x M40	180	260	110	7,0	280	40,1
KG64B	64	230	2 x M50 1 x M20	2 x M50	180	260	110	7,0	280	40,1
KG80, KG100	64	230	2 x M50 1 x M20	2 x M50	180	260	110	7,0	280	40,1
KG125, KG160	88	400	2 x M63 2 x M20	2 x M63	382,5	262	180	7,0	310	49,3

ALU

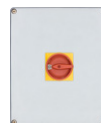

6-pole

Aluminium enclosures

MAIN, SAFETY AND MAINTENANCE SWITCH

ATEX ▶ Zone 22 and 21, 3-pole + 1NO/NC, IP 66



ATEX

Maintenance and safety switch acc. to EC ATEX-Directive 2014/34/EU, equipment group II, Category 2, Zone 21, explosive atmosphere "Dust", mechanical impact resistance 7J

2 x M25 ATEX cable glands, 2 x M32/M25 adaptors and 1 dummy plug M20 included



3-pole

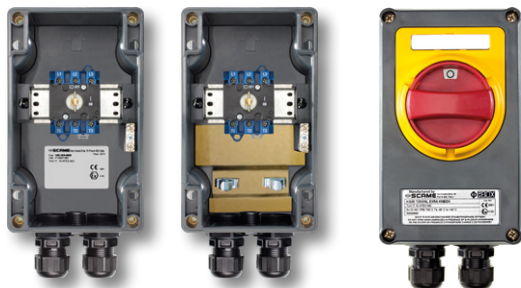

Similar image

EMC-Model



Utilization category AC-23B (A)	Thermal current (I _{the})	Order number
3 x 400 V	3-pole	
7,5 kW	25 A	KG20.T203/NL-EXRA.KNBOX
11 kW	32 A	KG32.T203/NL-EXRA.KNBOX
15 kW	40 A	KG41.T203/NL-EXRA.KNBOX
20 kW	55 A	KG64.T203/NL-EXRA.KNBOX
EMC-Model		
7,5 kW	25 A	KG20.T203/NL-EXRC.*KNBOX
11 kW	32 A	KG32.T203/NL-EXRC.*KNBOX
15 kW	40 A	KG41.T203/NL-EXRC.*KNBOX
20 kW	55 A	KG64.T203/NL-EXRC.*KNBOX

Utilization category AC-23B (A)	Thermal current (I _{the})	Order number
3 x 400 V	3-pole	
7,5 kW	25 A	KG20.T103/NL-EXBA.KNBOX
11 kW	32 A	KG32.T103/NL-EXBA.KNBOX
15 kW	40 A	KG41.T103/NL-EXBA.KNBOX
20 kW	55 A	KG64.T103/NL-EXBA.KNBOX
EMC-Model		
7,5 kW	25 A	KG20.T103/NL-EXBC.*KNBOX
11 kW	32 A	KG32.T103/NL-EXBC.*KNBOX
15 kW	40 A	KG41.T103/NL-EXBC.*KNBOX
20 kW	55 A	KG64.T103/NL-EXBC.*KNBOX

Notice for EMC-Model

Maintenance switches for EMC-compliant connection of FU-regulated drives use shield clips. These clips are used to continue the cable shield circuit through the enclosure. The configuration of the maintenance switch between FU and motor allows the use as disconnector up to 400 Hz and as load switch at frequencies from 40 Hz to 100 Hz. Each maintenance switch has as standard 2 auxiliary contacts, 1 NC and 1 NO. Via the NO (20 ms leading) the FU can be switched OFF before the main contacts of the switch open. For the rating of the switch please note that the motor may have approx. 10 % higher charging rate due to the higher loss in FU-operation e.g. a motor with 7,5 kW rating the motor current has to be determined with 16,7 A instead of 15,2 A.

3-pole + 1NO/1NC

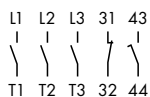

3-pole + 1NO/1NC EMC

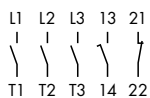

Cabel-Ø shield Shield clamp

	KG20-KG64	12 - 16
--	-----------	---------

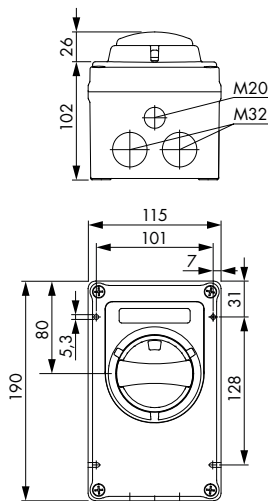

Maximal number of locks

Padlock device	U-bolt-Ø	Number of locks
	6	3



ATEX units

ATEX ▶ Zone 22 und 21, 3-pole + 1NO/NC, IP 66



Maintenance and safety switch acc. to EC ATEX-Directive 2014/34/EU, equipment group II, Category 2, Zone 21, explosive atmosphere "Dust", mechanical impact resistance 7J

2 x M25 ATEX cable glands, 2 x M32/M25 adaptors and 1 dummy plug M20 included



Similar image



Utilization category AC-23B (A)	Thermal current (I _{th})	Order number
3 x 400 V	3-pole	
7,5 kW	25 A	KG20.T203/NL-EXRC*KNSAF
11 kW	32 A	KG32.T203/NL-EXRC*KNSAF
15 kW	40 A	KG41.T203/NL-EXRC*KNSAF
20 kW	55 A	KG64.T203/NL-EXRC*KNSAF

Utilization category AC-23B (A)	Thermal current (I _{th})	Order number
3 x 400 V	3-pole	
7,5 kW	25 A	KG20.T103/NL-EXBC*KNSAF
11 kW	32 A	KG32.T103/NL-EXBC*KNSAF
15 kW	40 A	KG41.T103/NL-EXBC*KNSAF
20 kW	55 A	KG64.T103/NL-EXBC*KNSAF

Notice:

The safety switches according to DIN EN 62626-1 Class 1 are equipped with a cover interlock which allows the cover to be removed in position "I" only. The basic requirements of these devices are derived from switch disconnectors in accordance with IEC 60947-3. Furthermore, our safety switches according to DIN EN 62626-1 Class 1 have the following characteristics:

- High IK09 impact resistance according to IEC 62262
- Ingress protection rating of IP66 according to IEC60529
- AC-3 switching capacity according to IEC60947-4-1
- AC-23A switching capacity according to IEC60947-3
- Cover interlock, to prevent the opening of the enclosure in "OFF" position
- 3 times lockable in OFF position
- Moisture heat, salt mist and vibration test, category C and D according to IEC60947-1 Annex Q

3-pole + 1NO/1NC

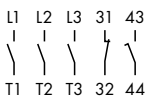

Cable-Ø shield	KG20-KG64	12 – 16

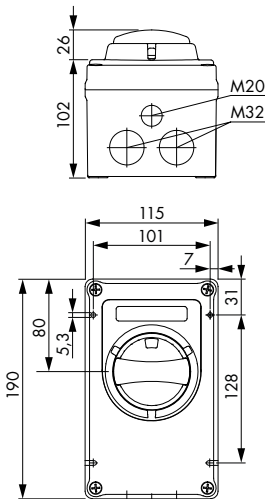

Maximal number of locks		
Padlock device	U-bolt-Ø	Number of locks
	6	3

ATEX



3-pole

Safety switch ATEX

MAIN, SAFETY AND MAINTENANCE SWITCH

ATEX ▶ Zone 22 and 21, 4-pole + 1NO/NC, IP 66



ATEX

Maintenance and safety switch acc. to EC ATEX-Directive 2014/34/EU, equipment group II, Category 2, Zone 21, explosive atmosphere "Dust", mechanical impact resistance 7J

2 x M25 ATEX cable glands, 2 x M32/M25 adaptors and 1 dummy plug M20 included



4-pole



Similar image



Utilization category AC-23B (A)	Thermal current (I _{the})	Order number
3 x 400 V	4-pole	
7,5 kW	25 A	KG20.T204/NL-EXRA.KNBOX
11 kW	32 A	KG32.T204/NL-EXRA.KNBOX
15 kW	40 A	KG41.T204/NL-EXRA.KNBOX
20 kW	55 A	KG64.T204/NL-EXR.KNBOX ¹

¹ Without auxiliary contacts

Utilization category AC-23B (A)	Thermal current (I _{the})	Order number
3 x 400 V	4-pole	
7,5 kW	25 A	KG20.T104/NL-EXBA.KNBOX
11 kW	32 A	KG32.T104/NL-EXBA.KNBOX
15 kW	40 A	KG41.T104/NL-EXBA.KNBOX
20 kW	55 A	KG64.T104/NL-EXBA.KNBOX

ATEX units

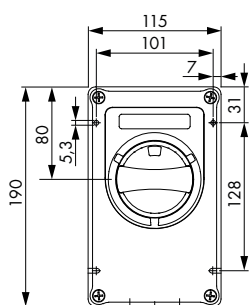
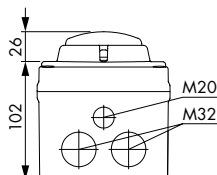

Cable-Ø shield	Shield clamp	
	KG20-KG64	12 - 16

Maximal number of locks		
Padlock device	U-bolt-Ø	Number of locks
	6	3



ATEX ▶ Zone 22 and 21, 6-pole + 1NO/NC, IP 66



Maintenance and safety switch acc. to EC ATEX-Directive 2014/34/EU, equipment group II, Category 2, Zone 21, explosive atmosphere "Dust", mechanical impact resistance 7J

2 x M32 ATEX cable glands and 1 dummy plug M20 included



Similar image



Utilization category AC-23B (A)	Thermal current (I _{the})	Order number
3 x 400 V	6-pole	
7,5 kW	25 A	KG20.T206/NL-EXRA.KNBOX
11 kW	32 A	KG32.T206/NL-EXRA.KNBOX

Utilization category AC-23B (A)	Thermal current (I _{the})	Order number
3 x 400 V	6-pole	
7,5 kW	25 A	KG20.T106/NL-EXBA.KNBOX
11 kW	32 A	KG32.T106/NL-EXBA.KNBOX

ATEX



6-pole

ATEX units

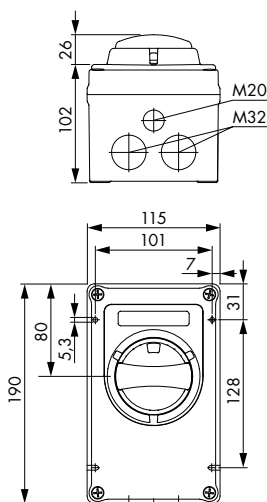
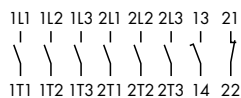

Maximal number of locks		
Padlock device	U-bolt-Ø	Number of locks
	6	3

MAIN, SAFETY AND MAINTENANCE SWITCH

Switch disconnecter according EN 60947-3, 3-pole, O - I

Base mounting 45 mm standard knock-out



Thermal current (I _v /I _{th})	Rating AC-23B (A)	Order number	Order number	Order number
3-pole 3 x 400 V				
20 A	5,7 kW	<i>without padlock device</i> KG10A.T303.VE21	<i>with integr. padlock device</i> KG10A.T303/58.VE21	<i>with integr. padlock device</i> KG10A.T203/58.VE21
25 A	7,5 kW	KG20A.T303.VE2	KG20A.T303/58.VE2	KG20A.T203/58.VE2
32 A	11 kW	KG32A.T303.VE2	KG32A.T303/58.VE2	KG32A.T203/58.VE2
40 A	15 kW	KG41.T303.VE2	KG41.T303/58.VE2	KG41.T203/58.VE2
		KG41.T303.VE2C ¹	KG41.T103/D-K001.VE2C ¹	KG41.T203/D-K001.VE2C ¹
63 A	22 kW	KG64.T303.VE2	KG64.T303/58.VE2	KG64.T203/58.VE2
		KG64.T303.VE2C ¹	KG64.T103/D-K001.VE2C ¹	KG64.T203/D-K001.VE2C ¹
80 A	30 kW	KG80.T303.VE2	KG80.T303/58.VE2	KG80.T203/58.VE2
100 A	37 kW	KG100.T303.VE2	KG100.T303/58.VE2	KG100.T203/58.VE2
125 A	45 kW	KG125.T303.VE2	KG125.T303/58.VE2	KG125.T203/58.VE2
160 A	55 kW	KG160.T303.VE2	KG160.T303/58.VE2	KG160.T203/58.VE2



KG10A

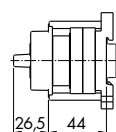

KG20A-KG160

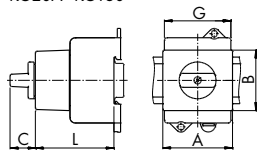

¹ Not for base mounting 45 mm standard knock-out, but wire connection without demounting of handle and escutcheon plate.

	A	B	without padlock device	with padlock device	G	L
KG20A, KG32A	43,7	45	22	28	42	61,5
KG41 ...VE2, KG64 ...VE2	52	45	22	28	50	61,5
KG41 ...VE2C, KG64 ...VE2C	52	39	22	28	50	61,5
KG80, KG100	70	45	26	30	70	65
KG125, KG160	112	45	33,8	41,6	112	98

Four hole panel mounting, IP66



Thermal current (I _v /I _{th})	Rating AC-23B (A)	Face plate	Order number
3-pole 3 x 400 V			
20 A	5,5 kW	48 x 48 64 x 64	KG10A.T303.E KG10B.T303.E
25 A	7,5 kW	48 x 48 64 x 64	KG20A.T303.E KG20B.T303.E
32 A	11 kW	48 x 48 64 x 64	KG32A.T303.E KG32B.T303.E

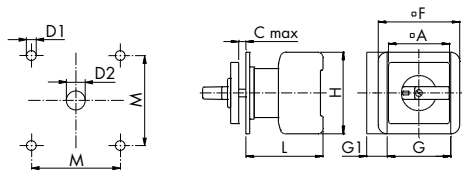

	Switch						Hole pattern		
	A	C	F	G	H	L	M	D1	D2
KG10A	48	4	48	48	50	48,2	36	5	11-15
KG10B	64	4	64	48	50	52,2	48	5	11-15
KG20A/KG32A	48	4	48	42	54	53,8	36	5	10
KG20B/KG32B	64	4	64	42	54	53,8	48	5	10

Single hole mounting 22 mm, IP66



Thermal current (I _v /I _{th})	Rating AC-23B (A)	Face plate	Order number
3-pole 3 x 400 V			
20 A	5,5 kW	48 x 48 64 x 64	KG10A.T303.FT2 KG10A.T303.FH3
25 A	7,5 kW	48 x 48 64 x 64	KG20A.T303.FT2 KG20A.T303.FH3
32 A	11 kW	48 x 48 64 x 64	KG32A.T303.FT2 KG32A.T303.FH3

KG10A

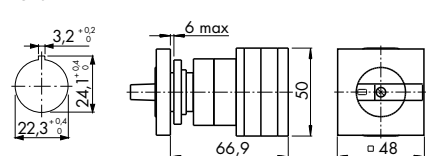

KG20A/KG32A

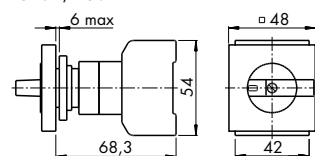

Switch disconnecter according EN 60947-3, Double-throw switch 4-pole, POWER – 0 – EMERGENCY POWER

Base mounting 45 mm standard knock-out

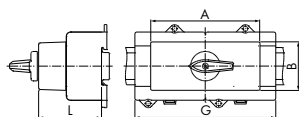
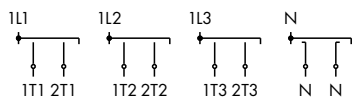

Thermal current (I _v /I _{th})	Rating AC-23B (A)	Order number
4-pole	3 x 400 V	
25 A	7,5 kW	KG20A.T904*D-A010.VE2
32 A	11 kW	KG32A.T904*D-W002.VE2
40 A	15 kW	KG41B.T904*D-W010.VE2
63 A	22 kW	KG64B.T904*D-A005.VE2
80 A	30 kW	KG80.T904*D-W001.VE2
100 A	37 kW	KG100.T904*D-W005.VE2
125 A	45 kW	KG125.T904/D-A084.VE2

	A	B	G	L
KG20A, KG32A	43,7	45	111	64
KG41B, KG64B	105,4	45	132	62,5
KG80, KG100	70,2	45	184	76,5
KG125	112	45	300	101,5



4-pole

Switch disconnecter according EN 60947-3, Double-throw switch, 4-pole, 1-0-2

Four hole panel mounting, IP66

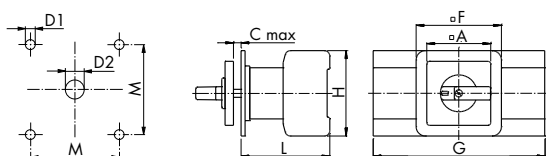
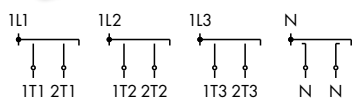

Thermal current (I _v /I _{th})	Rating AC-23B (A)	Face plate	Order number
4-pole	3 x 400 V		
25 A	7,5 kW	48 x 48 64 x 64	KG20A.T904.E KG20B.T904.E
32 A	11 kW	48 x 48 64 x 64	KG32A.T904.E KG32B.T904.E
40 A	15 kW	64 x 64	KG41B.T904.E
63 A	22 kW	64 x 64	KG64B.T904.E
80 A	30 kW	64 x 64	KG80.T904.E
100 A	37 kW	64 x 64	KG100.T904.E
125 A	45 kW	88 x 88	KG125.T904.E
160 A	55 kW	88 x 88	KG160.T904.E

	Switch						Hole pattern		
	A	C	F	G	L	H	M	D1	D2
KG20A, KG32A	48	4	48	111	61,3	54	36	5	10
KG20B, KG32B	64	4	64	111	61,3	54	48	5	10
KG41B, KG64B	64	4	64	132	66,5	64	48	5	10
KG80, KG100	64	4	70	184	81,8	80	48	5	10
KG125, KG160	88	5,5		300	98	108	68	6	13

Base mounting with shaft extension¹, IP 40

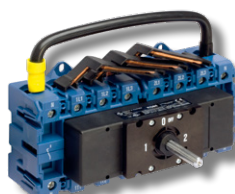

Face plate
KG20B-KG100

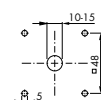

KG125, KG160

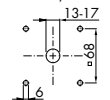

Mounting plate
KG20B-KG100

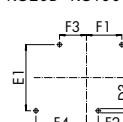

KG125, KG160

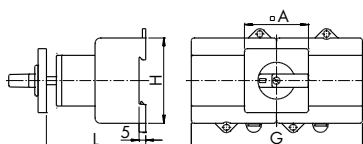
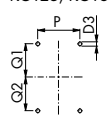

Thermal current (I _v /I _{th})	Rating AC-23B (A)	Face plate	Order number
4-pole	3 x 400 V		
25 A	7,5 kW	64 x 64	KG20B.T904/57.VE
32 A	11 kW	64 x 64	KG32B.T904/57.VE
40 A	15 kW	64 x 64	KG41B.T904/57.VE
63 A	22 kW	64 x 64	KG64B.T904/57.VE
80 A	30 kW	64 x 64	KG80.T904/57.VE
100 A	37 kW	64 x 64	KG100.T904/57.VE
125 A	45 kW	88 x 88	KG125.T904/57.VE
160 A	55 kW	88 x 88	KG160.T904/57.VE

	Switch				Hole pattern						
	A	G	L	H	D3	E1	F1	F2	F3	F4	
KG20B, KG32B	64	111	190	54	4,1	60	32	10	23,5	45,5	
KG41B	64	132	190	64	4,1	70	37,5	12,5	28,5	53,5	
KG64B	64	132	330	64	4,1	70	37,5	12,5	28,5	53,5	
KG80	64	184	380	80	5,2	90	47,5	22,5	44,5	69,5	
KG100	64	184	450	80	5,2	90	47,5	22,5	44,5	69,5	
A	G	L	H	D3	P	Q1	Q2				
KG125, KG160 ²	88	300	450	108	6	76	59-61	59-61			

¹ without door clutch, shaft will be conducted directly through the cover. On request, door clutch as an optional extra, we recommend M700 (page 79).

² not for DIN rail

MAIN, SAFETY AND MAINTENANCE SWITCH

Solder Joint Terminal

Direct mounting on printed board

KG21A, KG33A

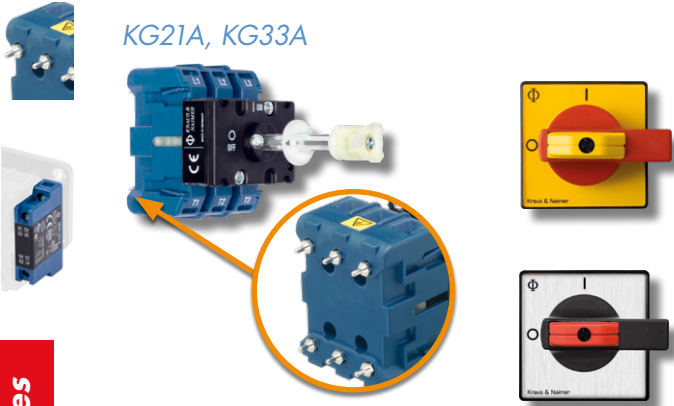

This switch will be used when a circuit breaker is needed directly on a circuit board.

Thermal current (I _n /I _{th})	Rating AC-23B (A)	Face plate	Order number
3-pole	3 x 400 V		
25 A	7,5 kW	48 x 48	KG21A.T203/68.VE
32 A	11 kW	48 x 48	KG33A.T203/68.VE

Thermal current (I _n /I _{th})	Rating AC-23B (A)	Face plate	Order number
3-pole	3 x 400 V		
25 A	7,5 kW	48 x 48	KG21A.T103/68.VE
32 A	11 kW	48 x 48	KG33A.T103/68.VE

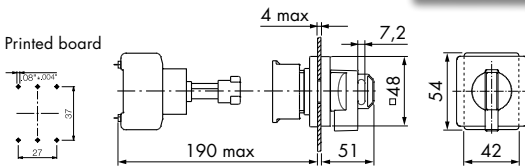

Maximum number of padlocks		
Face plate	Shackle-Ø	Number of padlocks
48 x 48	7	3
	5	4

Auxiliary contacts, Ground/Neutral terminals, Neutral contacts

Auxiliary contacts: NO quasi immediately closing with main contacts, NO lagging see next page

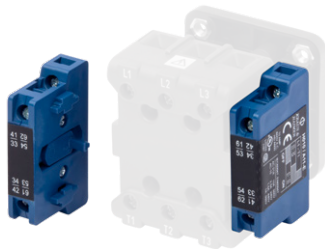

KG20-KG100C: 1 NO + 1 NC, KG125-KG317: 2 NO + 1 NC

Auxiliary contact blocks for mounting E, FT1, FT2		
	not overlapping	overlapping
KG20-KG32B	K0.H010/A11-E	K0.H010/B11-E
KG41-KG64B	K1.H010/A11-E	K1.H010/B11-E
KG80-KG100C	K2.H010/A11-E	K2.H010/B11-E
KG125-KG160	K3A.H010/A21-E	K3A.H010/B21-E
KG210-KG317	K3.H010/A21-E	K3.H010/B21-E

Auxiliary contact blocks for mounting VE, VE2, enclosures		
	not overlapping	overlapping
KG20-KG32B	K0.H010/A11-VE	K0.H010/B11-VE
KG41-KG64B	K1.H010/A11-VE	K1.H010/B11-VE
KG80-KG100 C	K2.H010/A11-VE	K2.H010/B11-VE
KG125-KG160	K3A.H010/A21-VE	K3A.H010/B21-VE
KG210-KG317	K3.H010/A21-VE	K3.H010/B21-VE

Connection description of auxiliary contacts					
KG20-KG100C	E, FT1, FT2		VE, VE2, enclosures		
	left	right	left	right	
not overlapping	33 41	53 61	31 43	51 63	
	34 42	54 62	32 44	52 64	
overlapping	33 41	53 61	31 43	51 63	
	34 42	54 62	32 44	52 64	

KG125-KG317 ²	E, FT1, FT2		VE, VE2, enclosures		
	left	right	left	right	
not overlapping	031 032	061 062	NC Above	011 012 041 042	NC Above
	023 024	053 054	NO Middle	023 024 053 054	NO Middle
	013 014	043 044	NO Below	033 034 063 064	NO Below
overlapping	031 032	061 062	NC Above	011 012 041 042	NC Above
	023 024	053 054	NO Middle	023 024 053 054	NO Middle
	013 014	043 044	NO Below	033 034 063 064	NO Below

	Ground terminal	Neutral terminal	Neutral contact
KG20-KG32B	K0.H052/A ¹	K0.H053/A ¹	-
KG41-KG64B	K1.H052/B ¹	K1.H053/B ¹	-
KG80-KG100C	K2.H052/C ¹	K2.H053/C ¹	-
KG125	K3.H052/H ^E	K3.H053/H ^E	K3.H050/P ^E
KG126	K3.H052/J ^E	K3.H053/J ^E	K3.H050/Q ^E
KG127	K3.H052/K ^E	K3.H053/K ^E	K3.H050/R ^E
KG160	K3.H052/H ^E	K3.H053/H ^E	K3.H050/S ^E
KG161	K3.H052/J ^E	K3.H053/J ^E	K3.H050/T ^E
KG162	K3.H052/K ^E	K3.H053/K ^E	K3.H050/U ^E
KG210, KG250	K3.H052/D ^E	K3.H053/D ^E	K3.H050/G ^E
KG211, KG251	K3.H052/E ^E	K3.H053/E ^E	K3.H050/H ^E
KG212, KG252	K3.H052/F ^E	K3.H053/F ^E	K3.H050/J ^E
KG315	K3.H052/D ^E	K3.H053/D ^E	K3.H050/K ^E
KG316	K3.H052/L ^E	K3.H053/L ^E	K3.H050/L ^E
KG317	K3.H052/M ^E	K3.H053/M ^E	K3.H050/M ^E
E	E	E	E
VE, Enclosures	VE	VE	VE

¹ Usable for E and VE mounting

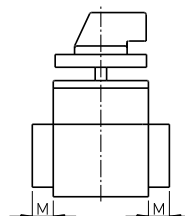

	Auxiliary contacts	M	Ground, neutral, add. main contact
KG20-KG32B	10		13,5
KG41-KG64B	11		16
KG80-KG100C	11		22
KG125-KG162	14		38
KG210-KG317	14		52,5

² 4-pole main switches, only 1 auxiliary contact can be mounted on the left side.
4-pole Change-over switches, no auxiliary contact can be mounted.



Cam and rack operated auxiliary contacts

Necessary Ordering Information: Number and operation mode of auxiliary contacts and system of contacts

NO lagging on and pre-closing OFF (Upgrade only NO quasi immediately closing on previous page)

M510A



Cam operated auxiliary contacts KG20 – KG100C (only factory provided)

All switches can be prepared with max. 4 auxiliary contacts.

You can choose between contact systems with a rigid contact bridge for high AC-15 switching capacity and contacts with gold plating for low voltage or low current. Special programs are available.

E, FT1, FT2

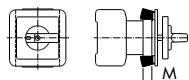

VE, VE2, Enclosures

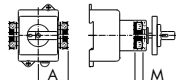

Type	M (E, FT1, FT2)		A	M (VE, VE2, enclosures)	
	1 or 2 contacts	3 or 4 contacts		1 or 2 contacts	3 or 4 contacts
KG20-KG32B	9	25,8	-	9	25,8
KG41-KG64B	10	30	-	10	30
KG80-KG100C	10	30	47,2	10	30

M510B



Rack operated auxiliary contacts KG125 – KG317 (only factory provided)

The Switch types KG125-KG162 can be used with max. 4 and the Switch types KG210-KG317 with max. 6 auxiliary contacts.

You can choose between contact systems with a rigid contact bridge for high AC-15 switching capacity and contacts with gold plating for low voltage or low current.

E

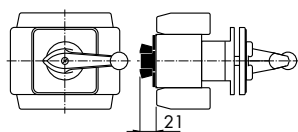

VE

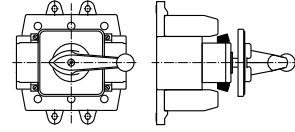

Additional PE-/N-terminals for KS- and KL-enclosures



The enclosures are already equipped with a PE terminal.

Enclosures	Order number
KS51V	K0B.T410.A
KL51V	K0B.T410.A
KL11V	K1B.T410.A
KL71V	K2B.T410.A

Shield wheeling kits for retrofitting (EMC application) KS- and KL-enclosures



Shielding clamp suitable for double side connecting. Scope of delivery: panel sheet, 2 shielding clamps, mounting screws

Shield wheeling kit available for 3 pole switches up to KG100.... And 6 pole switches up to KG64. All relevant catalogue listed maintenance switches can be upgraded with shield wheeling kits. The switch body has to be demounted first before mounting the shield wheeling.

Standard KS- and KL-enclosures				
Dimensions enclosure	85 x 120	85 x 160	100 x 190	145 x 250
External-Ø shield	9 – 11	12 – 16	12 – 16	23 – 29
Order number	S0E.T400.MA	K0B.T400.MA	K1B.T400.MA	K2B.T400.MA

Shielding clamp (separate) incl. mounting screws



Shielding clamp (separate)						
External-Ø shield	3 – 6	6 – 8	9 – 11	12 – 16	17 – 22	23 – 29
Order number	K1B.T400.KG	K1B.T400.KF	K1B.T400.KB	K1B.T400.KC	K1B.T400.KD	K1B.T400.KE

MAIN, SAFETY AND MAINTENANCE SWITCH

Protective covers

The terminals of the Switch types KG10-KG160 are according to EN 50274 and BGV A3 finger-proof, and up to KG64 also IP 20. KG80 to KG160 has one terminal cover and from KG210 to KG315 they have two terminal covers included in the scope of delivery of the MAIN, SAFETY AND MAINTENANCE SWITCH.

For KG-Switch with Box Terminal

Scope of delivery: single side terminal covers

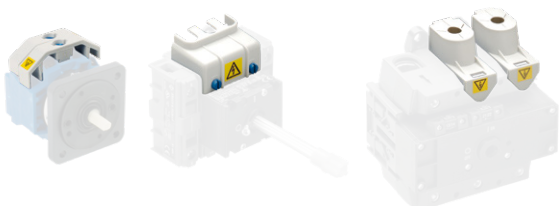

KG10

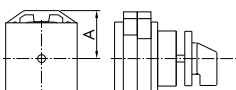

KG20-KG80C

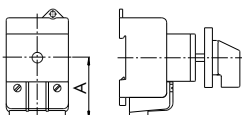

KG125-KG315

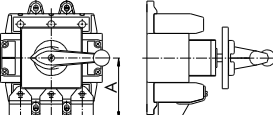

Switch type	2-pole	3- and 4-pole
KG10A, KG10B	S0.M160/A12	S0.M160/A12.K2
	3-pole	4-pole
KG20A, KG20B KG32A, KG32B	K0.M160/3	K0.M160/4
KG41, KG41B KG64, KG64B	K1.M160/3	K1.M160/4
KG80, KG80C KG100, KG100C	K2.M160/3	K2.M160/4
KG125, KG160	K3.M160/32	K3.M160/42
KG210, KG250 KG315	K3.M160/30	K3.M160/40

	A
KG10A/ KG10B	30
KG20-KG32B	47
KG41-KG64B	49
KG80-KG100C	66
KG125, KG160	76,2
KG210, KG250, KG315	88

For KG-switch with bolt terminal and C316

KG

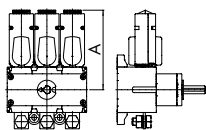

C316

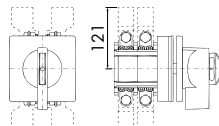

Scope of delivery: for the KG-switches one terminal cover for one side and for the C316 one terminal.

Switch type	3-pole	4-pole
KG126/ 127, KG161/ 162	K3.M160/33	K3.M160/43
KG211/ 212, KG251/ 252 KG316/ 317	K3.M160/31	K3.M160/41
C316	Cover for one terminal S3.M160/E06	

	A
KG126/ 127, KG161/ 162	112
KG211/ 212, KG251/ 252, KG316/ 317	160

Terminals for control circuit

For KG-switches with box terminal or bolt terminal



K3A.D720.KS
K3B.D520.KS

K1B.D220.KS
K2B.D520.KSA

Switch type	Order number	Max. wire gage mm ²	
		single or multiple wire	flexible wire
KG41-KG64B	K1B.D220.KS	2,5 mm ² / AWG12	2,5 mm ² / AWG14
KG80-KG100C	K2B.D520.KSA	2,5 mm ² / AWG12	2,5 mm ² / AWG14
KG125-KG162	K3A.D720.KS	4 mm ² / AWG10	4 mm ² / AWG12
KG210-KG317, C316	K3B.D520.KS	4 mm ² / AWG10	4 mm ² / AWG12

For KG-double-throw switch with box terminal incl. connecting bridge



Switch type	Order number	Max. wire gage mm ²	
		single or multiple wire	flexible wire
KG80-KG100C ¹	K2B.D520.KSB	2,5 mm ² / AWG12	2,5 mm ² / AWG14

¹ not finger-proof

Connections aids

For KG-switches with bolt terminal



Switch type	Order number
KG126/ 127/ 161/ 162	K3A.D720.09



Bolt terminal, ON-OFF switch 3- and 4-pole



KG-switches from KG125 can be supplied with bolt terminals on both sides, or with bolt terminal on top and box terminal at the bottom.

Rated continuous current (I_n/I_{th})	Bolt terminal top and bottom	Bolt terminal on top Box terminal at the bottom
3-pole, 4-pole		
125 A	KG126	KG127
160 A	KG161	KG162
200 A	KG211	KG212
250 A	KG251	KG252
315 A	KG316	KG317

4-hole panel mounting

Base mounting

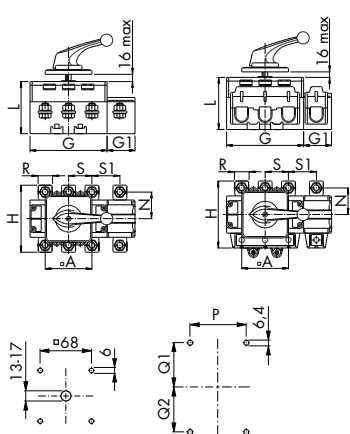
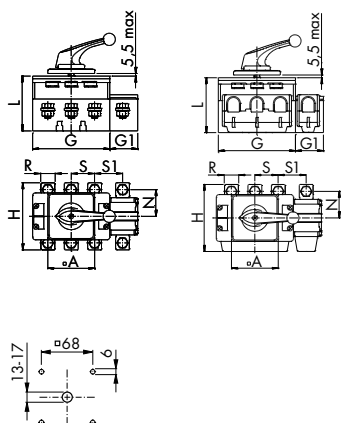

4-hole panel mounting	A	G	G1 ¹	H	L	N	R	S	S1
KG126, KG127, KG161, KG162	88	112	38	110	96	45	20	36	38
KG211, KG212, KG251, KG252	88	145	52,5	126	103	50	26	44	52,5
KG316, KG317	88	145	52,5	126	103	50	26	52	52,5

Base mounting	A	G	G1 ¹	H	L	N	R	S	S1
KG126, KG127, KG161, KG162	88	112	38	110	91	45	20	36	38
KG211, KG212, KG251, KG252	88	145	52,5	126	98	50	26	44	52,5
KG316, KG317	88	145	52,5	126	98	50	26	52	52,5

	P	Q1	Q2
KG126, KG161	36	38-40	38-40
KG127, KG162	36	38-40	59-61
KG211, KG251, KG316	44	40-42	40-42
KG212, KG252, KG317	44	40-42	70-72

¹ For ON/OFF switch 4-pole

Bolt terminal, ON-OFF switch 6- and 8-pole, Double-throw switch 3- and 4-pole



KG-switches KG125 and KG160 can be supplied with bolt terminals on both sides, or with bolt terminal on top and box terminal at the bottom.

Rated continuous current (I_n/I_{th})	Bolt terminal top and bottom ¹	Bolt terminal on top Box terminal at the bottom ²
Ausschalter 6- und 8-pole, Umschalter 3- und 4-pole		
125 A	KG126	KG127
160 A	KG161	KG162

¹ Double-throw switch without jumpers
² Double-throw switch jumpers at the bottom

4-hole panel mounting

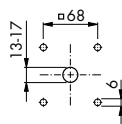
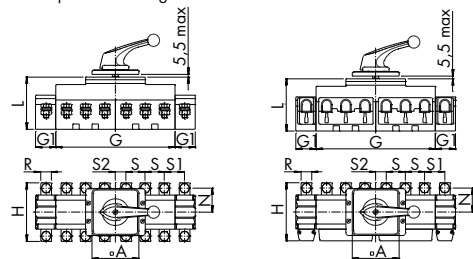

Base mounting

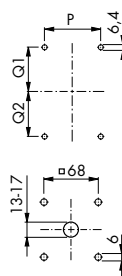
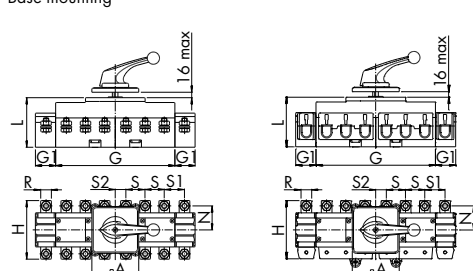

	A	G	G1 ¹	H	L	N	R	S	S1	S2
KG126, KG161	88	224	38	110	98	45	20	36	38	20
KG127, KG162	88	224	38	110	98	45	20	36	38	20

¹ For ON/OFF switch 8-pole and Double-throw switch 4-pole

	A	G	G1 ¹	H	L	N	R	S	S1	S2
KG126, KG161	88	224	38	110	93	45	20	36	38	20
KG127, KG162	88	224	38	110	93	45	20	36	38	20

¹ For ON/OFF switch 8-pole and Double-throw switch 4-pole

	P	Q1	Q2
KG126, KG161	76	38-40	38-40
KG127, KG162	76	38-40	59-61

MAIN, SAFETY AND MAINTENANCE SWITCH

Special tool to unlock the door clutch M700/.

S1D.M700.09



To open the door in ON-position at any case of service and maintenance.

Accessory single hole mounting

**Nut key for fixation,
Single hole mounting 16, 22 and 30 mm**

S00.T170.09



Adaptor ring for single hole mounting 22 mm to Ø 30 mm

S0E.T160.01

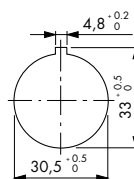

Mounting nut for 5 - 8 mm switch panel, 22 mm

S0E.T170.09



Metal ring to enhance protection against twist, 22 mm

S1D.V844.05



Mounting screws



Usually included

Self-tapping screw 4,7x13

S1E.T100.N 4 Pack

S1E.T100.10 1 Piece

For increased wall thicknesses

Self-tapping screw 4,7x19

S1E.T100.11 1 Piece

Self-tapping screw 4,7x30

S1E.T100.13 1 Piece



Add-on face plates for main switches

Large title block, face plate frame black



Inscription	Face plate size	Face plate background	Face plate background
MAIN SWITCH	48 X 48	yellow	brushed alu
	64 X 64	S0.F822/E1B-PRA	S0.F822/A1B-PRA
	88 X 88	S1.F822/E1B-PRA	S1.F822/A1B-PRA
	130 X 130	S2.F822/E1B-PRA	S2.F822/A1B-PRA
MAIN SWITCH Only open in 0-position	48 X 48	S0.F832/E1B-PRA	S0.F832/A1B-PRA
	64 X 64	S1.F832/E1B-PRA	S1.F832/A1B-PRA
	88 X 88	S2.F832/E1B-PRA	S2.F832/A1B-PRA
	130 X 130	S3.F832/E1B-PRA	S3.F832/A1B-PRA
MAIN SWITCH	48 X 48	S0.F836/E1B-PRA	S0.F836/A1B-PRA
	64 X 64	S1.F836/E1B-PRA	S1.F836/A1B-PRA
	88 X 88	S2.F836/E1B-PRA	S2.F836/A1B-PRA
	130 X 130	S3.F836/E1B-PRA	S3.F836/A1B-PRA
MAIN SWITCH	48 X 48	S0.F824/E1B-PRA	S0.F824/A1B-PRA
	64 X 64	S1.F824/E1B-PRA	S1.F824/A1B-PRA
	88 X 88	S2.F824/E1B-PRA	S2.F824/A1B-PRA
	130 X 130	S3.F824/E1B-PRA	S3.F824/A1B-PRA
MAIN SWITCH OPEN IN OFF-POSITION	48 X 48	S0.F838/E1B-PRA	S0.F838/A1B-PRA
	64 X 64	S1.F838/E1B-PRA	S1.F838/A1B-PRA
	88 X 88	S2.F838/E1B-PRA	S2.F838/A1B-PRA
	130 X 130	S3.F838/E1B-PRA	S3.F838/A1B-PRA
WITHOUT	48 X 48	S0.F991/EOB-PRA	S0.F991/AOB-PRA
	64 X 64	S1.F991/EOB-PRA	S1.F991/AOB-PRA
	88 X 88	S2.F991/EOB-PRA	S2.F991/AOB-PRA
	130 X 130	S3.F991/EOB-PRA	S3.F991/AOB-PRA

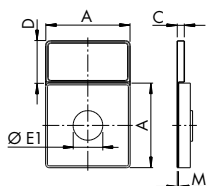

Size	A	C	D	E1	M
S0	48	4	24	22	0,7
S1	64	5	28	22/39,7	0,8
S2	88	6	36	39,7	1
S3	130	7	50	39,7	1,2

Flat inscription field, face plate frame black



Inscription	Face plate size	Face plate background	Face plate background
MAIN SWITCH	48 X 48	yellow	brushed alu
	64 X 64	S0.F822/E1B-PRC	S0.F822/A1B-PRC
MAIN SWITCH Only open in 0-position	48 X 48	S1.F822/E1B-PRC	S1.F822/A1B-PRC
	64 X 64	S0.F832/E1B-PRC	S0.F832/A1B-PRC
MAIN SWITCH	48 X 48	S1.F832/E1B-PRC	S1.F832/A1B-PRC
	64 X 64	S0.F836/E1B-PRC	S0.F836/A1B-PRC
MAIN SWITCH	48 X 48	S1.F836/E1B-PRC	S1.F836/A1B-PRC
	64 X 64	S0.F824/E1B-PRC	S0.F824/A1B-PRC
MAIN SWITCH	48 X 48	S1.F824/E1B-PRC	S1.F824/A1B-PRC
	64 X 64	S0.F838/E1B-PRC	S0.F838/A1B-PRC
MAIN SWITCH OPEN IN OFF-POSITION	48 X 48	S1.F838/E1B-PRC	S1.F838/A1B-PRC
	64 X 64	S0.F991/EOB-PRC	S0.F991/AOB-PRC
without	48 X 48	S1.F991/EOB-PRC	S1.F991/AOB-PRC
	64 X 64	S0.F991/EOB-PRC	S0.F991/AOB-PRC

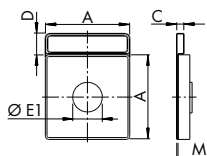

Size	A	C	D	E1	M
S0	48	4	12	22	0,7
S1	64	5	15	22/39,7	0,8



Integrated door clutch for enclosures

Door clutch with four hole mounting

M280E / -EF

Necessary ordering information: Entire mounting depth from switch incl. door clutch.

With shaft extension, IP 66/67 in front

When a padlock device is required, please specify.

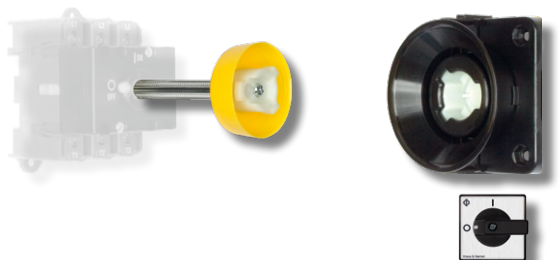

Model	
M280E/A 2	1 S-EF
A	= Without interlock by door clutch
B	= With interlock by door clutch
C	= With interlock by a connecting rod
D	= With interlock by door clutch and a connecting rod
	= Dimension L see the below

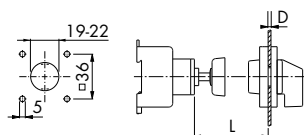

Face plate 48 x 48: KG10A, KG20A, KG32A

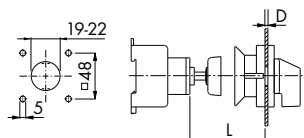

Face plate 64 x 64: KG10B, KG20B, KG32B, KG41B, KG64B, KG80, KG100

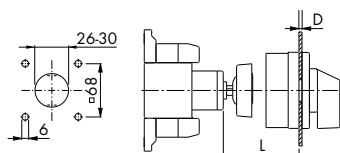

Face plate 88 x 88: KG125-KG317

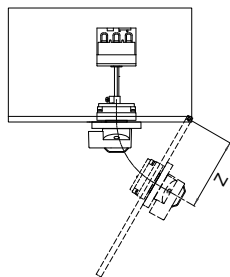

Hinge distance

For switch size see page 84.

Face plate 48 x 48	1	2	3	4	Z	
KG10A	4,0	36-55	56-75	75-95	96-116	100
KG20A, KG32A	4,0	58,5-66	78,5-86	98,5-106	118,5-126	100

Face plate 64 x 64	1	2	3	4	Z	
KG10B	4,0	32-57	58-77	78-97	98-118	100
KG20B, KG32B	4,0	57,5-65	77,5-85	97,5-105	117,5-125	100
KG41B, KG64B	4,0	62-72	82-92	102-112	122-132	100
KG80, KG100	4,0	60-70	80-90	100-110	120-130	100

Face plate 88 x 88	1	2	3	4	Z	
KG125-KG317	5,5	93-109	123-139	153-169	183-199	110

Optional extras for customizing (available only in combination with a switch) — Optional extras



Padlock device with integrated door clutch for control panel

Door clutch with four hole mounting, IP 66

Ordering Example: Entire mounting depth from switch incl. door clutch.

M700/.



Handle lockable with padlocks

The M700/ provides multiple lock functions. Standard operation: cabinet door is locked in position "I" and can only be opened in position "O". With a special tool (included in the package) the door lock in "I" position can be permanently removed. Maintenance operation: After a padlock device is applied (only possible in "O" position) cabinet door and switch are locked. A maximum of 4 padlocks with max. 5 mm U-bolt diameter or 3 padlocks with max. 8 mm U-bolt diameter are possible. When the center of the shaft is OFFset by ± 5 mm compared to the door coupling, this will be compensated.

A shaft extension is required.

Coloring	Face plate	Handle	Lock bar
M700/A			
A	= Brushed Alu	black	red
B	= Brushed Alu	red	yellow
C	= Brush black	black	red
D	= Brush black	red	yellow
E	= Yellow	red	yellow

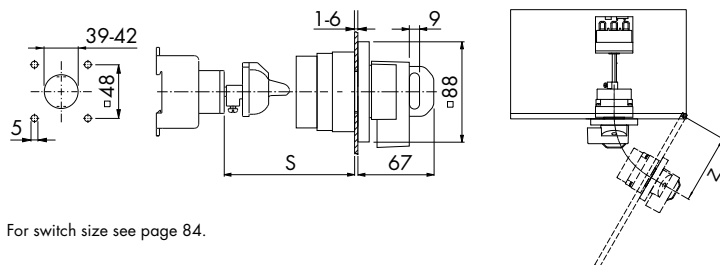

For switch size see page 84.

	S min	Z
KG20B, KG32B	64,5	100
KG41B, KG64B	64,5	100
KG80, KG100	64,5	100
KG125-KG317	74	100

Unlock insert for door clutch M700/.

SID.M700.29



Enables door opening in „On" position and permanently defeating the interlock. (After inactivation the interlock it is mandatory to take effective precaution measures to prevent unauthorized person from opening the door.)

Switch-side padlock device in combination with M700 acc. to UL508A¹

For asymmetric profile

(only factory provided)

V841/.

Padlock device for base mounting switches to mount padlocks when the switch cabinet is open. (Not for KG10)

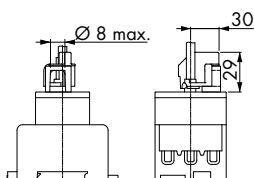

¹ KG Switch types are according UL508 and CSA-22.2 Nr. 14-05 als „disconnect switches for use in motor circuits" approved and only for use in the branch circuit.

MAIN, SAFETY AND MAINTENANCE SWITCH

Padlock device with integrated door clutch for enclosures and control panel

Door clutch with single hole mounting 22 mm, IP 66

Necessary ordering information: Entire mounting depth from switch incl. door clutch.

V840D
V840G
V840G/B

For 2 padlocks with F-handle,, (KG..A)
For 3 padlocks with F-handle,, (KG10B–KG100)
For 3 padlocks with B-handle,, (KG10B–KG100)

A shaft extension is required.

(Lockable at 9:00 o'clock)

The background is available in black, yellow and electro gray. Handle is available in black, red or electro gray.

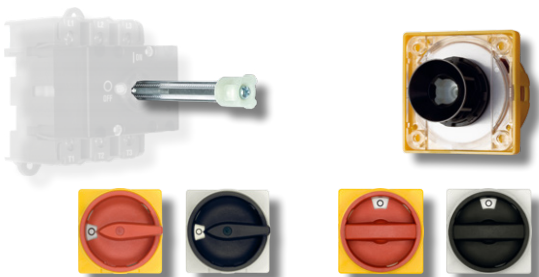

	S min.	A	V840D,V840G	V840G/B
KG10A	30	48	33	-
KG10B	30	64	40,1	29,6
KG20A, KG32A	27,5	48	33	-
KG20B, KG32B	27,5	64	40,1	29,6
KG41B, KG64B	39,5	64	40,1	29,6
KG80, KG100	27,5	64	40,1	29,6

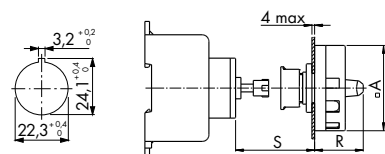

For switch size see page 84.

Door clutch with single hole mounting 22 mm, IP 66

V845

For 4 padlocks (actuation the locking flag from front)

A shaft extension is required.

(Lockable at 9:00 + 12.00 o'clock)

Handle is available in black, yellow and electro gray. Face plate available in yellow or brushed aluminium.

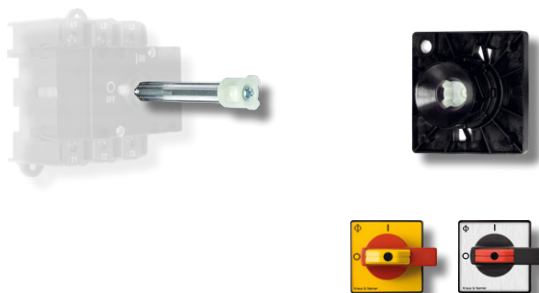

	A	H	S min.
KG10A	48	52	30
KG10B	64	58	26
KG20A, KG32A	48	52	50,5
KG20B, KG32B	64	58	27,5
KG41B, KG64B	64	58	39,5
KG80, KG100	64	58	27,5

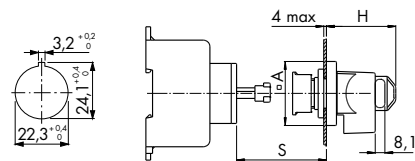

For switch size see page 84.

Centering for door clutches size S1

M600

Inaccuracies in assembling between shaft and drive are, in all 4 directions ± 5 mm, balanced..

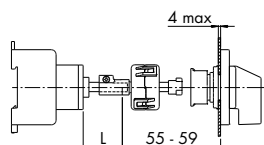

Dimension "L" on request.



Padlock device with integrated door clutch

Door clutch with single hole mounting 22 mm, IP 66/67

Necessary ordering information: Entire mounting depth from switch incl. door clutch.

M810/



M800

M810

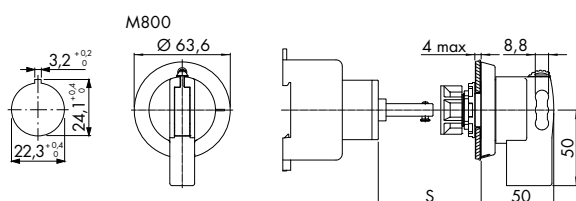

For switch size see page 84.

Handle lockable with padlocks (from KG41B)

With shortened handle (KG41B-KG100)

Additional shaft extension is required.

The M800/M810 provides multiple lock functions. Standard operation: cabinet door is locked in position "I" and can only be opened in position "0". Maintenance operation: After a padlock device is applied (only possible in "0" position) cabinet door and switch are locked. To allow in special cases maintenance under voltage the M800/M810 does have an "override function" which enables to open the cabinet door as well in the "I" position. Further features are the single hole mounting and the centering aid up to ± 3 mm horizontally and ± 5 mm vertically. Maximum 3 padlocks with min. 5 to max. 7.5 mm U-bolt diameter are possible. The maximum free length of shaft is 120 mm

Coloring	Front ring	Handle	Lock bar
M800/ + M810/ A			
A	= black	black	red
B	= yellow	red	yellow

	S min.
KG41B, KG64B	59
KG80, KG100	56
KG125-KG317	56

Switch-side padlock device in combination with M800 and M810 acc. to UL508A ¹

For square profile

(only factory provided)

Padlock device for switches in base mounting for applying a padlock at open cabinet door. (Not for KG10)

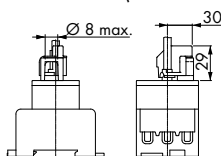

¹ Switch types of the KG series are according to UL508 and CSA-22.2 no. 14-05 approved as "disconnect switches for use in motor circuits" for use in branch circuit only.

Padlock device with integrated door clutch for low installation depth

Door clutch with single hole mounting 22 mm, IP 66

V840E

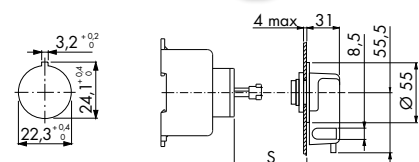
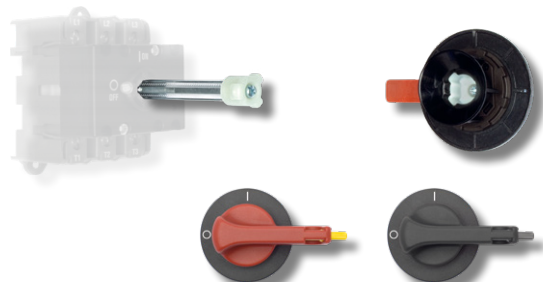

For Switch size dimensions see page 84.

With padlock device

A shaft extension is required

(Lockable at 9:00 o'clock)

Coloring	Plate ring	Handle	Lock bar
V840E/E/ 2			
2	= black	red	yellow
5	= black	black	black

	S min.
KG10B	23
KG20B, KG32B	24,5
KG41B, KG64B	20
KG80, KG100	23
KG125-KG317 ¹	21

¹ Only for ON/OFF switch 3 and 4 pole

MAIN, SAFETY AND MAINTENANCE SWITCH

Padlock device

Sealable V840A

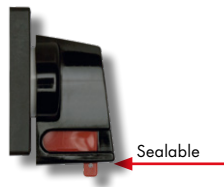

The padlock device is an integral part of the switch handle and can hold 2 padlocks and sealing

Handle available in the colors black, red and electrogray. Faceplate background available in yellow or aluminum brushed. Both positions lockable on request.

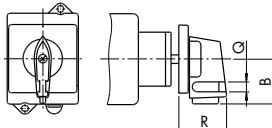

Size	B	C	R	D in mm ^{1,2}	D in mm ³
S0 (V840A/A, .../B, .../E)	31,5	5	32,9	3,5-4,5	
S0 (V840A/C, .../D, .../F)	31,5	5	32,9	3,0-4,0	
S1	40	7	41,6	4,0-6,0	-

¹ Front panel mounting + Cast enclosure | ² Plastic enclosures + Mounting VE2 and VE21 | ³ Single hole mounting

Base mounting 45 mm standard knock-out

V840B



The padlock device is an integral part of the switch handle and can hold 1 padlock (Size VE2 und VE21)

Lock bar accessible from the front
Available in the colors (handle/background) black/gray, gray/gray, red/gray and red/yellow. U-bolt diameter max. 2 x 4,5-6 mm

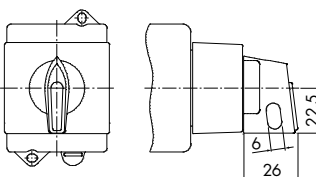

V840H

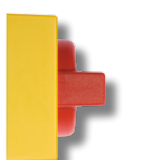

The padlock device is an integral part of the switch handle and can hold 2 padlocks (Size VE2 und VE21)

Lock bar accessible from the front, flush design
Available in the colors (handle/background) black/gray, gray/gray, red/gray and red/yellow. U-bolt diameter max. 2 x 4 mm

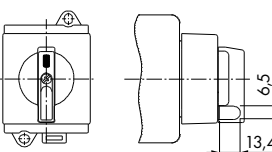

Small sited padlock device

V840K



For 1 padlock Size S00 (U-bolt diameter 3,5-5 mm)

For 2-hole panel mounting and single hole mounting 22 mm (16 mm not possible). Handle in red or black and face plate available in yellow or brushed aluminum.

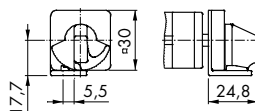

Optional extras for customizing (available only in combination with a switch) – Optional extras



Padlock device

T-handle

V845

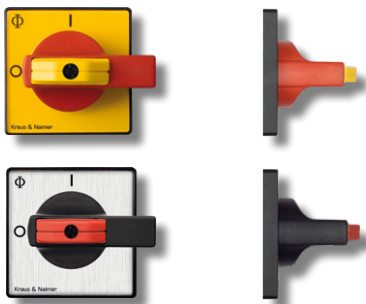

For 4 padlocks (operation of the locking flag from the front)

Handle in the colors black and red available and face plate in the colors yellow and brushed aluminum.

Both positions lockable on request.

Size	A	R	Q
S0	48	51	7,2
S1	64	58	8,1
S2	88	73	9
S3	130	86,5	9

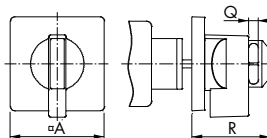

Face plate	Maximum number of padlocks	
	Shackle-Ø	Nr of padlocks
48 x 48	7	2
	3	4
	7,5	3
64 x 64	4	4
	4-8	2-4
88 x 88	4-8,5	2-4

F-handle

V840D

V840G
V840F/F



For 2 padlocks Size S0 (48 x 48)

For 3 padlocks Size S2 (88 x 88)

For 3 padlocks Size S1 (64 x 64)

For 4 padlocks Size S1 (64 x 64)

Padlock device with integrated F-handle.
Handles available in the colors black, red and electrogray.
Background available in black, yellow and electrogray.

V840D Size S0 (48 x 48)

V840D Size S2 (88 x 88)
V840G, V840F/F

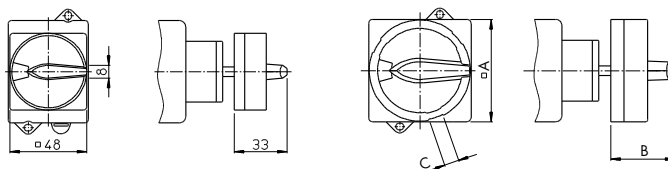

	A	B	C
V840D	88	49,3	10
V840G	64	40,1	9,2
V840F/F	64	40,1	9,2

B-handle

V840G/B

V840F/B

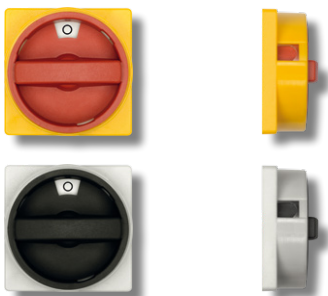

For 3 padlocks Size S1 (64 x 64)

For 4 padlocks Size S1 (64 x 64)

Padlock device with integrated B-handle.
Handles available in the colors black, red and electrogray.
Background available in black, yellow and electrogray.

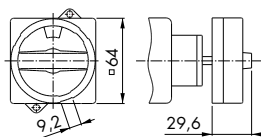

Optional extras for customizing (available only in combination with a switch) — **Optional extras**

Mounting E, ON/OFF switch 3- and 4-pole

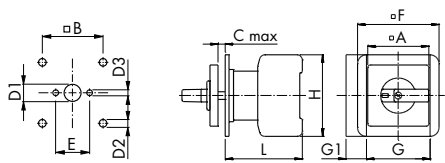

Drill hole pattern face plate KG10A-KG100C

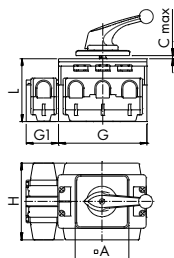

KG125-KG315

KG10A-KG100C	Switch							Drill hole pattern				
	A	C	F	G	G1 ¹	H	L	B	E	D1	D2	D3
KG10A	48	4	48	48		50	48,2	36		11-15	5	
KG10B	64	4	64	48		50	57,2	48		11-15	5	
KG20, KG32	30	4		42	13,5	54	50,8		20	8-11		3,2
KG20A, KG32A	48	4	48	42	13,5	54	53,8	36		10-15	5	
KG20B, KG32B	64	4	64	42	13,5	54	53,8	48		10-15	5	
KG41, KG64	48	4	64	50	16	64	60,5	36		10-15	5	
KG41B, KG64B	64	4	64	50	16	64	60,5	48		10-15	5	
KG80, KG100	64	4	70	70	22	80	70,6	48		10-15	5	
KG80C, KG100C	88	4	88	70	22	80	70,6	68		10-15	6	

KG125-KG315	Switch						Drill hole pattern		
	A	C	G	G1 ¹	H	L	B	D1	D2
KG125, KG160	88	5,5	112	38	108	96	68	13-17	6
KG210, KG250, KG315	88	5,5	145	52,5	126	103	68	13-17	6

¹ For ON/OFF switch 4-pole

Mounting E, ON/OFF switch 6- and 8-pole and ON/OFF 3- and 4-pole

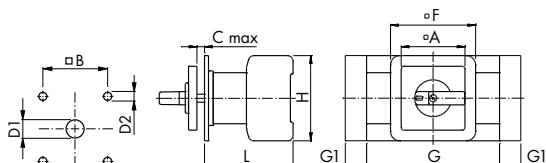

Drill hole pattern face plate KG10A-KG100C

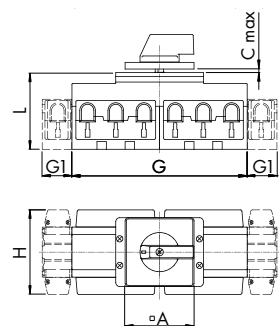

KG125, KG160

KG10A-KG100C	Switch								Drill hole pattern		
	A	C	F	G	G1 ²	H	L 6-p.	L 8-p.	B	D1	D2
KG10A	48	4	48	48		50	57,7	67,2	36	11-15	5
KG10B	64	4	64	48		50	66,7	76,2	48	11-15	5
KG20A, KG32A	48	4	48	84	13,5	54	61,3		36	10-15	5
KG20B, KG32B	64	4	64	84	13,5	54	61,3		48	10-15	5
KG41B, KG64B	64	4	64	100	16	64	66,5		48	10-15	5
KG80, KG100	64	4	70	140	22	80	81,8		48	10-15	5
KG80C, KG100C	88	4	88	140	22	80	81,8		68	10-15	6

KG125, KG160	Switch						Drill hole pattern		
	A	C	G	G1 ²	H	L	B	D1	D2
KG125, KG160	88	5,5	224	38	108	98	68	13-17	6

² For ON/OFF switch 8-pole and ON/OFF switch 4-pole

Mounting FT1, FT2, ON/OFF switch 3- and 4-pole

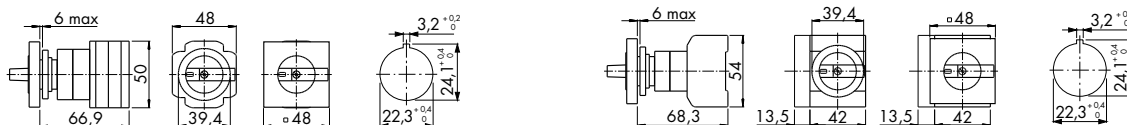

KG10A

FT1

FT2

KG20A, KG32A

FT1

FT2

Mounting FT1, FT2, ON/OFF switch 6- and 8-pole and ON/OFF switch 3- and 4-pole

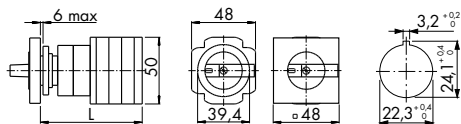

KG10A

FT1

FT2

	L
ON/OFF switch 6- and ON/OFF switch 3-pole	76,4
ON/OFF switch 8- and ON/OFF switch 4-pole	85,9



Dimensions for base switch KG – Mounting VE, VE1, VE2, VE21 Additional length for camoperated auxiliary contacts on page 73.

Mounting VE + VE1, ON/OFF switch 3- and 4-pole

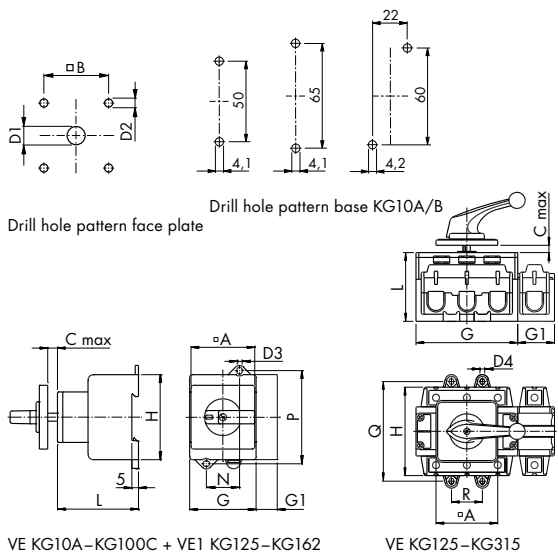

KG10A–KG100C	Switch						Drill hole pattern					
	A	C	G	G1 ¹	H	L	B	D1	D2	N	P	D3
KG10A	48	12	48		50	49,2	36	8-15	5	2	2	2
KG10B	64	29	48		50	56,2	48	10-15	5	2	2	2
KG20A, KG32A	48	12	42	13,5	54	50	36	8-15	5	22	60	4,1
KG20B, KG32B	64	13,5	42	13,5	54	50	48	10-15	5	22	60	4,1
KG41, KG64	48	12	50	16	64	61	36	10-15	5	25	70	4,1
KG41B, KG64B	64	13,5	50	16	64	61	48	10-15	5	25	70	4,1
KG80, KG100	64	13,5	70	22	80	68	48	10-15	5	25	90	5,2
KG80C, KG100C	88	13,5	70	22	80	68	68	10-15	6	25	90	5,2

KG125–KG315	Switch						Drill hole pattern					
	A	C	G	G1 ¹	H	L ³	B	D1	D2	Q	R	D4
KG125, KG160	88	5,5	112	38	108	96	68	13-17	6	118-122	36	6,4
KG210, KG250, KG315:88	5,5	145	52,5	126	103		68	13-17	6	140-144	44	6,4

¹ For ON/OFF switch 4-pole ² KG10A/B separate drawing on the left |
 ³ Additional length for mounting VE1 = 7,5

Mounting VE + VE1, ON/OFF switch 6- and 8-pole and Double-throw switch 3- and 4-pole

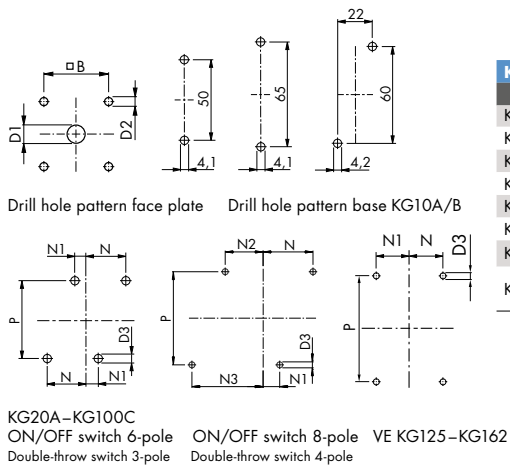

KG10A–KG160	Switch							Drill hole pattern									
	A	C	G	G1 ⁴	H	L ³ 6-p.	L ³ 8-p.	B	D1	D2	D3	N	N1	N2	N3	P	
KG10A	48	12	48		50	58,7	68,2	36	8-15	5	2	2	2	2	2	2	
KG10B	64	29	48		50	65,7	75,2	48	10-15	5	2	2	2	2	2	2	
KG20A, KG32A	48	12	84	13,5	54	57,5		36	8-15	5	4,1	32	10	23,5	45,5	60	
KG20B, KG32B	64	13,5	84	13,5	54	57,5		48	10-15	5	4,1	32	10	23,5	45,5	60	
KG41B, KG64B	64	13,5	100	16	64	67		48	10-15	5	4,1	37,5	12,5	28,5	53,5	70	
KG80, KG100	64	13,5	140	22	80	79,2		48	10-15	5	5,2	47,5	22,5	44,5	69,5	90	
KG80C, KG100C	88	13,5	140	22	80	79,2		68	10-15	6	5,2	47,5	22,5	44,5	69,5	90	
KG125, KG162	88	16	224	38	108	93		68	13-17	6	6,4	38	38			118-122	

² KG10A/B separate drawing on the left | ³ Additional length for mounting VE1 = 7,5
 ⁴ For 8-pole and ON/OFF switch 4-pole

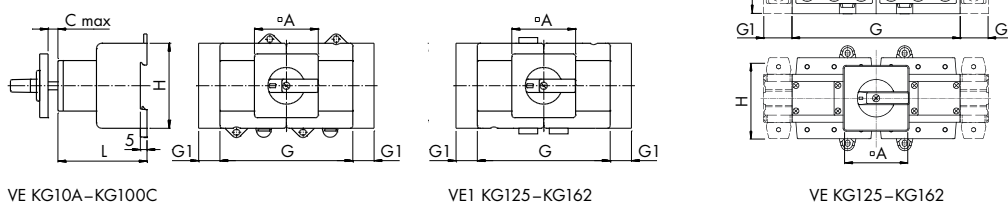

Mounting VE21 and VE2, ON/OFF switch 3- and 4-pole

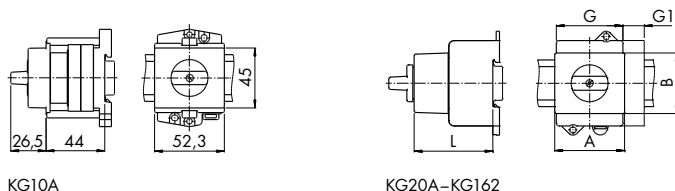

KG20A–KG162	A	B	G	G1 ¹	L
KG20A, KG32A	43,7	45,4	42	13,5	56,5
KG41, KG64	52,4	45,4	50	16	56,5
KG80, KG100	70	45	70	22	65
KG125–KG162	112	45	112	38	98

¹ For ON/OFF switch 4-pole

Mounting VE21 and VE2, ON/OFF switch 6- and 8-pole, Double-throw switch 3- and 4-pole

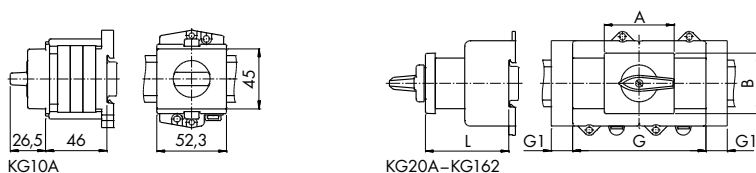

KG20A–KG162	A	B	G	G1 ¹	L
KG20A, KG32A	43,7	45,4	84	13,5	64
KG41B, KG64B	105,4	45,4	100	16	62,5
KG80, KG100	70	45	140	22	76,2
KG125–KG162 ²	112	45	224	38	101,5

¹ For ON/OFF switch 8-pole and Double-throw switch 4-pole
 ² For ON/OFF switch 3- and 4-pole

MAIN, SAFETY AND MAINTENANCE SWITCH

Detail Selection KG switches

The switches described in this chapter comply with regulations of IEC 60947-3, EN 60947-3, VDE 0660 Part 107, IEC 60204, EN 60204 and VDE 0113. They therefore meet all the requirements for disconnectors, switch disconnectors, main switches and repair switches.

Electrical data		KG10 KG10A KG10B	KG20 KG20A KG20B	KG32 KG32A KG32B	KG41 KG41B	KG64 KG64B	KG80 KG80C	KG100 KG100C	KG125 KG126 KG127	KG160 KG161 KG162	KG210 KG211 KG212	C200-4	KG250 KG251 KG252	KG315 KG316 KG317	C316		
Rated values																	
Insulation voltage U_i	IEC/VDE ¹ Disconnectors conditions ¹	V	690	690	690	690	690	690	690	1000 ²	1000 ²	1000 ²	690	1000 ²	1000 ²	1000	
	USA/Kanada	V	300	600	600	600	600	600	600	600	600	600	-	600	600	600	
	CEE/NEMKO	V	400	500	500	500	500	500	500	-	-	-	-	-	-	-	
Rated impulse withstand voltage U_{imp}^1		kV	4	6	6	6	6	6	8	8	8	6	8	8	8		
Thermal current	IEC/VDE $I_{u, open} = I_{th}$	A	20	25	32	40	63	80	100	125	160	200	200	250	315	315	
	USA/Canada $I_{th, e}$ enclosed	A	20	25	32	40	63	80	100	125	160	200	200	250	315	315	
	USA/Canada ON/OFF function	A	20	25	32	40	60	80 ³	100 ³	150 ³	200 ³	-	250 ³	300 ³	240		
Breaking capacity	220 V / 240 V	A	120	180	220	300	350	560	700	800	900	1300	1100	1600	1800	2000	
	380 V / 440 V	A	120	180	220	300	350	560	650	750	850	1100	1100	1380	1650	2000	
	660 V / 690 V	A	80	125	135	150	190	200	280	340	340	400	490	400	400	335	
AC-21A	1-phase, 2-pole	A	120														
	IEC/VDE Disconnecter-rated operational current I_e	A	20	25	32	40	63	80	100	125	160	200	200	250	315	315	
Rated utilization category																	
AC-3	Direct-on-line Starting	220 V / 240 V	kW	2,2	4	5,5	7,5	11	15	18,5	22	30	37	22	37	45	37
		380 V / 440 V	kW	3,7	5,5	7,5	11	18,5	22	30	37	45	55	37	55	75	55
		500 V	kW	3,7	5,5	7,5	15	22	30	37	45	55	75	37	75	90	55
		690 V	kW	3,7	5,5	7,5	11	15	18,5	22	30	37	40	30	40	45	37
AC-23A, AC-23B	Frequent switching of motors or other high inductive loads	220 V / 240 V	kW	3	5,5	5,5	7,5	11	18,5	22	30	30	37	37	37	55	75
		380 V / 440 V	kW	5,5	7,5	11	15	22	30	37	45	55	75	75	90	110	132
		500 V	kW	5,5	7,5	11	18,5	30	37	45	55	75	90	90	110	132	132
		690 V	kW	5,5	7,5	11	15	18,5	22	30	37	37	45	55	45	45	37
Ampere-Rating	Resistive or low inductive loads	USA/Canada ⁴ 600 V ON/OFF	A	20 ⁸	25	30	40	60	80 ³	100 ³	150 ³	200 ³	200 ³	-	250 ³	300 ³	240
		600 V 1-0-2	A	20 ⁸	25	30	40	60	80 ³	100 ³	125 ³	160 ³	-	-	-	-	-
DOL-Rating	Standard motor load (similar to AC-3)	USA/Canada ⁴ 120 V	HP	1	1,5	2	3	5	7,5	10	15	20	25	-	30	40	30
		240 V	HP	2	3	5	7,5	10	20	25	30	40	50	-	60	75	75
		480 V	HP	5	10	15	20	40	50	60	60	75	75	-	75	100	75
		600 V	HP	5	10	15	20	50	50	60	60	75	75	-	75	100	60
Power loss per pol at I_u	Resistance to vibration ⁷	Resistance to shock ⁷	W	0,9	0,7	1,1	1	2,2	1,7	2,4	3,1	5	5	6,7	8	12,7	17
			C	A	A	A	A	A	A	C	C	C	C	C	C	C	C
			C	B	B	B	B	B	B	C	C	C	C	C	C	C	C
Short circuit protection																	
Max. fuse size (gL-Characteristic)	A	20	35	35	50	63	80	100	125	160	200	200	250	315	315		
Rated short-time withstand current [1 Sec. current]	A	130	350	430	500	580	1600	1850	2500	3000	4000	2000	4600	5800	4200		
Rated conditional short-circuit current I_{cc} (kA)	kA	2	15	15	7,5	15	15	15	30	30	30	5	30	15	5		
Cut-off current I_c (kA)	kA	1,45	3,5	3,5	3,6	5,1	6,1	7,6	12,5	12,9	16	-	19	17,6	8,5		
Joule Integral I^2t (kA ² s)	kA ² s	1,95	5,62	5,62	11,05	17,57	31,75	60,99	100,03	102,7	220	-	460	918,12	1080		
Max. permissible wire gage (Use Copper wire only)																	
Single-core or stranded wire	mm ²	2,5	6	6	16	16	50	50	95	95	185	95 ⁹	185	185	185 ⁹		
	AWG	12	10	10	6	6	1/0	1/0	3/0	3/0	-	-	-	-	-		
	MCM	-	-	-	-	-	-	-	-	-	350	-	350	350	350		
Flexible wire without sleeve	mm ²	2,5	4	4	10	10	35	35	70	70	150	95 ⁹	150	150	150 ⁹		
	AWG	12	10	10	6	6	2	2	2/0	2/0	-	-	-	-	-		
	MCM	-	-	-	-	-	-	-	-	-	300	-	300	300	300		
Flexible wire sleeving in accordance with DIN 46228	mm ²	2,5	4	4	10	10	35	35	70	70	120	-	120	120	-		
Cable lug or track must accept	Connection screw	mm	-	-	-	-	-	-	M10x	M10x	M12x	M8x	M12x	M12x	M12x		
	Max. width	mm	-	-	-	-	-	-	20	20	20	6	20	20	20		
	Max. width with protective cover	mm	-	-	-	-	-	-	20	20	25	-	25	25	25		
Max. ambient temperature⁶																	
open at 100 % I_u/I_{th}	50 °C during 24 hours with peaks up to 55 °C																
enclosed at 100 % $I_{th,e}$	35 °C during 24 hours with peaks up to 40 °C																

¹ Valid for lines with common neutral termination, overvoltage category III, pollution degree 3 Values for other supply systems on request | ² Suitable for no load switching applications (AC-20A) above 690 V. | ³ Valid when connected with wire rated for 75 °C. | ⁴ International standards and approvals refer to Page 204 | ⁵ The values after the slash effective for the 6- and multi-pole switch. | ⁶ Storage temperature: -40 °C bis 85 °C (at temperatures below -5 °C, no impact load is permitted) | ⁷ A: min. 4 g, 2-100 Hz, 1,6 mm. B: min. 6 g, 6 ms. C: on request. | ⁸ Max. 277 V | ⁹ Connection with cable lug

kW 3
kW 5,5
kW 5,5
kW 5,5



Auxiliary contacts															
Electrical data with			KG10	KG20	KG32	KG41	KG64	KG80	KG100	KG125	KG160	KG210	C2004	KG250	KG315
			KG10A	KG20A	KG32A	KG41B	KG64B	KG80C	KG100C	KG126	KG161	KG211		KG251	KG316
			KG10B	KG20B	KG32B					KG127	KG162	KG212		KG252	KG317
Rated values															
Insulation voltage U_i^1	IEC/VDE	V	690	500					690				690	690	690
Rated impulse withstand voltage U_{imp}^1	USA/Canada	V	300	600					600				-	600	600
		kV	4	6					6				6	6	6
Thermal current	IEC/VDE USA/Canada	I_{th} open = I_{th}	A	20	10				16				16	16	16
		I_{th} enclosed	A	20	10				10				-	10	10
AC-21A	IEC/VDE	Switching v. resistive load m. ger. OB load	A	20	10				16				16	16	16
AC-15	IEC/VDE Operational Current I_e	220 V/240 V	A	6	2,5				6				6	6	6
		380 V/440 V	A	4	1,5				3				4	3	4
		500 V	A	-	1				1,5				1,5	1,5	-
Pilot duty Heavy	USA/Canada		A300	A600				A600					-	A600	A600
Current Rating	USA/Canada	A	20 ⁸	10				10					-	10	10
Short circuit protection (Max. fuse size [gL-Characteristic] Rated short-time withstand current [1 Sec. current])															
Max. fuse size (gL-Characteristic)			A	20	10				16				16	16	16
Max. permissible wire gage (Use Copper wire only)															
Single-core or stranded wire		mm ²	2,5	1,5				2,5				2,5	2,5	2,5	2,5
		AWG	12	14				12				-	12	12	14
Flexible wire without sleeve		mm ²	2,5	1,5				2,5				2,5	2,5	2,5	2,5
		AWG	12	16				14				-	14	14	14
Flexible wire sleeving in accordance with DIN 46228		mm ²	2,5	1				2,5				2,5	2,5	2,5	2,5
Max. ambient temperature ⁶															
open at 100 % I_u/I_{th}			50 °C during 24 hours with peaks up to 55 °C												
enclosed at 100 % I_{th}			35 °C during 24 hours with peaks up to 40 °C												

kw 3
kw 5,5
kw 5,5
kw 5,5

Electrical Data

Auxiliary contacts H-bridge Gold ¹⁰															
Electrical data with			KG10	KG20	KG32	KG41	KG64	KG80	KG100	KG125	KG160	KG210	C2004	KG250	KG315
			KG10A	KG20A	KG32A	KG41B	KG64B	KG80C	KG100C	KG126	KG161	KG211		KG251	KG316
			KG10B	KG20B	KG32B					KG127	KG162	KG212		KG252	KG317
Rated values, short circuit protection, max. permissible wire gage, max. permissible wire gage															
See chapter CONTROL SWITCH at the Switch types				CA4-1					CAD11				CAD4-1	CAD11	CA10

¹ Valid for lines with grounded common neutral termination, overvoltage category III, other values on request. | ⁶ Storage temperature: -40 °C bis 85 °C (at temperatures below -5 °C, no impact load is permitted) | ⁸ Max. 277 V | ¹⁰ KG20B and KG32B instead of H-bridge contact with multipoint bearing, C316 Goldcontact mit point bearing.



Fast boot <10 sec.

Fanless

**Ruggedize, compact design
(resistant to scratches, UV, chemicals)**

Fast writing to disc 50 MByte / sec.

FRAM 64 kByte

Real Time Clock

Long life cycle product

Low power consumption

Virtual Network Client and Server

Power supply 10 to 32 VDC

First step into IIoT compatibility

- Multiple protocols
- OPC UA Server and Client
- Up to 3 Ethernet ports with different PHY
- Wide range of applications as gateway, powerful HMI, PLC (Codesys V3) or secure router
- Wide temperature range
- Ideal device for use in data-intensive or complex IIoT applications
- Expandable with local interfaces and IO's

KN-C 700 T-Series

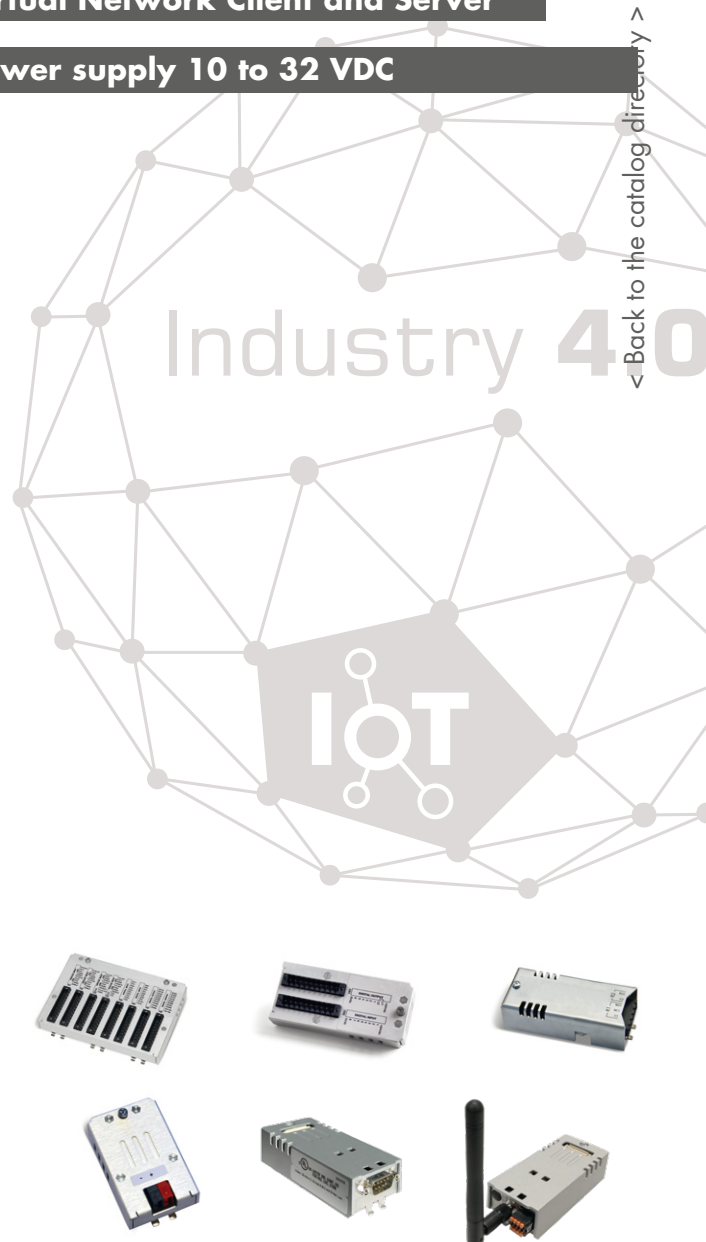

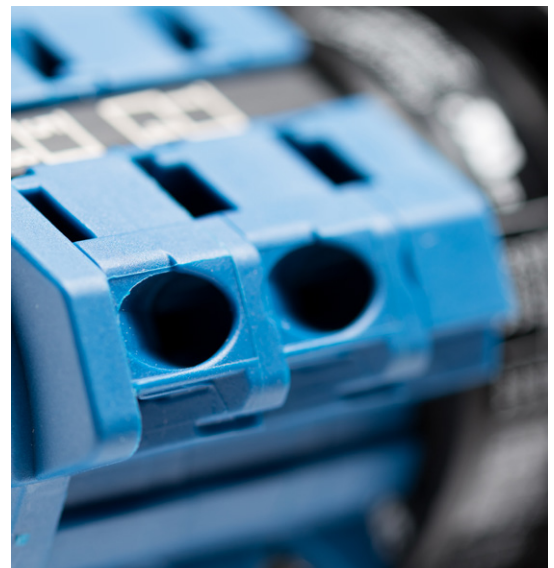

< Back to the catalog directory >

- ▶ Control Switch
- ▶ Load Switch

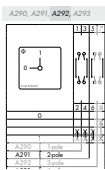

Next >

- Ordering example -

1. Switch type	2. Switch function	3. Mounting	4. Optional extras (as sub item)
Kind of switch and electrical capacity	Switch function	Mounting of switch	
Page 92 ff.	100 ff.	122 ff.	134 ff.
e.g. CH10	A292	FT2	CH10 A292*FT2 SO V750D/3G
			

- Ordering example if a replacement is required -
The most important data you should know about ordering, in case of replacement.

Labels until 2019

Labels from 2020

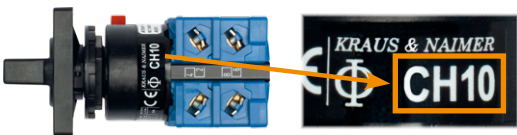
1. 

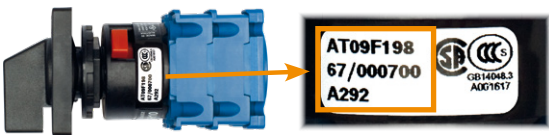
2. 



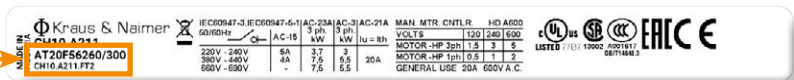





Should details not be available or incomplete, send us significant pictures of the switch and the description of the electrical properties according to form on page 207.

Switch type-Overview

Size	Face plate (mm)	Switch type	Switch angle options	Max. Number of stages
S00	30 x 30	CG4, CG4-1, CGD4-1 CA4, CA4-1, CAD4-1 CH6	30°, 45°, 60°, 90° 30°, 45°, 60°, 90° 30°, 45°, 60°, 90°	8 9 5
S0	48 x 48	CH10-CH16, CG8, CA10-CA25, CAD11, DH10, DH11	30°, 45°, 60°, 90°	12
S1	64 x 64	CH10B-CH16B, CG8B, CA40-CA63, DH10B, DH11B	30°, 45°, 60°, 90°	12
S2	88 x 88	C80, C125, C200-4, CA40C-CA63C	20°, 30°, 45°, 60°, 90°	12
S3	130 x 130	C315	30°, 45°, 60°, 90°	12

Sizes

				
S00 30 x 30	S0 48 x 48	S1 64 x 64	S2 88 x 88	S3 130 x 130

Design features and contact systems

Cam switches are ideal control and load switches. Different contact systems and different contact materials also allow their use in electronic circuits as well as in aggressive environmental conditions. The basic building block of all switches is the stage, which is equipped with 1 or 2 contacts. A contact can be a normally open or normally closed contact.

During switching, they may also overlap, advance, or lag. The contacts are operated via the detent mechanism; latching and touch functions are possible. All switches up to and including CA63 are supplied with the terminals open and finger proof according to EN 50274 and BGV A3. These have captive plus/minus terminal screws and integrated screwdriver guides facilitate wiring.

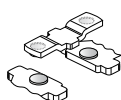

Standard double break with rigid contact bridge and silver point contacts.

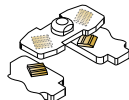

CG4, CG4-1
CA4, CA4-1

High contact reliability due to multiple cross-point contacts, C.4 with 0.5 μ and C.4-1 with 5 μ gold plating.

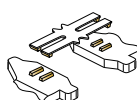

CH11, CAD11
DH11

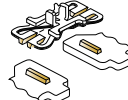

CGD4-1
CAD4-1

High contact reliability through H-bridge with "cross-wire" contact system. Contacts with gold plating for use even at low voltage, low current (compatible with electronic signals) as well as aggressive environmental influences.



Configurable

1. Switch type / Electrical data

Quick selection switch type / Electrical data	92
Detail selection switch type	94
International standards and approvals	204

2. Switch functions / Electrical data

ON/OFF switch, double-throw switch	100
Group switch	102
Code switch with binary coding, multi-step switch without "OFF"-position	103
Multi-step switch with "OFF"-position	104
Voltmeter switch, ammeter switch, volt-ammeter switch	105
Control switch, control and alarm switch, motor reversing switch	106
Motor control switch, star-delta-switch, start and run switch	107
Switch functions (numerically sorted)	108
Switch functions details	109
Form for customized switch function and face plates	206

3. Mounting

2- and 4-hole panel mounting	122
Single hole mounting 16/22/30 mm	123
Front panel mounting using larger face plate and handle, Front panel mounting with heavy duty latching and metal shaft	124
Front panel mounting with round shafts or mosaic mounting, Front panel mounting with protective cover	125
Base mounting	126
Dimension L, Dimensions of plug-in connection and bolt terminals	129
Plastic enclosures	131
Aluminum enclosures	131
Enclosures (crude)	132

4. Optional extras

Key-lock devices	134
Front built-in lights, trip Indicator	142
Control and indicator Device	143
Stop and go device, interlock between switches, Auxiliary contacts	144
Push-pull interlocks	145
Push button interlock, Bayonet/switch coupling	146
Electromechanical interlock, heavy duty applications	147
Electromechanical trip device (shunt-trip), lockout-relay	148
Disconnecter and Main-/Emergency switches with under-voltage	149
Spring return latching mechanism, uni-directional interlock, slip and ratchet clutch, motor drive	150
Terminal covers, PE- and N-terminals, special drives	151
Door clutches and padlock devices	152
Terminal lug, shaft extensions with asymmetric and square profile	156
Protective Covers (switch rear side)	157
Accessories single hole mounting, mounting screws, blank covers	158
Face plates and rectangular add-on face plates, handles, change of handle position	160

Complete items

ON/OFF switch, double-throw switch without "OFF"-position	164
Double-throw switch with "OFF"-position	165
Multi-step switch	166
Volt-Ammeter switch	168
Control switch – start switch and stop-start switch, code switch with binary coding	169











CONTROL SWITCHES AND LOAD SWITCHES

Switch type / Electrical data									
Type	Thermal current (lu/lth)	Rating 380 V–440 V		Face plate size	Standard type	Contact with gold plating	Screwdriver		Enclosed contact chambers
		AC-23A	AC-3				back	side	
 CG4	10 A	3 kW	2,2 kW	□ 30 mm S00	●				
CG4-1	10 A	3 kW	2,2 kW	□ 30 mm S00		●			
CGD4-1	5 A			□ 30 mm S00		● H-bridge			
CAD4-1	5 A			□ 30 mm S00		● H-bridge			
CA4	10 A	3 kW	2,2 kW	□ 30 mm S00					
CA4-1	10 A	3 kW	2,2 kW	□ 30 mm S00		●			
CH6	20 A	7,5 kW	5,5 kW	□ 30 mm S00					
 CH10	20 A	7,5 kW	5,5 kW	□ 48 mm S0	●				
CH10B	20 A	7,5 kW	5,5 kW	□ 64 mm S1					
CG8	20 A	7,5 kW	5,5 kW	□ 48 mm S0					
CG8B	20 A	7,5 kW	5,5 kW	□ 64 mm S1					
 CA10 ¹	20 A	7,5 kW	5,5 kW	□ 48 mm S0					
CA10B ¹	20 A	7,5 kW	5,5 kW	□ 64 mm S1					
CA11 ¹	20 A	7,5 kW	5,5 kW	□ 48 mm S0					
CA11B ¹	20 A	7,5 kW	5,5 kW	□ 64 mm S1					
CH11	6 A			□ 48 mm S0		● H-bridge			
CAD11	6 A			□ 48 mm S0		● H-bridge			
 DH10	16 A	5,5 kW	3,7 kW	□ 48 mm S0					●
DH10B	16 A	5,5 kW	3,7 kW	□ 64 mm S1					●
DH11	6 A			□ 48 mm S0		● H-bridge			●
DH11B	6 A			□ 64 mm S1		● H-bridge			●
CH16	25 A	11 kW	7,5 kW	□ 48 mm S0	●				
 CH16B	25 A	11 kW	7,5 kW	□ 64 mm S1					
CA20	25 A	11 kW	7,5 kW	□ 48 mm S0					
CA20B	25 A	11 kW	7,5 kW	□ 64 mm S1					
 CA25	32 A	15 kW	11 kW	□ 48 mm S0	●				
CA25B	32 A	15 kW	11 kW	□ 64 mm S1					



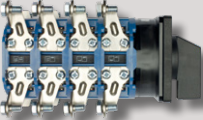

¹ UL: CA10/CA10B U_i=300 V, CA11/CA11B U_i=600 V

Quick selection switch type

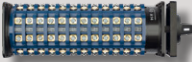

Switch type / Electrical data									
Type	Thermal current (lu/lth)	Rating 380 V-440 V		Face plate size	Standard type	Contact with gold plating	Screwdriver		Enclosed contact chambers
		AC-23A	AC-3				back	side	
 CA40 CA40C	40 A	18,5 kW	15kW	<input type="checkbox"/> 64 mm S1 <input type="checkbox"/> 88 mm S2	●				
CA50 CA50C	50 A	22 kW	18,5 kW	<input type="checkbox"/> 64 mm S1 <input type="checkbox"/> 88 mm S2	●				
CA63 CA63C	63 A	30 kW	18,5 kW	<input type="checkbox"/> 64 mm S1 <input type="checkbox"/> 88 mm S2	●				
 C80	115 A	45 kW	30 kW	<input type="checkbox"/> 88 mm S2	●				
C125	150 A	75 kW	37 kW	<input type="checkbox"/> 88 mm S2	●				
 C200-4	200 A	75 kW	37 kW	<input type="checkbox"/> 88 mm S2	●				
 C315	315 A	132 kW	55 kW	<input type="checkbox"/> 130 mm S3	●				
 CA44 CH...4/-6 DH...4/-5	bis 25 A			<input type="checkbox"/> 30 mm S00 <input type="checkbox"/> 48 mm S0 <input type="checkbox"/> 64 mm S1					Switches with quick connectors on request. For switch size dimensions see page 129.

Switches for particular case and DC switches

Type	Thermal current (lu/lth)		
 A... AD...	up to 25 A	Control switch from 13 switch positions and up to 48 contacts	
 L...	up to 2400 A	Load break switches from 350 up to 2400 A	
 ..R	up to 25 A	Control switch with ring type terminal	Page 172 ff.
 DK...	up to 16 A	Control switch to push and rotate	
 G20 G20S	up to 20 A DC	DC switch up to 1000 V / 20 A with snap on latching and knife contacts. Also suitable for low voltage and low current application.	

CONTROL SWITCHES AND LOAD SWITCHES

Switch type according IEC 60947-3, EN 60947-3, VDE 0660 part 107 (USA/Canada next double page)

Electrical data		CG4 CA4	DH10/B	CH6 CH10/B	CG8/B CA10/B CA11/B	CH16/B	CA20/B	CA25/B			
Rated values											
Thermal current I_U/I_{th}		A	10	16	20	20	25	25	32		
Insulation voltage U_i ¹		V	440	690	690	690	690	690	690		
Rated impulse withstand voltage U_{imp}		kV	4	6	6	6	6	6	6		
Rated operational current I_e											
AC-21A	Switching of resistive loads, including moderate overloads	A	10	16	20	20	25	25	32		
AC-22A	Switching of combined resistive or low inductive loads, including moderate overloads	220 V–500 V	A	10 ^B	-	20 ^{E/D}	-	-	-		
		220 V–440 V	A	10	-	20 ^C	25	25	32		
		660 V–690 V	A	-	-	16	20 [16 ^C]	25	25	32	
		500 V	A	-	-	20	20 ^C	25	-	-	
AC-15	Switching of control devices, contactors, valves etc.	110 V	A	2,5 ^A	5	5	6 ^C	8	-		
		220 V–240 V	A	2,5	5	5	5	8	8	12	
		380 V–440 V	A	1,5	3	4	4	5	5	6	
Rated utilization category											
AC-3	Direct-on-line starting	3-phase, 3-pole	220 V–240 V	kW	1,5	2,2	3	3	4	4	5,5
			380 V–440 V		2,2	3,7	5,5	5,5	7,5	7,5	11
			500 V		-	3,7	5,5	5,5	7,5	7,5	11
		660 V–690 V	-	3,7	5,5	5,5	7,5	7,5	11		
		1-phase, 2-pole	110 V–120 V	0,3	0,37	0,6	0,6	1,5	1,5	2,2	
			220 V–240 V	0,55	1,1	2,2	2,2	3	3	4	
380 V–440 V	0,75		2,2	3	3	3,7	3,7	5,5			
500 V	-	-	3 ^{F/G}	3 ^{F/G}	4	-	-				
660 V–690 V	-	-	3 ^{F/G}	3 ^{F/G}	3,7	-	-				
AC-4	Direct-on-line starting, reversing, plugging and inching	3-phase, 3-pole	220 V–240 V	kW	0,37	-	0,55	0,55	1,5	1,5	2,5
			380 V–440 V		0,55	-	1,5	1,5	3	3	5,5
			500 V		-	-	1,5	1,5	3	3	5,5
		660 V–690 V	-	-	1,5	1,5	3	3	5,5		
		1-phase, 2-pole	110 V–120 V	0,15	-	0,3	0,3	0,45	0,45	0,75	
			220 V–240 V	0,25	-	0,75	0,75	1,1	1,1	1,5	
380 V–440 V	0,5		-	1,5	1,5	2,2	2,2	3			
AC-23A	Frequent switching of motors or other high inductive loads	3-phase, 3-pole	220 V–240 V	kW	1,8	3	3,7	3,7	5,5	5,5	7,5
			380 V–440 V		3	5,5	7,5	7,5	11	11	15
			500 V		-	5,5	7,5	7,5	11	11	15
		660 V–690 V	-	4	7,5	7,5	11	11	15		
		1-phase, 2-pole	110 V–120 V	0,37	0,55	0,75	0,75	1,5	1,5	2,2	
			220 V–240 V	0,75	1,5	2,5	2,5	3	3	4	
380 V–440 V	1,1		2,5	3,7	3,7	5,5	5,5	7,5			
500 V	-	-	4 ^{F/G}	4 ^{F/G}	5,5	-	-				
660 V–690 V	-	-	4 ^{F/G}	4 ^{F/G}	5,5	-	-				
Breaking capacity											
		220 V–240 V	A	50	-	150	200	280			
		380 V–440 V	A	50	-	150	200	250			
		660 V–690 V	A	-	-	80	125	150			
Power loss, resistance to vibration, resistance to shock											
Power loss per pol at I_U		W	0,4	-	1,4	0,9 (0,8 CG8/B)	2,3	0,9	0,7		
Resistance to vibration		min. 4 g, 2-100 Hz, 1,6 mm (CG-, CH-, DH-Switch on request)									
Resistance to shock		min. 5 g, 6 ms (CG-, CH-switch 30 ms, DH-Switch on request)									
Short circuit protection											
Max. fuse size		gG-Characteristic		A	10	16	25	25	35	35	35
Rated short-time withstand current		(1 sec. current)		A	60 (90 ^A)	120	200	140	250	280	480
Max. permissible wire gage (use Copper wire only)											
		2 x		2 x	2 x	2 x	2 x	2 x	2 x	2 x	
Single-core or stranded wire		mm ²		1,5	2,5	4	2,5	2,5	4	4	6
Flexible wire		mm ²		1,5 ^B	2,5	2,5	2,5	2,5	2,5	4	4
Flexible wire sleeving in accordance with DIN 46228		mm ²		1	1,5	2,5	2,5	2,5	2,5	2,5	4
Max. ambient temperature ^{2,3}											
open at 100 % I_U/I_{th}		55 °C during 24 hours with peaks up to 60 °C									
enclosed at 100 % I_{th}		35 °C during 24 hours with peaks up to 40 °C									

¹ Valid for lines with common neutral termination, overvoltage category III, pollution degree 3 Values for other supply systems On request | ² For electromagnetic optional extras see additional data in the chapter **Optional Extras**. | ³ Storage temperature: -40 °C to 85 °C (in case of temperature below -5 °C no shock load permissible). | ⁴ 90° only in Size S0
^A Only applies to CG4 | ^B Only applies to CA4 | ^C Only applies to CG8/B | ^D Only applies to CA11/B | ^E Only applies to CA10/B | ^F Only applies to CH10/B | ^G Only applies to CH6



Switch type according IEC 60947-3, EN 60947-3, VDE 0660 part 107 (USA/Canada next double page)												
Electrical data				CA40 CA40C	CA50 CA50C	CA63 CA63C	C80	C125	C200-4	C315		
Rated values												
Thermal current I_U/I_{th}				A	40	50	63	115	150	200	315	
Insulation voltage U_i ¹				V	690	690	690	690	690	690	690	
Rated impulse withstand voltage U_{imp}				kV	6	6	6	6	6	6	6	
Rated operational current I_e												
AC-21A	Switching of resistive loads, including moderate overloads			A	40	50	63	100	150	200	315	
AC-22A	Switching of combined resistive or low inductive loads, including moderate overloads			220 V – 500 V	A	40	50	63	100	150	150	315
				660 V – 690 V	A	40	50	63	100	125	125	125
AC-15	Switching of control devices, contactors, valves etc.			220 V – 240 V	A	14	16	16	-	-	-	-
				380 V – 440 V	A	6	7	7	-	-	-	-
Rated utilization category												
AC-3	Direct-on-line starting	3-phase, 3-pole	220 V – 240 V	kW	7,5	11	11	15	22	22	37	
			380 V – 440 V		15	18,5	18,5	30	37	37	55	
			500 V		15	18,5	18,5	30	37	37	55	
			660 V – 690 V		15	18,5	22	30	30	30	37	
AC-4	Direct-on-line starting, reversing, plugging and inching	3-phase, 3-pole	220 V – 240 V	kW	3,7	4	5,5	6	10	10	15	
			380 V – 440 V		6	7	7,5	11	15	15	25	
			500 V		6	7	7,5	11	15	15	25	
			660 V – 690 V		6	7,5	9	11	15	15	22	
AC-23A	Frequent switching of motors or other high inductive loads	3-phase, 3-pole	220 V – 240 V	kW	1,1	1,2	1,2	1,5	2,2	2,2	4	
			220 V – 240 V		2,2	2,4	2,4	3	4	4	7,5	
			380 V – 440 V		3,7	4	4	5,5	7,5	7,5	11	
			500 V		-	-	-	-	-	-	-	
AC-23A	Frequent switching of motors or other high inductive loads	3-phase, 3-pole	220 V – 240 V	kW	7,5	11	15	30	37	37	75	
			380 V – 440 V		18,5	22	30	45	75	75	132	
			500 V		18,5	22	30	55	90	90	132	
			660 V – 690 V		18,5	22	30	45	55	55	37	
AC-23A	Frequent switching of motors or other high inductive loads	1-phase, 2-pole	110 V – 120 V	kW	2,2	2,5	4	5,5	11	11	18,5	
			220 V – 240 V		4	5,5	10	15	22	22	37	
			380 V – 440 V		7,5	11	18,5	22	37	37	55	
			500 V		-	-	-	-	-	-	-	
AC-23A	Frequent switching of motors or other high inductive loads	1-phase, 2-pole	110 V – 120 V	kW	2,2	2,5	4	5,5	11	11	18,5	
			220 V – 240 V		4	5,5	10	15	22	22	37	
			380 V – 440 V		7,5	11	18,5	22	37	37	55	
			500 V		-	-	-	-	-	-	-	
AC-23A	Frequent switching of motors or other high inductive loads	1-phase, 2-pole	110 V – 120 V	kW	2,2	2,5	4	5,5	11	11	18,5	
			220 V – 240 V		4	5,5	10	15	22	22	37	
			380 V – 440 V		7,5	11	18,5	22	37	37	55	
			500 V		-	-	-	-	-	-	-	
AC-23A	Frequent switching of motors or other high inductive loads	1-phase, 2-pole	110 V – 120 V	kW	2,2	2,5	4	5,5	11	11	18,5	
			220 V – 240 V		4	5,5	10	15	22	22	37	
			380 V – 440 V		7,5	11	18,5	22	37	37	55	
			500 V		-	-	-	-	-	-	-	
AC-23A	Frequent switching of motors or other high inductive loads	1-phase, 2-pole	110 V – 120 V	kW	2,2	2,5	4	5,5	11	11	18,5	
			220 V – 240 V		4	5,5	10	15	22	22	37	
			380 V – 440 V		7,5	11	18,5	22	37	37	55	
			500 V		-	-	-	-	-	-	-	
AC-23A	Frequent switching of motors or other high inductive loads	1-phase, 2-pole	110 V – 120 V	kW	2,2	2,5	4	5,5	11	11	18,5	
			220 V – 240 V		4	5,5	10	15	22	22	37	
			380 V – 440 V		7,5	11	18,5	22	37	37	55	
			500 V		-	-	-	-	-	-	-	
AC-23A	Frequent switching of motors or other high inductive loads	1-phase, 2-pole	110 V – 120 V	kW	2,2	2,5	4	5,5	11	11	18,5	
			220 V – 240 V		4	5,5	10	15	22	22	37	
			380 V – 440 V		7,5	11	18,5	22	37	37	55	
			500 V		-	-	-	-	-	-	-	
AC-23A	Frequent switching of motors or other high inductive loads	1-phase, 2-pole	110 V – 120 V	kW	2,2	2,5	4	5,5	11	11	18,5	
			220 V – 240 V		4	5,5	10	15	22	22	37	
			380 V – 440 V		7,5	11	18,5	22	37	37	55	
			500 V		-	-	-	-	-	-	-	
AC-23A	Frequent switching of motors or other high inductive loads	1-phase, 2-pole	110 V – 120 V	kW	2,2	2,5	4	5,5	11	11	18,5	
			220 V – 240 V		4	5,5	10	15	22	22	37	
			380 V – 440 V		7,5	11	18,5	22	37	37	55	
			500 V		-	-	-	-	-	-	-	
AC-23A	Frequent switching of motors or other high inductive loads	1-phase, 2-pole	110 V – 120 V	kW	2,2	2,5	4	5,5	11	11	18,5	
			220 V – 240 V		4	5,5	10	15	22	22	37	
			380 V – 440 V		7,5	11	18,5	22	37	37	55	
			500 V		-	-	-	-	-	-	-	
AC-23A	Frequent switching of motors or other high inductive loads	1-phase, 2-pole	110 V – 120 V	kW	2,2	2,5	4	5,5	11	11	18,5	
			220 V – 240 V		4	5,5	10	15	22	22	37	
			380 V – 440 V		7,5	11	18,5	22	37	37	55	
			500 V		-	-	-	-	-	-	-	
AC-23A	Frequent switching of motors or other high inductive loads	1-phase, 2-pole	110 V – 120 V	kW	2,2	2,5	4	5,5	11	11	18,5	
			220 V – 240 V		4	5,5	10	15	22	22	37	
			380 V – 440 V		7,5	11	18,5	22	37	37	55	
			500 V		-	-	-	-	-	-	-	
AC-23A	Frequent switching of motors or other high inductive loads	1-phase, 2-pole	110 V – 120 V	kW	2,2	2,5	4	5,5	11	11	18,5	
			220 V – 240 V		4	5,5	10	15	22	22	37	
			380 V – 440 V		7,5	11	18,5	22	37	37	55	
			500 V		-	-	-	-	-	-	-	
AC-23A	Frequent switching of motors or other high inductive loads	1-phase, 2-pole	110 V – 120 V	kW	2,2	2,5	4	5,5	11	11	18,5	
			220 V – 240 V		4	5,5	10	15	22	22	37	
			380 V – 440 V		7,5	11	18,5	22	37	37	55	
			500 V		-	-	-	-	-	-	-	
AC-23A	Frequent switching of motors or other high inductive loads	1-phase, 2-pole	110 V – 120 V	kW	2,2	2,5	4	5,5	11	11	18,5	
			220 V – 240 V		4	5,5	10	15	22	22	37	
			380 V – 440 V		7,5	11	18,5	22	37	37	55	
			500 V		-	-	-	-	-	-	-	
AC-23A	Frequent switching of motors or other high inductive loads	1-phase, 2-pole	110 V – 120 V	kW	2,2	2,5	4	5,5	11	11	18,5	
			220 V – 240 V		4	5,5	10	15	22	22	37	
			380 V – 440 V		7,5	11	18,5	22	37	37	55	
			500 V		-	-	-	-	-	-	-	
AC-23A	Frequent switching of motors or other high inductive loads	1-phase, 2-pole	110 V – 120 V	kW	2,2	2,5	4	5,5	11	11	18,5	
			220 V – 240 V		4	5,5	10	15	22	22	37	
			380 V – 440 V		7,5	11	18,5	22	37	37	55	
			500 V		-	-	-	-	-	-	-	
AC-23A	Frequent switching of motors or other high inductive loads	1-phase, 2-pole	110 V – 120 V	kW	2,2	2,5	4	5,5	11	11	18,5	
			220 V – 240 V		4	5,5	10	15	22	22	37	
			380 V – 440 V		7,5	11	18,5	22	37	37	55	
			500 V		-	-	-	-	-	-	-	
AC-23A	Frequent switching of motors or other high inductive loads	1-phase, 2-pole	110 V – 120 V	kW	2,2	2,5	4	5,5	11	11	18,5	
			220 V – 240 V		4	5,5	10	15	22	22	37	
			380 V – 440 V		7,5	11	18,5	22	37	37	55	
			500 V		-	-	-	-	-	-	-	
AC-23A	Frequent switching of motors or other high inductive loads	1-phase, 2-pole	110 V – 120 V	kW	2,2	2,5	4	5,5	11	11	18,5	
			220 V – 240 V		4	5,5	10	15	22	22	37	
			380 V – 440 V		7,5	11	18,5	22	37	37	55	
			500 V		-	-	-	-	-	-	-	
AC-23A	Frequent switching of motors or other high inductive loads	1-phase, 2-pole	110 V – 120 V	kW	2,2	2,5	4	5,5	11	11	18,5	
			220 V – 240 V		4	5,5	10	15	22	22	37	
			380 V – 440 V		7,5	11	18,5	22	37	37	55	
			500 V		-	-	-	-	-	-	-	
AC-23A	Frequent switching of motors or other high inductive loads	1-phase, 2-pole	110 V – 120 V	kW	2,2	2,5	4	5,5	11	11	18,5	
			220 V – 240 V		4	5,5	10	15	22	22	37	
			380 V – 440 V		7,5	11	18,5	22	37	37	55	
			500 V		-	-	-	-	-	-	-	
AC-23A	Frequent switching of motors or other high inductive loads	1-phase, 2-pole	110 V – 120 V	kW	2,2	2,5	4	5,5	11	11	18,5	
			220 V – 240 V		4	5,5	10	15	22	22	37	
			380 V – 440 V		7,5	11	18,5	22	37	37	55	
			500 V		-	-	-	-	-	-	-	
AC-23A	Frequent switching of motors or other high inductive loads	1-phase, 2-pole	110 V – 120 V	kW	2,2	2,5	4	5,5	11	11	18,5	
			220 V – 240 V		4	5,5	10	15	22	22	37	
			380 V – 440 V		7,5	11	18,5	22	37	37	55	
			500 V		-	-	-	-	-	-	-	
AC-23A	Frequent switching of motors or other high inductive loads	1-phase, 2-pole	110 V – 120 V	kW	2,2	2,5	4	5,5	11	11	18,5	
			220 V – 240 V		4	5,5	10	15	22	22	37	
			380 V – 440 V		7,5	11	18,5	22	37	37	55	
			500 V		-	-	-	-	-	-	-	
AC-23A	Frequent switching of motors or other high inductive loads	1-phase, 2-pole	110 V – 120 V	kW	2,2	2,5	4	5,5	11	11	18,5	
			220 V – 240 V		4	5,5	10	15	22	22	37	
			380 V – 440 V		7,5	11	18,5	22	37	37	55	
			500 V		-	-	-	-	-	-	-	
AC-23A	Frequent switching of motors or other high inductive loads	1-phase, 2-pole	110 V – 120 V	kW	2,2	2,5	4	5,5	11	11	18,5	
			220 V – 240 V		4	5,5	10	15	22	22	37	
			380 V – 440 V		7,5	11	18,5	22	37	37	55	
			500 V		-	-	-	-	-			

CONTROL SWITCHES AND LOAD SWITCHES

Switch type according USA / Canada											
Electrical data				CA4 CG4	DH10/B	CH6 CH10/B	CG8/B CA10/B CA11/B	CH16/B	CA20/B	CA25/B	
Thermal current I_U/I_{th}				A	10	15	20	16 ^B /20	25	30	30
Insulation voltage U_i¹				V	300	600	600	300 ^C /600	600	600	300
Rated operational current I_e¹											
Pilot duty		Heavy		VAC	A300	A600	A600	A300 ^C /A600	A600	A600	A300
Ampere rating		Resistive or low inductive loads		A	10	15	20	10 ^B /20	25	30	30
Max. permissible wire gage (use Copper wire only)					2 x	2 x	2 x	2 x	2 x	2 x	2 x
Single-core or stranded wire				AWG	14	12	10	12	10	10	8
AWG wiring without sleeve				AWG	16	14	12	14	12	12	10
Rated utilization category											
Standard motor load DOL-rating (similar to AC-3)	3-phase 3-pole	110 V – 120 V	HP	0,75	0,75	1,5	1,5	2	3	5	
		220 V – 240 V		1	1,5	3	3 (1 ^A)	5	7,5	10	
		440 V – 480 V		-	3	5	5 ^D	10	10	-	
		550 V – 600 V		-	3	5	5 ^D	10	10	-	
1-phase 2-pole	110 V – 120 V	HP	0,33	0,25	0,5	0,5	1	1,5	2		
	220 V – 240 V		0,75	0,5	1	1	2	3	5		
	277 V		0,75	0,5	2	2 (1 ^A)	3	3	5		
	440 V – 480 V		-	1	2	2 ^D	5	5	-		
550 V – 600 V	-	1	2	2 ^D	5	5	-				
Heavy motor load Reversing-Rating (similar to AC-4)	3-phase 3-pole	110 V – 120 V	HP	-	-	0,5	0,5	1	1	2	
		220 V – 240 V		-	-	1	1	2	2	3	
		440 V – 600 V		-	-	3	3 ^D	5	5	-	
1-phase 2-pole	110 V – 120 V	HP	-	-	0,17	0,17	0,33	0,33	1,5		
	220 V – 240 V		-	-	0,5	0,5	0,75	0,75	3		
	277 V		-	-	0,6	0,6 (0,5 ^A)	1	1	3		
	440 V – 600 V		-	-	1,5	-	2	-	-		

¹ International standards and approvals, refer to page 204

^A Only applies to CG8 | ^B Only applies to CG8 | ^C Only applies to CG8 und CA10 | ^D Only applies to CA11/B



Switch type according USA / Canada											
Electrical data				CA40 CA40C	CA50 CA50C	CA63 CA63C	C80	C125	C200-4	C315	
Thermal current I_U/I_{th}				A	45	55	65	100	150	-	240
Insulation voltage U_i¹				V	600	600	600	600	600	-	600
Rated operational current I_e¹											
Pilot duty		Heavy		VAC	A600	A600	A600	-	-	-	A600
Ampere rating		Resistive or low inductive loads		A	45	55	60	100	150	-	240
Max. permissible wire gage (use Copper wire only)											
Single-core or stranded wire				AWG	6	6	6	2	2/0		MCM350
AWG wiring without sleeve				AWG	6	6	6	3	1/0		MCM300
Rated utilization category				UL / Canada							
Standard motor load DOL-rating (similar to AC-3)		3-phase 3-pole		110 V–120 V	7,5	7,5	7,5	10	15	-	30
				220 V–240 V	15	15	15	20	25	-	75
				440 V–480 V	25	25	30	30	40	-	75
				550 V–600 V	25	30	30	40	50	-	60
		1-phase 2-pole		110 V–120 V	3	3	3	5	7,5	-	15
				220 V–240 V	7,5	7,5	7,5	10	15	-	40
				277 V	7,5	7,5	10	10	15	-	40
				440 V–480 V	15	15	15	20	25	-	50
				550 V–600 V	15	20	20	25	30	-	50
Heavy motor load Reversing-Rating (similar to AC-4)		3-phase 3-pole		110 V–120 V	-	-	-	7,5	10	-	15
				220 V–240 V	-	-	-	15	20	-	30
				440 V–600 V	-	-	-	25	30	-	40
1-phase 2-pole				110 V–120 V	-	-	-	3	5	-	7,5
				220 V–240 V	-	-	-	7,5	10	-	15
				277 V	-	-	-	7,5	10	-	15

¹ International standards and approvals, refer to page 204

Auxiliary contact M510B			Size S1 (CA40–CA63)	Size S2 + S3 (C80–C315)
Rated values				
Rated impulse withstand voltage U _{imp}		V	600	600
Thermal current		A	10	10
Pilot duty Heavy			A600	A600
Ampere rating		Resistive or low inductive loads	A	10
Max. permissible wire gage (use Copper wire only)				
Single-core or stranded wire		AWG	14	12
Flexible wire without sleeve		AWG	16	14



CONTROL SWITCHES AND LOAD SWITCHES

Switch type according IEC 60947-3, EN 60947-3, VDE 0660 part 107

			CGD4-1 CAD4-1	CG4-1	CA4-1	CH11	CAD11	DH11/B	
Thermal current I_U/I_{th}			A	5	10	10	6	6	
Rated impulse withstand voltage U_{imp}			kV	on request	4	4	6	6	
Insulation voltage U_i ¹			V	440	440	440	600	600	
Min. voltage			V	1 ⁷	on request	1 ⁷	1	1 ⁷	
Rated operational current I_e									
AC-21A	Switching of resistive loads, including moderate overloads	1 V/6 V	A	5/2	-	-	6/3	6/3	6/3
		12 V/24 V	A	1,2/0,7	-	-	2/1	2/1	2/1
		48 V/60 V	A	0,45/-	-	-	0,8/0,7	0,8/-	0,8/-
		110 V/240 V	A	0,25/0,15	-	-	0,4/0,2	0,4/0,2	0,4/0,2
		300 V/440 V	A	0,13/0,1	-	-	0,13/0,1	0,13/0,1	-/0,1
		500 V/600 V	A	-	-	-	0,08/0,05	0,08/0,05	0,09/0,05
Power loss per pol at I_U			W	0,4	0,7	0,9	0,4	0,5	
Short circuit protection									
Max. fuse size			gG-Characteristic	A	5 ⁸	10	10	6 ⁸	6 ⁸
Rated short-time withstand current (1 sec. current)			A	30	90	60	35	35	40
DC switching capacity ⁵									
DC-21B	Ohmic circuit	1 V/6 V	A	3/1,2	-/-	-/-	4/2,5	4/2,5	4/2,5
		12 V/24 V	A	0,7/0,4	-/10	-/10	1,5/0,8	1,5/0,8	1,5/0,8
		48 V/60 V	A	0,25/0,2	6/2,5	6/2,5	0,3/0,27	0,3/0,27	0,3/0,27
		110 V/220 V	A	0,13/-	0,7/0,3	0,7/0,3	0,2/-	0,2/0,1	0,2/0,1
		240 V/300 V	A	0,8/0,7	-/-	-/-	0,1/0,07	0,08/-	0,08/-
		440 V/500 V	A	0,05/-	0,2/-	0,2/-	0,05/0,03	-/0,03	0,05/0,04
Max. permissible wire gage (use Copper wire only)									
Single-core or stranded wire			mm ²	2 x	2 x	2 x	2 x	2 x	
Flexible wire			mm ²	1,5	1,5	1,5	4	2,5	2,5
Flexible wire sleeving in accordance with DIN 46228			mm ²	1	1	1	2,5	2,5	1,5
Max. ambient temperature ^{4, 6}									
open at 100 % I_U/I_{th}								55 °C during 24 hours with peaks up to 60 °C	
enclosed at 100 % I_{th}								35 °C during 24 hours with peaks up to 40 °C	

Switch type according USA / Canada

			CGD4-1 CAD4-1	CG4-1	CA4-1	CH11	CAD11	DH11/B	
Thermal current I_U/I_{th}			A	5	10	10	6	6	
Insulation voltage U_i ⁹			V	300	300	300	300	600	
Rated operational current I_e									
AC-21A	Switching of resistive loads, including moderate overloads	1 V/6 V	A	5/2	-	-	6/3	6/3	-
		12 V/24 V	A	1,2/0,7	-	-	2/1	2/1	-
		48 V/110 V	A	0,45/0,25	-	-	0,8/0,4	0,8/0,4	-
		240 V/300 V	A	0,15/0,13	-	-	0,2/0,13	0,2/-	-
DC switching capacity ⁵									
DC-21B	Ohmic circuit	1 V/6 V	A	3/1,2	-/-	-/-	4/2,5	4/2,5	4/2,5
		12 V/24 V	A	0,7/0,4	-/10	-/10	1,5/0,8	1,5/0,8	1,5/0,8
		48 V/60 V	A	0,25/0,2	6/2,5	6/2,5	0,3/0,27	0,3/0,27	0,3/0,27
		110 V/220 V	A	0,13/-	0,7/0,3	0,7/0,3	0,2/-	0,2/0,1	0,2/0,1
		240 V/300 V	A	0,8/0,7	-/-	-/-	0,1/0,07	0,08/-	0,08/-
Max. permissible wire gage (use Copper wire only)									
Single-core or stranded wire			AWG	14	14	14	10	12	12
AWG wiring without sleeve			AWG	16	16	16	12	14	14

¹ Valid for lines with common neutral termination, overvoltage category III, pollution degree 3 Values for other supply systems on request | ² For electromagnetic optional extras see additional data in the chapter **Optional Extras**. | ³ Values for Switches with spring return on request | ⁴ Storage Temperature: -40 °C at 85 °C (at Temperature under -5 °C no impact load permitted). | ⁵ Lower values on request. | ⁶ G-Fuse, nimble | ⁷ International standards and approvals, refer to page 204.



Detailed selection switch type



Selection DC switches									IEC 60947-3, EN 60947-3, VDE 0660 part 107 (Switch function on request)																	
									CA4	CA10	CA10S	CA20	CA20S	CA25	CA25S	CA40	CA40S	CA63	CA63S							
Series contacts	1	2	3	4	5	6	8																			
									Admissible voltage in Volt									Rated operational current I _e								
Utilization category DC-21A, DC-21B	24	48	72	96	120	144	192	A	16	16	21	24	26	32	40	63										
	48	96	144	192	240	288	384	A	14	15	18	24	25	32	40	63										
	60	120	180	240	300	360	480	A	13	15	17	21	24	28	40	50										
	Switching of resistive loads Response time L/R≤1ms	110	220	330	440	550	660	-	A	6	7	6	7	7	9,3											
	220	440	660	-	-	-	-	A	0,9	1	1	1	1	1												
Utilization category DC-22A, DC-22B	24	48	72	96	120	144	192	A	14	15	18	24	25	32	40	63										
	48	96	144	192	240	288	384	A	13	15	17	24	25	32	40	63										
	60	120	180	240	300	360	480	A	12	15	16	19	24	25	20	25										
	Switching of mixed resistive and inductive loads (e.e. shunt motors)	110	220	330	440	550	660	-	A	1,9	2	2	2	2,25	3											
	220	440	660	-	-	-	-	A	0,3	0,35	0,3	0,35	0,35	0,35												
Utilization category DC-23A, DC-23B	24	48	72	96	120	144	192	A	13	15	16	23	23	32	40	63										
	48	96	144	192	240	288	384	A	12	15	15	23	21	32	40	63										
	60	120	180	240	300	360	480	A	10	13	14	16	20	25												
	Switching of highly inductive loads (i.e. series motors)	110	220	330	440	550	660	-	A	1,5	1,75	1,7	1,75	2	2,5											
	220	440	660	-	-	-	-	A	0,2	0,3	0,2	0,3	0,2	0,3												
Utilization category DC-13	24	48						A	3		4		5													
	48	96						A	1,7		2,4		3													
	60	120						A	1,4		1,8		2,5													
	Control of DC electromagnetics Response time L/R≤100ms	110	220						A	0,7		1		1,5												
	220	440						A	0,15		0,35		0,5													

Switching angles 60° or 90° (size S0) only possible for switch CA...S.

At higher voltages up to and including 1000 V/20 A the switch type G20S is available. Information at page 204 ff.

Control switch	Following technical data apply to the mentioned switch types intended for use as control switch for isolation with direct opening action according to Annex K of IEC 60947-5-1:2016, EN 60947-5-1:2017 and VDW 0660 Part 200:03:2018 referring to Low-Voltage Switchgear and Controlgear, Control Circuit Devices and Switching Elements.											
	CA4 CA4N CA4-1 CA4N-1 CG4 CG4-1	CG6 CG7	CH6 CHR6	CA10 CA11	CA10-1 CA11-1	CG8 CG9	CH10 CHR10	CH10-1 CHR10-1	CA20	CH16 CHR16		
Rated Operational Voltage U _e max. ¹	V	400	400	400	400	400	400	400	400	400	400	400
Rated Impulse Withstand Voltage U _{imp} ¹	kV	4	4	4	4	4	4	4	4	4	4	4
Rated Thermal Current I _{th} = I _u	A	10	20	20	20	20	20	20	16	25	25	25
Rated Operational Current I _e												
AC-13	24-400 V	A	6	12	10	12	6	12	10	5	16	15
AC-14	24-60 V	A	5	12	10	12	5	12	10	4	16	15
	110 V	A	4	10	8	10	5	10	8	3	12	10
	230 V	A	4	10	8	10	4	10	8	3	12	10
	400 V	A	2,5	7	7	7	2,5	7	7	2	8	8
AC-15	24-60 V	A	3	8	6	8	3	8	6	2	10	8
	110 V	A	2,5	6	5	6	3	6	5	1,5	8	8
	230 V	A	2,5	5	5	5	2,5	5	5	1,5	8	8
	400 V	A	1,5	4	4	4	1,5	4	4	1	5	5
Rated Conditional Short-Circuit Current	kA	1	1	1	1	1	1	1	1	1	1	1
Short Circuit Protection: gG-Fuse	A	10	20	20	20	20	20	20	20	16	16	25
Direct Opening Action guaranteed resp. Direct Opening Action Symbol		valid for	all manually opened switch contacts									
Presupposition:												
1) Maximum Number of Stages		6	4	4	6	8	6	8	6	8	6	8
2) Maximum Number of Contacts opened at the same time for switches with latching positions ²												
Switching Angle	30°	-	-	-	10	6	10	6	10	6	10	6
	45°	6	8	8	12	10	12	10	12	10	12	10
	60°	10	8	8	12	12	12	12	12	12	12	12
	90°	12	8	8	12	16	12	16	12	16	12	16

¹ Valid for single-phase circuits, overvoltage category II, pollution degree 3. Values for other supply systems or overvoltage categories on request. | ² The number of contacts indicated do not consider any cam-cut extension.



Detailed selection switch type

CONTROL SWITCHES AND LOAD SWITCHES

Switch functions

Ordering example	(Chapter switch types) C110	A200	F (Chapter mounting)
	(Chapter switch types) C110	WAA341 F070 ²	F (Chapter mounting)
Not every switch function is standardized for all types	Angle °	Poles	Stages
			Code
			Switch functions + Connection diagram page

ON/OFF switches



0 - 1	60	1	1	A200	109
		2	1	A201	109
		3	2	A202	109
		4	2	A203	109
		5	3	WAA341 F070	109
		6	3	A342	109
		7	4	A343	109
		8	4	A344	109
		9	5	WAA345 F070	109
		10	5	A346	109
		11	6	WAA347 F070	109
		12	6	A348	109

0 - 1 pre-close N		4	2	WAA653 F070	109
		8	4	WAA654 F070	109



0 - 1	90	1	1	A290	109
		2	1	A291	109
		3	2	A292	109
		4	2	A324	109
		5	3	WAA325 F056	109
		6	3	A326	109
0 - 1 pre-close N		4	2	A293	109

0 - 1 - 0 - 1 rotation 360°	90	3	2	WAA208 F062	109
-----------------------------	----	---	---	----------------	-----



0 - 1 symmetric	90	1	1	WAA590 F700	109
		2	1	WAA591 F700	109
		3	2	WAA592 F700	109
		4	2	WAA593 F700	109



0 - 1	30	1	1	WAA100 F169	109
		2	1	WAA101 F169	109
		3	2	WAA102 F169	109
		4	2	WAA103 F169	109
0 - 1 with spring return ¹		1	1	A204 F169	109
		2	1	A205 F169	109
		3	2	WAA206 F169	109
		4	2	WAA207 F169	109

Double-throw switches without "OFF"





1 - 2	60	1	1	A220	109
		2	2	A221	109
		3	3	A222	109
		4	4	A223	109
		5	5	A369	109
		6	6	A370	109
		7	7	A371	109
		8	8	A372	109
		9	9	WAA373 F072	109
		10	10	WAA374 F072	109
		11	11	WAA375 F072	110
		12	12	WAA376 F072	109

¹ Not possible for Switch type C315. | ² For switch type C315.WAA... the terminal lugs S3D.D625 are additionally specify. Number corresponds to termination points.







Switch functions						
Ordering example		(Chapter switch types) CH10	A200	E (Chapter mounting)		
Ordering example		(Chapter switch types) CH10	WAA341 F070²	E (Chapter mounting)		
Not every switch function is standardized for all types		Angle °	Poles	Stages	Code	Switch functions + Connection diagram page

Double-throw switches without 'OFF'

	1 – 2 Pre-close N		4	4	WAA673 F072	110
			8	8	WAA972 F072	110
	1 – 2	90	1	1	A530	110
			2	2	WAA531 F254	110
			3	3	WAA532 F254	110
		4	4	WAA533 F254	110	
	1 – 2 symmetric	90	1	1	WAA520 F743	110
			2	2	WAA521 F743	110
			3	3	WAA522 F743	110
			4	4	WAA523 F743	110
			6	6	WAA570 F743	110
	1 – 2 ¹	30	1	1	WAA120 F026	110
			2	2	WAA121 F026	110
			3	3	WAA122 F026	110
			4	4	WAA123 F026	110
	1 – 2 with Spring Return ¹		1	1	A295	110
		2	2	A296	110	
		3	3	WAA297 F026	110	

Double-throw switches without 'OFF' with electrical isolated contacts

	1 – 2 symmetric 60°	60	1	1	A720	110
			2	2	A721	110
			3	3	A722	110
			4	4	A723	110
	1 – 2 Pre-close N		4	4	WAA973 F072	110
	1 – 2	90	1	1	A585	110
			2	2	A586	110
			3	3	WAA587 F254	110
	1 – 2 symmetric 90°	90	1	1	WAA588 F254	110
			2	2	A575	110
			3	3	A576	110
			4	4	WAA577 F743	110
	1 – 2 with Spring Return ¹	30	1	1	A795	110

Double-throw switches with 'OFF' (continued on next page)

	1 – 0 – 2	60	1	1	A210	110
			2	2	A211	110
			3	3	A212	110
			4	4	A213	110
			5	5	A361	111
			6	6	A362	111
			7	7	WAA363 F071	111
			8	8	WAA364 F071	111
	1 – 0 – 2 Pre-close N		4	4	WAA913 F071	111
		8	8	WAA664 F071	111	

¹ Not possible for Switch types CA40 up to CA63, C80, C125, C200-4 and C315. | ² For switch type C315.WAA... the terminal lugs S3D.D625 are additionally specify. Number corresponds to termination points.

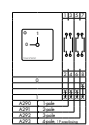

CONTROL SWITCHES AND LOAD SWITCHES

Switch functions

Ordering example	(Chapter switch types) CH10		A200	F (Chapter mounting)	
	(Chapter switch types) CH10		WAA341 F070 ²	F (Chapter mounting)	
Not every switch function is standardized for all types	Angle °	Poles	Stages	Code	Switch functions + Connection diagram page

Double-throw switches with 'OFF' (continued)

	HAND - 0 - AUTO	60	1	1	A210 F085	111
			2	2	A211 F085	111
			3	3	A212 F085	111
	1 - 0 - 2	90	1	1	A218	111
			2	2	A219	111
			3	3	WAA299 F057	111
	1 - 0 - 2 Pre-close N		4	4	WAA294 F057	111
	1 - 0 - 2	45	1	1	A510	111
			2	2	WAA511 F216	111
			3	3	WAA512 F216	111
			4	4	WAA513 F216	111
	1 > 0 < 2 With spring return to center	30	1	1	A214	111
			2	2	A215	111
			3	3	A216	111
	1 > 0 < 2 With spring return to center ¹	45	1	1	WAA514 F216	111
			2	2	WAA515 F216	111
	1 > 0 - 2 With spring return	30/60	1	1	A320 F341	111
			2	2	A321 F341	111
			3	3	A322 F341	111

Double-throw switches with 'OFF' with electrical isolated contacts

	1 - 0 - 2	60	1	1	A710	111
			2	2	A711	111
			3	3	A712	111
			4	4	A713	111
	1 - 0 - 2 Pre-close N		4	4	WAA963 F071	112
	1 > 0 < 2 With spring return to center	30	1	1	A714	112
			2	2	A715	112
	1 - 0 - 2	45	1	1	A565	112
			2	2	WAA566 F216	112
			3	3	WAA567 F216	112
			4	4	WAA568 F216	112

Group switches

	0 - 1 - 2 2 groups	60	1	1	A310	112
	Switching sequence: 0, A, A+B		2	2	A312	112
			3	3	WAA314 F075	112
	0 - 1 - 2 - 3 3 groups	30	1	2	A311	112
	Switching sequence: 0, A, A+B, A+B+C		2	3	WAA313 F001	112
			3	5	WAA315 F001	112
	0 - 1 - 2 - 3 2 groups series switching	30	1	1	WAA330 F001	112
	Switching sequence: 0, A, B, A+B		2	2	WAA331 F001	112
			3	3	WAA332 F001	112
	0-1-2-3 2 Groups series-parallel switching		2	2	WAA339 F001	112
	Switching sequence: 0, A+B Serie, A, A+B parallel					

¹ On request. Only for switches with integrated return latching mechanism. | ² For switch type C315.WAA... the terminal lugs S3D.D625 are additionally specify. Number corresponds to termination points.



Switch functions						
Ordering example	(Chapter switch types) CH10		A200	E (Chapter mounting)		
	(Chapter switch types) CH10		WAA341 F070 ²	E (Chapter mounting)		
Not every switch function is standardized for all types		Angle °	Poles	Stages	Code	Switch functions + Connection diagram page
Code switches with binary coding						
	0 – 7 rotation 360°	45		2	A540	112
	0 – 7 complement rotation 360°			2	WAA541 F322	113
	0 – 7 + complete rotation 360°			3	WAA542 F322	113
	0 – 9	30		2	A550	113
	0 – 9 complement			2	WAA551 F007	113
	0 – 9 + complement			4	WAA552 F007	113
	0 – 11 rotation 360°	30		2	A543	113
	0 – 11 + complement rotation 360°			4	WAA545 F009	113
Multi-step switches without "OFF"						
	3 stages	60	1	2	A230	113
				3	A250	113
				4	A270	113
				5	A476	113
				6	WAA484 F076	113
				9	WAA489 F076	113
	4 stages	60	1	2	A231	113
				4	A251	113
				6	A271	113
				8	A477	114
				10	WAA485 F077	114
				12	WAA490 F077	114
	5 stages	60	1	3	A232	114
				5	A252	114
				8	WAA272 F078	114
				10	WAA478 F078	114
	6 stages	60	1	3	A233	114
				6	WAA253 F079	114
				9	WAA273 F079	114
	7 stages	45	1	4	WAA234 F110	114
				7	WAA254 F110	114
				11	WAA274 F110	114
	8 stages	45	1	4	WAA235 F111	114
				8	WAA255 F111	114
				12	WAA275 F111	114
	9 stages	30	1	5	WAA236 F010	115
	10 stages	30	1	5	WAA237 F011	115
	11 stages	30	1	6	WAA238 F012	115
	12 stages	30	1	6	WAA239 F013	115
	12 stages with rotation 360°		1	6	WAA639 F013	115

² For switch type C315.WAA... the terminal lugs S3D.D625 are additionally specify. Number corresponds to termination points.

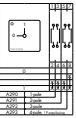

CONTROL SWITCHES AND LOAD SWITCHES

Switch functions

Ordering example	(Chapter switch types) C110	A200	E (Chapter mounting)
	(Chapter switch types) C110	WAA341 F070 ²	E (Chapter mounting)
Not every switch function is standardized for all types	Angle °	Poles	Stages
			Code
			Switch functions + Connection diagram page

Multi-step switches without "OFF" with electrical isolated contacts



3 stages	60	1	2	A730	115
		2	3	A750	115



4 stages	60	1	2	A731	115
		2	4	A751	115

Multi-step switches with "OFF"



2 stages	60	1	1	A240	115
		2	2	A260	115
		3	3	A280	115
		4	4	WAA480 F075	115
		5	5	WAA486 F075	115
3 stages	45	1	2	A241	115
		2	3	A261	115
		3	5	A281	115
		4	6	WAA481 F109	116
		5	8	WAA487 F109	116
		6	6	WAA491 F075	115



4 stages	30	1	2	A242	116
		2	4	WAA262 F002	116
		3	6	WAA282 F002	116
		4	8	WAA482 F002	116



5 stages	30	1	3	A243	116
		2	5	WAA263 F003	116
		3	8	WAA283 F003	116



6 stages	30	1	3	A244	116
		2	6	WAA264 F004	116
		3	9	WAA284 F004	116



7 stages	30	1	4	WAA245 F005	116
		2	7	WAA265 F005	116



8 stages	30	1	4	WAA246 F006	116
----------	----	---	---	----------------	-----



9 stages	30	1	5	WAA247 F007	117
----------	----	---	---	----------------	-----



10 stages	30	1	5	WAA248 F008	117
-----------	----	---	---	----------------	-----



11 stages	30	1	6	WAA249 F009	117
11 stages with rotation 360°		1	6	WAA649 F009	117

² For switch type C315.WAA... the terminal lugs S3D.D625 are additionally specify. Number corresponds to termination points.



Switch functions						
Ordering example		(Chapter switch types) C310	A200	E (Chapter mounting)		
Not every switch function is standardized for all types		(Chapter switch types) CH10	WAA341 F070²	E (Chapter mounting)		
		Angle °	Poles	Stages	Code	Switch functions + Connection diagram page
Voltmeter switch without "OFF"						
	L1-L2 – L2-L3 – L3-L1 3 phase	45		2	A023 F793	117
	L3-L1 – L2-L3 – L1-L2 – L1-N – L2-N – L3-N 3 phase to phase and 3 phase to neutral	45		3	A025 F795	117
Voltmeter switch with "OFF"						
	0 – L1-L2 – L2-L3 – L3-L1 3 phase, 3 wire	45		2	A004 F778	117
	0 – L1-N – L2-N – L3-N 3 phase to neutral	45		2	WAA005 F781	117
	L3-L1 – L2-L3 – L1-L2 – 0 – L1-N – L2-N – L3-N 3 phase to phase and 3 phase to neutral	45		3	A007 F785	117
	L3-L1 – L2-L3 – L1-L2 – 0 – L1-L2 – L2-L3 – L3-L1 2 separate 3 phase with center "OFF"	45		4	WAA008 F788	117
	L3-L1 – L2-L3 – L1-L2 – 0 – L1-N 3 phase to phase, 1 phase	45		3	WAA010 F791	117
Ammeter switches						
	0 – 1, 1-pole, 1 current transformer	90	1	1	WAA046 F058	118
	1 – 2 – 3, 1-pole, 3 current transformers without "OFF"	90	1	3	WAA017 ¹ F719	118
	0 – 1 – 2 – 3, 1-pole, 3 current transformers with "OFF", rotation 360°	90	1	3	A048	118
	1 – 2 – 3 – 4, 1-pole, 4 current transformers	90	1	4	WAA036 F060	118
	1 – 0 – 2, 2-pole, 2 current transformers	90	2	3	WAA037 F057	118
	1 – 2 – 3, 2-pole, 3 current transformers	90	2	5	WAA019 F719	118
	0 – 1 – 2 – 3, 2-pole, 3 current transformers with "OFF"	90	2	5	A038	118
	1 – 2 – 3 – 4, 2-pole, 4 current transformers	90	2	6	WAA039 F060	118
Volt-Ammeter-switches						
	1 – 2 – 3 – 4 3 phase, 1 phase to neutral, 3 current, 2-pole	60	2	7	WAA028 F077	118



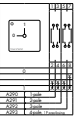



¹ Handle specified additionally | ² For switch type C315.WAA... the terminal lugs S3D.D625 are additionally specify. Number corresponds to termination points.







Switch functions

Ordering example	(Chapter switch types) C110	A200	E (Chapter mounting)		
	(Chapter switch types) CH10	WAA341 F070 ²	E (Chapter mounting)		
Not every switch function is standardized for all types	Angle °	Poles	Stages	Code	Switch functions + Connection diagram page



Control switches

	STOP > Stop switch (sensing device)	30		1	WAA174 F022	118
	< START Start switch (sensing device)	30		1	A175	118
	STOP > < START, Stop-start switch (sensing device))	30		1	A176	119
				2	WAA183 F024	119
	0 – 1 < START Stop-start switch with spring return from start to run (sensing device)	90/30		1	A178	119
	START > 1 – 0 – 2 < START Stop-start switch with spring return to run for 2 units (sensing device)	60/30		2	WAA177 F121	119
	START > 1 – 0 – 2 < START Stop-start switch with spring return to run with contactor interlock contactors for 2 units	60/30		2	WAA182 F121	119



Control switches with electrically isolated contacts

	STOP > < START Stop-start switch (sensing device)	30		1	A789	119
	0 – 1 < Start Stop-start switch with spring return from start to run (sensing device)	90/30		1	A791	119
	START > 1 – 0 – 2 < START Stop-start switch with spring return to run for 2 units (sensing device)	60/30		2	WAA790 F121	119
	1 – 0 – 2 Contactor control with spring return to "OFF"	30		2	WAA179 F025	119

Control and alarm switches















	Control and alarm switches with slip clutch and without indicator device			5	WAA190 F990	120
	Control and alarm switches without indicator device			2	WAA192 F990	120

Motor reversing switches

	1 – 0 – 2	60		2	A400	120
				3	A401	120
	1 – 0 – 2, with spring return to „OFF“	30		3	A228 ¹	120
	START > 1 – 0 – 2 < START For use with reversing contactors	60/30		3	WAA402 F121	120

¹ Only available up to switch type CA25B. | ² For switch type C315.WAA... the terminal lugs S3D.D625 are additionally specify. Number corresponds to termination points.



Switch functions						
Ordering example		(Chapter switch types) C110	A200	E (Chapter mounting)		
Not every switch function is standardized for all types		(Chapter switch types) C110	WAA341 F070 ²	E (Chapter mounting)		
		Angle °	Poles	Stages	Code	Switch functions + Connection diagram page
Motor control switches						
	0 - 1 - 2 2 speed, 2 winding, 0-A-BY or Δ	60		3	WAA451 F073	120
	0 - 1 - 2 - 3 3 speed, 2 winding, 0-AΔ-BY-AYY	45		6	WAA457 F109	120
Motor control switches						
	0 - 1 - 2 2 speed, single winding 0-AAY	60		4	A440	120
	1 - 2 2 speed, single winding without "OFF"	60		4	A466	120
	1 - 0 - 2 2 speed, single winding with center "OFF" AΔ-0-AY	60		4	A441	120
	2 - 1 - 0 - 1 - 2 2 speed, single winding reversing	45		6	A442	121
	0 - 1 - 2 For use with reversing contactors	60		5	WAA444 F073	121
	2 - 1 - Y - 0 - Y - 1 - 2 2 speed reversing for 2 way operation with slip clutch for "OFF" load use	45		10	WAA468 F294	121
Star-delta switches						
	0 - Y - Δ Standard	60		4	A410	121
	Δ - Y - 0 - Y - Δ Reversing	45		5	WAA413 F112	121
	0 - Y - Δ With auxiliary contact closed in "OFF" position	60		5	WAA416 F080	121
	For use with reversing contactors, 0 - Y - Δ	90		4	A419	121
Start and run switches						
	0 - 1 < START Split-phase start	90/30		2	A425	121
	1 - START - 0 - START - 2 Split-phase start reversing	30/60		3	WAA426 F120	121
	Split-phase reversing auto cutout of start field winding	60		3	WAA622 F104	121

² For switch type C315.WAA... the terminal lugs S3D.D625 are additionally specify. Number corresponds to termination points.

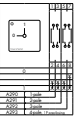

CONTROL SWITCHES AND LOAD SWITCHES

Switch functions (numerically sorted)

Program	Page	Program	Page	Program	Page	Program	Page	Program	Page	Program	Page
A004 F778	117	WAA207 F169	109	A252	114	A326	109	WAA468 F294	121	A575	110
WAA005 F781	117	WAA208 F062	109	WAA253 F079	114	WAA330 F001	112	A476	113	A576	110
A007 F785	117	A210	110	WAA254 F110	114	WAA331 F001	112	A477	114	WAA577 F743	110
WAA008 F788	117	A210 F085	111	WAA255 F111	114	WAA332 F001	112	WAA478 F078	114	A578	110
WAA010 F791	117	A211	110	A260	115	WAA339 F001	112	WAA480 F075	115	A585	110
WAA017 F719	118	A211 F085	111	A261	115	WAA341 F070	109	WAA481 F109	116	A586	110
WAA019 F719	118	A212	110	WAA262 F002	116	A342	109	WAA482 F002	116	WAA587 F254	110
A023 F793	117	A212 F085	111	WAA263 F003	116	A343	109	WAA484 F076	113	WAA588 F254	110
A025 F795	117	A213	110	WAA264 F004	116	A344	109	WAA485 F077	114	WAA590 F700	109
WAA028 F077	118	A214	111	WAA265 F005	116	WAA345 F070	109	WAA486 F075	115	WAA591 F700	109
WAA036 F060	118	A215	111	A270	113	A346	109	WAA487 F109	116	WAA592 F700	109
WAA037 F057	118	A216	111	A271	113	WAA347 F070	109	WAA489 F076	113	WAA593 F700	109
A038	118	A218	111	WAA272 F078	114	A348	109	WAA490 F077	114	WAA622 F104	121
WAA039 F060	118	A219	111	WAA273 F079	114	A361	111	WAA491 F075	115	WAA639 F013	115
WAA046 F058	118	A220	109	WAA274 F110	114	A362	111	A510	111	WAA649 F009	117
A048	118	A221	109	WAA275 F111	114	WAA363 F071	111	WAA511 F216	111	WAA653 F070	109
WAA100 F169	109	A222	109	A280	115	WAA364 F071	111	WAA512 F216	111	WAA654 F070	109
WAA101 F169	109	A223	109	A281	115	A369	109	WAA513 F216	111	WAA664 F071	111
WAA102 F169	109	A228	120	WAA282 F002	116	A370	109	WAA514 F216	111	WAA673 F072	110
WAA103 F169	109	A230	113	WAA283 F003	116	A371	109	WAA515 F216	111	A710	111
WAA120 F026	110	A231	113	WAA284 F004	116	A372	109	WAA520 F743	110	A711	111
WAA121 F026	110	A232	114	A290	109	WAA373 F072	109	WAA521 F743	110	A712	111
WAA122 F026	110	A233	114	A291	109	WAA374 F072	109	WAA522 F743	110	A713	111
WAA123 F026	110	WAA234 F110	114	A292	109	WAA375 F072	110	WAA523 F743	110	A714	112
WAA174 F022	118	WAA235 F111	114	A293	109	WAA376 F072	109	A530	110	A715	112
A175	118	WAA236 F010	115	WAA294 F057	111	A400	120	WAA531 F254	110	A720	110
A176	119	WAA237 F011	115	A295	110	A401	120	WAA532 F254	110	A721	110
WAA177 F121	119	WAA238 F012	115	A296	110	WAA402 F121	120	WAA533 F254	110	A722	110
A178	119	WAA239 F013	115	WAA297 F026	110	A410	121	A540	112	A723	110
WAA179 F025	119	A240	115	WAA299 F057	111	WAA413 F112	121	WAA541 F322	113	A730	115
WAA182 F121	119	A241	115	A310	112	WAA416 F080	121	WAA542 F322	113	A731	115
WAA183 F024	119	A242	116	A311	112	A419	121	A543	113	A750	115
WAA190 F990	120	A243	116	A312	112	A425	121	WAA545 F009	113	A751	115
WAA192 F990	120	A244	116	WAA313 F001	112	WAA426 F120	121	A550	113	A789	119
A200	109	WAA245 F005	116	WAA314 F075	112	A440	120	WAA551 F007	113	WAA790 F121	119
A201	109	WAA246 F006	116	WAA315 F001	112	A441	120	WAA552 F007	113	A791	119
A202	109	WAA247 F007	117	A320 F341	111	A442	121	A565	112	A795	110
A203	109	WAA248 F008	117	A321 F341	111	WAA444 F073	121	WAA566 F216	112	WAA913 F071	111
A204 F169	109	WAA249 F009	117	A322 F341	111	WAA451 F073	120	WAA567 F216	112	WAA963 F071	112
A205 F169	109	A250	113	A324	109	WAA457 F109	120	WAA568 F216	112	WAA972 F072	110
WAA206 F169	109	A251	113	WAA325 F056	109	A466	120	WAA570 F743	110	WAA973 F072	110

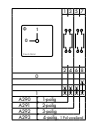

Switch functions

WAA375

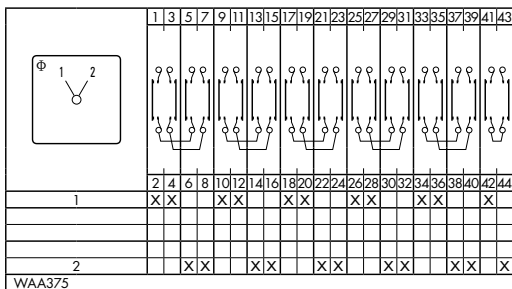

WAA673

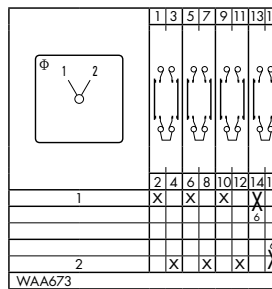

WAA972

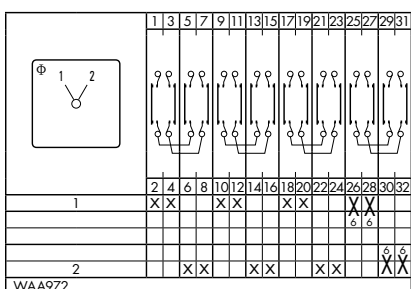

A530, WAA531, WAA532, WAA533

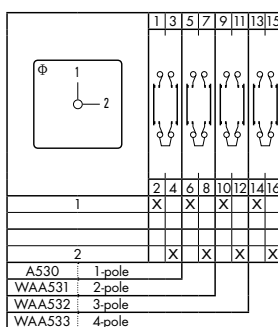

WAA520, WAA521, WAA522, WAA523, WAA570

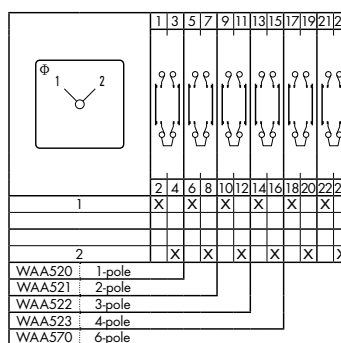

WAA120, WAA121, WAA122, WAA123

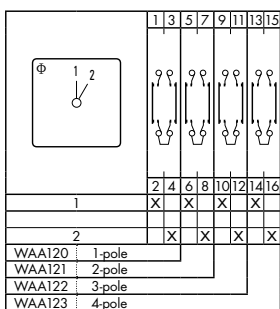

A295, A296, WAA297

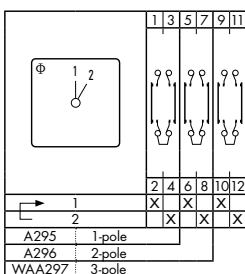

A720, A721, A722, A723

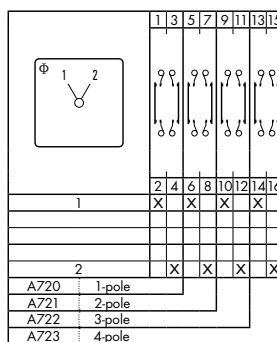

WAA973

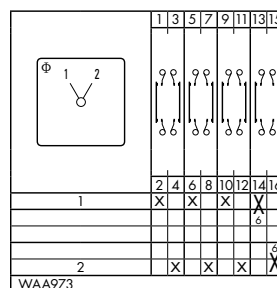

A585, A586, WAA587, WAA588

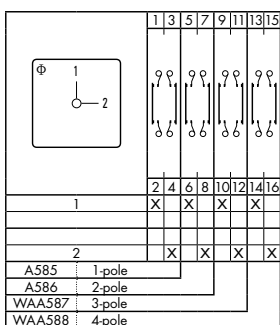

A575, A576, WAA577, A578

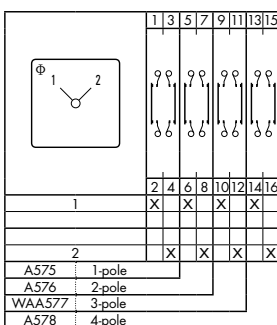

A795

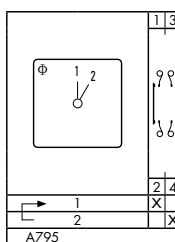

A210, A211, A212, A213

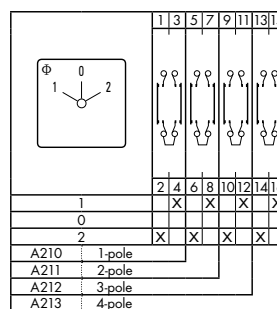

Switch functions



Switch functions

A361

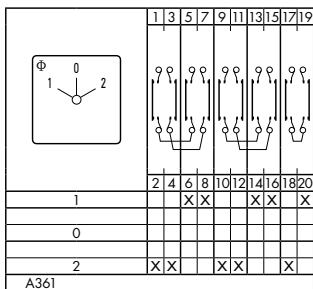

A362, WAA364

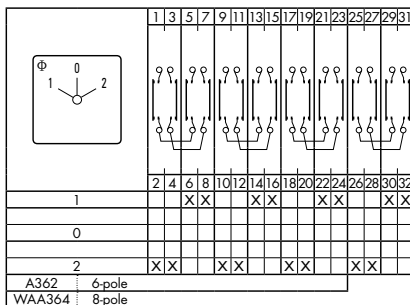

WAA363

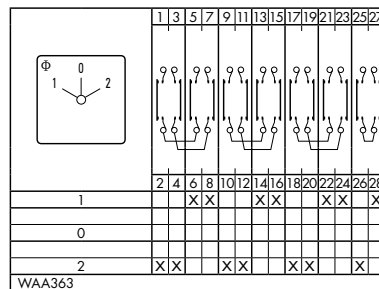

WAA913

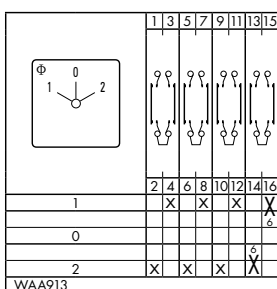

WAA664

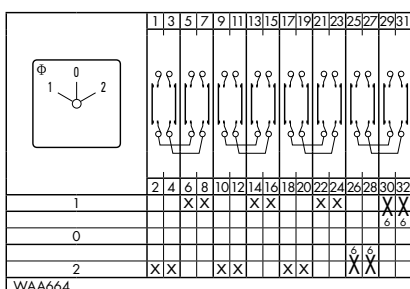

A210
F085

A211
F085

A212
F085

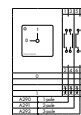
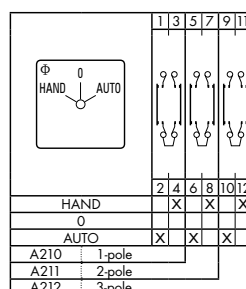

A218, A219

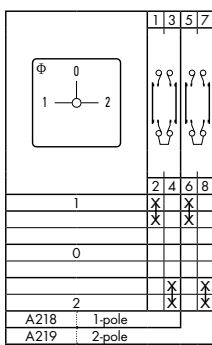

WAA299

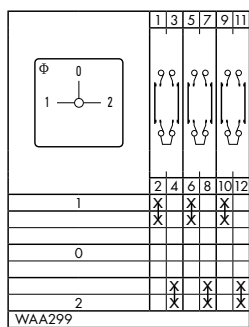

WAA294

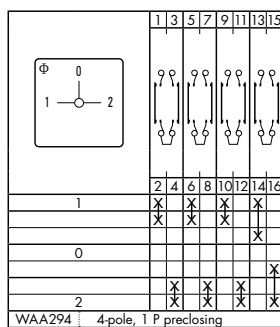

A510, WAA511, WAA512, WAA513

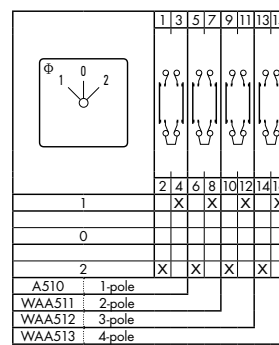

A214, A215, A216

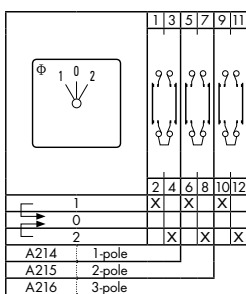

WAA514, WAA515

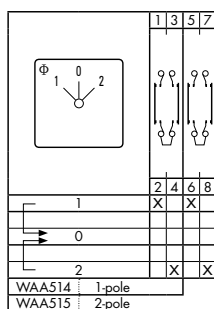

A320
F341

A321
F341

A322
F341

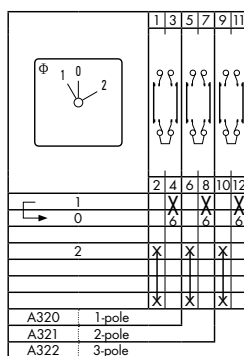

A710, A711, A712, A713

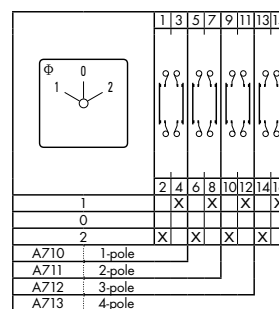

Switch functions

WAA963

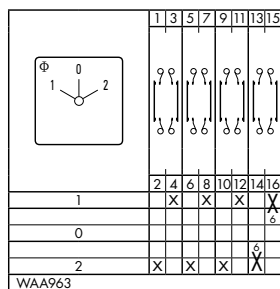

A714, A715

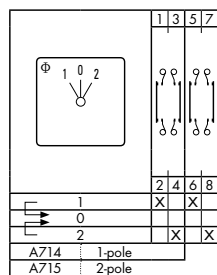

WAA565, WAA566, WAA567, WAA568

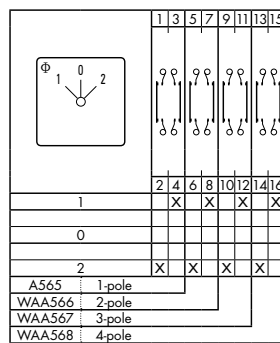

A310

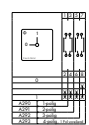
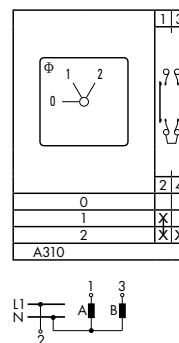

A312

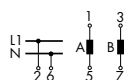
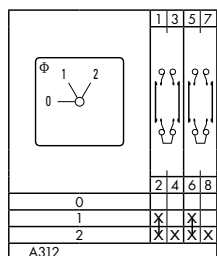

WAA314

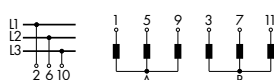
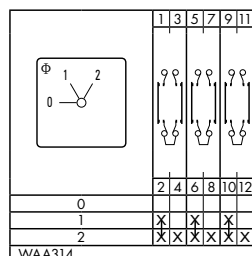

A311

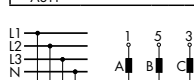
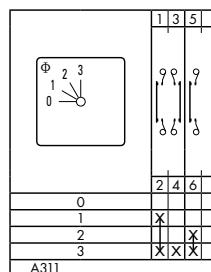

WAA313

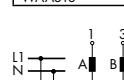
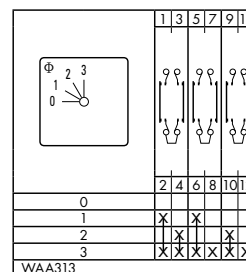

WAA315

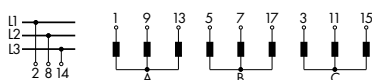
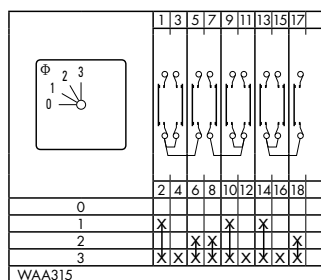

WAA330, WAA331, WAA332

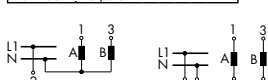
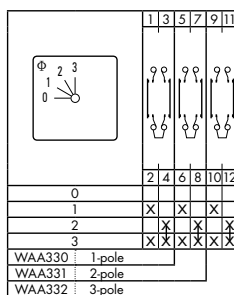

WAA339

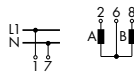
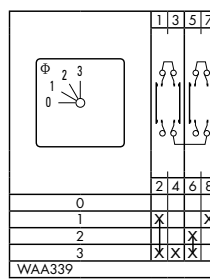

A540

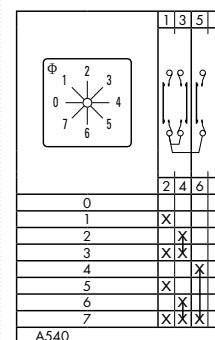

Switch functions

WAA541

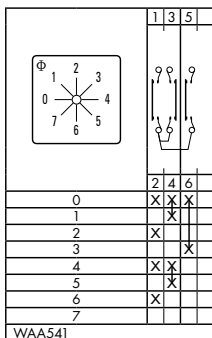

WAA542

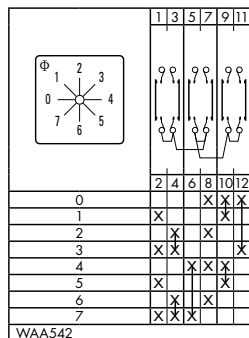

A550

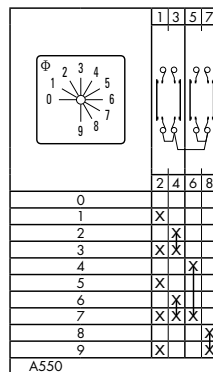

WAA551

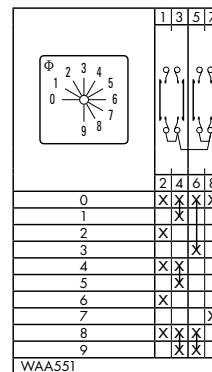

WAA552

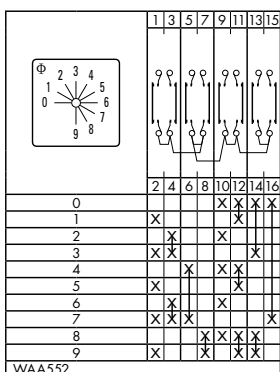

A543

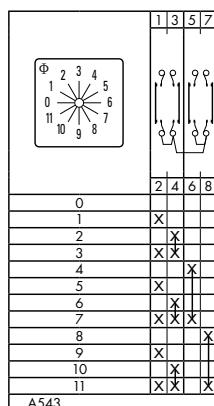

WAA545

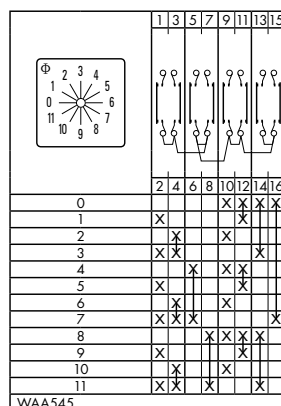

A230

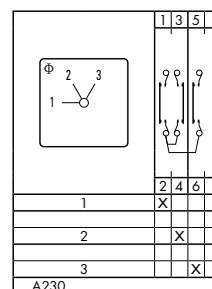

A250

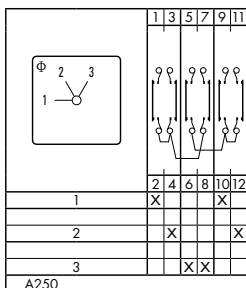

A270

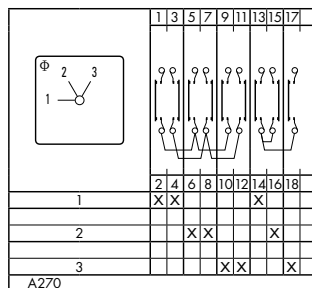

A476, WAA484

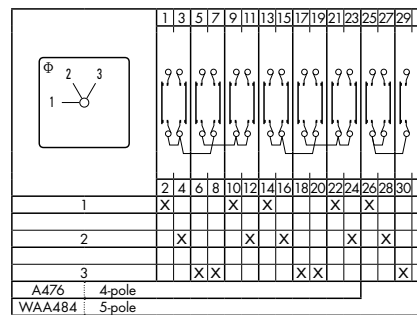

WAA489

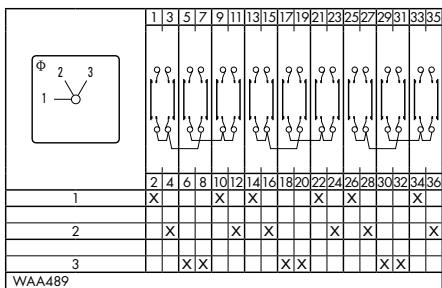

A231, A251, A271

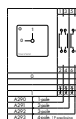
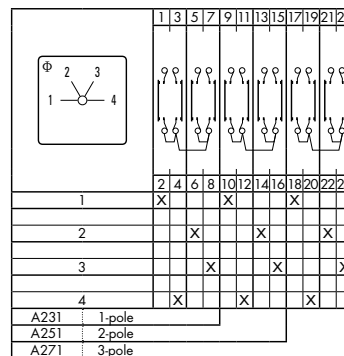

Switch functions

A477, WAA485, WAA490

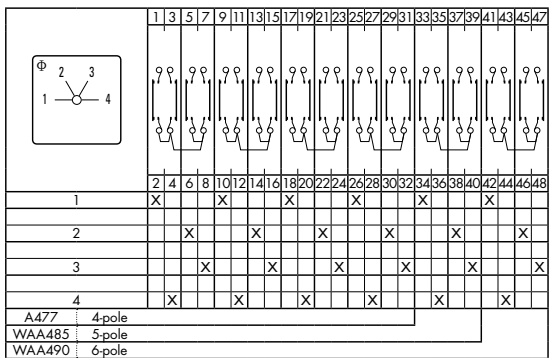

A232, A252, WAA272, WAA478

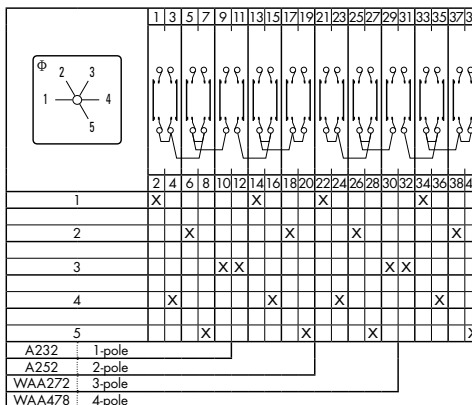

A233, WAA253

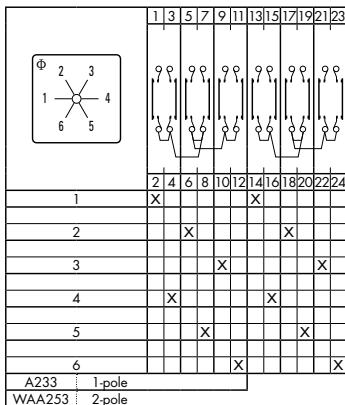

WAA273

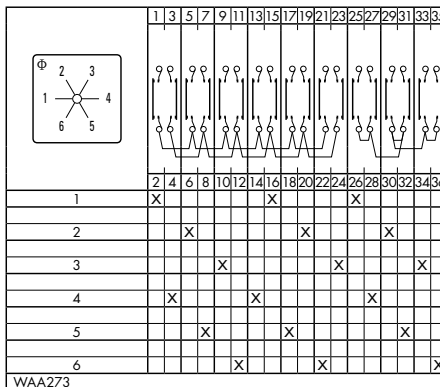

WAA234, WAA254, WAA274

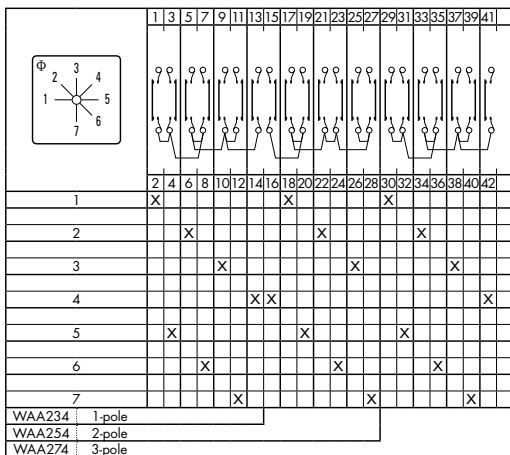

WAA235, WAA255, WAA275

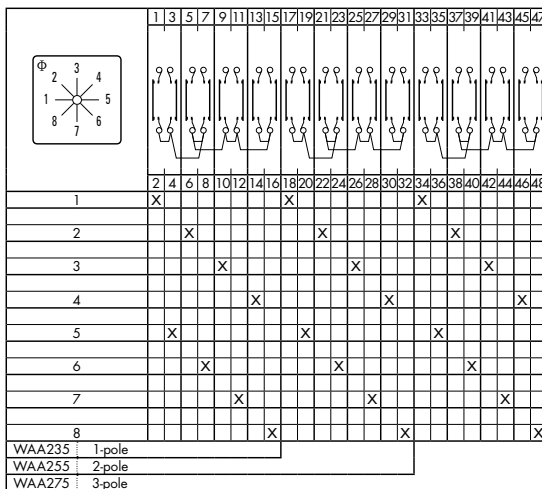

Switch functions

WAA236

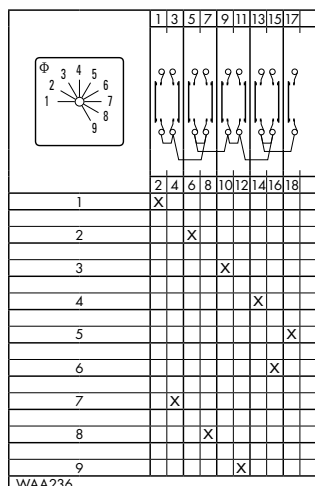

WAA237

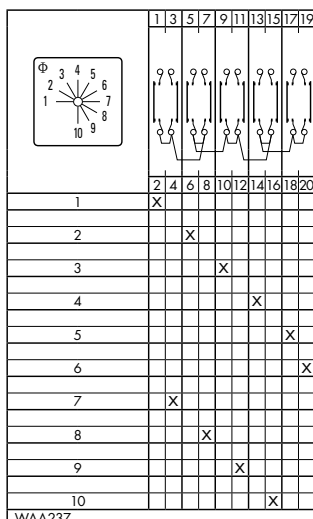

WAA238

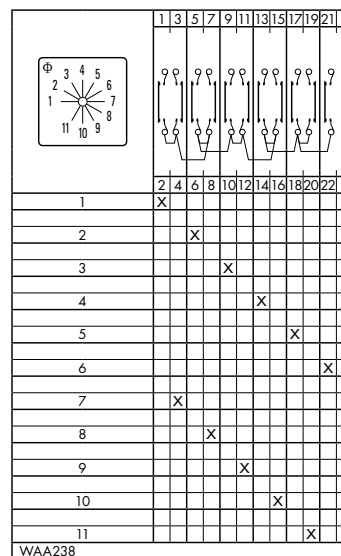

WAA239, WAA639

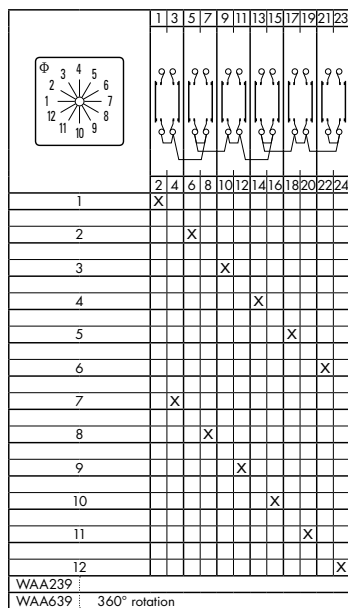

A730, A750

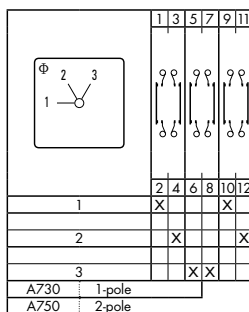

A731, A751

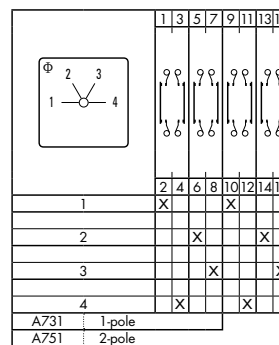

A240, A260, A280, WAA480, WAA486, WAA491

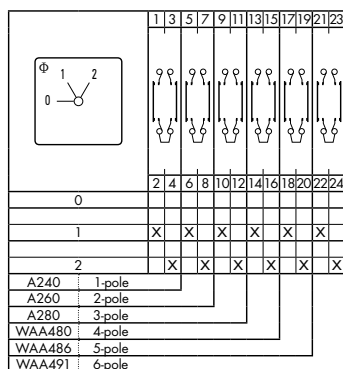

A241, A261

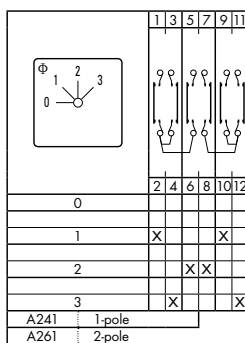

A281

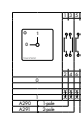
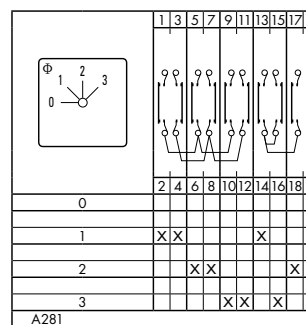

Switch functions

WAA481

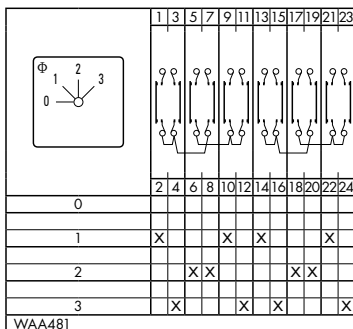

WAA487

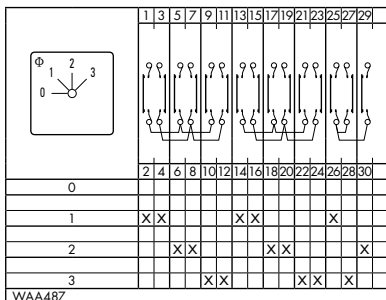

A242, WAA262, WAA282, WAA482

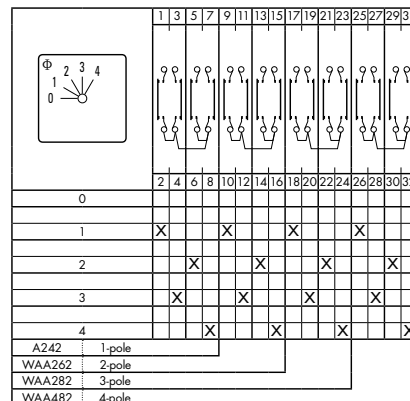

A243, WAA263, WAA283

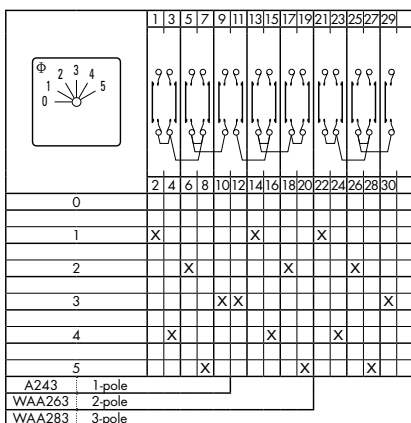

A244, WAA264, WAA284

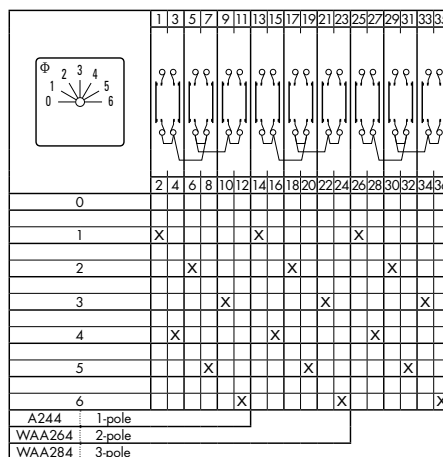

WAA245

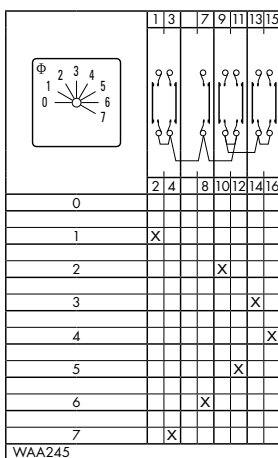

WAA265

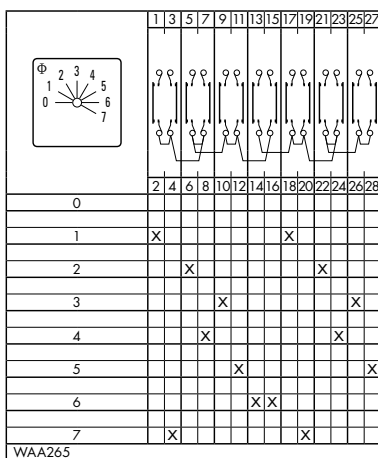

WAA246

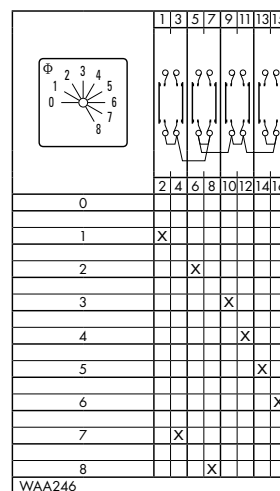

Switch functions

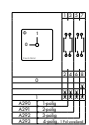

Switch functions

WAA247

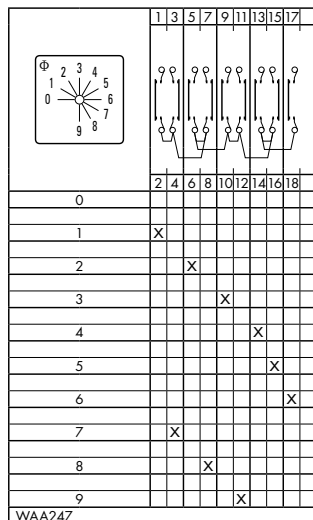

WAA248

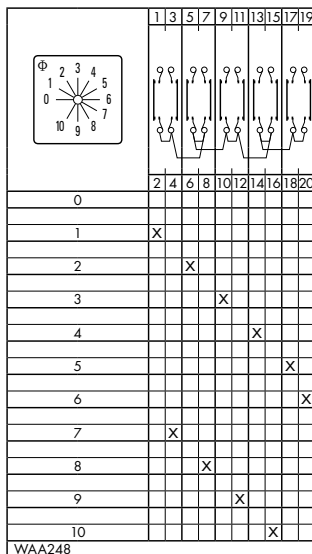

WAA249, WAA649

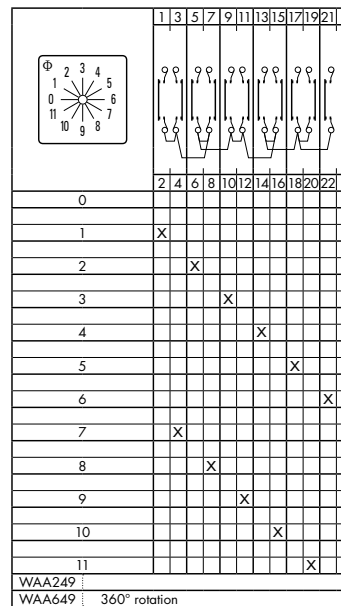

A023
F793

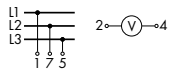
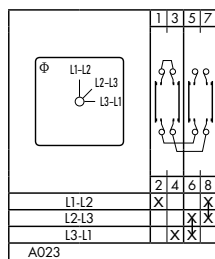

A025
F795

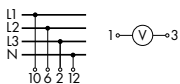
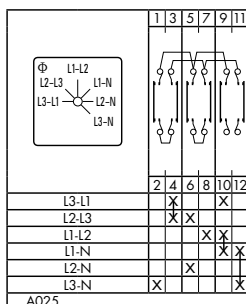

A004
F778

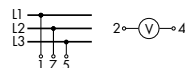
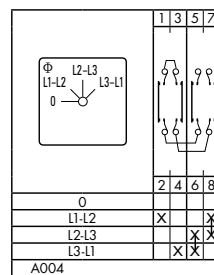

WAA005

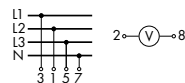
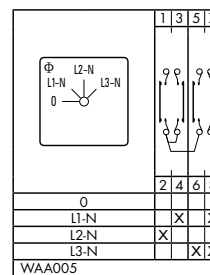

A007
F785

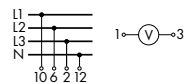
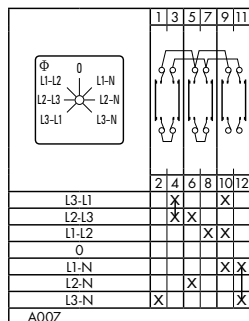

WAA008

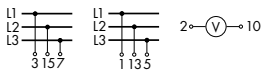
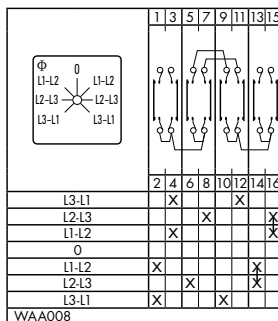

WAA010

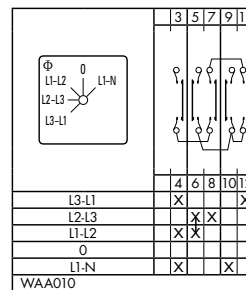

Switch functions

WAA046

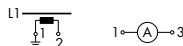
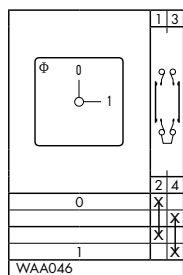

WAA017
F719

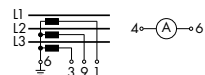
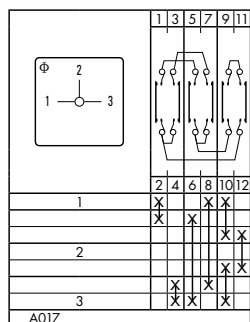

A048

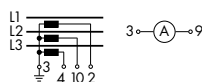
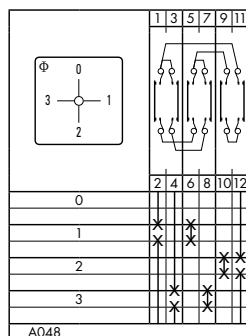

WAA036

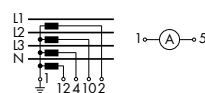
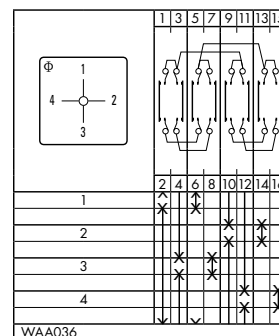

WAA037

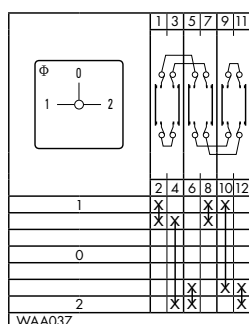

WAA019

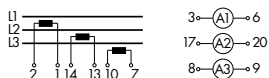
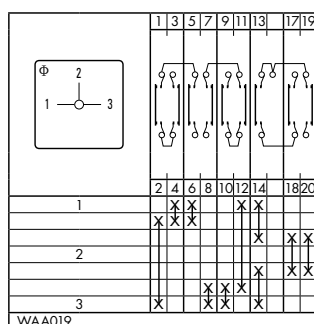

A038

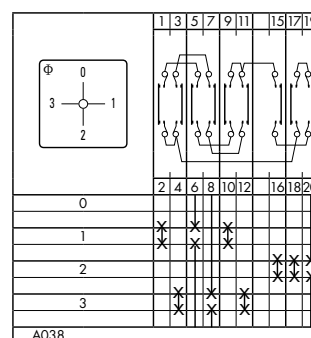

WAA039

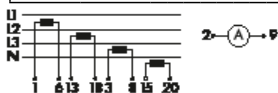
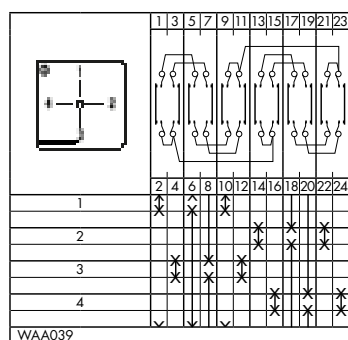

WAA028

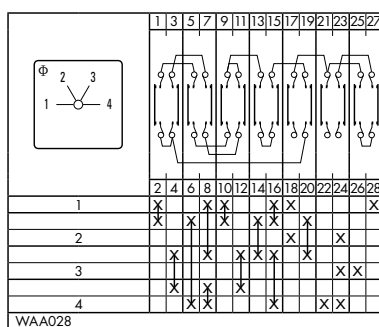

WAA174

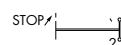
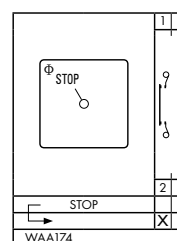

A175

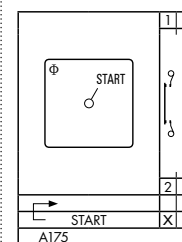

Switch functions

A176

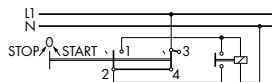
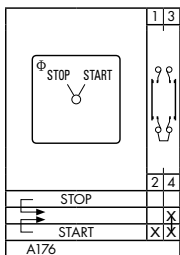

WAA183

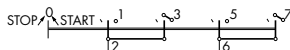
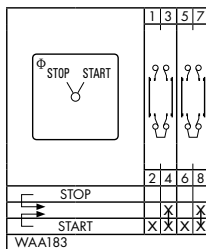

A178

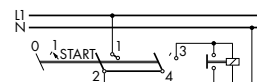
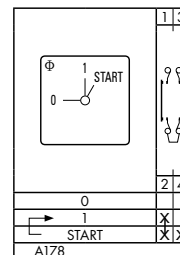

WAA177

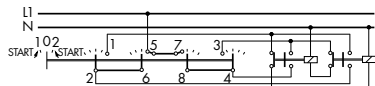
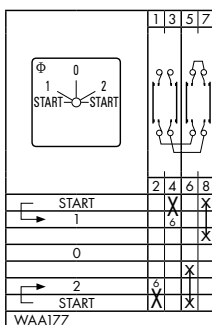

WAA182

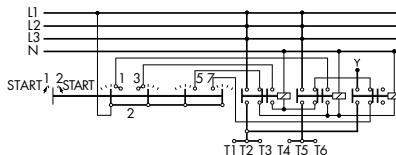
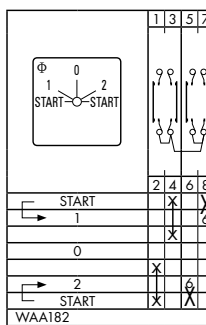

A789

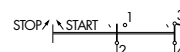
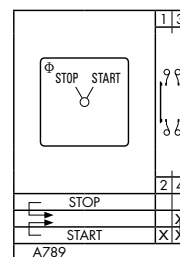

A791

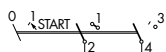
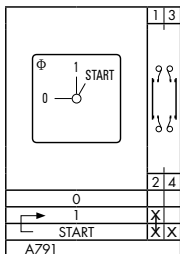

WAA790

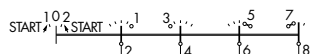
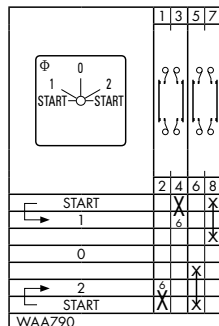

WAA179

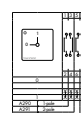
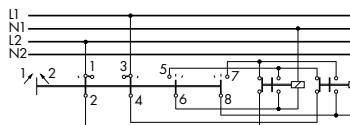
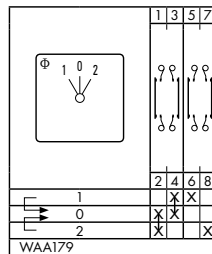

Switch functions

WAA190

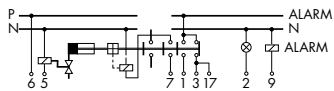
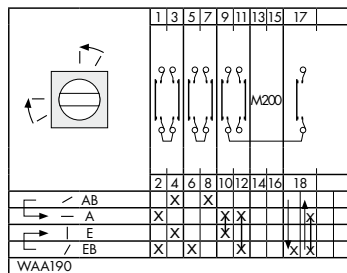

WAA192

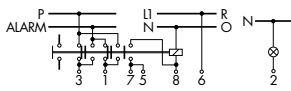
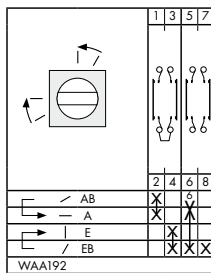

A400, A401

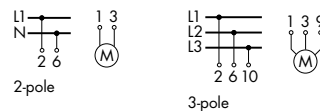
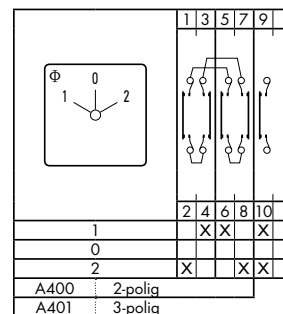

A228

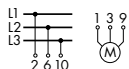
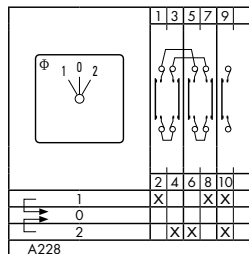

WAA402

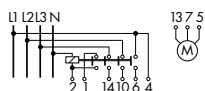
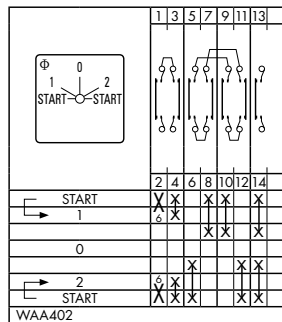

WAA451

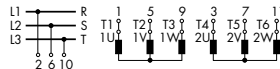
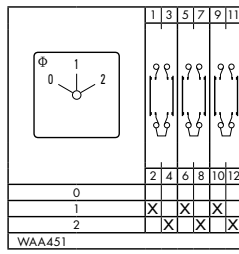

WAA457

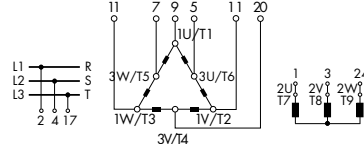
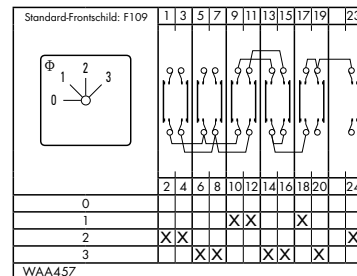

A440

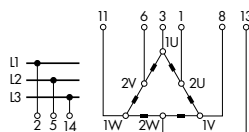
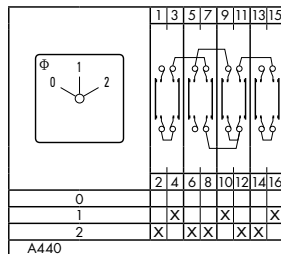

A441

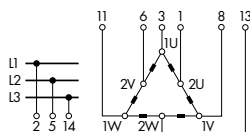
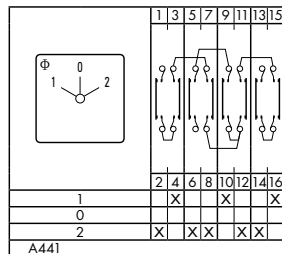

A466

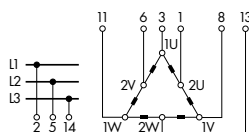
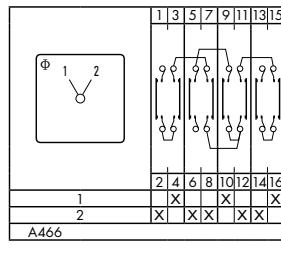

Switch functions



Switch functions

A442

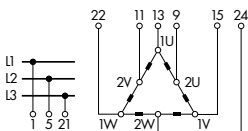
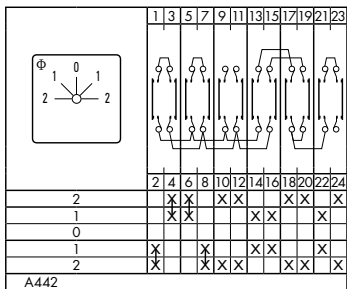

WAA444

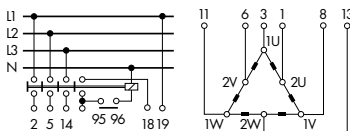
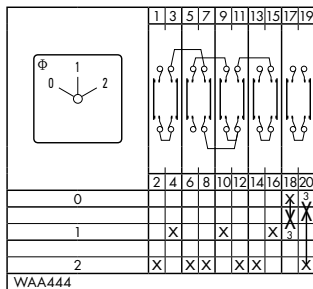

WAA468

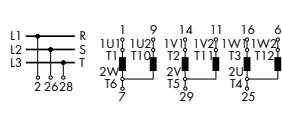
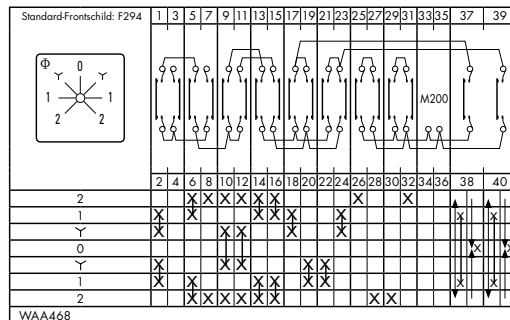

A410

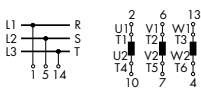
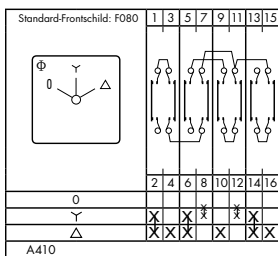

WAA413

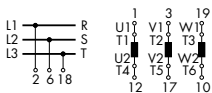
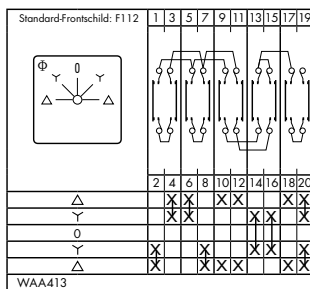

WAA416

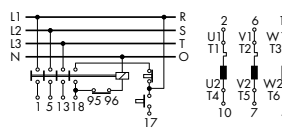
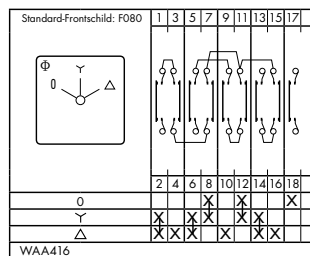

A419

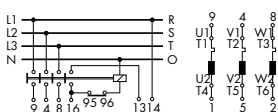
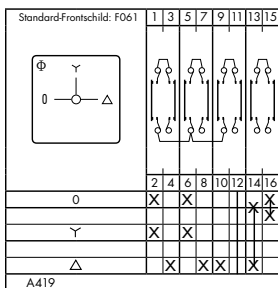

A425

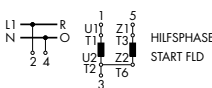
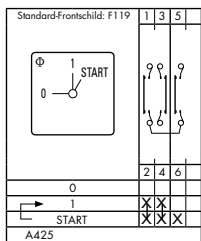

WAA426

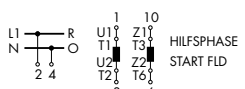
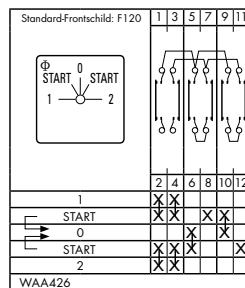

WAA622

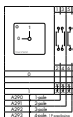
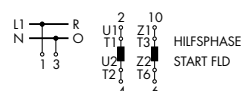
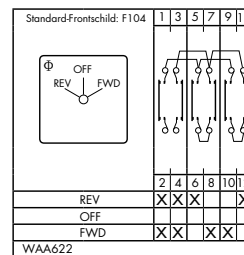

CONTROL SWITCHES AND LOAD SWITCHES

2- or 4-hole panel mounting, IP 40
 2- or 4-hole panel mounting, IP 66
 2-hole panel mounting, IP 65

E, E-V, ER
 EF, EF-V, ERF
 E22, E22-V

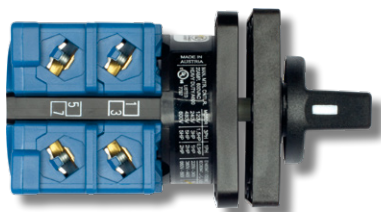

For front mounting you have various options available. Type „ER.“ for installation with additional rear Mounting plate. „-V“ indicates that the terminals are rotated 90° clockwise.

	CGD4-1 CAD4-1 CG4.. CA4.. CH6	CH10, CA10, CA10S, CH11 CH16, CG8, CA11, CA20 CA20S, CA25, CA25S CAD11, DH10, DH11	CH10B, CH16B, CA10B CA11B, CA20B, CA25B, CG8B DH10B, DH11B, CA40, CA40S CA50, CA50S, CA63, CA63S	CA40C CA50C CA63C C80 C125 C315
Size	S00	S0	S1	S2/S3
2-hole, IP 40	E E-V			
2-hole, IP 66	EF EF-V			
4-hole, IP 40		E, ER ¹ E-V	E, ER ¹ E-V	E, ER
4-hole, IP 66		EF, ERF ¹ EF-V	EF, ERF ¹ EF-V	EF, ERF
2-hole, IP 65		E22 E22-V		

	CG4..	CA4..	CH6	CH10, CH11 CH16	CH10B, CH11B CH16B
A	30	30	30	48	64
B	28	29,5	46	46	56
C	4	4	4	4	4
D3	3,2	3,2	3,2	5	5
E1	-	-	-	36	48
E2	20	20	20	30	-
M1 ⁴	1	1	1	0	0
D2					
E, E-V, ER	8-11	8-11	8-11	8-15	10-15
EF, EF-V, ERF	8-11	8-11	8-11	15-19	19-22
E22, E22-V	-	-	-	11-15	-

	CG8	CG8B	CA10, CA10S, CA11 CAD11	CA10B, CA11B CA20B
A	48	64	48	64
B	38	48	43	56
C	4	4	4	4
D3	5	5	5	5
E1	36	48	36	48
E2	30	-	30	-
M ²	-	-	4,5	5
M1 ⁴	0	0	0	0
D2				
E, E-V, ER	8-15	10-15	8-15	10-15
EF, EF-V, ERF	15-19	19-22	15-19	19-22
E22, E22-V	11-15	-	11-15	-

	DH10, DH11	DH10B, DH11B	CA20 CA20S	CA25 CA25S	CA25B
A	48 (64 ²)	64	48	48 (64 ²)	64
B	42	56	45	46	56
C	4	4	4	4	4
D3	5	5	5	5	5
E1	36 (48 ²)	48	36	36 (48 ²)	48
E2	-	-	30	30	-
M ²	5,5	-	4,5	5,5	5,5
M1 ⁴	0	0	0	0	0
D2					
E, E-V, ER	8-15	10-15	8-15	8-15	10-15
EF, EF-V, ERF	15-19	19-22	15-19	15-19	19-22
E22, E22-V	11-15	-	11-15	11-15	-

	CA40, CA40S, CA50 CA50S, CA63, CA63S	CA40C- CA63C ⁶	C80 ⁶	C125 ⁶ C200-4 ⁶	C315 ⁶
A	64 (88 ²)	88	88	88	130
B	55,5x64	55,5x64	84	88 ³	126 ³
C	4	5,5	5,5	5,5	7
D3	5 (6 ²)	6	6	6	7
E1	48 (68 ²)	68	68	68	104
M	7,6 ²	7,6 ²	9,4 ²	9,4 ² (34,5 ³)	11,9 ²
M1 ⁴	0	0	0	0	0
D2					
E, E-V, ER	10-15	13-17	13-17	13-17	15,5-20
EF, EF-V, ERF	19-22	26-30	26-30	26-30	22-25
E22, E22-V	-	-	-	-	-

Dimension L on page 129

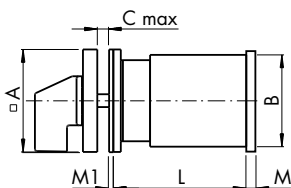

E, EF for CG4, CH6
 E-V, EF-V for CA4
 E22 for CG8
 E22-V for CH10-CH16, CA10-CA25, CAD11/12

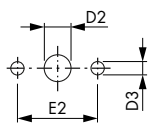

E, EF for CA4
 E-V, EF-V for CG4, CH6
 E22-V for CG8
 E22 for CH10-CH16, CA10-CA25, CAD11/12

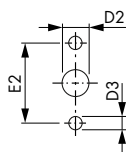

E, E-V, EF, EF-V, ER, ERF, size S0 - S3
 For Face plate and rear mounting panel

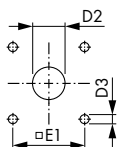

¹ Not for CG.. and CH.., because of the connection direction from behind. | ² Dimensions for ER and ERF rear mounting panel. | ³ Additional dimension for terminal lugs see page 122
⁴ Additional length for EF. | ⁵ C200-4 with rear mounting panel (incl. additional latching mechanic) | ⁶ Shipment without mounting screws.



Single hole mounting 16 / 22 / 30 mm, IP 66, IP 69k (FT. + FH.)

FH., FH.-V, FS., FS.-V, FT., FT.-V

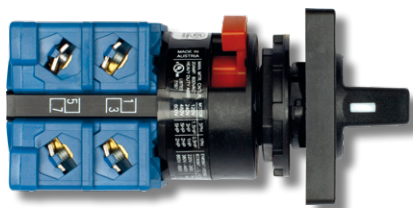

Saving time by using switches with Single hole mounting. This type of mounting is fixed about 5 times faster as a conventional four hole panel mounting. All switches with Single hole mounting have the high degree of protection IP 66. Switches supplied with escutcheon plate or front ring.

An extension ring is enclosed when two drill diameters are specified.

When ordering with the suffix **...-V**, the switches can be supplied with connection terminals rotated 90 ° clockwise.

Design	Size	Face plate- / Ring size	Ø Hole	Code
Front ring	S00	Ø 29,5	16,2 / 22,3	FS1
	S0	Ø 39,4	22,3	FT1
		Ø 39,4	22,3 / 30,5	FT3
Square escutcheon plate	S00	30 x 30	16,2 / 22,3	FS2
	S0	48 x 48	22,3	FT2
			22,3 / 30,5	FT4
S1 ¹	64 x 64	22,3	FH3	
Rectangular escutcheon plate	S00	30 x 39	16,2 / 22,3	FS4
	S0	48 x 59	22,3	FT6
			22,3	FH4
S1 ¹	64 x 78,5	22,3	FH4	

Dimension L on page 129

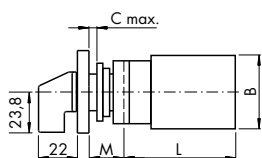

FS1
FT1, FT3

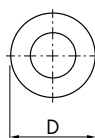

FH3
FS2
FT2, FT4

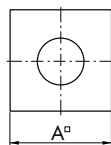

FH4
FS4
FT6

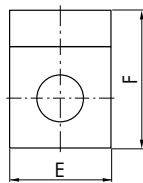

FS1, FS2, FS4

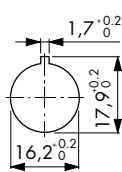

FH3, FH4
FS1, FS2, FS4
FT1, FT2
FT3, FT4, FT6

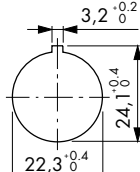

FT3, FT4

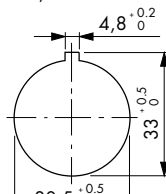

¹ with reinforced stop

	CG4-CGD4-1 CA4-CAD4-1	CH6	CH10, CH11 CH16	CG8
A/E	30	30	48	48
A/E (FH3)			64	64
A/E (FH4)			64	64
B	28 / 29,5 ²	46	46	38
C	5	5	6	6
D	29,5	29,5	39,4	39,4
F	39	39	59	59
F (FH4)			78,5	78,5
M	12,5	12,5	18,2	18,2
M (FH3)			25,2	25,2
M (FH4)			25,2	25,2

² only applies to CA4-CAD4-1

	CA10, CA10S CA11, CAD11	DH10, DH11	CA20, CA20S CA25, CA25S
A/E	48	48	48
A/E (FH3)	64	64	64
A/E (FH4)	64	64	64
B	43	42	46
C	6	6	6
D	39,4	39,4	39,4
F	59	59	59
F (FH4)	78,5	78,5	78,5
M	18,2	18,2	18,2
M (FH3)	25,2	25,5	25,2
M (FH4)	25,2	25,5	25,2



Front panel mounting using larger face plate and handle, IP 40 / IP 66

EG, EGF

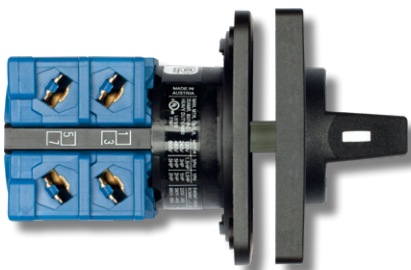

Dimension L on page 129

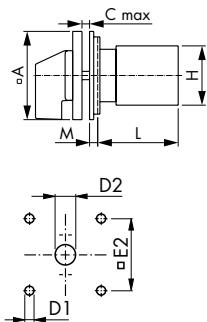

EG – Heavy duty latching panel, degree of protection IP 40

EGF – Heavy duty latching panel, degree of protection IP 66

	CH10, CH11 CH16	CG8	CA10, CA10S CA11, CAD11	DH10, DH11
A	64	64	64	64
C	4	4	4	4
D1	5	5	5	5
D2 (EG)	10–15	10–15	10–15	10–15
D2 (EGF)	19–22	19–22	19–22	19–22
E2	48	48	48	48
H	46	38	43	42
M	6,7	6,7	6,7	6,7

	CA20 CA20S	CA25 CA25S	CA40, CA40S, CA50 CA50S, CA63, CA63S ¹	C80 ¹	C125 ¹
A	64	64	88	130	130
C	4	4	5,5	7	7
D1	5	5	6	7	7
D2 (EG)	10–15	10–15	13–17	15,5–20	15,5–20
D2 (EGF)	19–22	19–22	26–30	22–25	22–25
E2	48	48	68	104	104
H	45	46	55,5 x 64	84	88
M	6,7	6,7	0,5	2	2

¹ Shipment without mounting screws.

Front panel mounting with heavy duty latching and metal shaft, IP 40 / IP 66

KN2, KN1, KD1, KN2F, KN1F, KD1F

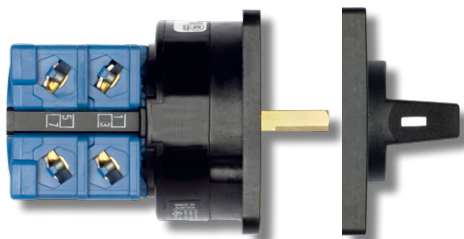

Dimension L on page 129

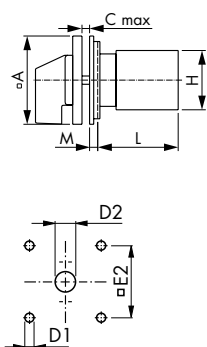

Aluminium shaft, size S0 (48 x 48)

KN2 – Degree of protection IP 40

KN2F – Degree of protection IP 66

Aluminium shaft, size S1 (64 x 64)

KN1 – Degree of protection IP 40

KN1F – Degree of protection IP 66

Square metal shaft, size S1 (64 x 64)

KD1 – Degree of protection IP 40

KD1F – Degree of protection IP 66

Shipment

without

mounting screws ¹

Shipment

without

mounting screws ¹

	KN2 KN2F	CH10, CH11 CH16	CG8	CA10, CA11 CAD11	DH10 DH11	CA20	CA25
A	48	48	48	48	48	48	48
C	4	4	4	4	4	4	4
D1	5	5	5	5	5	5	5
D2 (KN2)	8–19	8–19	8–19	8–19	8–19	8–19	8–19
D2 (KN2F)	15–19	15–19	15–19	15–19	15–19	15–19	15–19
E2	36	36	36	36	36	36	36
H	46	38	43	42	45	46	46
M	5,2	5,2	5,2	5,2	5,2	5,2	5,2

	KN1, KN1F KD1, KD1F	CH10, CH11 CH16	CG8	CA10, CA11 CAD11	DH10, DH11	CH10B CH16B
A	64	64	64	64	64	64
C	4	4	4	4	4	4
D1	5	5	5	5	5	5
D2 (KN1/KD1)	10–22	10–22	10–22	10–22	10–22	10–22
D2 (KN1F/KD1F)	19–22	19–22	19–22	19–22	19–22	19–22
E2	48	48	48	48	48	48
H	46	38	43	42	56	56
M	4,7	4,7	4,7	4,7	7	7

Square shaft KD1, KD1F

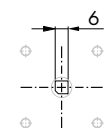

	KN1, KN1F KD1, KD1F	CA10B CA11B CA20B	DH10B DH11B	CA20	CA25	CA25B	CA40 CA50 CA63
A	64	64	64	64	64	64	64
C	4	4	4	4	4	4	4
D1	5	5	5	5	5	5	5
D2 (KN1/KD1)	10–22	10–22	10–22	10–22	10–22	10–22	10–22
D2 (KN1F/KD1F)	19–22	19–22	19–22	19–22	19–22	19–22	19–22
E2	48	48	48	48	48	48	48
H	56	56	45	46	56	56	55,5 x 64
M	7	12	4,7	4,7	7	7	7

¹ Recommendation: 4 x M4 x 15 or Kit: SOD M280 N



Front panel mounting with round shafts or mosaic mounting

E9-E94



- E9 – 2-hole panel mounting, round shaft Ø 6
- E91 – 2-hole panel mounting, round shaft Ø 6,35
- E92 – 4-hole panel mounting Siemens-Mosaik 30 mm grid depth
- E93 – 2-hole panel mounting
Subklew-, Kreuzenbeck-, Symo-Mosaik
28 mm 25 mm 25 mm
- E94 – 2-hole panel mounting Mauell-Mosaik 30 mm grid depth

E9, E91

Dimension L on page 129

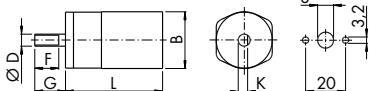

E92

Dimension L on page 129

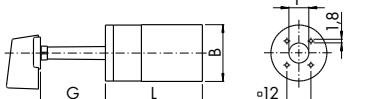

E93, E94

Dimension L on page 129

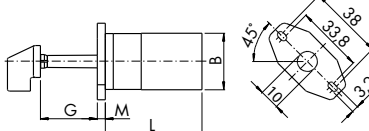

	CG4..., CGD4-1	CA4..., CAD4-1	CH6
B	28	29,5	46

	CG4..., CA4..., CH6				
	E9	E91	E92	E93	E94
D	6	6,35			
F	12	12,8			
G	15,4	17,4	32,5	28,5	32,5
K	4,7	5,5			
M				4	

Front panel mounting with protective cover

EC., ED..

Protective covers with other mountings: see chapter OPTIONAL EXTRAS.



- EC – 4-hole panel mounting, front IP 40 – rear IP 30
- ED – 4-hole panel mounting + additional shaft seal, front IP 65 – rear IP 30 (CH..-CA25B)
- EC1 – 4-hole panel mounting, front IP 40 – rear IP 42
- ED1 – 4-hole panel mounting + additional shaft seal, front IP 65 – rear IP 42 (CH..B-CA25B)
- ED22 – 2-hole panel mounting, front IP 65 – rear IP 42 (CH10-CH16, CG8, CA10-CA25, CAD..)

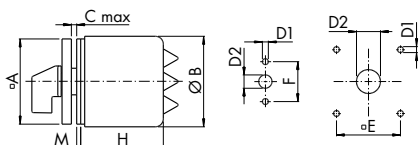

	CH10 CH11 CH16		CG8		CA10 CAD11		CH10B CH16B		DH10 DH11		DH10B DH11B		CA10B		CA11		CA11B		CA20 CA25		CA20B CA25B	
	EC ED	ED22	ED22	ED22	EC ED	ED22	EC ED	EC1 ED1	ED	EC ED	EC ED	EC1 ED1	EC ED	ED22	EC ED	EC1 ED1	EC ED	ED22	EC ED	EC1 ED1		
A	64	48	48	48	48	48	64	64	64	64	64	64	48	48	64	64	64	48	64	64		
B	68	74	74	74	50	74	68	74	68	88	88	74	50	74	88	74	68	74	88	74		
C	EC, EC1	4	4	4	4	4	4	4	4	4	4	4	4	4	4	4	4	4	4	4		
C	ED, ED1, ED22	2	4	4	2	4	4	4	2	4	2	4	2	4	4	4	2	4	4	4		
D1		5	5	5	5	5	5	5	5	5	5	5	5	5	5	5	5	5	5	5		
D2	EC, EC1	8-15			8-15		10-15	10-15	8-15	10-15	10-15	10-15	8-15	10-15	10-15	10-15	8-15	10-15	10-15	10-15		
D2	ED, ED1, ED22	19-22	11-15	11-15	15-19	11-15	19-22	19-22	19-22	19-22	19-22	19-22	15-19	11-15	19-22	19-22	19-22	11-15	19-22	19-22		
E		48			36		48	48	48	48	48	48	36	48	48	48	48	48	48	48		
F		30	30		30								30					30				
M	ED, ED22	2	1,5	1,5	2	1,5	2	2	2	2	2	2	2	1,5	2	2	2	1,5	2	2		
1		74,3	74,3	53,5	74,3		72,7	103	127			73,7	53,5	74,3		73,7		74,3		73,7		
2		74,3	74,3	53,3	74,3		72,7	103	127			73,7	53,5	74,3		73,7		74,3		73,7		
3		94,3	94,3	67,5	74,3		92,7	103	127			73,7	67,5	74,3		93,7		74,3		93,7		
4		103	94,3	67,5	74,3	114,5			127			93,7	81,5	94,3		93,7		94,3		93,7		
5	Measure H according to number of stages		94,3	81,5	94,3	127			139,5			93,7			103		103		103			
6				81,5	94,3	139,5			164,5			103			127		103		127		103	
7						139,5			164,5			164,5			139,5		139,5		139,5		139,5	
8						177			177			177			152		152		152		152	
9												139,5			164,5		164,5		164,5		164,5	
10												152			177		177		177		177	
11												152									152	
12												164,5									164,5	

CONTROL SWITCHES AND LOAD SWITCHES

Base mounting (without door clutch)

VE, VE-V, VE1, VE1-V, VF, VF-V, VE22, VE22V, VF22, VF22V

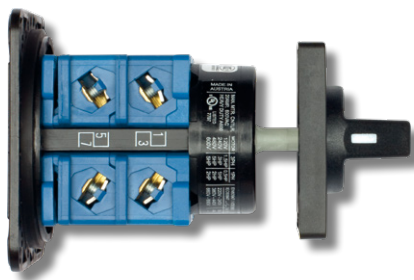

VE – Mounting plate and escutcheon plate with 4-hole panel mounting, IP 40

VE1 – Snap-on base mounting for DIN rail acc. to EN 60715, escutcheon plate with 4-hole panel mounting, IP 40

When ordering with the suffix **...-V**, the switches can be supplied with connection terminals rotated by 90° clockwise. (Not applicable for CA25B – CA63S)

VF – Mounting plate and escutcheon plate with 4-hole panel mounting, Integrated door clutch for enclosures, IP 65

VE22 – Mounting plate and escutcheon plate with 2-hole panel mounting, IP 40

VF22 – Mounting plate and escutcheon plate with 2-hole panel mounting, Integrated door clutch for enclosures, IP 65

Door clutches: see Chapter **Optional extras / Door clutches**

VE/VE-V

Dimension L on page 129

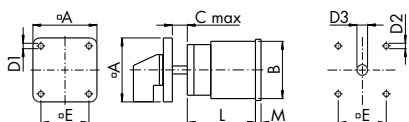

VE1
Size S0, S1

Dimension L on page 129

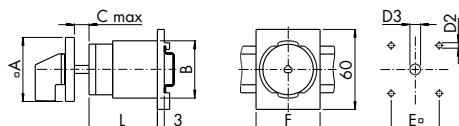

VF/VF-V
Size S0

Dimension L on page 129

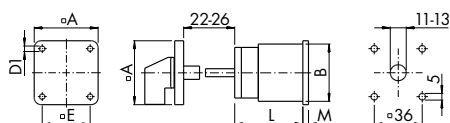

VE22/VE22-V
Size S0

Dimension L on page 129

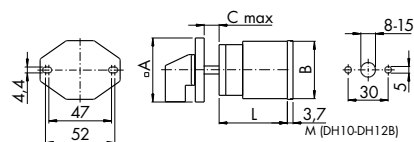

VF22/VF22-V
Size S0

Dimension L on page 129

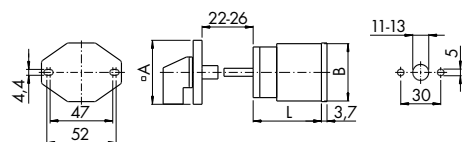

	CH10, CH11 CH16	CG8	CA10, CA10S CA11, CAD11	CA10B, CA20B
A	48 (64 ¹)	48	48	64
B	46	38	43	56
C	10,5	10,5	10,5	13,5
D1	4,1	4,1	4,1	4,1
D2	5	5	5	5
D3	8-15	8-15	8-15	10-15
E	36 (48 ¹)	36	36	48
F	48	48	48	70
M	5,2	2,2	2,2	2,5

	DH10, DH11	DH10B, DH11B
A	48	64
B	42	56
C	10,5	13,5
D1	4,1	4,1
D2	5	5
D3	8-15	10-15
E	36	48
F	48	70
M (VE)	3,2	2,5
M (VE22)	1,9	-
M (VF)	3,2	-
M (VF22)	1,9	-

	CA20 CA20S	CA25 CA25S	CA25B
A	48	48 (64 ¹)	64
B	45	46	56
C	10,5	10,5	13,5
D1	4,1	4,1	4,1
D2	5	5	5
D3	8-15	8-15	10-15
E	36	36 (48 ¹)	48
F	48	48	70
M	2,2	3,2	2,5

	CA40, CA40S CA50, CA50S CA63, CA63S	C80	C125 C200-4	C315
A	64 (88 ¹)	88	88	128
B	55,5x64	84	88	126
C	13,5	16	16	19,3
D1	5,4	5,4	5,4	7
D2	5 (6 ¹)	6	6	7
D3	10-15	13-17	13-17	15,5-20
E	48 (68 ¹)	68	68	104
F	70	-	-	-
M	5,1	8,9	8,9	11,4

¹ Dimensions for rear mounting panel



Base mounting for operation in control cabinet, IP 40

VE1E, VE1F

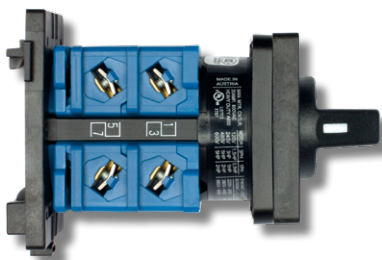

- VE1E – Snap-on base mounting for DIN rail acc. to EN 60715. Escutcheon plate is fixed on switch by screws. Size S00 and S0: recommended to CG4., CG8, CH10–CH16 (Size S1: Switch in mounting E + S1 M999/D-0031)

When ordering with suffix *...-V*, the switches can be supplied with connection terminals rotated by 90 ° clockwise. (Not applicable for CA25B – CA63S)

Dimension L on page 129

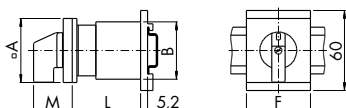

	CG4- CGD4-1	CH10 CH11 CH16	CG8	CA10, CA10S CA11, CAD11	DH10 DH11	CA20 CA20S	CA25 CA25S
A	30	48	48	48	48	48	48
B	28	46	38	43	42	45	46
F	35,5	48	48	48	48	48	48
M	22	28,3	28,3	28,3	28,3	28,3	28,3

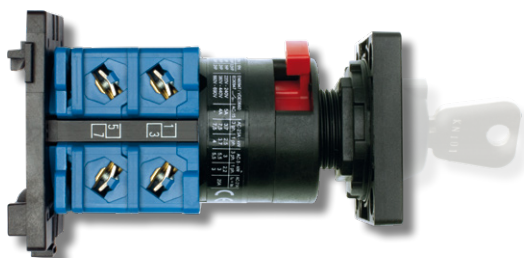

- VE1F – Snap-on base mounting for DIN rail acc. to EN 60715. Escutcheon plate is fixed by Single hole mounting, for use with key-lock devices¹. Size S00 and S0: recommended CG4., CG8, CH10–CH16

Notice:

Suitable key-lock devices see Chapter „Optional extras“

Dimension L on page 129

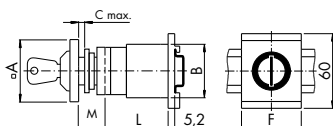

Ordering example size S00:

CG4.A221.*FS2
V750D/2J
S00.M999/D-0030

Ordering example size S0:

CH10.A221.*VE1F
S0.V750D/3J/M1

	CG4- CGD4-1	CH10 CH11 CH16	CG8	CA10, CA10S CA11, CAD11	DH10 DH11	CA20 CA20S	CA25 CA25S
A	30	48	48	48	48	48	48
B	28	46	38	43	42	45	46
F	35,5	48	48	48	48	48	48
M	12,5	25,2	25,2	25,2	25,2	25,2	25,2

¹ Specify optional extras separately

Base mounting 45 mm standard knock-out

VE2, VE21

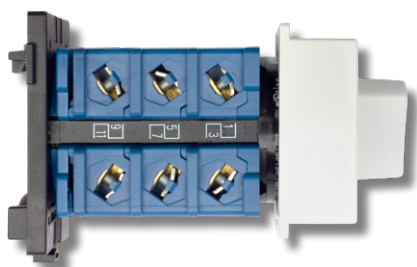

VE2 – Snap-on base mounting for DIN rail acc. to EN 60715 and escutcheon plate for 45 mm standard knock-out.

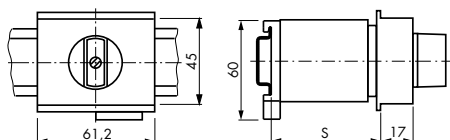

VE2	CH10, CH11 CH16	CG8	DH10, DH11	CA10, CAD11	CA11 CA20	CA25
S min.	Number of stages					
46	1	1	1	3	1	
50	2	2				1
61		3	2	4	2	2
67	3			5		
69					3 ¹	3

¹ Only for CA11



VE21 – Snap-on base mounting for DIN rail acc. to EN 60715 and escutcheon plate for 45 mm standard knock-out. Handle are adjustable in height.

VE21 (CG4.., CA4..)

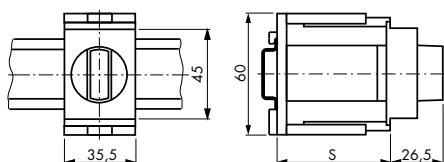

VE21	CG4- CGD4-1	CG8	CH10, CH11 CH16	DH10, DH11
S min.	Number of stages			
44	1	1	1	1
46	2	2		
50			2	
54				2
58	3			
60		3		
64			3	
70				
72		4		3

VE21 (CH10–CH16, CG8, CA10–CA20, DH11/12)
VE21V (CA25)

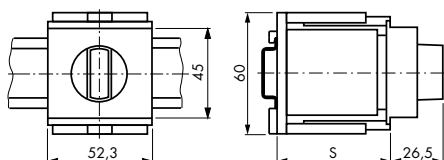

VE21	CA4- CAD4-1	CA10, CAD11	CA20	CA25
S min.	Number of stages			
44	1/2	1/2	1/2	1
46	3	3		2
54	4			
56			3	
60				3
62	5			
66		4/5		
70	6		4	
74		6		4



Dimension L

Stages	CG4- CGD4-1	CA4- CAD4-1	CH6	CH10, CH11 CH16	CH10B CH16B	CG8	CG8B	CA10, CA10S ² CAD11	CA10B	CA11	CA11B
1	38,5	30	46	43,5	48,9	40,7	46,1	33,5	38,9	36,7	42,1
2	50,5	38	60	57,5	62,9	53,4	58,8	43	48,4	49,4	54,8
3	62,5	46	74	71,5	76,9	66,1	71,5	52,5	57,9	62,1	67,5
4	74,5	54	88	85,5	90,9	78,8	84,2	62	67,4	74,8	80,2
5	86,5	62	-	99,5	104,9	91,5	96,9	71,5	76,9	87,5	92,9
6	98,5	70	-	113,5	118,9	104,2	109,6	81	86,4	100,2	105,6
7	110,5	78	-	127,5	132,9	116,9	122,3	90,5	95,9	112,9	118,3
8	122,5	86	-	141,5	146,9	129,6	135	100	105,4	125,6	131
9	-	94	-	155,5	160,9	142,3	147,7	109,5	114,9	138,3	143,7
10	-	-	-	169,5	174,9	155	160,4	119	124,4	151	156,4
11	-	-	-	183,5	188,9	167,7	173,1	128,5	133,9	163,7	169,1
12	-	-	-	197,5	202,9	180,4	185,8	138	143,4	176,4	181,8

Stages	DH10, DH11	DH10B, DH11B	CA20 CA20S ²	CA20B	CA25 CA25S ²	CA25B	CA40, CA40C ³ , CA40S ⁴ CA50, CA50C ³ , CA50S ⁴ CA63, CA63C ³ , CA63S ⁴	C80	C125 C200-4 ¹	C315 ¹ C316 ¹
1	43,5	48,9	37,7	43,1	39	44,4	42,5	61,5	67,5	78,6
2	61	66,4	50,4	55,8	53	58,4	55,2	88	100	117,2
3	78,5	83,9	63,1	68,5	67	72,4	67,9	114,5	132,5	155,8
4	96	101,4	75,8	81,2	81	86,4	80,6	141	165	194,4
5	113,5	118,9	88,5	93,9	95	100,4	93,3	167,5	197,5	233
6	131	136,4	101,2	106,6	109	114,4	106	194	230	271,6
7	148,5	153,9	113,9	119,3	123	128,4	118,7	220,5	262,5	310,2
8	166	171,4	126,6	132	137	142,4	131,4	247	295	348,8
9	183,5	188,9	139,3	144,7	151	156,4	144,1	273,5	327,5	387,4
10	201	206,4	152	157,4	165	170,4	156,8	300	360	426
11	218,5	223,9	164,7	170,1	179	184,4	169,5	326,5	392,5	464,6
12	236	241,4	177,4	182,8	193	198,4	182,2	353	425	503,2

¹ Look for dimensions of bolt terminals on this page. | ² Type supplement S for CA10S, CA20S, CA25S = L + 17,3
| ³ CA40C, CA50C, CA63C = L + 8,2 | ⁴ CA40S, CA50S, CA63S = L + 20

Dimensions of plug-in connection and bolt terminals

CH...-4 (Connection straight 2 x 2,8 or 1 x 6,35)

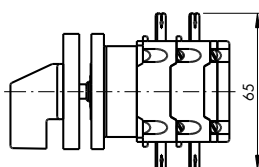

CH...-6 (Connection rotated by 90° clockwise 2 x 2,8 or 1 x 6,35)

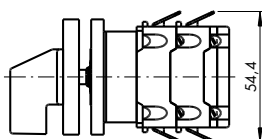

CA4-4 (Connection straight 1 x 2,8)

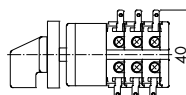

DH...-4 (Connection straight 2 x 2,8 or 1 x 6,35)

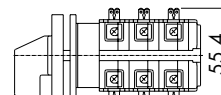

C200-4

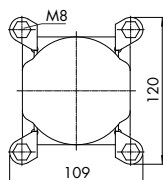

C315, C316

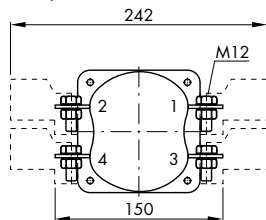

Dimension L



Mounting



Enclosures series with high mechanical strength, oversized wiring space and cover clutch.

KS-, KL-series → with high UV resistance

CS-, CL-series → for aggressive environment such as oil, grease and other chemical substances

There are two knock-outs for metric threads at the top and bottom acc. to EN 50262. A protective earth and neutral terminal per enclosure is included in delivery. Size S0 enclosures are equipped with additional lateral knock-outs and a cover interlock, which allows opening without dismantling the handle and locking cover in one switch position optional.

Without cover interlock

switch-type	Max. Number of stages	Mounting
CG4-CGD4-1, CG6	2	KS3, CS3
CA4-CAD4-1	3	
CA10	6	KS50, CS50
CA11, CA20,	5	
CA25, CG8, CH10-CHR16	4	
CH10-CHR16	2	KL50, CL50
CA10	3	
CA11, CA20, CA25, CG8	2	

With cover interlock (switch open at nine o'clock position)

switch-type	Max. Number of stages	Mounting
CA10	6	KS51, CS51
CA11, CA20,	5	
CA25, CG8, CH10-CHR16	4	
CH10-CHR16	2	KL51, CL51
CA10	3	
CA11, CA20, CA25, CG8	2	

With cover interlock (switch open at twelve o'clock position)

switch-type	Max. Number of stages	Mounting
CH10-CHR16, CA25, CG8	4	KS52, CS52
CA10	6	
CA11, CA20	5	
CH10-CHR16	2	KL52, CL52
CA10	3	
CA11, CA20, CA25, CG8	2	

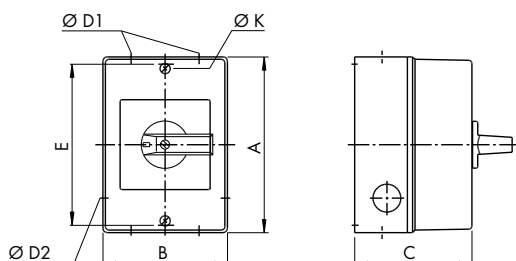

Type	Max. number of stages	Mounting	A	B	C	Conduit entries per	E	K	
						4 x D1	2 x D2		
CA4-CAD4-1	2	KS3	90	70	60	16	-	82	4,2
CG4-CGD4-1	1								
CA4-CAD4-1	3	KS3, CS3	90	70	77	16	-	82	4,2
CG4-CGD4-1	2								
CG6	2								
CA10	4	KS50, KS51, KS52	121	86	80	20/25 ¹	20	110	4,2
CA11	3								
CA20, CA25, CG8	2								
CH10-CHR16	2								
CA10	6	KS50, KS51, CS50, CS51, CS52	121	86	106	20/25	20	110	4,2
CA11, CA20	5								
CA25, CG8	4								
CH10-CHR16	4								
CA10	3	KL50, KL51, KL52	160	85	80	20	20	150	4,2
CA11, CA20	2								
CA25, CG8,	2								
CH10-CHR16	2								

¹ CS.. only 20



Small-sized Plastic enclosures, IP 42 / IP 65

PN., PF.



Compact size and threaded entries.
Optional with built-in lamp. Look at page 142
Inclusive protective earth terminal.

PN1/PN4 – IP42
PF1/PF4 – IP65

CA10

CA11, CA20, CA10B,
CA11B, CA20B, CA25

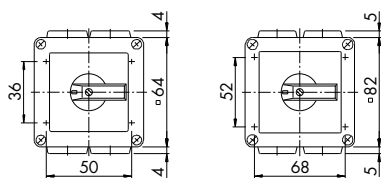

CA40, CA50, CA63

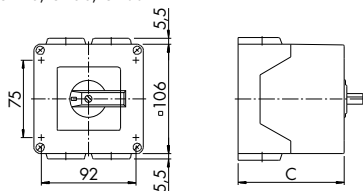

Type	Number of stages	PN1 C	PF1 C	Conduit entries per 4 x
CA10	1	36,6	41,3	M20
	2	45,8	50,8	
	3	55,3	60,3	
	4	64,8	69,8	
CA11, CA20, CA11B, CA20B	1 + 2	59,7	64,7	M20
CA11, CA20, CA10B, CA11B, CA20B	3 + 4 ¹	85,1	90,1	M20
CA25	1 + 2	59,7	64,7	M20
	3	85,1	90,1	
	4	93	98	
Type	Number of stages	PN4 C	PF4 C	Conduit entries per 4 x
CA40, CA50, CA63	1-3	89	94,5	M25
	4-6	132	137,5	

¹ CA10B only for 4 stages



Additional protective earth-/neutral terminal

- SOD.T410.A for CA10
- S1D.T410.A for CA11, CA20, CA10B, CA11B, CA20B, CA25
- S1D.T430.A for CA40, CA50, CA63

Aluminium enclosures, IP 65

GK.



Rugged design for rough environment.
Inclusive a protective earth terminal.

switch-type	Max. Number of stages	With metric thread	without Conduit entries
A11	10	GK1	GK9
CA10	3		
CA11, CA20	2		
CA10B	12		
CA11B, CA20B	10		
CA25B	9		
CA40, CA50, CA63	10		

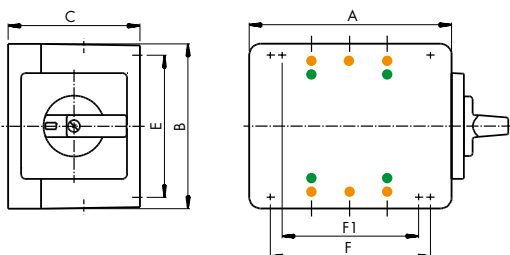

switch-type	Stages	A	B	C	E	F	F1	Conduit entries
CA10, CA11, CA20	3	80	75	57	63	-	52	4 x M20
	2							
CA10B, CA11B, CA20B, CA25B	4	100	100	80	86	66	-	4 x M20
	3							
	2							
A11, CA10B, CA11B, CA20B, CA25B, CA40, CA50, CA63	5	140	140	90	120	93	-	4 x M25
	7							
	6							
	5							
	5							
A11, CA10B, CA11B, CA20B, CA25B, CA40, CA50, CA63	10	200	140	90	93	180	-	6 x M25
	12							
	10							
	9							
	10							

CONTROL SWITCHES AND LOAD SWITCHES

Polycarbonate enclosures

**For use in harsh environment.
Includes base part, cover and cover screw set**

Color: Light gray, RAL 7035
Degree of protection: IP 66/67
Protection class: Ik 08
Insulated, high chemically resistance

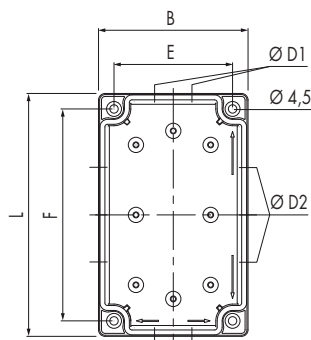
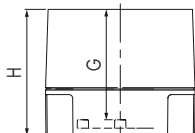

Length x width	Height*	Order number
130 x 80	100	ST4.M311
130 x 130	75	ST4.M212
	100	ST4.M312
180 x 130	125	ST4.M412
	100	ST4.M313
	125	ST4.M413
180 x 180	150	ST4.M513
	125	ST4.M414
255 x 180	150	ST4.M515

*More enclosure heights on request

	B	D1	D2	E	F	G	H	L
ST4.M311	80	1 x 25/16	2 x 32/20	63,5	113,5	86,3	100	130
ST4.M212	130	2 x 25/16	2 x 32/20	113,5	113,5	61,0	75	130
ST4.M312	130	2 x 25/16	2 x 32/20	113,5	113,5	86,2	100	130
ST4.M412	130	2 x 25/16	2 x 32/20	113,5	113,5	111,3	125	130
ST4.M313	130	2 x 32/20	3 x 25/16	113,5	163,5	86,2	100	180
ST4.M413	130	2 x 32/20	3 x 25/16	113,5	163,5	111,3	125	180
ST4.M513	130	2 x 32/20	3 x 25/16	113,5	163,5	135,9	150	180
ST4.M414	180	3 x 25/16	3 x 32/20	163,5	163,5	111,3	125	180
ST4.M515	180	3 x 32/20	3 x 25/16 + 2 x 32/20	163,5	238,5	135,9	150	255

Drill pattern for switch installation, symmetric



Drill holes for	Order number
Single hole mounting \varnothing 22,5 mm	ST4.T999/D-1402
Single hole mounting \varnothing 30 mm	ST4.T999/D-1403

Drill holes for	Order number
Four hole mounting, escutcheon plate 48 x 48	ST4.T999/D-1400
Four hole mounting, escutcheon plate 64 x 64	ST4.T999/D-1401
Four hole mounting, escutcheon plate 88 x 88	ST4.T999/D-1404...

Drill holes for	Order number
Switch with half-cylinder lock V755/..	ST4.T999/D-1320

Drill holes for	Order number
Switch with half-cylinder lock V765/.. only for enclosures with dimensions L from 180 mm	ST4.T999/D-1600

Ordering example:
ST4.M212
ST4.T999/D-1400



DIN rails

ST5.A000.03
ST5.A000.02

ST5.A000.04
ST6.A000.97

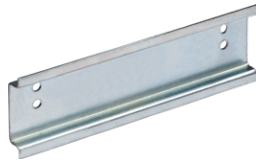

Dimensions	For enclosures with width
65	80
115	130
165	180
240	255

7,5 mm root face

Mounting panel

ST5.A000.54
ST5.A000.64
ST5.A000.66

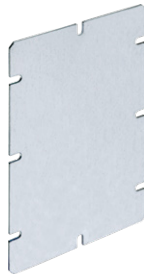

L x W 148 x 98, for enclosures with L x W 180 x 130
L x W 148x148, for enclosures with L x W 180 x 180
L x W 223x148, for enclosures with L x W 255 x 180

2 mm steel plate

Protective earth/Neutral terminals

ST5.A022 + ST1.A100.73
ST5.A022/N + ST1.A100.73



Protective earth terminal + spacer for DIN rail
Neutral terminal + spacer for DIN rail

ST5.A024
ST5.A024/N



Protective earth terminal isolated for mounting panel
Neutral terminal isolated for mounting panel

Max. Permissible Wire Gage (use copper wire only)

Single-core or stranded wire	6 mm ²
Flexible wire	6 mm ²
Flexible wire with sleeving in accordance with DIN 46228	4 mm ²
Wire stripping	12 mm
Tightening torque	1,3 Nm

Hinge unit

ST4.A000.SP

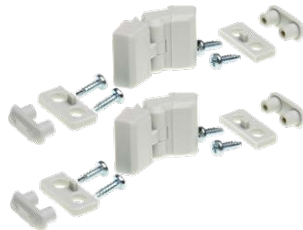

1 pair incl. fixing screws

Cover screw set

ST4.A000.01



4 cover screws und 4 fixing screws for DIN rail and mounting panel

Key-lock devices for single hole mounting 16/22 mm, IP 66/67/69k

Size S00

V750D/2.



Spare key 601

2005442 | S00.V750.S2

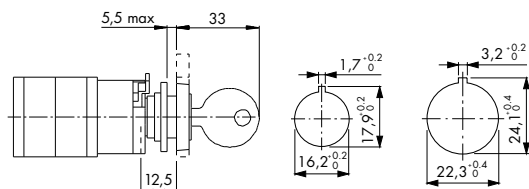

(Use for safety requirements V750D/D.)

Ordering example:

CA4.A200*FS2

V750D/2 H

2 = Standard closure 601
H = Key removable

For switch size S00

With Front ring Ø 29,5 mm	Mounting FS1
With escutcheon plate 30 x 30 mm	Mounting FS2
With escutcheon plate 30 x 39 mm	Mounting FS4

Key removable

60°			90°	180°
M	H	P	G	C
N	J	Q		D

Size S00 with premium MICROMEK-Lock

V750D/5.



Spare key MM600

2311367 | S00.V750/MM600

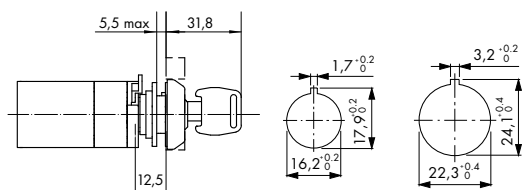

Ordering example:

CA4.A200*FS2

V750D/5 F

5 = MICROMEK-Lock, closure MM600
F = Key removable

For switch size S00

With front ring Ø 29,5 mm	Mounting FS1
With escutcheon plate 30 x 30 mm	Mounting FS2
With escutcheon plate 30 x 39 mm	Mounting FS4

Key removable

12 o'clock	9 o'clock	90°	180°
A	B	E F G R	C
			D

Size S0

V750D/3.



Spare key KN101

2006230 | S0C.V750.S2

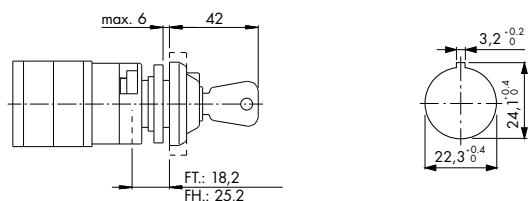

Ordering example:

CA10.A200*FT2

V750D/3 G

3 = Standard closure KN101
G = Key removable

For switch size S0

With front ring Ø 39,4 mm	Mounting FT1
With escutcheon plate 48 x 48 mm	Mounting FT2
With escutcheon plate 64 x 64 mm	Mounting FH3
With escutcheon plate 48 x 59 mm	Mounting FT6
With escutcheon plate 64 x 78,5 mm	Mounting FH4

Abziehprogramm des Schlüssels

45°	60°	90°	180°
K	H J M	G	C D
S	N P Q		T U
	X		V W



Key-lock device für base mounting VE21

Size S00

V750D/..



Spare key

3 S00.V750/MM600
2 S00.V750.S2

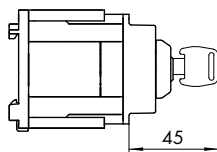

(Use for safety requirements V750D/5.)

Ordering example:

CA4.A200*VE21

V750D/5 A

5 = Premium MICROMEK-Lock, Closure MM600

2 = Standard closure 601

= Key removable (refer scheme below)

We recommend mounting *VE21-V when using CG4. This type of mounting provides vertical terminals (top and bottom) instead of standard horizontal terminals (left and right).

Possible number of stages: CA4.. = 2-5, CG4.. = 1-3

Key removable with MICROMEK-Lock

12 Uhr		9 Uhr		90°				180°	
A		B		E	F	G	R	C	
								D	

Key removable with standard lock

60°			90°		180°	
M	H	P			C	
N	J	Q	G		D	

Size S0

V750D/3.



Spare key KN101

S0C.V750.S2

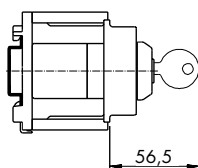

Ordering example:

CH10.A200*VE21

V750D/3 G

3 = Standard closure KN101

= Key removable

Key removable

45°		60°				90°		180°	
K		M	H	P			C		
S		N	J	Q	G		D		

Key covers

Red

S00.V750.52



For key S0C.V750.S2

S00.V750.62



For key S00.V750.S2

CONTROL SWITCHES AND LOAD SWITCHES

Key-lock device with premium Kaba 8 lock, Standard closure AS158274 (compatible with 316201), IP 40

Four hole panel mounting, (For switch size S0, shipment without mounting screws)¹

V750D/.../.

Spare key 316201
2013625 | SIC.V760.S2

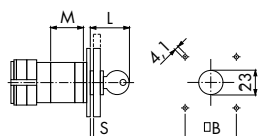

Ordering example:
CA10.A200*E
S0.V750D/ A 1 A / 1

- A = square escutcheon plate
- B = rectangular escutcheon plate
- 1 = Kaba 8 closure, cylinder 1065, for programs A to G
- 2 = Kaba 8 closure, cylinder 1262, for programs G to L
- = Key removable (refer scheme below)
- 1 = escutcheon plate 48 x 48 □, 48 x 59 □, (Mounting E)
- 11 = escutcheon plate 64 x 64 □, 64 x 79 □, (Mounting EG)

Key removable	B (E)	B (EG)	M (E)	M (EG)	S	L (E)	L (EG)
1A-1G	36	48	30,5	32,2	1-3,5	40,3	39,8
2G-2L					1-12,5	49,3	48,8

¹ Recommendation: 4 x M4 x 15 or Kit: S0D.M280.N (for S max. 3,5 mm)

Single hole mounting 25mm and front ring Ø 35mm (For switch size S0)

V750D/..1

Spare key 316201
2013625 | SIC.V760.S2

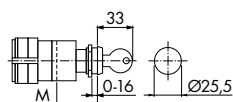

Key removable	M
1A-1G	37,2
2G-2L	47,2

Ordering example:
CA10.A200*E1
S0.V750D/ 1 A 1

- 1 = Kaba 8 closure, cylinder 1065, for programs A to G
- 2 = Kaba 8 closure, cylinder 1262, for programs G to L
- = Key removable (refer scheme below)

Base mounting, mounting VE2, (For switch size S0)

V750D/..2

Spare key 316201
2013625 | SIC.V760.S2

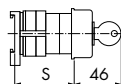

S	Max. number of stages, mounting VE2				
	CA10	CA11	CA20	CG8	CH10
50	1	-	-	-	-
61	2	1	1	1	1
67	-	2	2	-	-
69	3	2	2	-	-

Ordering example:
CA10.A200*VE2
S0.V750D/ 1 A 2

- 1 = Kaba 8 closure, cylinder 1065, for programs A to G
- 2 = Kaba 8 closure, cylinder 1262, for programs G to L
- = Key removable (refer scheme below)

Key removable at this page

12 o'clock	9 o'clock	30°	45°	60°	90°	180°
A	B	L	K	H	E F	C
				J	G	D

Optional extras



Key-lock device with Kaba 8 lock, cylinder 1007, closure AS158274 (compatible with 316201), IP 40

Single hole mounting 40mm (For switch size S1)

V750/A1



Front ring Ø 45 mm (Mounting EL1)
Escutcheon plate 64 x 64 mm (Mounting EL2)

Key can only be removed in 12 o'clock position.
 Central locking system are available.

Spare key 316201
2013625 | S1C.V760.S2

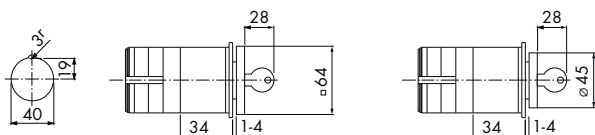

Single hole mounting 40 mm, with additional electromechanical interlock (For switch size S1)

V750/A1+V140



Escutcheon plate 64 x 64 mm (Mounting EL2)

Key can only be removed in 12 o'clock position.
 Central locking system are available.
 The interlock device is operated by energizing or de-energizing the electromechanical system.

For major features of solenoid see Chapter
ELECTROMECHANICAL INTERLOCK DEVICE

Max. ambient temperature: 35 °C for 24 hours with peaks up to 40 °C

Spare key 316201
2013625 | S1C.V760.S2

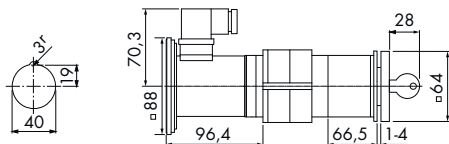

Magnet

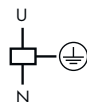

Key covers 2017

2220246 | SOD.V750.92



Red
 For Kaba 8 key.
 Other colors are available.

CONTROL SWITCHES AND LOAD SWITCHES

Key-lock device with half-cylinder lock, IP 66

Single hole mounting 22 mm (For switch size S0)

V750E/..



Spare key

A S0D.V756/BKS/6A/A2
C S1B.V760.VA2

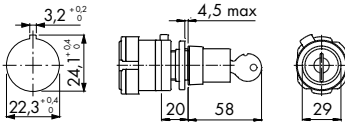

Key-lock device V750E with half-cylinder is equipped with a Single hole mounting 22 mm for switch size S0. The key can be removed in 12 o'clock position or for cam switches in every 60° switching angle position in up to six switch positions. The device with half-cylinder can be supplied with standard lock cylinders manufactured by BKS oder IKON.

Ordering example:

CA10.A200*FT

S0.V750E/ **C** **1**

A = BKS-lock, Closure S1
C = IKON-lock, Closure 360012 ¹
1 = Key removable (refer scheme below)

Key removable

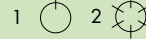

¹ Only possible with locking program 2.

Key-lock device with premium DOM-lock, IP 66, 1000 different locking numbers

Single hole mounting 22 mm (For switch size S0)

V756/D..



Spare key

K0.M999/D-0890
S0D.V765/D1/KN.../A2

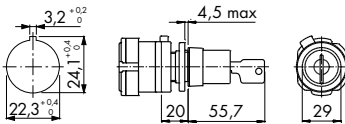

Key-lock device with half-cylinder is equipped with a Single hole mounting 22 mm for switch size S0 and could use in conjunction with switches of size S0. These must be ordered separately. The key can be removed in 12 o'clock position or for cam switches every 60° switching angle position in up to six switch positions. Closures from 0001 to 1000 available. High security against key passing.

Ordering example:

K0.M999/D-0880

S0D.V756/ **D** **1** /KN0137/A

K0.M999/D-0880

S0D.V756/ **D** **1** /KN0251/A

D = DOM-lock
1 = Key removable (refer scheme below)

Ordering example:

CG8.A722.FT

Key removable

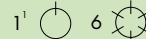

¹ 360° Turning movement

Key-lock device for enclosures, IP 40

PN1-enclosure

V750/..-PN



Spare key KN101

S0C.V750.S2

For 1-stage switches of size S0, type CA11, CA20 and 2-stage switches of size S0, type CA10-CA20

Ordering example:

CA10.A215*PN1

S0.V750/ **C** **0** -PN

S0D.T422.MA1

0 = Key removable (refer scheme below)

0 = Standard-cylinder KN101

S0D.T422.MA1 = for 2-stage switches of type CA10

S1D.T426.MA1 = for 1-stage switches of types CA11 + CA20

S1D.T427.MA1 = for 2-stage switches of types CA11 + CA20

Key removable

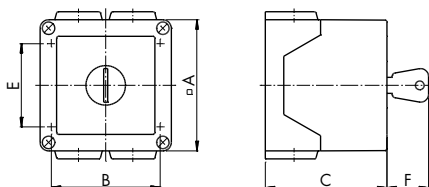
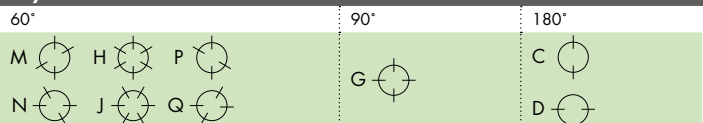

Switch-type	Number of stages	A	B	C	E	F	Conduit entries per 4x
CA10	2	64	50	68,8	36	26	M20
CA11, CA20	1 + 2	82	68	75,5	52	29	M20



Key-lock device with separate Drive, 4-hole-mounting, IP 40

With small cylinder lock (For switch sizes S0 + S1)

V760/..E

Spare key KN101
S0C.V750.S2

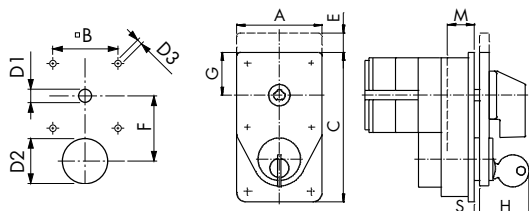

Ordering example:

CA10.A200*E

S0.V760/A 1 E 1

- A = square escutcheon plate
- B = rectangular escutcheon plate
- 1 = Key removable in locked and unlocked order
- 2 = Key just removable in locked order
- E Standard closure KN101
- 1 = Number of locking program (refer scheme below)

Size	A	B	C	E	F	G	H	D1	D2	D3	M	S
S0	48	36	82	12	40	24	31	8,5	22-23	5	9,5	1-4
S1	64	48	112	14,8	48	32	34,5	10	34	5	20,2	1-6

With commercial half-cylinder lock (For switch sizes S1 – S3)

V760/..B.
V760/..D.

Spare key
S1B.V760.ZA2 (IKON 8825100 ZN1)
S1C.V760.S2 (Kaba 316201)

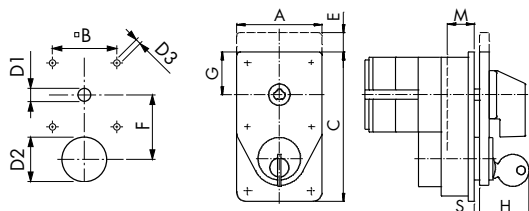

Ordering example:

CA10B.A290*E

S1.V760/A 1 B 1

- A = square escutcheon plate
- B = rectangular escutcheon plate (Size S1)
- 1 = Key removable in locked and unlocked order
- 2 = Key just removable in locked order
- B IKON-lock, closure 8825100 ZN1
- D Kaba 8 lock, cylinder 1007, closure 316201
- 1 = Number of locking program (refer scheme below)

Size	A	B	C	E	F	G	H	D1	D2	D3	M	S
S1	64	48	112	14,8	48	32	34,5	10	34	5	20,2	1-6
S2	88	68	146	-	70	44	35,5	12	34	5,4	15,5	1-5,5
S3	130	104	181,5	-	86	65	36,5	15	34	7	24	1-7

With commercial half-cylinder lock incl. a second switch (For switch sizes S1 – S3)

V760/..D.*



Second switch is mounted on lock and is operated with key.
Application On request

Number of locking program	Switching Angle	Switch Positions		Size
		to be lockable	not to be lockable	
1	30°–90°	one	the balance	S0–S3
2	20°	all	none	S0, S3
3	30°–90°	the balance	one	S1–S3
4	30°–90°	one ¹	the balance ¹	S0–S3

¹ Locking program 4 permits the locking of the device in any switch position. However, the actual locking becomes effective in a pre-determined switch position only.

CONTROL SWITCHES AND LOAD SWITCHES

Key-lock device with half-cylinder lock, total length 40,5 mm, IP42

Four hole panel mounting (For switch size S0)

For switches with two or more switch positions available.
Switch position both-sided of max. 2 x 135° possible.
Key is removable in 12 o'clock position.

V755/A1



With lock CES 851

NEW With Closure KUN1

V755/Z1



Without lock

For switches with two switch positions available.
(For switching angle 30°)
Both switch positions are lockable.
Key is removable in 12 o'clock position.

V755/A2



With lock CES 851

NEW With Closure KUN1

Switch programs to be used:

ON/OFF switch		Double-throw switch	
WAA100, F264	instead A200	WAA120, F072	instead A220
WAA101, F264	instead A201	WAA121, F072	instead A221
WAA102, F264	instead A202	WAA122, F072	instead A222
WAA103, F264	instead A203	WAA123, F072	instead A223

Other switch programs On request.

V755/Z2



Without lock

Switch programs should be used as for type V755/A2.

NEW Replacement available only as a set (Lock / 3 Keys KUN1)
2324855 | S0D.V755/CESNP/KUN1

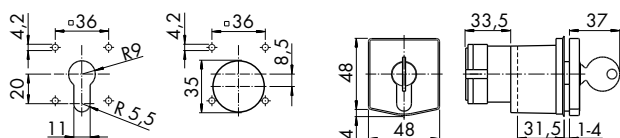

Versions optionally available

Notice:

Suitable drilled enclosures see at chapter **MOUNTING**.

Optional extras



Key-lock device with separate drive for half-cylinder lock, total length 40,5 mm, IP42

(For switch size S0)

V765/.H



With lock CES 851

NEW With Closure KUN1

V765/.Z



Without lock

V765/.../.2



With lock CES 851

With optional dust cap, IP43

NEW With Closure KUN1

NEW

Replacement available only as a set (Lock / 3 KUN1)
2324855 | SOD.V755/CESNP/KUN1

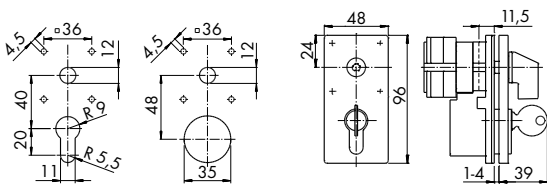

Types optional

Ordering example:

CA10 A200*E

S0 V765 / A H 1

A = Key removable in locked and unlocked order

B = Key just removable in locked order

H = with lock CES 851, Closure KUN1

Z = without lock

1 = Number of locking program (refer scheme below)

Number of locking program	Switching Angle	Switch Positions	
		to be lockable	not to be lockable
1	30°-90° 20°	one	the balance
2	30°-90°	all	none
4	30°-90°	one ¹	the balance ¹

¹ Locking program 4 permits the locking of the device in any switch position. However, the actual locking becomes effective in a pre-determined switch position only.

Front built-in lights, IP 40

Single hole mounting, lamp with 120 mm stranded wires (Size S0 and S1)

Square escutcheon plate assembled ex works

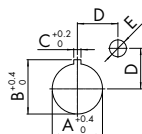

Bau- größe:	A	B	C	D	E
S0	22,3 ^{+0,2}	24,1 ^{+0,2}	3,2 ^{+0,2}	18	7,5
S1	22,3 ^{+0,2}	24,1 ^{+0,2}	3,2 ^{+0,2}	24	7,5

Ordering example Size S0 (48 x 48)

CH10.A215.FT2 F000 Push-button, 1-pole spring return latching mechanism of both sides, Single hole mounting

S0 F025/A10/B-E1L Escutcheon plate with recesses top right
Escutcheon plate lettering 1-0-2 (see page 142)

SOC.T700.52 Lamp (refer scheme below)

Ordering example Size S1 (64 x 64)

CH10.A215.FH3 F000 Push-button, 1-pole spring return latching mechanism of both sides, Single hole mounting

S1 F025/A10/B-E1L Escutcheon plate with recesses top right
Escutcheon plate lettering 1-0-2 (see page 142)

SOC.T700.52 Lamp (refer scheme below)

Rectangular escutcheon plate assembled ex works

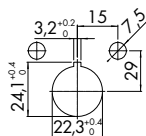
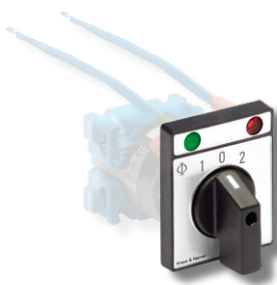

Ordering example Size S0 (48 x 59)

CH10.A214.FT6 F000 Push-button, 1-pole spring return latching mechanism of both sides, Single hole mounting

S0 F025/A10-E1L Escutcheon plate without recesses
Escutcheon plate lettering 1-0-2 (see page 142)

S0.F991/A00/B2-P2B Ungraved rectangular Face plate with two recesses

SOC.T700.52 Lamp (refer scheme below)

Notice:

Dimensions S1 on request

PN-enclosure 64 mm assembled ex works Lamp with 120 mm stranded wires



Ordering example:

CA10.A202.PN1 Complete switch, ON/OFF switch 3-pole, Plastic enclosure

S0.T999/425 Hole for lamp

SOC.T700.52 Lamp (refer scheme below)

Notice:

Larger enclosures (only for red lamp 230 V) on request

Part number lights



Order number lamp	Colour	Voltage
SOC.T700.52	red-transparent	230 V
SOC.T700.53	red-transparent	24 V
SOC.T700.55	green-transparent	24 V
SOC.T700.57	yellow-transparent	230 V
SOC.T700.59	clear	230 V

Notice:

Other colours and voltage on request.

Trip indicator, IP 40

M120/A
M120/B



With square escutcheon plate (64 x 64)

With rectangular escutcheon plate (48 x 59 and 64 x 78)

The trip indicator used on switches with spring return positions. It includes a colored indicator to show the last spring return position that handle has been turned.

Two possibilities for flag indicator exist:

- left red – right green
- left green – right red

Ordering data: The color to appear after left or right operation.

Control and indicator device, single lamp, BA9s socket, IP 42

(Max. power 2 W, Switch size 50)

Q120/A
Q120/F

Ordering data: Front end assembly and function of the mechanical interlock, quantity and operation of the Auxiliary contacts and type of the contact system.

Turn to operate

Push-to-turn operation (e.g. control and alarm switch)

The control and indicator device Offers a total switching angle of 360°, Single hole mounting 22/30 mm with lock nut and mounting/demounting without using tools.

The following front end assemblies are available:

- Front ring
- Escutcheon plate 48 x 48 mm
- Escutcheon plate 64 x 64 mm

The push-to-turn version is available with 1 oder 2 Auxiliary contacts and a mechanical interlock. Optionally select between a contact system with rigid contact bridge for excellent AC-15 making and breaking capabilities, also available with gold contacts for use in aggressive (harsch) environments. Or select an H-bridge design with „cross-wire“ gold-plated contact system for low voltage and low current.

NOTICE:

Shipment without bulbs.



Front ring



Escutcheon plate

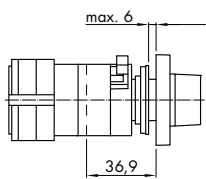

Q 120 Turn to operate

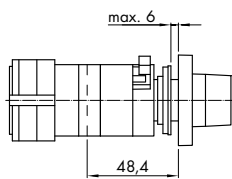

Q 120/F Push-to-turn operation (without auxiliary contacts)

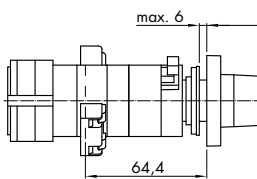

Q 120/F Push-to-turn operation (with auxiliary contacts)

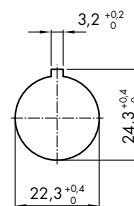

LED-lamps with 4 chips and integrated bridge rectifier, BA 9s socket



Color	Voltage	Order number
White	24 V–28 V AC/DC	P.SN/LW024
Red	24 V–28 V AC/DC	P.SN/LR024
Green	24 V–28 V AC/DC	P.SN/LG024
White	110-120 V AC/DC	P.SN/LW110
Red	110-120 V AC/DC	P.SN/LR110
Green	110-120 V AC/DC	P.SN/LG110
White	220 V AC/DC	P.SN/LW220
Red	220 V AC/DC	P.SN/LR220
Green	220 V AC/DC	P.SN/LG220

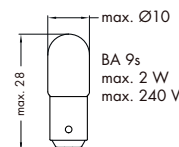

Control and indicator device, with LED module and Light Conductor, IP 40

(Switch size 500)

Ordering data: Operating voltage and type of version.

Q100B

The luminous source is a LED module with yellow lightemitting diode mounted at the end of the switch. Light transmission via light conductor.



Single hole mounting



Mosaic mounting

Single hole mounting (Type of version with interlock only for 22,3 mm possible)

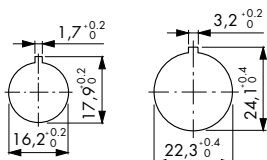

Voltage	Frequency	Power Consumption
24 V	AC 50–60 Hz, DC	0,2 W
48–60 V	AC 50–60 Hz	0,3 W
48–60 V	DC	1 W
110–120 V	AC 50–60 Hz	0,3 W
110–120 V	DC	1,4 W
220–240 V	AC 50–60 Hz	0,3 W
With test terminal		
24 V	DC	0,2 W
48–60 V	DC	1 W
110–125 V	DC	1,4 W

Available variations:

Without interlock (handle „turn to operate“ – with interlock (handle „push-to-turn operation – push handle and turn, max switching angle 150 °, 8:00 – 1:00 o'clock.). The control and indicator device is available for single hole and mosaic mounting.

	A	C	D	F	M	Single hole mounting Mounting Ø M	Mosaic mounting
Without interlock	30	5	29,5	39	17,7	16/22	29
With interlock	30	6,5	29,5	39	19,5	22	33

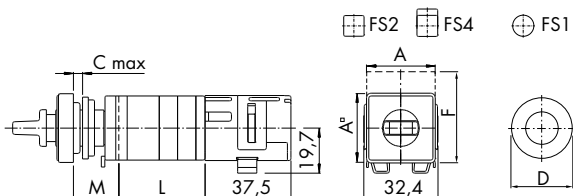

Mosaic mounting

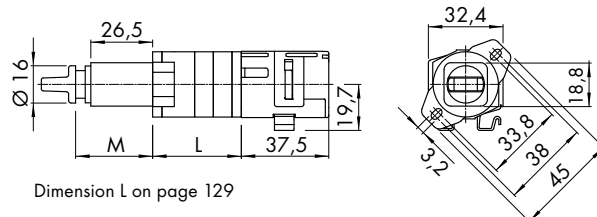

Dimension L on page 129

Stop and go devices

Ordering data: Operation of the stop and go device.

V160



The stop and go device prevents a fast switching thru the center OFF position, only possible at a 60° switching angle. The stop and go device only becomes activated in the center switch position, either in both or just in single direction. (Size S0)

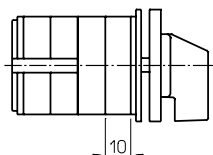

Interlock between switches

Ordering data: Specify interlocking modus

V600/B
V600/C



For 2 switch columns (Size S1–S3)
For 3 switch columns (Size S1–S3)

An interlock between 2 oder 3 switch columns permits the operation of one switch only when the other switch or switches are located in a pre-determined switching position. For heavy duty service reinforced devices are available.

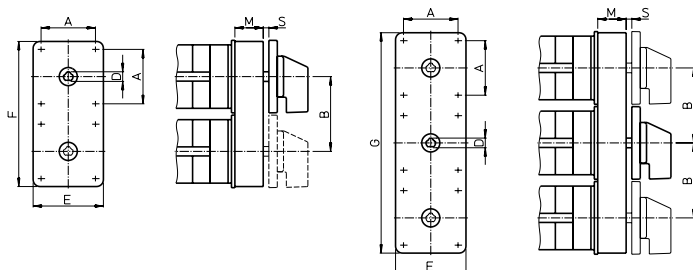

V600/B

V600/C

Size	A	B	D	D3	E	F	G	M	S
S1	48	66	8,5	5	62	128	194	23,2	1,4–4,5
S2	68	93	11,2	6	92	183	276	30	1,5–7
S3	88	144	14	7	130	274	418	24	1,5–8,3

Auxiliary contacts

Ordering data: Quantity, operation of the auxiliary contacts and type of contact system.

M510B

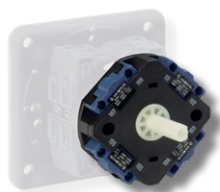

Cam controlled (Size S1 (except CA10B ff.), S2, S3)

These particular type of auxiliary are controlled by a programmable cam. The max. number of Auxiliary contacts for switches of size S1 and S2 is 4 contacts and for switches of size S3 is 6 contacts.

Select between a contact system with a rigid bridge for excellent AC-15 making and breaking capabilities or an H-bridge design with „cross-wire“ contacts (sizes S1 and S2) for low voltage low current. A second contact system with gold or gold plated contacts is available suitable for use in an aggressive (harsh) environment. .

In cases where more than 4 resp. 6 Auxiliary contacts are required, an auxiliary switch should be used alternatively.

Front panel mounting

Base mounting

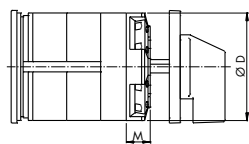
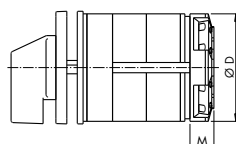

Front panel mounting (Mounting E)		
Size	M	D
S1	16	64
S2	18,7	84
S3	17	128

Base mounting (Mounting VE)		
Size	M	D
S1	11,5	64
S2	11,7	84
S3	8	128



Push-pull interlock

Ordering data: Description of the interlocking program, number and operation of the auxiliary contacts.

V110A
V115A
V130A
V135A

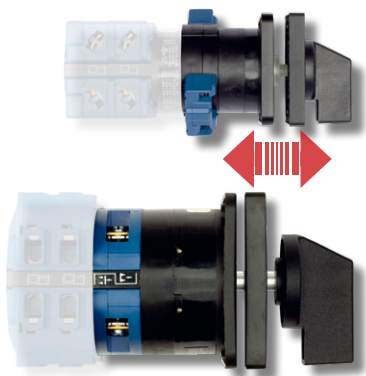

V110
V115
V120
V130
V135

- To pull lateral spring return (Size S0)
- To pull lateral latching (Size S0)
- To push lateral spring return (Size S0)
- To push lateral latching (Size S0)

- To pull lateral spring return (Size S1–S3)
- To pull lateral latching (Size S1)
- To pull an to push lateral spring return (Size S1–S3)
- To push lateral spring return (Size S1–S3)
- To push lateral latching (Size S1)

The push-pull device is used to interlock the switch so that the handle can be rotated only when pushed oder pulled. Therefore the can be self-locking or automatically be pulled back axially. The push-pull device can be programmed to allow the interlock to operate only between pre-determined switch positions. Auxiliary contacts can be operated by means of the axial movement of the handle. For switches size S0 the max. number of Auxiliary contacts is 2 contacts, for all other sizes 8 contacts. In addition switches size S0 can also be combined with a trip indicator.

Notice:

For heavy duty service we recommend the alternative use of DK10 series. See chapter „Switches for special use and DC switches“

V110A–V135A, Four hole mounting (Size S0)

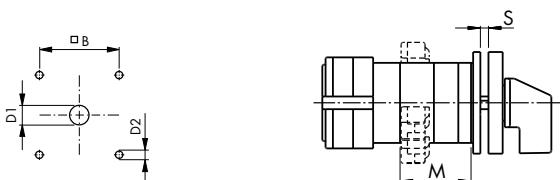

V110A–V135A, Single hole mounting (Size S0)

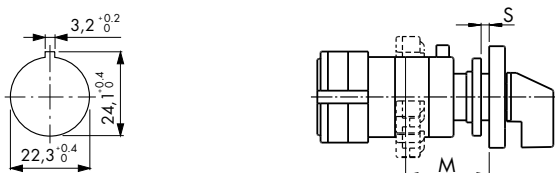

V110, V115, V130, V135, Four hole mounting (Size S1)

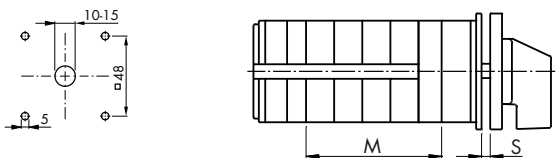

V120, Four hole mounting (Size S1)
V110, V120, V130, Four hole mounting (Size S2 + S3)

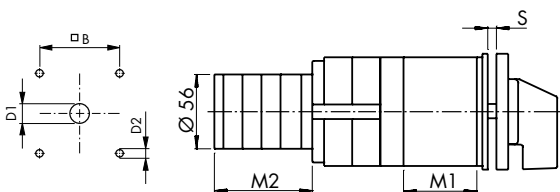

M=Additional length for Push-pull interlock and auxiliary contacts

	Mounting							
	E		EG		FT2		FH3	
	V110A V130A	V115A V135A	V110A V130A	V115A V135A	V110A V130A	V115A V135A	V110A V130A	V115A V135A
M (without auxiliary contact)	17,5	33,5	24,5	40,5	24	40	31	47
M (with auxiliary contact)	33,5	33,5	40,5	40,5	40	40	47	47
S	1–2	1–2	1–2	1–2	1–6	1–6	1–6	1–6
B	36	36	48	48				
D1	8–15	8–15	10–15	10–15				
D2	5	5	5	5				
Size of escutcheon plate:	48 x 48	48 x 48	64 x 64	64 x 64	48 x 48	48 x 48	64 x 64	64 x 64

M=Additional length for Push-pull interlock and auxiliary contacts

Size	Number of auxiliary contacts				
	0–2	3–4	5–6	7–8	S
S1 ¹	M	M	M	M	S
S1	39,9	57,4	74,9	92,4	0–4
S1	29,5	47	64,5	82	0–4

¹ For Switch type CA..B, CH..B, CG..B

M1 =Additional length for Push-pull interlock
M2 =Additional length for auxiliary contacts

Size	Number of auxiliary contacts				
	0	1 + 2	3 + 4	5 + 6	7 + 8
S1 ¹	M1	M1 + M2	M1 + M2	M1 + M2	M1 + M2
S2	51,7	101,4	120,4	139,4	158,4
S3	69	127,6	146,6	165,6	184,6
S3	85	151,6	170,5	189,5	208,5

¹ Only V120

Size	B	D1	D2
S1	48	10–15	5
S2	68	13–17	6
S3	104	15,5–20	7

Push button interlock

Ordering data: Number and operation of the auxiliary contacts.

V400/A1

V400/B1



Square escutcheon plate
Switching only possible if push button is pressed. (Size S1–S3)

Rectangular escutcheon plate
Switching only possible if push button is pressed. (Size S1)

Up to 4 auxiliary contacts can be operated by pressing the push button.
No Auxiliary contacts possible for Switch type CA40–CA63.

S1

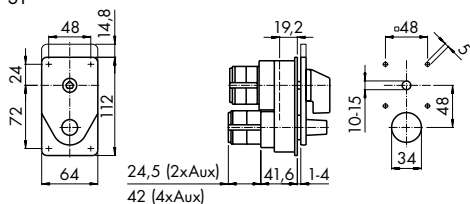

S2

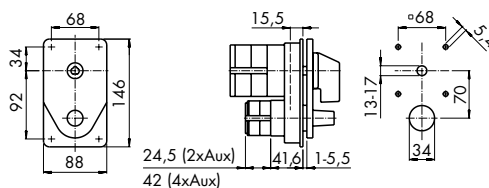

S3

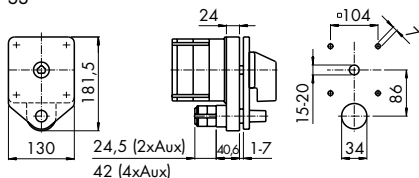

Bayonet/Switch coupling

M270
M275



For switches of the same size (Size S1–S3)
For switches of different size (Size S0–S3)

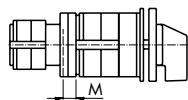

M270

Size front switch	Coupled switch		
	S1	S2	S3
S0	-	-	-
S1	8,8	-	-
S2	-	12,9	-
S3	-	-	32,9

M275

Size front switch	Coupled switch			
	S00	S0	S1	S2
S0	0,0	3,7	-	-
S1	1,3	1	-	-
S2	10,2	2,6	1,9	-
S3	12,7	10,4	10,4	11,4



Electromechanical interlock

Ordering data: Advise if the interlock is activated either by energizing or de-energizing of the electrical system. Coil voltage also required.

V140

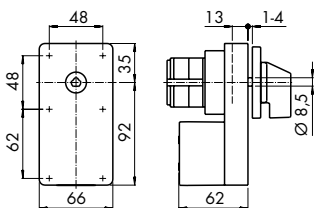

Integrated AC solenoid (Switch size S1)

The switch can be locked in any position by an electromechanical interlock. The interlock device is operated by energizing or de-energizing the electromechanical system. Adding Auxiliary contacts to the switch permits the device to be operated only in pre-determined positions.

Ambient temperature: 35 °C during 24 hours with peaks up to 40 °C
(Switch program CA40 on request)

Major features	
Frequency	50 Hz, 60 Hz, 50/60 Hz
Possible voltage	24 V–600 V
Pull-in power	55 VA/50 Hz oder 70 VA/60 Hz
Holding power	11 W

V140

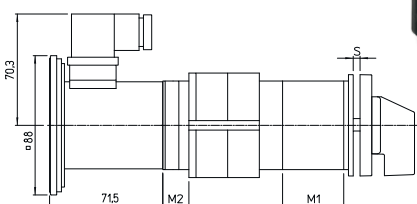

Solenoid with integrated rectifier (Switch size S1 (except CA10B ff.), S2, S3)

The switch can be locked in any position by an electromechanical interlock. The interlock device is operated by energizing or de-energizing the electromechanical system. Adding Auxiliary contacts to the switch permits the device to be operated only in pre-determined positions.

Ambient temperature: 35 °C during 24 hours with peaks up to 40 °C

Notice: Solenoid not UL approved

Major features	
Dual frequency	50/60 Hz and DC
Possible voltage	24 V, 48V, 60 V, 110 V, 125 V, 230 V and 240 V
Completely encapsulated coil, temperature at the surface of 80-85°C at an ambient temperature of 25°C	
Magnetic force	12 N, Hub 7 mm, on-time 100 %
Weight of solenoid ca.	1 kg
IP-code solenoid	IP65
Max. terminal cross-section	3 x 1,5 mm ²
Max. current	1,5 A
Pull-in and holding power	20 W

Baugröße	M 1 + M 2	S
S1	56	0-4
S2	102	0-5,5
S3	111,1	0-7

M1 = Additional length for interlocks
M2 = Additional length for support plate

S1E.V140.K

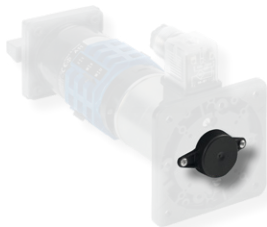

Armature cover

For increased safety requirements.
Additional length: 10 mm

Tandem drive

M300/B M300/C



For 2 switch columns (Switch size S1–S3)

For 2 switch columns (Switch size S1–S3)

Two or three switch columns can be operated simultaneously. Special programs are available to reinforce the device for heavy duty applications.

(Switch programs for CA40–CA63 and A-switches On request)

M300/B

M300/C

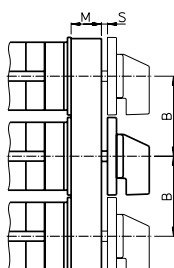
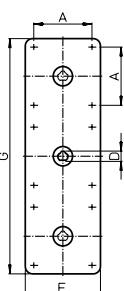
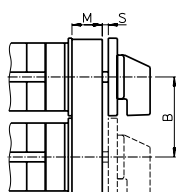
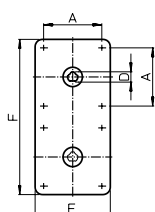

Size	A	B	D	E	F	G	M	S
S1	48	66	8,5	62	128	194	23,2	1,4–4,5
S2	68	93	11,2	92	183	276	30	1,5–7
S3	88	144	14	130	274	418	24	1,5–8,3

Electromechanical trip device (Shunt-trip)

Ordering data:
Operating voltage for the magnetic system.

V360/A



Size S1

The device remote trigger function into trip position. The coil is designed for short-time duty requiring an auxiliary contact in the switch which de-energizes the coil in the trip position.

Controlling of the magnetic system:
24 V to 440 V/50 Hz, 60 Hz or DC

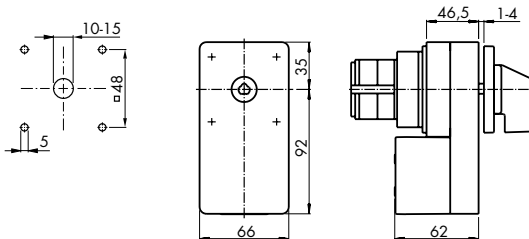

Lockout-relay

Ordering data: Operating voltage and frequency for the magnetic system

Suffix code *M* e. g. CA40M

V340/A



Provides manual release for enabling switching counterclockwise for test purposes.

(Switch programs on request, CA40–CA63 with additional stage)

The lockout-relay is typically used to remotely switch OFF or switch over electrical circuits.

The device contains a totally incapsulated coil and linear spring return mechanism which is compressed by manually turning the handle to the ON position (60°, clockwise to the OFF position). Once in the ON position, the handle is mechanically locked in place and cannot be manually turned back to OFF. Switching counterclockwise is only possible by impulse activating the unlocking device.

Gating Signal:
24 V to 440 V/50 Hz, 60 Hz or DC

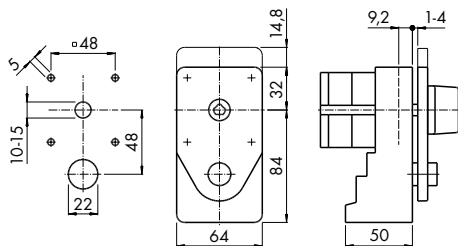

Suffix code *L* e. g. CA40L

V340/B



Without manual release

(Switch programs On request, CA40–CA63 with additional stage)

The lockout-relay is typically used to remotely switch OFF or switch over electrical circuits.

The device contains a totally incapsulated coil and linear spring return mechanism which is compressed by manually turning the handle to the ON position (60°, clockwise to the OFF position). Once in the ON position, the handle is mechanically locked in place and cannot be manually turned back to OFF. Switching counterclockwise is only possible by impulse activating the unlocking device.

Gating Signal:
24 V bis 440 V/50 Hz, 60 Hz oder DC

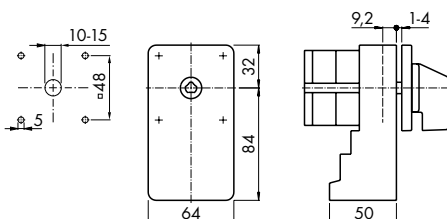

Disconnecter acc. to EN 60947 with under-voltage release without trip free release

3 pole, Four hole panel mounting, IP40



Coil voltage
230 V

400 V

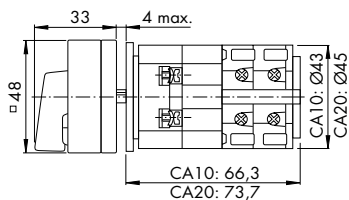
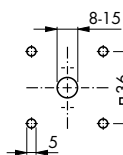
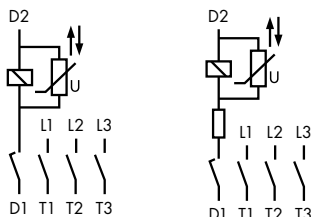

The magnetic system includes a low-noise DC voltage coil with embedded diodes (reverse voltage 1000 V). Therefore it operates frequency-independent. Switches are available with coils for 24 V up to 600 V (IP 20 to 240 V).

The magnetic system of the under-voltage release is shifting back the switch via a linear retracting into the OFF-position („0“) in case of a voltage drop below 70% of the nominal voltage. The magnetic coil is triggered by a first make contact. As the device does not contain a free-release, the main contacts close even in the Released-stage as long as the handle is manually held or blocked in the On-position („I“).

Ambient temperature: 35 °C over 24 hours with peaks up to 40 °C

Continuous current (I _v /I _{th})	Switching power AC-23B (A) 3 x 400 V	Escutcheon plate	Order number
Coil voltage 230 V, 50 Hz/60 Hz/DC			
20 A	7,5 kW	48 x 48	CA10X.T203/01.E
25 A	11 kW	48 x 48	CA20X.T203/01.E
Coil voltage 400 V, 50 Hz/60 Hz/DC¹			
20 A	7,5 kW	48 x 48	CA10X.T203/D-A004.E
25 A	11 kW	48 x 48	CA20X.T203/D-A001.E

Continuous current (I _v /I _{th})	Switching power AC-23B (A) 3 x 400 V	Escutcheon plate	Order number
Coil voltage 230 V, 50 Hz/60 Hz/DC			
20 A	7,5 kW	48 x 48	CA10X.T103/01.E
25 A	11 kW	48 x 48	CA20X.T103/01.E
Coil voltage 400 V, 50 Hz/60 Hz/DC¹			
20 A	7,5 kW	48 x 48	CA10X.T103/D-A001.E
25 A	11 kW	48 x 48	CA20X.T103/D-A004.E

¹ Auxiliary terminal for series resistor not finger proof

Main-/Emergency switches with under-voltage release acc. to EN 60204, with trip free release

3 or 4 pole, Four hole panel mounting, IP40



3 pole

4 pole

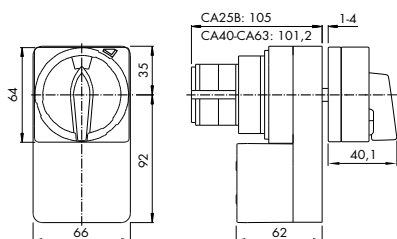
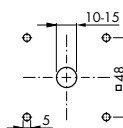
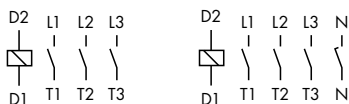

The magnetic system of the under-voltage release is shifting the switch into the release position („+“) in case of a voltage drop below 70% of the nominal voltage. This is as well the delivery status.

By turning the grip back from the released-position „+“ into the On-position („I“) the release spring is loaded and remains loaded when switching between On- („I“) and OFF-position („0“). As the device includes a free-release acc. To EN 60947-1, the main contactors remain open in the released-stage even the handle is manually held or blocked in the On position („I“)

Ambient temperature: 35 °C over 24 hours with peaks up to 40 °C

Continuous current (I _v /I _{th})	Switching power AC-23B (A) 3 x 400 V	Escutcheon plate	Order number	
			3 pole	4 pole
Coil voltage 230 V, 50 Hz				
32 A	15 kW	64 x 64	CA25B.T203/92.E	CA25B.T204/92.E
40 A	18,5 kW	64 x 64	CA40.T203/82.E	CA40.T204/82.E
50 A	22 kW	64 x 64	CA50.T203/82.E	CA50.T204/82.E
63 A	30 kW	64 x 64	CA63.T203/82.E	CA63.T204/82.E
Coil voltage 400 V, 50 Hz				
32 A	15 kW	64 x 64	CA25B.T203/D-A026.E	CA25B.T204/D-A011.E
40 A	18,5 kW	64 x 64	CA40.T203/D-A002.E	CA40.T204/D-A001.E
50 A	22 kW	64 x 64	CA50.T203/D-A001.E	CA50.T204/D-A001.E
63 A	30 kW	64 x 64	CA63.T203/D-A001.E	CA63.T204/D-A003.E

Continuous current (I _v /I _{th})	Switching power AC-23B (A) 3 x 400 V	Escutcheon plate	Order number	
			3 pole	4 pole
Coil voltage 230 V, 50 Hz				
32 A	15 kW	64 x 64	CA25B.T103/92.E	CA25B.T104/92.E
40 A	18,5 kW	64 x 64	CA40.T103/82.E	CA40.T104/82.E
50 A	22 kW	64 x 64	CA50.T103/82.E	CA50.T104/82.E
63 A	30 kW	64 x 64	CA63.T103/82.E	CA63.T104/82.E
Coil voltage 400 V, 50 Hz				
32 A	15 kW	64 x 64	CA25B.T103/D-A004.E	CA25B.T104/D-A002.E
40 A	18,5 kW	64 x 64	CA40.T103/D-A002.E	CA40.T104/D-A001.E
50 A	22 kW	64 x 64	CA50.T103/D-A001.E	CA50.T104/D-A001.E
63 A	30 kW	64 x 64	CA63.T103/D-A001.E	CA63.T104/D-A001.E

60 Hz respectively other coil voltages Upon request (With DC a series resistor is required).

CONTROL SWITCHES AND LOAD SWITCHES

Spring return latching mechanism

Ordering data: Specify spring return from either left or right side for M470.

M470 / A
M470

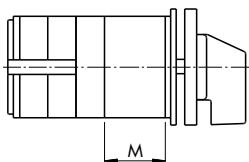

Spring return from both ends (Size S0–S2)
Spring from one end (Size S0 + S1)

The spring return up to 30° switching angle is operated through the latching mechanism. In case of very many contacts being lifted simultaneously or if the total receding angle is more than 30°, the switch is equipped with a spring return latching mechanism. The spring return from both ends can be designed latching positions to one side are feasible. (S1.M470 Mounting EF IP66/67)

Size	M (M470/A)	M (M470)	Shaft hole
S0	33,3	33,3	8–15
S0 (Switches of next larger size e.g. CH10B)	40,3	29,2	18,5
S1	33,3	22,2	18,5
S2	75		13–17

Uni-directional interlock

Ordering data:
Specify interlock position

M400



(Size S0–S2 with 360° rotation)

The uni-directional interlock prevents the switch from being operated counterclockwise. The interlock can be designed either in all switch positions or in one particular position.

Slip and ratchet clutch

M200



Slip clutch (Size S0 + S1)

The slip clutch allows to link two camshafts together, one master and one slave camshaft. The here slave camshaft is activated not until the master camshaft reaches a defined turning angle. This clutch i.e. enables the de-energized downshift of switches for pole-switchable motors. Not available for DH-Switches. The additional length is one cam.

Motor drive

R300

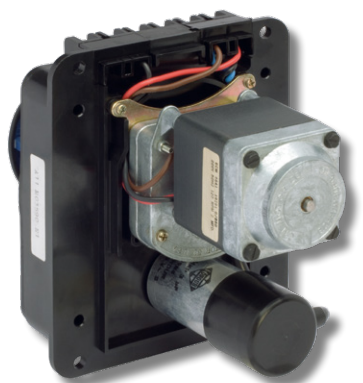

(Size S1 – S3)

The motor drive consists of an AC motor R300 with capacitor, transmission and maltese drive. With this, switches can be operated step by step. The motor can be delivered for operating voltages of 230V, 50Hz or 220V, 60 Hz. Please see separate Datasheet for Drivers.

Ambient temperature: 35 °C over 24 hours with peaks up to 40 °C

Horizontal motor axle

Notice: Motor Drive not UL certified

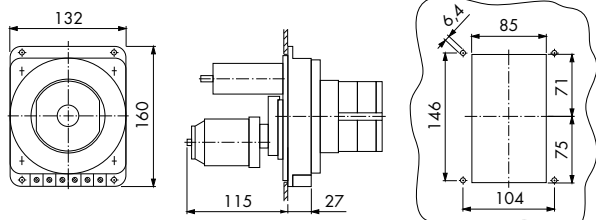

Optional extras



Terminal cover

M160



The protective cover prevents accidental contact with energized terminals. (C80, C125, C315, C316, L400)

Protectiv earth and neutral terminals

SOD.H040/E
SOD.H040/N
SOD.H040/NE

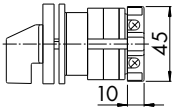

PE terminal (Size S0)
Neutral terminal (Size S0)
PE and neutral terminal (Size S0)

S00.H040.S
SOD.H040.S



PE terminal (Size S00)
PE terminal (Size S0)

Special drives

G800/B

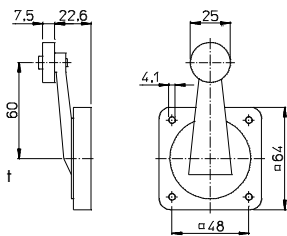

Heavy duty drive unit with actuator and roller (Size S1)

G800/C

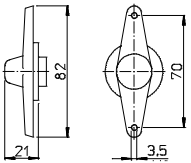

Double action lever (Size S1)

G900/B

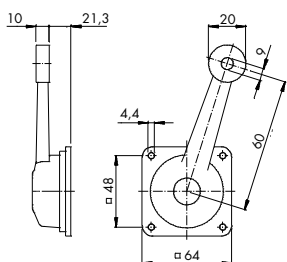

Rope operation available for spring return, maintained or stepping operation. (Size S1)

Standard door clutch for enclosures

Door clutch with four hole mounting shaft fixation with set screw

M280E/.-EF

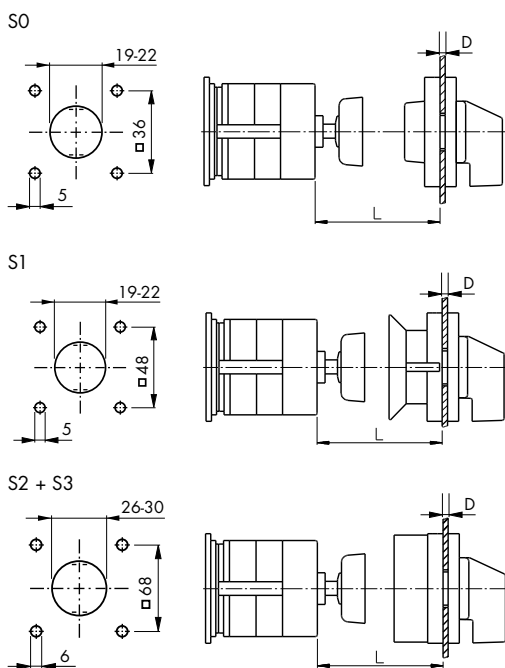
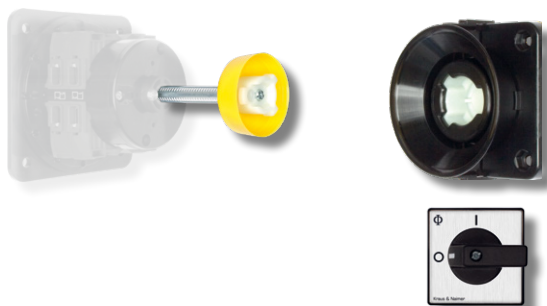

Ordering data:

Total installation depth of switch incl. door clutch.

With shaft extension, IP 66/67 front

Door clutches of size S1 can be combined with switches of size S0.

		Type	
M280E/A	2	I	S-EF
A	= without interlocking		
B	= with interlocking, standard possible at 9 h or every 90°		
	= Dimension L refer scheme below		

Size	D	1	2	3	4	Z
S0	4,0	36-55	56-75	76-95	96-116	100
S1	4,0	32-57	58-77	78-97	98-118	100
S2	5,5	60-90	90-120	120-150	150-180	110
S3	7,0	60-95	95-130	130-165	165-200	110

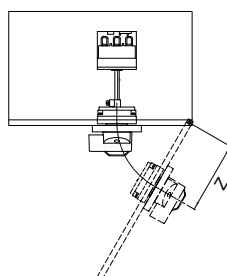

Optional extras

Door clutch with single hole mounting 22 mm, IP 66, without padlock device (Switch size S0+S1) shaft fixation with set screw

M295/.A

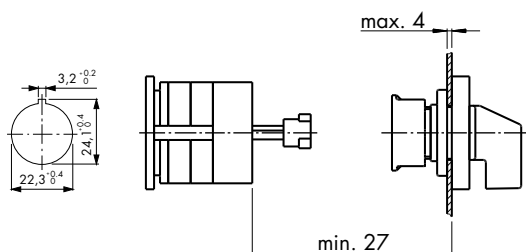
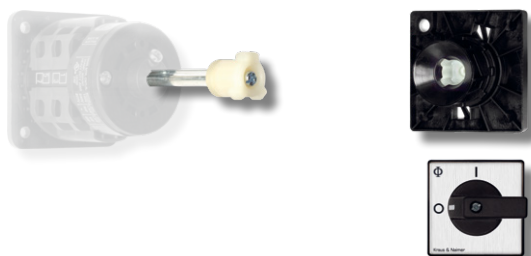

Ordering data:

Total installation depth of switch incl. door clutch.

In addition, a shaft extension is required.

		Type		
S0.M295/A	A	I	/I1	
		Escutcheon plate	Escutcheon plate frame	handle
A	= Alu	black	black	black
B	= Alu	black	black	red
C	= black	black	black	black
D	= black	black	black	red
E	= yellow	black	black	red
1	= without interlocking			
2	= with interlocking, unlocked at 9 h			
3	= with interlocking, unlocked at 12 h			



Door clutch for switch cabinets with padlock device

Main switch application upon request

Four hole mounting with padlock device, IP 66

M700/

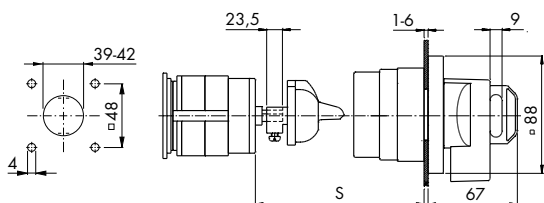

Handle lockable with padlocks (Switch size S0-S3)

Door lock in On-position („I“) and with applied Padlock device as well in OFF-position („0“). The door of the switch cabinet can under normal conditions only be opened in OFF-position („0“) of the switch. With the attached special tool the locking mechanism can be released in the OFF-position („0“). A maximum of 4 padlocks with a 5 mm diameter or 3 padlocks with a 8 mm diameter can be applied. The door clutch can level an +/- 5mm Offset between door clutch and shaft.

Additional shaft extension is required.

Ordering data:
Total installation depth of switch incl. door clutch.

Coloring	Escutcheon plate	handle	Lock bar
M700/A			
A	= brushed Alu	black	red
B	= brushed Alu	red	yellow
C	= brushed black	black	red
D	= brushed black	red	yellow
E	= yellow	red	yellow

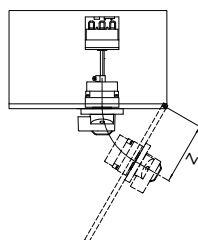

Size	Using of shaft	S min	Z
S0	S0.L100/...A	64,5	100
S1	S1.M004D	67	100
S2	S2.M004D	74,5	100
S3	S3.M004D	78	100

Door clutch for switch cabinets with standard handle

Four hole mounting with standard escutcheon plate and handle, IP 66

M701

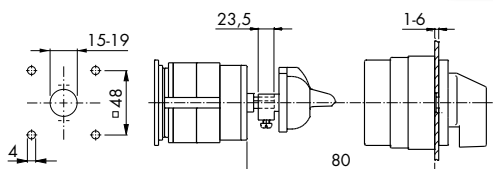

Door clutch unlocked in OFF-position („0“) (Switch size S0-S2)

In addition, a shaft extension is required.

Unlock insert for door clutch M700 + M701

S1D.M700.29



To open the door in ON-position („I“). (After door clutch has been removed, effective precautions must be taken to prevent unauthorized persons from opening the switch cabinet.)

Padlock devices

Main switch application upon request

Base mounting 45 mm standard knock-out

V840B

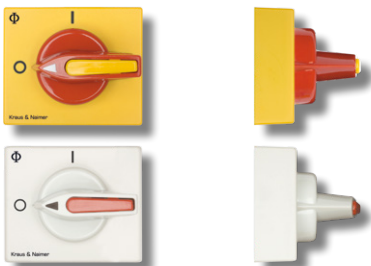

Padlock is an integrated part of the switch handle and can hold 1 padlock (Mounting VE2 and VE21)

Locking bar accessible from the front.
Available colors (handle/cover disc) black/grey, grey/grey, red/grey und red/yellow. Bail diameter max. 2 x 4,5–6 mm

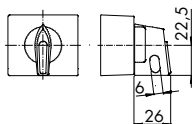

Sealable

V840A

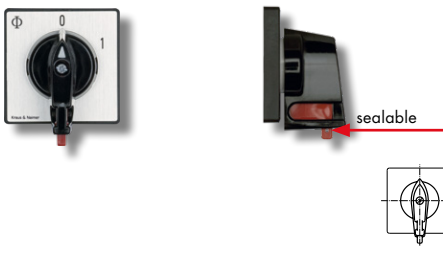

Padlock is an integrated part of the switch handle and can hold 2 padlocks and sealing

Handle available in colors black, red and electro- grey.
Cover discs available in colors yellow and brushed alu.
Upon request, the device can be programmed to lock in several switch positions (every 60° or 90°).



Baugröße	B	C	R	D in mm ^{1,2}	D in mm ³
S0 (V840A/A, .../B, .../E)	31,5	5	32,9	3,5–4,5	
S0 (V840A/C, .../D, .../F)	31,5	5	32,9	3,0–4,0	
S1	40	7	41,6	4,0–6,0	–

¹ Front panel mounting + Cast enclosure | ² Plastic enclosures + Mounting VE2 and VE21 | ³ Single hole mounting

Push button top

V850/A



For 2 padlocks (Switch size S0 + S1)

For 3 padlocks (Switch size S1 + S2)

For 6 padlocks (Switch size S2 + S3)

Upon request, the device can be programmed to lock in several switch positions (every 30°).

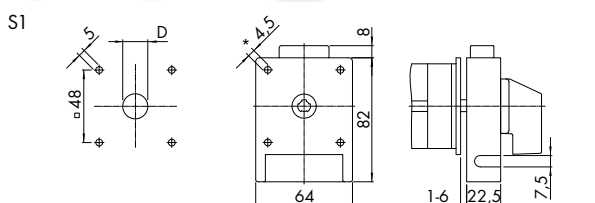

Maximum number of padlocks	D
Bail-Ø	Number of padlocks
3–5,5	2

Maximum number of padlocks	D
Bail-Ø	Number of padlocks
4–7,5	3

For 2 padlocks	D
S1.V850/1	10-15
S1.V850/11	8-15
S1.V850/12	10-15
S1.V850/13	19-22

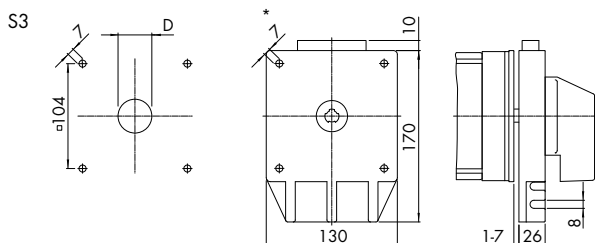

Maximum number of padlocks	D
Bail-Ø	Number of padlocks
4–7,5	6

For 3 padlocks	D
S2.V850/1	26-30
S2.V850/11	10-15
S2.V850/12	26-30
S2.V850/13	26-30

For 6 padlocks	D
S3.V850/1	15,5-20
S3.V850/11	26-30
S3.V850/12	15,5-20
S3.V850/13	22-25

Switch-side

K3B.V840VE

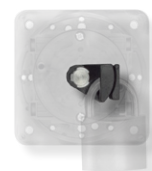

To mount a padlock when the switch cabinet is open (Size S2)

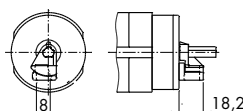

Padlock devices

Main switch application Upon request

T-handle

V845

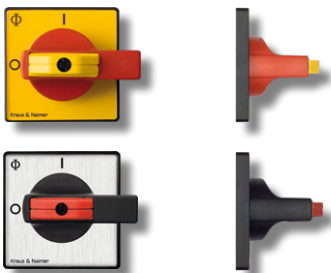

For 4 padlocks (Locking bar accessible from the front.)

Handle is available in black or red, escutcheon plate in yellow and brushed Alu. Upon request, the device can be programmed to lock in several switch positions.

Size	A	R	Q
S0	48	51	7,2
S1	64	58	8,1
S2	88	73	9
S3	130	86,5	9

Maximum number of padlocks		
Escutcheon plate	Bail- \varnothing	Number of padlocks
48 x 48	7	2
	3	4
64 x 64	7,5	3
	4	4
88 x 88	4-8	2-4
130 x 130	4-8,5	2-4

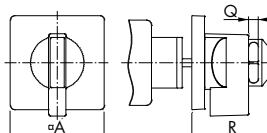

F-handle

V840D

V840G
V840F/F



For 2 padlocks Size S0 (48 x 48)

For 3 padlocks Size S2 (88 x 88)

For 3 padlocks Size S1 (64 x 64)

For 4 padlocks Size S1 (64 x 64)

Padlock device with integrated F-handle. Handles are available in black, red and electro-grey, cover discs in black, yellow and electro-grey.

V840D Size S0 (48 x 48)

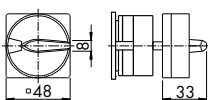

V840D Size S2 (88 x 88)

V840G, V840F/F

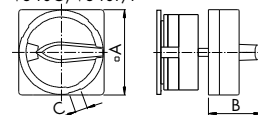

	A	B	C
V840D	88	49,3	10
V840G	64	40,1	9,2
V840F/F	64	40,1	9,2

B-handle

V840G/B
V840F/B

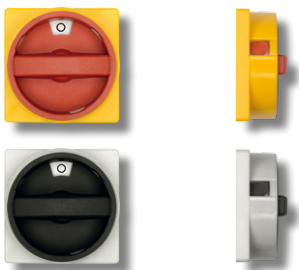

For 3 padlocks Size S1 (64 x 64)

For 4 padlocks Size S1 (64 x 64)

Padlock device with integrated B-handle. Handles are available in black, red and electro-grey, cover discs in black, yellow and electro-grey.

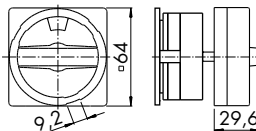

Smallest padlock device

V840K



For 1 padlock Size S00 (Bail diameter 3,5-5 mm)

2-hole panel and single hole mounting 22 mm (16 mm not possible).

Handles are available in red and black, cover discs in yellow and electro-grey.

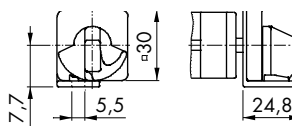

CONTROL SWITCHES AND LOAD SWITCHES

Terminal lugs

M900



With screw terminal (C80 + C125)

Makes it easier to connect hard-to-reach terminals. Generally all X-, L-switches and switches of series C315 and C316 will be delivered with terminal lugs.

M930



To connect with a push-on contact
(CA4, CH6/B, CH10/B, CH16/B, DH10/B, DH12/B)

On each plug connection can be plugged one push-on contact with 6.3 mm or two with 2.8 mm. Switch type CA4 only can be plugged one 2.8 mm push-on contact.

Shaft extensions with asymmetric profile

Ordering data: Length of shaft or enclosure or rather switch cabinets.

L100

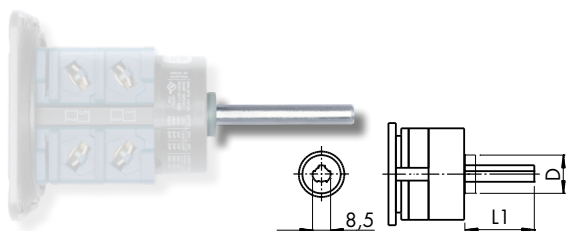

Shaft not adjustable (Size S0 + S1) Escutcheon plate/handle size S1

Size	E/EF	KN1/KD1	KD2	VE	Size	D
S0	L1-2,3	L1-5,1	-	L1	S0	13,8
S1	L1-2,5	-	L1-2,5	L1	S1	18,5

Size	L1	L1	L1	L1	L1	L1	L1	L1	L1
S0	19	24	28	32	37	42	47	52	57
S1	19,8	23,8	27,8	32,8	37,8	42,8	47,8	52,8	57,8

Size	L1	L1	L1	L1	L1	L1	L1	L1	L1
S0	62	67	72	77	82	87	92	97	102
S1	62,8	67,8	72,8	77,8	82,8	87,8	92,8	97,8	102,8

M004D

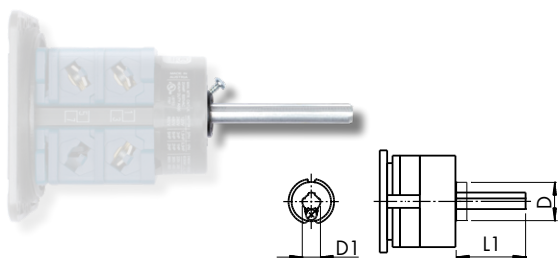

Unlimited adjustable, with set screw (Size S0 – S3)

Adjustable shaft can be set to the desired length in a pre-mounted switch with VE Mounting plate.

Size	D	D1	L1	L1	L1	L1
S0	13,8	6	21-40	41-60	61-80	81-100
S1	18,5	8,5	21-40	41-60	61-80	81-100
S2	24,6	11,2	41-70	71-100	101-130	131-160
S3	35,1	14	41-75	76-110	111-145	146-180

Shaft extensions with square profile

Ordering data: Length of shaft or enclosure or rather switch cabinets.

L100A

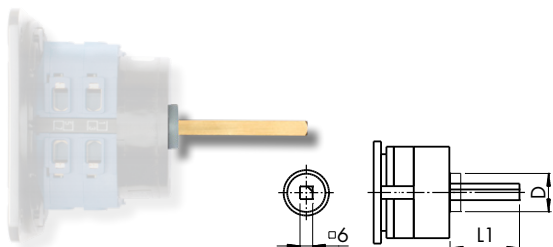

Shaft not adjustable (Size S0 + S1) Escutcheon plate/handle size S1

Size	D
S0	13,8
S1	18,5

Size	L1
S0, S1	19-27 (in 4 mm increments)
S0, S1	32-117 (in 5 mm increments)

M004E

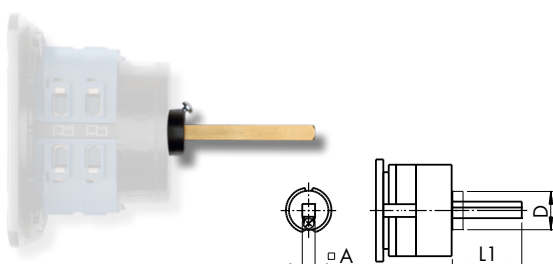

Unlimited adjustable, with set screw (Size S1 – S3)

Adjustable shaft can be set to the desired length in a pre-mounted switch with VE Mounting plate.

Size	A	D	L1	L1	L1	L1
S1	6	18,5	21-40	41-60	61-80	81-100
S2	8	24,6	41-70	71-100	101-130	131-160
S3	10	35,1	41-75	76-110	111-145	146-180



Protective cover Ø 74 mm (incl. holding frame), IP 42

S0.M999/D-760S
S0.M999/D-780S

black
Two or Four hole panel as well as single hole mounting



	CH10, CH11, CH16	CA10, CA11, CAD11, DH10, DH11	CA20, CA25	KG10A	Order number
	E, EF, E22, EG, EGF, FT1, FT2, FT3, FT4, FT6				
H	Number of stages				
60	1-2	1-4	1-3	1-3	S0.M999/D-760S
80	3-6	5-6	4	4	S0.M999/D-780S

S1.M999/D-760S
S1.M999/D-780S



	CH10B, CH11B, CH16B	CA10B, CA11B, CAD11B, DH10B, DH11B	CA20B, CA25B	KG10B	Order number
	E, EF, E22				
H	Number of stages				
60	1-2	1-4	1-3	1-3	S1.M999/D-760S
80	3-4	5-6	4	4	S1.M999/D-780S

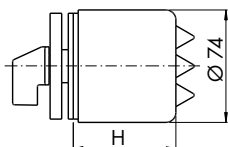

Ordering example:

CA10.A202.E
S0.M999/D-760S

Protective cover Ø 52 mm (incl. holding frame), IP 30

S0.M999/D-546T
S0.M999/D-562T
S0.M999/D-576T

transparent
Two or Four hole panel as well as single hole mounting



	CA10, CA11, CAD11	Order number
	E, EF, E22, EG, EGF, FT1, FT2, FT3, FT4, FT6	
H	Number of stages	
46	1-2	S0.M999/D-546T
62	3-4	S0.M999/D-562T
76	5	S0.M999/D-576T

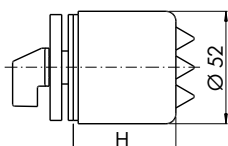

Ordering example:

CA10.A202.E
S0.M999/D-546T

CONTROL SWITCHES AND LOAD SWITCHES

Accessory single hole mounting

**Nut key for mounting screw,
Single hole mounting 16, 22 and 30 mm**

S00.T170.09



**Adapter ring for single hole mounting
16 mm up to Ø 22 mm**

S00.T160.01

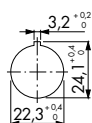

**Adaptor ring for single hole mounting
22 mm to Ø 30 mm**

SOE.T160.01

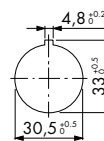

Mounting screw for 5 - 8 mm switch panel, 22 mm

SOE.T170.09



Metal ring to increase the key recess, 22 mm

S1D.V844.05



Mounting screws



Usually included in package content

Self-tapping screws 4,7x13

S1E.T100.N 4-pack

S1E.T100.10 1 piece

For higher wall thickness

Self-tapping screws 4,7x19

S1E.T100.11 1 piece

Self-tapping screws 4,7x30

S1E.T100.13 1 piece



Blank cover

For four hole mounting (drill hole pattern 36 x 36). Order both items.

S0.F990/A1B-PEL



Face plate ungraved incl. frame

S0C.F000.36



Cover for face plate
(available in black)

For single hole mounting 22 mm

P.SN/B



Grey, RAL 7035

P.SB/B



Black, RAL 9005

For handle fixing screw

S0C.G000.11



Black for handle and **S0C.G251**
S0C.G521

S0C.G000.12

Red for handle and **S0C.G252**
S0C.G522

S0C.G000.31

Black for handle and **S1B.G251**
S1B.G521

S0C.G000.32

Red for handle and **S1B.G252**
S1B.G522



CONTROL SWITCHES AND LOAD SWITCHES

Escutcheon plate

The escutcheon plate consists of an escutcheon plate frame and Face plate (brushed Alu).

square escutcheon plate

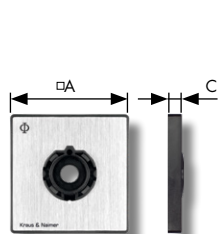

Size	Mounting	A	C
S00	E	30	5,5
	FS2	30	7,2
S0	E	48	6,7
	FT2	48	7,4
S1	E	64	7,4
	FH3	64	7,4
S2	E	88	8,5
	EL2	88	5,8
S3	E	130	11,5

rectangular escutcheon plate

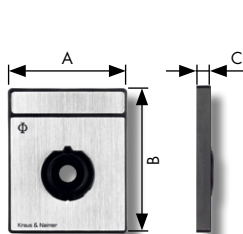

Size	Mounting	A	B	C
S00	E	30	39	5,5
	FS2	30	39	7,2
S0	E	48	59	6,7
	FT2	48	59	7,4
S1	E	64	78,5	7,4
	FH3	64	78,5	7,4
S2	E	88	124	8,5
	EL2	88	124	5,8
S3	E	130	180	11,5

Size	4-hole mounting				Single hole mounting
	square escutcheon plate (incl. Face plate) (F... = Selection of escutcheon plate lettering on these two pages)	square face plate	square escutcheon plate frame	rectangular escutcheon plate frame	square face plate (F... = Selection of escutcheon plate lettering on these two pages)
S00	S00.F.../A1B-PE	S00.F.../A10-P1	S00.F000.51	S00.F000.61	S00.F.../A10-E1
S0	S0.F.../A1B-PEL	S0.F.../A10-P1L	S0E.F000.51	S0E.F000.61	S0.F.../A10-E1L
S1	S1.F.../A1B-PEL	S1.F.../A10-P1L	S1E.F000.51	S1E.F000.61	S1.F.../A10-E1L
S2	S2.F.../A1B-PEL	S2.F.../A10-P1L	S2E.F000.51	-	-
S3	S3.F.../A1B-PEL	S3.F.../A10-P1L	S3E.F000.51	-	-

Rectangular Face plates



Size	Inscription	
	front side	rear side
S00	S00.F991/A00/C-P2B	S00.F991/A00-P2B
S0	S0.F991/A00/C-P2B	S0.F991/A00-P2B
S1	S1.F991/A00/C-P2B	S1.F991/A00-P2B

Standard escutcheon plate letterings

Individual engravings possible. Please use "Form for customized escutcheon plates" on chapter [Useful information](#)

Switching angle 30°

F022	F023	F026	F153	F169	F024	F025	F034	F039	F258
F259	F273	F053	F161	F306	F307	F001	F052	F229	F355
F301	F302	F002	F055	F305	F054	F003	F138	F308	F004
F014	F017	F135	F303	F304	F348	F005	F044	F136	F006
F010	F015	F007	F011	F008	F012	F016	F009	F013	F748



Optional extras

Standardized escutcheon plate letterings

Individual engravings possible. Please use "Form for customized escutcheon plates" on chapter *Interesting facts*

Switching angle 45°

F747	F215	F216	F738	F793	F107	F109	F217	F289	F330
F375	F376	F383	F778	F781	F105	F108	F112	F293	F741
F791	F795	F110	F106	F294	F785	F788	F111	F322	

Switching angle 60°

F070	F088	F197	F379	F380	F470	F754	F072	F234	F264
F288	F291	F313	F382	F721	F758	F075	F076	F356	F357
F071	F073	F080	F081	F085	F241	F249	F260	F274	F312
F316	F324	F331	F354	F364	F373	F381	F385	F469	F732
F735	F077	F102	F309	F361	F362	F363	F365	F366	F078
F074	F082	F256	F079	F083	F084	F242	F283	F737	

Switching angle 90°

F056	F063	F068	F134	F251	F456	F058	F069	F182	F208
F254	F360	F458	F700	F743	F057	F061	F209	F437	F445
F719	F059	F060	F062	F202	F206	F265	F266	F718	F756

Diverse

F119	F122	F125	F225	F341	F120	F124	F121	F990	F991

Optional extras

CONTROL SWITCHES AND LOAD SWITCHES

Rectangular add-on face plates

When used for switches with single hole mounting, the IP is reduced to IP42.

Face plates can be engraved or printed front or rear side. Two different height are available. The escutcheon plate frame is black, the face plate brushed alu. For switches of size S0-S3 are yellow face plates available.

For switches with single hole mounting 16, 22 und 30 mm and front ring

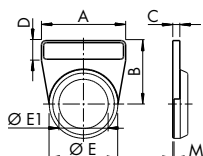

Size	Inscription		Frame without face plate
	front side	rear side	
S00	S00.F991/A0B/C-PRD	S00.F991/A0B-PRD	S00.F000.41
S0	S0.F991/A0B/C-PRD	S0.F991/A0B-PRD	S0C.F000.41

Size	A	B	C	D	E	EI	M
S00	30	25,5	4	10,5	29,5	16	0,7
S0	48	36	4	12	39	22	0,7

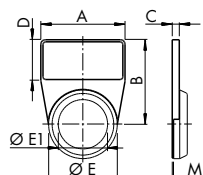

Size	Inscription		Frame without face plate
	front side	rear side	
S00	S00.F991/A0B/C-PRB	S00.F991/A0B-PRB	S00.F000.21
S0	S0.F991/A0B/C-PRB	S0.F991/A0B-PRB	S0C.F000.21

Size	A	B	C	D	E	EI	M
S00	30	35	4	20	29,5	16	0,7
S0	48	48	4	24	39	22	0,7

For switches with four hole and single hole mounting 16, 22 und 30 mm and square escutcheon plate

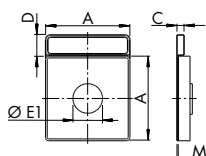

Size	Inscription		Frame without face plate
	front side	rear side	
S00	S00.F991/A0B/C-PRC	S00.F991/A0B-PRC	S00.F000.31
S0	S0.F991/A0B/C-PRC	S0.F991/A0B-PRC	S0C.F000.31
S1	S1.F991/A0B/C-PRC	S1.F991/A0B-PRC	S1D.F000.31

Size	A	C	D	EI	M
S00	30	4	10,5	16	0,7
S0	48	4	12	22	0,7
S1	64	5	15	22/39,7	0,8

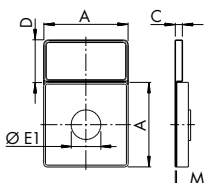

Size	Inscription		Frame without face plate
	front side	rear side	
S00	S00.F991/A0B/C-PRA	S00.F991/A0B-PRA	S00.F000.11
S0	S0.F991/A0B/C-PRA	S0.F991/A0B-PRA	S0C.F000.11
S1	S1.F991/A0B/C-PRA	S1.F991/A0B-PRA	S1D.F000.11
S2	S2.F991/A0B/C-PRA	S2.F991/A0B-PRA	S2D.F000.11
S3	-	S3.F991/A0B-PRA	S3D.F000.11

Size	A	C	D	EI	M
S00	30	4	20	16	0,7
S0	48	4	24	22	0,7
S1	64	5	28	22/39,7	0,8
S2	88	6	36	39,7	1
S3	130	7	50	39,7	1,2

Face plate brushed alu



Size	Inscription	
	front side	rear side
S00	S00.F991/A00/C-P2B	S00.F991/A00-P2B
S0	S0.F991/A00/C-P2B	S0.F991/A00-P2B
S1	S1.F991/A00/C-P2B	S1.F991/A00-P2B



S00	S00.F991/A00/C-P2A	S00.F991/A00-P2A
S0	S0.F991/A00/C-P2A	S0.F991/A00-P2A
S1	S1.F991/A00/C-P2A	S1.F991/A00-P2A
S2	S2.F991/A00/C-P2A	S2.F991/A00-P2A
S3	-	S3.F991/A00-P2A



Handle

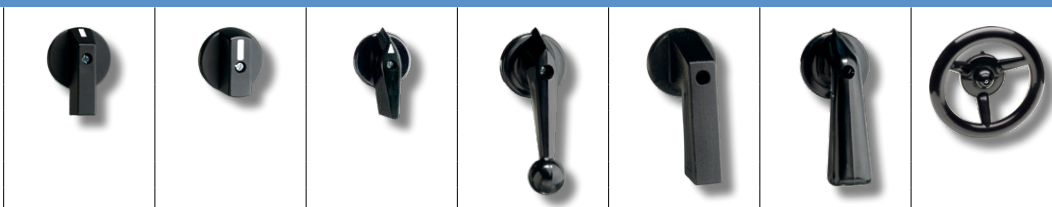

Type of handle I-handle B-handle F-handle K-handle P-handle P-handle Handwheel

Ordering example: SOC.G521 (black B-handle size S0)

Switch size	Order number	Order number for color															
		black		red		black		red		black		red		black		red	
S00	S00 ...	G251	G252	-	-	G221	G222	-	-	-	-	-	-	-	-	-	-
S0	S0C ...	G251	G252	G521	G522	G221	G222	-	-	G211	G212	-	-	-	-	-	-
S1	S1B ...	G251	G252	G521	G522	G221	G222	G411	G412	-	-	G211	G212	-	-	-	-
S2	S2B ...	G251	G252	-	-	G221	G222	G411	G412	-	-	G211	G212	-	-	-	-
S3	S3B ...	G251	G252	-	-	-	-	G411	G412	-	-	G211	G212	G971	-	-	-

Size	A	B	D	A	B	D	A	B	D	A	B	D	A	B	D	A	B	D
S00	16,5	14,8	16	-	-	-	16	18	16	-	-	-	-	-	-	-	-	-
S0	22	23,8	27,6	18	-	27,6	26	26	27,6	-	-	-	39,2	41	27,6	-	-	-
S1	27	31,8	36	23	-	36	33,8	34	36	54	64	36	-	-	-	58	57,5	36
S2	35	43,8	50	-	-	-	44,7	45	50	55	83	50	-	-	-	70	68	50
S3	49	64,8	77,5	-	-	-	-	-	-	75	106	77,6	-	-	-	81	85	77,6

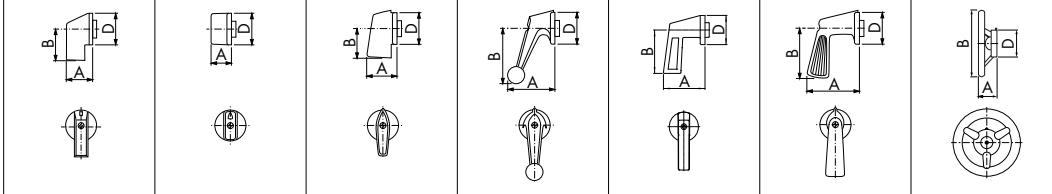

Change of switch program by axial OFFset

Face plate with customized lettering must be specified.



for example with M999/470

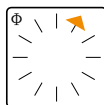

M999/461

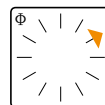

M999/462

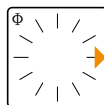

M999/463

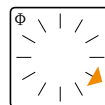

M999/464

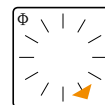

M999/465

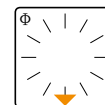

M999/466

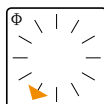

M999/467

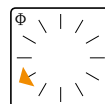

M999/468

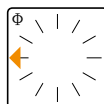

M999/469

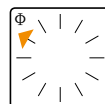

M999/470

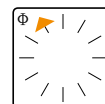

M999/471

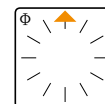

M999/472

Complete items

**2-hole mounting (CG4)
4-hole mounting (CH10)**





**Single hole mounting, IP 66
16/22 mm (CG4), 22 mm (CH10)**



ON/OFF switch, 60° switching angle

0-1

	I_u/I_{th}	Poles	Stages	Switch program see page	Order number	Order number	
	10 A	1	1	97	CG4.A200.E	CG4.A200.FS2	
	20 A				CH10.A200.E	CH10.A200.FT2	
	10 A	2	1	97	CG4.A201.E	CG4.A201.FS2	
	20 A				CH10.A201.E	CH10.A201.FT2	
	10 A	3	2	97	CG4.A202.E	CG4.A202.FS2	
	20 A				CH10.A202.E	CH10.A202.FT2	
	10 A	4	2	97	CG4.A203.E	CG4.A203.FS2	
	20 A				CH10.A203.E	CH10.A203.FT2	
	10 A	6	3	97	CG4.A342.E	CG4.A342.FS2	
	20 A				CH10.A342.E	CH10.A342.FT2	
		10 A	1	1	97	-	CG4.A200*FS2 V750D/2H
		20 A			97	-	CH10.A200.*FT2 V750D/3H



ON/OFF switch, 90° switching angle

0-1

	I_u/I_{th}	Poles	Stages	Switch program see page	Order number	Order number
	10 A	1	1	97	CG4.A290.E	CG4.A290.FS2
	20 A				CH10.A290.E	CH10.A290.FT2
	10 A	2	1	97	CG4.A291.E	CG4.A291.FS2
	20 A				CH10.A291.E	CH10.A291.FT2
	10 A	3	2	97	CG4.A292.E	CG4.A292.FS2
	20 A				CH10.A292.E	CH10.A292.FT2

Double-throw switch without OFF-position („0"), 60° switching angle

1-2

	I_u/I_{th}	Poles	Stages	Switch program see page	Order number	Order number	
	10 A	1	1	97	CG4.A220.E	CG4.A220.FS2	
	20 A				CH10.A220.E	CH10.A220.FT2	
	10 A	2	2	97	CG4.A221.E	CG4.A221.FS2	
	20 A				CH10.A221.E	CH10.A221.FT2	
	10 A	3	3	97	CG4.A222.E	CG4.A222.FS2	
	20 A				CH10.A222.E	CH10.A222.FT2	
	10 A	4	4	97	CG4.A223.E	CG4.A223.FS2	
	20 A				CH10.A223.E	CH10.A223.FT2	
	10 A	5	5	97	CG4.A369.E	CG4.A369.FS2	
	20 A				CH10.A369.E	CH10.A369.FT2	
	10 A	6	6	97	CG4.A370.E	CG4.A370.FS2	
	20 A				CH10.A370.E	CH10.A370.FT2	
		10 A	1	1	97	-	CG4.A220*FS2 V750D/2J
		20 A			97	-	CH10.A220*FT2 V750D/3J
		10 A	2	2	97	-	CG4.A221*FS2 V750D/2J
		20 A			97	-	CH10.A221*FT2 V750D/3J

4-/2-hole mounting

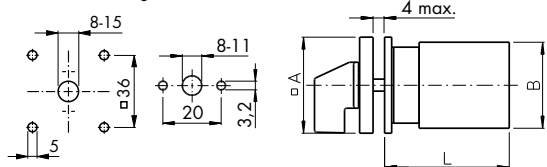

Single hole mounting, IP 66
CG4

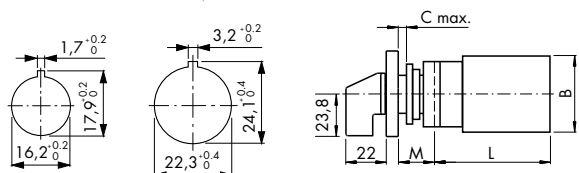

Type	L (Stages)									
	A	B	C	M	1	2	3	4	5	6
CG4	30	28	5	12,5	38,5	50,5	62,5	74,5	86,5	98,5
CH10	48	46	6	18,2	43,5	57,5	71,5	85,5	99,5	113,5

Position to remove the key

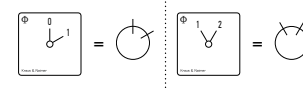

Complete items

**2-hole mounting (CG4)
4-hole mounting (CH10)**



**Single hole mounting, IP 66
16/22 mm (CG4), 22 mm (CH10)**



Double-throw switch with OFF-position („0“), 60° switching angle

1-0-2

	I_U/I_{th}	Poles	Stages	Switch program see page	Order number	Order number	
	10 A	1	1	98	CG4.A210.E	CG4.A210.FS2	
	20 A			98	CH10.A210.E	CH10.A210.FT2	
	10 A	2	2	98	CG4.A211.E	CG4.A211.FS2	
	20 A			98	CH10.A211.E	CH10.A211.FT2	
	10 A	3	3	98	CG4.A212.E	CG4.A212.FS2	
	20 A			98	CH10.A212.E	CH10.A212.FT2	
	10 A	4	4	98	CG4.A213.E	CG4.A213.FS2	
	20 A			98	CH10.A213.E	CH10.A213.FT2	
	10 A	1	1	98	-	CG4.A210*FS2 V750D/2H	CH10.A210*FT2 V750D/3H
	20 A			98	-	CH10.A210*FT2 V750D/3H	
	10 A	2	2	98	-	CG4.A211*FS2 V750D/2H	CH10.A211*FT2 V750D/3H
	20 A			98	-	CH10.A211*FT2 V750D/3H	

Double-throw switch with OFF-position („0“), 60° switching angle

HAND-0-AUTO

	I_U/I_{th}	Poles	Stages	Switch program see page	Order number	Order number
	10 A	1	1	98	CG4.A210.E F085	CG4.A210.FS2 F085
	20 A			98	CH10.A210.E F085	CH10.A210.FT2 F085
	10 A	2	2	98	CG4.A211.E F085	CG4.A211.FS2 F085
	20 A			98	CH10.A211.E F085	CH10.A211.FT2 F085
	10 A	3	3	98	CG4.A212.E F085	CG4.A212.FS2 F085
	20 A			98	CH10.A212.E F085	CH10.A212.FT2 F085

Double-throw switch with OFF-position („0“), 30° switching angle (spring return to center)

1-0-2

	I_U/I_{th}	Poles	Stages	Switch program see page	Order number	Order number
	10 A	1	1	99	CG4.A214.E	CG4.A214.FS2
	20 A			99	CH10.A214.E	CH10.A214.FT2
	10 A	2	2	99	CG4.A215.E	CG4.A215.FS2
	20 A			99	CH10.A215.E	CH10.A215.FT2
	10 A	3	3	99	CG4.A216.E	CG4.A216.FS2
	20 A			99	CH10.A216.E	CH10.A216.FT2

4-/2-hole mounting

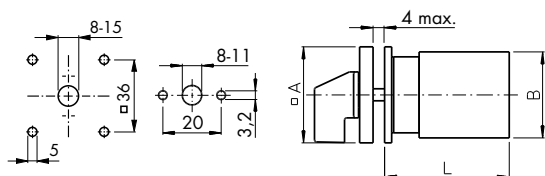

Type	A	B	C	M	L (Stages)			
					1	2	3	4
CG4	30	28	5	12,5	38,5	50,5	62,5	74,5
CH10	48	46	6	18,2	43,5	57,5	71,5	85,5

Single hole mounting, IP 66

CG4

CG4/CH10

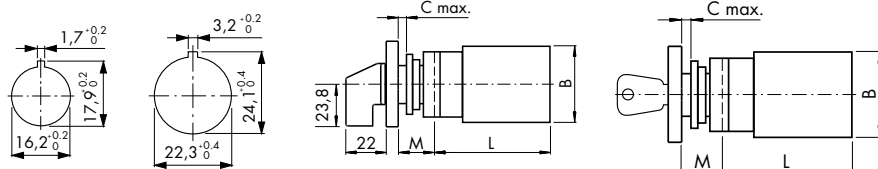

Position to remove the key

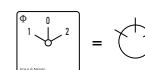

CONTROL SWITCHES AND LOAD SWITCHES

Complete items

**2-hole mounting (CG4)
4-hole mounting (CH10)**



**Single hole mounting, IP 66
16/22 mm (CG4), 22 mm (CH10)**



3-step switch without OFF-position („0“)

1-2-3

	I_u / I_{th}	Poles	Stages	Switch program see page	Order number	Order number
	10 A	1	2	101	CG4.A230.E	CG4.A230.FS2
	20 A			101	CH10.A230.E	CH10.A230.FT2
	10 A	2	3	101	CG4.A250.E	CG4.A250.FS2
	20 A			101	CH10.A250.E	CH10.A250.FT2
	10 A	3	5	101	CG4.A270.E	CG4.A270.FS2
	20 A			101	CH10.A270.E	CH10.A270.FT2
	10 A	1	2	101	-	CG4.A230*FS2 V750D/2J
	20 A			101	-	CH10.A230*FT2 V750D/3J

4-step switch without OFF-position („0“)

1-2-3-4

	I_u / I_{th}	Poles	Stages	Switch program see page	Order number	Order number
	10 A	1	2	101	CG4.A231.E	CG4.A231.FS2
	20 A			101	CH10.A231.E	CH10.A231.FT2
	10 A	2	4	101	CG4.A251.E	CG4.A251.FS2
	20 A			101	CH10.A251.E	CH10.A251.FT2
	10 A	3	6	101	CG4.A271.E	CG4.A271.FS2
	20 A			101	CH10.A271.E	CH10.A271.FT2
	10 A	1	2	101	-	CG4.A231*FS2 V750D/2J
	20 A			101	-	CH10.A231*FT2 V750D/3J

5-step switch without OFF-position („0“)

1-2-3-4-5

	I_u / I_{th}	Poles	Stages	Switch program see page	Order number	Order number
	10 A	1	3	82	CG4.A232.E	CG4.A232.FS2
	20 A			82	CH10.A232.E	CH10.A232.FT2
	10 A	2	5	82	CG4.A252.E	CG4.A252.FS2
	20 A			82	CH10.A252.E	CH10.A252.FT2

6-step switch without OFF-position („0“)

1-2-3-4-5-6

	I_u / I_{th}	Poles	Stages	Switch program see page	Order number	Order number
	10 A	1	3	101	CG4.A233.E	CG4.A233.FS2
	20 A			101	CH10.A233.E	CH10.A233.FT2

4-/2-hole mounting

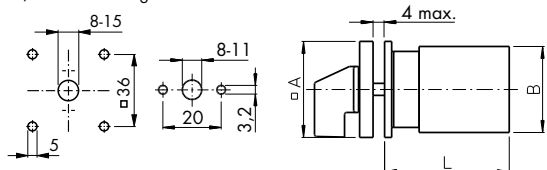

Single hole mounting, IP 66
CG4

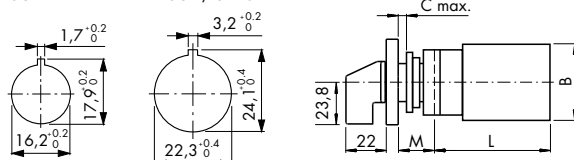

Type	L (Stages)									
	A	B	C	M	2	3	4	5	6	8
CG4	30	28	5	12,5	50,5	62,5	74,5	86,5	98,5	122,5
CH10	48	46	6	18,2	57,5	71,5	85,5	99,5	113,5	141,5

Position to remove the key

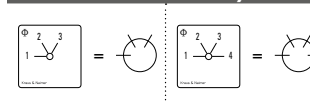

Complete items

**2-hole mounting (CG4)
4-hole mounting (CH10)**



**Single hole mounting, IP 66
16/22 mm (CG4), 22 mm (CH10)**



2-step switch with OFF-position („0“)

0-1-2

	I_u / I_{th}	Poles	Stages	Switch program see page	Order number	Order number
	10 A	1	1	103	CG4.A240.E	CG4.A240.FS2
	20 A			103	CH10.A240.E	CH10.A240.FT2
	10 A	2	2	103	CG4.A260.E	CG4.A260.FS2
	20 A			103	CH10.A260.E	CH10.A260.FT2

3-step switch with OFF-position („0“)

0-1-2-3

	I_u / I_{th}	Poles	Stages	Switch program see page	Order number	Order number
	10 A	1	2	103	CG4.A241.E	CG4.A241.FS2
	20 A			103	CH10.A241.E	CH10.A241.FT2
	10 A	2	3	103	CG4.A261.E	CG4.A261.FS2
	20 A			103	CH10.A261.E	CH10.A261.FT2

4-step switch with OFF-position („0“)

0-1-2-3-4

	I_u / I_{th}	Poles	Stages	Switch program see page	Order number	Order number
	10 A	1	2	103	CG4.A242.E	CG4.A242.FS2
	20 A			103	CH10.A242.E	CH10.A242.FT2

Group switch-3 groups

Switching sequence: 0, A, A+B, A+B+C

	I_u / I_{th}	Poles	Stages	Switch program see page	Order number	Order number
	10 A	1	2	100	CG4.A311.E	CG4.A311.FS2
	20 A			100	CH10.A311.E	CH10.A311.FT2

4-/2-hole mounting

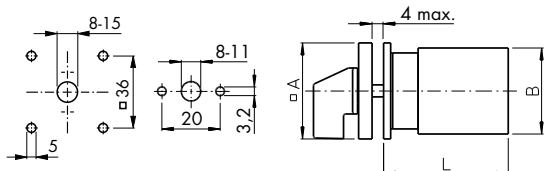

Type	A	B	C	M	1	2	L (Stages)		
CG4	30	28	5	12,5	38,5	50,5	62,5	74,5	86,5
CH10	48	46	6	18,2	43,5	57,5	71,5	85,5	99,5

Single hole mounting, IP 66

CG4

CG4/CH10

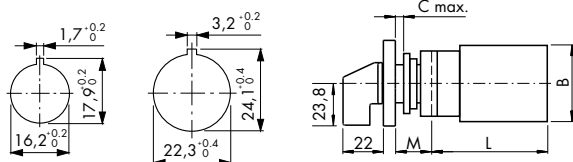

Complete items

**2-hole mounting (CG4)
4-hole mounting (CH10)**



**Single hole mounting IP 66
16/22 mm (CG4), 22 mm (CH10)**



Voltmeter switch without OFF-position („0“) (3 line-to-line voltage)

L1-L2-L3-L3-L1

	I_u / I_{th}	Poles	Stages	Switch program see page	Order number	Order number
			2	105	CG4.A023.E F793	CG4.A023.FS2 F793
				105	CH10.A023.E F793	CH10.A023.FT2 F793

Voltmeter switch without OFF-position („0“) (3 line-to-line voltage, 3 phases against N)

L3-L1-L2-L3-L1-L2-L1-N-L2-N-L3-N

	I_u / I_{th}	Poles	Stages	Switch program see page	Order number	Order number
			3	105	CG4.A025.E F795	CG4.A025.FS2 F795
				105	CH10.A025.E F795	CH10.A025.FT2 F795

Voltmeter switch with OFF-position („0“) (3 line-to-line voltage)

0-L1-L2-L2-L3-L3-L1

	I_u / I_{th}	Poles	Stages	Switch program see page	Order number	Order number
			2	105	CG4.A004.E F778	CG4.A004.FS2 F778
				105	CH10.A004.E F778	CH10.A004.FT2 F778

Voltmeter switch with OFF-position („0“) (3 line-to-line voltage, 3 phases against N)

L3-L1-L2-L3-L1-L2-0-L1-N-L2-N-L3-N

	I_u / I_{th}	Polzahl	Stages	Switch program see page	Order number	Order number
			3	105	CG4.A007.E F785	CG4.A007.FS2 F785
				105	CH10.A007.E F785	CH10.A007.FT2 F785

Ammeter switch (3 transformers with OFF-position, 360° rotation)

0-1-2-3

	I_u / I_{th}	Poles	Stages	Switch program see page	Order number	Order number
	10 A	1	3	86	CG4.A048.E	CG4.A048.FS2
	20 A			86	CH10.A048.E	CH10.A048.FT2

4-/2-hole mounting

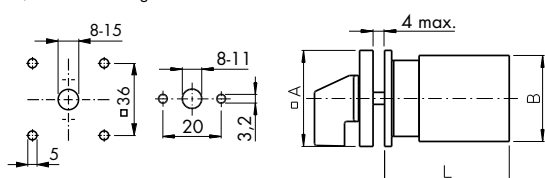

Type	A	B	C	M	L (Stages)	
					2	3
CG4	30	28	5	12,5	50,5	62,5
CH10	48	46	6	18,2	57,5	71,5

Single hole mounting, IP 66

CG4

CG4/CH10

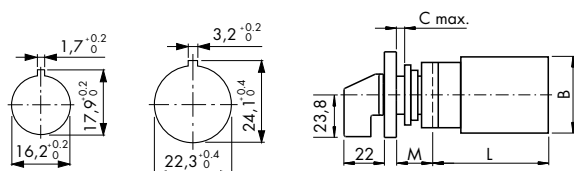

Complete items

**2-hole mounting (CG4)
4-hole mounting (CH10)**



**Single hole mounting, IP 66
16/22 mm (CG4), 22 mm (CH10)**



Control switch – Start switch

START

	I_U/I_{th}	Poles	Stages	Switch program see page	Order number	Order number
	10 A		1	106	CG4.A175.E	CG4.A175.FS2
	20 A			106	CH10.A175.E	CH10.A175.FT2

Control switch – Stop-start switch (with spring return from start to run)

0-1-START

	I_U/I_{th}	Poles	Stages	Switch program see page	Order number	Order number
	10 A		1	106	CG4.A178.E	CG4.A178.FS2
	20 A			106	CH10.A178.E	CH10.A178.FT2

Coding switch binary code (360° rotation)

0-1-2-3-4-5-6-7

	I_U/I_{th}	Poles	Stages	Switch program see page	Order number	Order number
	10 A		2	100	CG4-1.A540.E	CG4-1.A540.FS2
	6 A			100	CH11.A540.E	CH11.A540.FT2

Coding switch binary code

0-1-2-3-4-5-6-7-8-9

	I_U/I_{th}	Poles	Stages	Switch program see page	Order number	Order number
	10 A		2	101	CG4-1.A550.E	CG4-1.A550.FS2
	6 A			101	CH11.A550.E	CH11.A550.FT2

Coding switch binary code (360° rotation)

0-1-2-3-4-5-6-7-8-9-10-11

	I_U/I_{th}	Poles	Stages	Switch program see page	Order number	Order number
	10 A		2	101	CG4-1.A543.E	CG4-1.A543.FS2
	6 A			101	CH11.A543.E	CH11.A543.FT2

4-/2-hole mounting

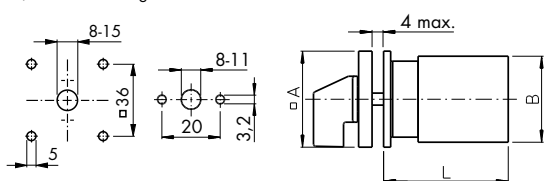

Type	L (Stages)					
	A	B	C	M	1	2
CG..	30	28	5	12,5	38,5	50,5
CH..	48	46	6	18,2	43,5	57,5

Single hole mounting, IP 66

CG4

CG4/CH10

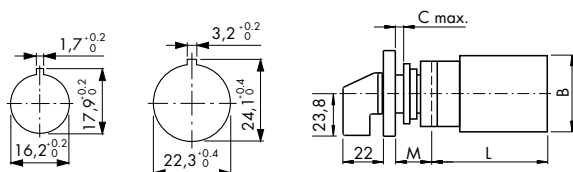



The powerful economy-level product

- Programmable with JMobile software
- Multiple protocols
- OPC UA Server and Client
- CODESYS V3/V2 implemented
- Resistive Touch
- Web-Panel
- Robust design

KN-C 400 Basic

Fast boot <10 sec.

Brilliant display with LED backlight

Ethernet, USB and serial port

Lightweight and low-power design

Support of building automation protocols BACnet IP and MS/TP, KNX IP

CE, cULus, Class I Div. II Hazard certification approval

OpenVPN

Virtual Network Client and Server

Power supply 18 to 32 VDC



Wall Mount Box for KN-C 404, 407 and 410 Basic

- Ready for wall mounting
- Flexible control of building for today and tomorrow
- Control of lights, blinds, temperature, heating, etc.
- Scene programming for a more comfortable life



< Back to the catalog directory >

- ▶ Switches for specific use
- ▶ DC Switches

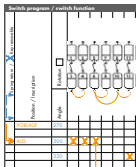

Next >

- Ordering example -

	1. Switch type	2. Switch function	3. Mounting	Optional extras (sub-item)
	Kind of switch and electrical capacity	Switch Function	Mounting of switch	
Page	174 ff.	207 ff.	180 ff.	134 ff.
e.g.	CHR10	D-1234	FT2	CHR10 D-1234*FT2 S0 V750D/3G
				
The switch program number will be created custom specific after assessing the form on page 207.				

- Ordering example if a replacement is required -
The most important data you should know about ordering, in case of replacement.

Labels until 2019



Labels from 2020



2.



Should details not be available or incomplete, send us significant pictures of the switch and the description of the electrical properties according to form on page 207.

Switch type-general view



Size	Escutcheon plate (mm)	Switch type	Possible switching angles	Max. Number of stages
S00	30 x 30	CA4N ¹	45°, 60°, 90°	9
S0	48 x 48	CHR10-CHR16, DHR10, DHR11	30°, 45°, 60°, 90°	12
		DK10, DK11	30°, 60°, 90°	9
S1	64 x 64	G20, G20S	90°	12
		A11, AD11, A25	15°, 20°, 30°, 45°, 60°, 90°	12
S2	88 x 88	CHR10B, CHR16B	30°, 45°, 60°, 90°	12
		A11C, A25C	20°, 30°, 45°, 60°, 90°	12
S3	130 x 130	L350/351, L630/631, L1000/1001, L1250/1251	30°, 45°, 60°, 90°	12
		L400, L600, L800, L1200, L1600, L2000	30°, 45°, 60°, 90°	12

¹Max. totally switching angle with 180° or 360° rotation

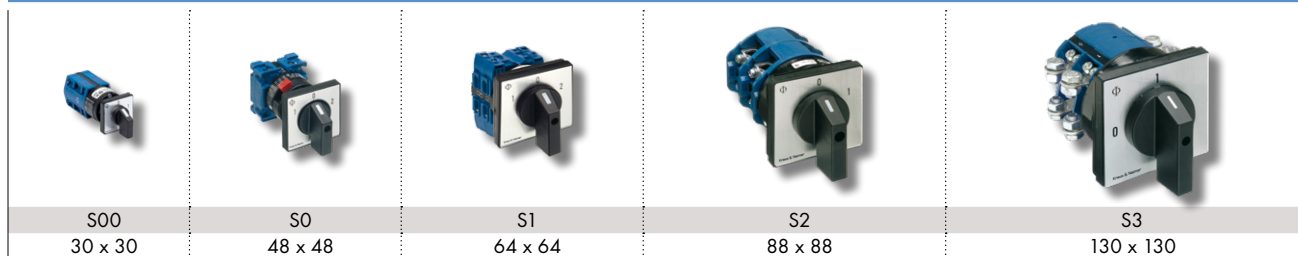
Size

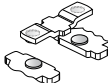
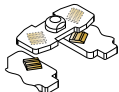
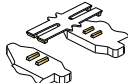

Contact systems

<p>A11, A25 CHR10/16/B DHR10, DK10</p> 	<p>A rigid, double break bridge with silver alloy contacts provides high making and breaking capabilities for regular control applications.</p>	<p>CA4N / CA4N-1</p> 	<p>High contact reliability by multiple cross-point contacts, CA4N with 0,5 μ and CA4N-1 with 5 μ gold plating.</p>
<p>AD11, CHR11/B, DHR11/B, DK11</p> 	<p>High contact reliability by H-bridge design with self-cleaning „cross-wire“ contacts. The contact system with gold-plated contacts are for use for low voltages, electronic compatible and harsh environments.</p>	<p>G20, G20S</p> 	<p>With the G20(S) respectively G20 we have developed a newly designed DC switch. The compact and rugged disconnecter offers numerous application possibilities including photovoltaic inverters.</p>



Freely configurable

Switch types / electrical datas

Quick selection of Switch types / Electrical data	174
Detailed selection of Switch types	176

Switch programs / electrical function

Form for customized switch programs and Face plates	207
---	-----

Mountings

Front panel mounting with 2- or 4-hole mounting	180
Single hole mounting 16/22/30 mm	181
Front panel mounting with escutcheon plate and handle using larger size, Front panel mounting with heavy duty latching and metal shaft	182
Front panel mounting with protective cover, terminal cover	183
Base mounting	184
Dimension L	185

Optional extras

Look from page 134 to 163 for optional extras. Please note size.

Characteristics of Switch types

Turn and Push

The contacts are manually operated by turning and/or pushing. The turn- and push-function could be locked with a programmable push-pull interlock, so that e.g. turning just possible with pushed handle.

DK-series



Up to 48 contacts (4 each stage), up to 24 switch positions

The A-series could be used, when you need switch programs up to 48 contacts or more than 12 switch positions.

A-series

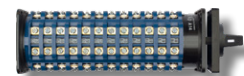

Connection with terminal lugs

With DHR-/DKR-series it's possible to get enclosed contact chambers instead to the standard-series CHR. This series includes patented lugs for easy handling of terminal lugs.

CHR-/DHR-series



7,6 mm lower installation depth in opposite of Type CA4

Compared of Switch type CA4 a lower installation depth of 7,6 mm is possible.

CA4N
CA4N-1



Rated Thermal current from 350 to 2400 A

Switches of the L-series are compact switches for higher currents up to 2400 A. They are applied for connect or disconnect of resistiv, moderate inductive oder under no-load conditions.

L-series

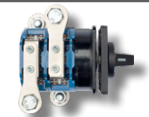

DC-switch up to 1000 V / 20 A with snap on latching and knife contacts

Operational power of 1000 V DC / 20 A combined with high short circuit protection can also be used for AC applications with low currents and voltages. Possible functions: 0-1, 1-2, 1-0-2, with max.12 contacts

G20, G20S



SWITCHES FOR SPECIFIC USE AND DC SWITCHES

Quick selection switch types

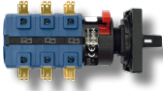

Switches to turn and push

Type	Thermal current	Operation voltage U_e	Operational power 380 V-440 V AC-23A AC-3	Size Face plate	Standard type	H-bridge gold	Enclosed contact chambers	Switching by turn/push
 <i>DK10</i>	16 A	20-690 V		<input type="checkbox"/> 48 mm S0	●		●	●
<i>DK11</i>	6 A	1 ¹ -600 V		<input type="checkbox"/> 48 mm S0		●	●	●
<i>DK10-1</i>	16 A	20-690 V		<input type="checkbox"/> 48 mm S0	Switches with gold-plated contacts		●	●
 <i>DK10-4</i>	16 A	20-690 V		<input type="checkbox"/> 48 mm S0	Switches with quick connects		●	●

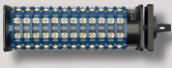
Up to 48 contacts (4 per stage), up to 24 switch positions

Type	Thermal current	Operation voltage U_e	Operational power 380 V-440 V AC-23A AC-3	Size Face plate	Standard type	H-bridge gold
 <i>A11</i>	20 A	690 V	7,5 kW 5,5 kW	<input type="checkbox"/> 64 mm S1	●	
<i>A11C</i>	20 A	690 V	7,5 kW 5,5 kW	<input type="checkbox"/> 88 mm S2		
<i>A25</i>	25 A	690 V	11 kW 7,5 kW	<input type="checkbox"/> 64 mm S1	●	
<i>A25C</i>	25 A	690 V	11 kW 7,5 kW	<input type="checkbox"/> 88 mm S2		
<i>AD11</i>	6 A	1 ¹ -600 V		<input type="checkbox"/> 64 mm S1		●

Switches for connection with terminal lug

Type	Thermal current	Operation voltage U_e	Operational power 380 V-440 V AC-23A AC-3	Size Face plate	Standard type	H-bridge gold	Enclosed contact chambers	Switching by turn/push
 <i>CHR10</i>	20 A	690 V	7,5 kW 5,5 kW	<input type="checkbox"/> 48 mm S0	●			
<i>CHR16</i>	25 A	690 V	11 kW 7,5 kW	<input type="checkbox"/> 48 mm S0	●			
<i>CHR11</i>	6 A	600 V		<input type="checkbox"/> 48 mm S0		●		
<i>DHR10</i>	16 A	20-690 V		<input type="checkbox"/> 48 mm S0			●	
<i>DHR11</i>	6 A	1 ¹ -600 V		<input type="checkbox"/> 48 mm S0		●	●	
 <i>CHR10B</i>	20 A	690 V	7,5 kW 5,5 kW	<input type="checkbox"/> 64 mm S1				
<i>CHR16B</i>	25 A	690 V	11 kW 7,5 kW	<input type="checkbox"/> 64 mm S1				
<i>DHR11B</i>	6 A	1 ¹ -600 V		<input type="checkbox"/> 64 mm S1		●	●	

¹ Values for lower voltages On request.



Quick selection switch types

7,6 mm lower installation depth in opposite of Type CA4

Type	Thermal current	Operation voltage U_e	Operational power 380 V-440 V AC-23A AC-3		Size Face plate	Standard type	Contacts gold-plated
 CA4N	10 A	440 V	3 kW	2,2 kW	□ 30 mm S00	•	
CA4N-1	10 A	440 V	3 kW	2,2 kW	□ 30 mm S00		•

Switches up to 350 to 2400 A

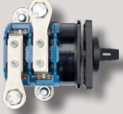
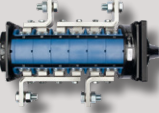
Type	Thermal current	Operation voltage U_e	Operational power 380 V-440 V AC-23A AC-3		Size Face plate	Standard type
L350	350 A	690 V	90 kW	37 kW	□ 88 mm S2	•
 L351	350 A	690 V	90 kW	37 kW	□ 88 mm S2	
L630	630 A	690 V	90 kW	37 kW	□ 88 mm S2	•
L631	630 A	690 V	90 kW	37 kW	□ 88 mm S2	
L1000	1000 A	690 V	90 kW	37 kW	□ 88 mm S2	•
L1250	1250 A	690 V	90 kW	37 kW	□ 88 mm S2	•
L1251	1250 A	690 V	90 kW	37 kW	□ 88 mm S2	
L400	500 A	690 V	132 kW	55 kW	□ 130 mm S3	
L600	800 A	690 V	132 kW	55 kW	□ 130 mm S3	
 L800	1100 A	690 V	132 kW	55 kW	□ 130 mm S3	
L1200	1450 A	690 V	132 kW	55 kW	□ 130 mm S3	•
L1600	1900 A	690 V	132 kW	55 kW	□ 130 mm S3	•
L2000	2400 A	690 V	132 kW	55 kW	□ 130 mm S3	•

DC-switch up to 1000 V / 20 A with snap on latching and knife contacts

Type	Operational current U_e	Operation voltage U_e	Size Face plate
 G20/S	20 A DC	1000 V	□ 48 mm S0



SWITCHES FOR SPECIFIC USE AND DC SWITCHES

Switch types acc. IEC 60947-3, EN 60947-3, VDE 0660 Part 107, USA / Kanada				CA4N CA4N-1	AT1/C	A25/C	AD11	CHR10/B	CHR11		
Rated uninterrupted current I_U/I_{th}											
IEC 60947-3, EN 60947-3, VDE 0660 Part 107				A	10	20	25	6	20	6	
USA / Kanada ²				A	10	10	25	6	20	6	
Rated operational voltage U_e ¹											
IEC 60947-3, EN 60947-3, VDE 0660 Part 107				V	440	690	690	600	690	600	
USA / Kanada ²				V	300	600	600	600	600	300	
Min. Voltage				V	-	20	20	1	-	1 ⁶	
Rated impulse withstand voltage U_{imp}											
				kV	4	6	6	On request	6	On request	
Rated operational current I_e											
AC-21A	Switching of resistive loads, with moderate overloads	IEC 60947-3, EN 60947-3, VDE 0660 Part 107	1 V	A	-	-	-	6	6		
			6/12 V	A	-	-	-	3/2	3/2		
			24/48 V	A	10	20	25	1/0,8	1/0,8		
			110/220 V	A	10	20	25	0,4/0,2	0,4/-		
			380/440 V	A	10	20	25	0,13/0,1	-/-		
500/600 V	A	-	20	25	0,08/0,05	0,08/0,05					
660/690 V	A	-	20	25	-	-/-					
AC-22A	Switching of combined resistive or low inductive loads including moderate overloads	IEC 60947-3, EN 60947-3, VDE 0660 Part 107	220 V-500 V	A	10	20	25	-	-		
			220 V-440 V	A	-	-	-	-	20		
			660 V-690 V	A	-	16	25	-	16		
			500 V	A	-	-	-	-	20		
AC-15	Switching of magnetic drives, contactors, valves and electrical magnets	IEC 60947-3, EN 60947-3, VDE 0660 Part 107	110 V	A	-	-	-	-	5		
			220 V-240 V	A	2,5	6	8	-	5		
			380 V-440 V	A	1,5	4	5	-	4		
Pilot duty				Heavy	VAC	A300	600	600	-	A600	-
Ampere rating				Resistive or low inductive loads	A	10	10	25	see AC21-A	20	-
Rated utilization category											
AC-2	Slip-ring induction motor starting, reversing, plugging and star-delta starting (CHR10B)	IEC 60947-3, EN 60947-3, VDE 0660 Part 107	3 phase, 3 pole	220 V-240 V	kW	2,5	4	5,5	-	4	-
				380 V-440 V	kW	4,5	7,5	11	-	7,5	-
				500 V	kW	-	10	15	-	10	-
				660 V-690 V	kW	-	10	13	-	10	-
AC-3	Direct-on-line starting of squirrel-cage motors, stardelta starting (CHR16B)	IEC 60947-3, EN 60947-3, VDE 0660 Part 107	3 phase, 3 pole	220 V-240 V	kW	1,5	3	4	-	3	-
				380 V-440 V	kW	2,2	5,5	7,5	-	5,5	-
				500 V	kW	-	5,5	7,5	-	5,5	-
				660 V-690 V	kW	-	5,5	7,5	-	5,5	-
			1 phase, 2 pole	110 V-120 V	kW	0,3	0,6 (110 V)	1,5 (110 V)	-	0,6	-
				220 V-240 V	kW	0,55	2,2	3	-	2,2	-
				380 V-440 V	kW	0,75	3	3,7	-	3	-
				500 V	kW	-	-	-	-	3	-
				660 V-690 V	kW	-	-	-	-	3	-
AC-4	Starting of squirrel-cage motors, reversing, plugging and inching	IEC 60947-3, EN 60947-3, VDE 0660 Part 107	3 phase, 3 pole	220 V-240 V	kW	0,37	0,55	1	-	0,55	-
				380 V-440 V	kW	0,55	1,5	2,2	-	1,5	-
				500 V	kW	-	1,5	2,5	-	1,5	-
				660 V-690 V	kW	-	1,5	2,5	-	1,5	-
			1 phase, 2 pole	110 V-120 V	kW	0,15	0,15 (110 V)	0,2 (110 V)	-	0,3	-
				220 V-240 V	kW	0,25	0,25	0,5	-	0,75	-
				380 V-440 V	kW	0,5	0,55	0,8	-	1,5	-
				500 V	kW	-	-	-	-	-	-
AC-23A	Frequent switching motors or other high inductive loads	IEC 60947-3, EN 60947-3, VDE 0660 Part 107	3 phase, 3 pole	220 V-240 V	kW	1,8	3,7	5,5	-	3,7	-
				380 V-440 V	kW	3	7,5	11	-	7,5	-
				500 V	kW	-	7,5	11	-	7,5	-
				660 V-690 V	kW	-	7,5	11	-	7,5	-
			1 phase, 2 pole	110 V-120 V	kW	0,37	0,75 (110 V)	1,5 (110 V)	-	0,75	-
				220 V-240 V	kW	0,75	3	3	-	2,5	-
				380 V-440 V	kW	1,1	3,7	5,5	-	3,7	-
				500 V	kW	-	-	-	-	4	-
660 V-690 V	kW	-	-	-	-	4	-				
	Standard motor load DOL-Rating (similar AC-3)	UL / Kanada	3 phase, 3 pole	110 V-120 V	HP	0,75	1	1,5	-	1,5	-
				220 V-240 V	HP	1	1	3	-	3	-
				440 V-480 V	HP	-	1	7,5	-	5	-
				550 V-600 V	HP	-	1	10	-	5	-
				110 V-120 V	HP	0,33	0,5	0,75	-	0,5	-
220 V-240 V	HP	0,75	1	1,5	-	1	-				
277 V	HP	0,75	1	2	-	2	-				
440 V-480 V	HP	1	1	3	-	2	-				
550 V-600 V	HP	-	1	5	-	2	-				
Short circuit protection											
Max. fuse size				gL/gG-Characteristic	A	10	20	35	6	-	6 ⁷
				gL-Characteristic	A	-	-	-	-	25	-
Rated short-time withstand current				(1s-current)	A	60	120	220	45	220	50
Max. permissible wire gage (use copper wire only)											
Single-core or stranded wire (AWG)				mm ²	1,5	2,5 (12)	4 (10)	2,5 (14)	-	-	
Flexible wire				mm ²	1,5	2,5	2,5	2,5	-	-	
Flexible wire sleeving in accordance with DIN 46228				mm ²	1	2,5	2,5	2,5	-	-	
AWG wire (without sleeve)				AWG	16	14	12	14	-	-	
Connection with isolated terminal and spade lugs											
Inside cable diameter				mm	-	-	-	-	-	≥3,6	≥3,6
Outside cable diameter				mm	-	-	-	-	-	≤8,6	≤8,6
Connection with isolated quick connections				mm	-	-	-	-	-	6,3	6,3
Ambient temperature of stages ^{4, 5}											
open at 100 % I_U/I_{th}										55 °C over 24 hours with peaks up to 60 °C	
enclosed at 100 % I_{the}										35 °C over 24 hours with peaks up to 40 °C	

¹ Valid for lines with common neutral termination, overvoltage category III, pollution degree 3. Values for other supply systems Upon request. | ² International Standards and Approvals, refer to page 192 | ³ 16 A bei 150 V und 10 A bei 300 V für CG8 | ⁴ For electromagnetic optional extras see additional data in the chapter **OPTIONAL EXTRAS.** | ⁵ Storage temperature: -40 °C to 85 °C (in case of temperature below -5 °C no shock load permissible). | ⁶ Lower values On request. | ⁷ G-fuse, swift

Detailed selection switch types



Switch types acc. IEC 60947-3, EN 60947-3, VDE 0660 Part 107, USA / Kanada

		CHR16/B	DHR10	DHR11/B	DK10	DK11
Rated uninterrupted current I_U/I_{th}						
IEC 60947-3, EN 60947-3, VDE 0660 Teil 107		A	25	16	6	16
USA / Kanada ²		A	25	15	6	15
Rated operational voltage U_e¹						
IEC 60947-3, EN 60947-3, VDE 0660 Teil 107		V	690	690	600	690
USA / Kanada ²		V	600	600	600	600
Min. Voltage		V	-	-	1 ⁶	1 ⁶
Rated impulse withstand voltage U_{imp}						
		kV	6	6	Auf Anfrage	6
Rated operational current I_e						
AC-21A	Switching of resistive loads, with moderate overloads	IEC 60947-3, EN 60947-3, VDE 0660 Part 107	1 V A 6/12 V A 24/48 V A 110/220 V A 380/440 V A 500/600 V A 660/690 V A	25	16	6 3/2 1/0,8 0,4/0,2 0,13/0,1 0,09/0,05 -/-
AC-22A	Switching of combined resistive or low inductive loads including moderate overloads	IEC 60947-3, EN 60947-3, VDE 0660 Part 107	220 V-500 V A 220 V-440 V A 660 V-690 V A 500 V A	- 25 25 25	- - - -	- - - -
AC-15	Switching of magnetic drives, contactors, valves and electrical magnets	IEC 60947-3, EN 60947-3, VDE 0660 Part 107	110 V A 220 V-240 V A 380 V-440 V A	8 8 5	5 5 3	5 5 3
Pilot duty			Heavy	VAC	A600	600
Ampere rating Resistive or low inductive loads			A	25	15	15
Rated utilization category						
AC-2	Slip-ring induction motor starting, reversing, plugging and star-delta starting (CHR10B)	IEC 60947-3, EN 60947-3, VDE 0660 Teil 107	3 phase, 3 pole 220 V-240 V kW 380 V-440 V kW 500 V kW 660 V-690 V kW	5,5 11 15 13	- - - -	- - - -
AC-3	Direct-on-line starting of squirrel-cage motors, star-delta starting (CHR16B)	IEC 60947-3, EN 60947-3, VDE 0660 Teil 107	3 phase, 3 pole 220 V-240 V kW 380 V-440 V kW 500 V kW 660 V-690 V kW	4 7,5 7,5 7,5	2,2 3,7 3,7 3,7	2,2 3,7 3,7 3,7
			1 phase, 2 pole 110 V-120 V kW 220 V-240 V kW 380 V-440 V kW 500 V kW 660 V-690 V kW	1,5 3 3,7 4 3,7	0,37 1,1 2,2 -	0,37 1,1 2,2 -
AC-4	Starting of squirrel-cage motors, reversing, plugging and inching	IEC 60947-3, EN 60947-3, VDE 0660 Teil 107	3 phase, 3 pole 220 V-240 V kW 380 V-440 V kW 500 V kW 660 V-690 V kW	1,5 3 3 3	- - - -	- - - -
			1 phase, 2 pole 110 V-120 V kW 220 V-240 V kW 380 V-440 V kW	0,45 1,1 2,2	- - -	- - -
AC-23A	Frequent switching motors or other high inductive loads	IEC 60947-3, EN 60947-3, VDE 0660 Teil 107	3 phase, 3 pole 220 V-240 V kW 380 V-440 V kW 500 V kW 660 V-690 V kW	5,5 11 11 11	3 5,5 5,5 4	3 5,5 5,5 4
			1 phase, 2 pole 110 V-120 V kW 220 V-240 V kW 380 V-440 V kW 500 V kW 660 V-690 V kW	1,5 3 5,5 5,5 5,5	0,55 1,5 2,5 -	0,55 1,5 2,5 -
	Standard motor load DOL-Rating (similar AC-3)	UL / Kanada	3 phase, 3 pole 110 V-120 V HP 220 V-240 V HP 440 V-480 V HP 550 V-600 V HP	2 5 10 10	0,75 1,5 3 3	0,75 1,5 3 3
			1 phase, 2 pole 110 V-120 V HP 220 V-240 V HP 277 V HP 440 V-480 V HP 550 V-600 V HP	1 2 3 5 5	0,25 0,5 0,5 1 1	0,25 0,5 0,5 1 1
Short circuit protection						
Max. fuse size			gL/gG-Characteristic gL-Characteristic	A A	- 35	- 16
Rated short-time withstand current			(1s-current)	A	250	120
Max. permissible wire gage (use copper wire only)						
Single-core or stranded wire				mm ²	-	-
Flexible wire				mm ²	-	-
Flexible wire sleeving in accordance with DIN 46228				mm ²	-	-
AWG wire (without sleeve)				AWG	-	-
Connection with isolated terminal and spade lugs						
Inside cable diameter				mm	≥3,6	≥3,2
Outside cable diameter				mm	≤8,6	≤7,4
Connection with isolated quick connections				mm	6,3	6,3
Ambient temperature of stages^{4, 5}						
open at 100 % I _U /I _{th}						55 °C over 24 hours with peaks up to 60 °C
enclosed at 100 % I _{th}						35 °C over 24 hours with peaks up to 40 °C

¹ Valid for lines with common neutral termination, overvoltage category III, pollution degree 3. Values for other supply systems Upon request. | ² International Standards and Approvals, refer to page 192 | ³ 16 A bei 150 V und 10 A bei 300 V für CG8 | For electromagnetic optional extras see additional data in the chapter **OPTIONAL EXTRAS**. | ⁴ Storage temperature: -40 °C to 85 °C (in case of temperature below -5 °C no shock load permissible). | ⁵ Lower values On request. | ⁶ G-fuse, swift



SWITCHES FOR SPECIFIC USE AND DC SWITCHES

Switch types acc. IEC 60947-3, EN 60947-3, VDE 0660 Part 107, USA / Kanada										
						L350 L351	L400	L600	L630 L631	L800
Rated uninterrupted current I_U/I_{th}										
IEC 60947-3, EN 60947-3, VDE 0660 Part 107										
Ambient temperature 35 °C over 24 hours with peaks up to 40 °C					A	350	500	800	630	1100
Ambient temperature 55 °C over 24 hours with peaks up to 60 °C					A	350	500	750	600	950
USA / Kanada ²					A	350	400	630	630	800
Rated operational voltage U_e ¹										
IEC 60947-3, EN 60947-3, VDE 0660 Part 107 ¹					V	690	690	690	690	690
USA / Kanada ²					V	600	600	600	600	600
Rated impulse withstand voltage U_{imp}										
					kV	On request				
Rated operational current I_e										
AC-20A	Connecting and disconnecting under no-load conditions	IEC 60947-3, EN 60947-3, VDE 0660 Part 107		690 V	A	350	500	800	630	1100
AC20-B	Occasional switching under loads $\cos \varphi 0,8$	IEC 60947-3, EN 60947-3, VDE 0660 Part 107	3 phase, 3 pole and 1 phase, 2 pole	220 V–440 V	A	350	500	800	500	1000
				500 V	A	350	450	500	450	630
				660 V–690 V	A	315	350	400	360	400
AC-21B	Switching of combined resistive or low inductive loads including moderate overloads	IEC 60947-3, EN 60947-3, VDE 0660 Part 107	3 phase, 3 pole and 1 phase, 2 pole	220 V–440 V	A	250	450	500	350	630
				500 V	A	250	400	450	315	500
				660 V–690 V	A	200	300	350	250	350
Interrupting rating		UL /C-UL ²		600 V	A	200	300	300	200	300
Rated utilization category										
AC-23B	Occasional switching motors or other high inductive loads	IEC 60947-3, EN 60947-3, VDE 0660 Teil 107	3 phase, 3 pole	220 V–240 V	kW	45	75	75	45	75
				380 V–440 V	kW	90	132	132	90	132
				500 V	kW	110	132	132	110	132
				660 V–690 V	kW	55	55	65	65	65
Short circuit protection										
Max. fuse size		aR-Characteristic		A	400	500	800	630	1100	
Rated short-time withstand current		(1s-current)		A	Auf Anfrage					
Terminals										
Version of bolt terminals on request.										
Ambient temperature of stages ^{4, 5}										
55 °C over 24 hours with peaks up to 60 °C										

¹ Valid for lines with common neutral termination, overvoltage category III, pollution degree 3. Values for other supply systems Upon request. | ² International Standards and Approvals, refer to page 192 | ³ 16 A bei 150 V und 10 A bei 300 V für CG8 | ⁴ For electromagnetic optional extras see additional data in the chapter **OPTIONAL EXTRAS**. | ⁵ Storage temperature: -40 °C to 85 °C (in case of temperature below -5 °C no shock load permissible). | ⁶ Lower values On request. | ⁷ G-fuse, swift

Detailed selection switch types



Direct current switch G20, G20S acc. IEC 60947-3, EN 60947-3, VDE 0660 Part 107										
Type addition "S" means instead of standard latching mechanism for fast and manual independently switching.						G20		G20S		
Utilization category	Series contacts / admissible voltage in Volt						Rated operational current I_e			
	1	2	3	4	5	6				
DC-21A	250	500	750	1000			8		20	
	440	880					4		13	
DC-22A	250	500	750	1000			2		20	
	330	660	990				1		10	
	440	880					0,5		5	
DC-23A	24	48	72	96	120	144	20		20	
	48	96	144	192	240	288	12		20	
	60	120	180	240	300	360	5		15	
	110	220	330	440	550	660	3		12	
	160	320	480	640	800	960	2		8	
	250	500	750	1000			1		5	
	330	660	990				0,5		3	
	440	880					0,25		1	



Switch types acc. IEC 60947-3, EN 60947-3, VDE 0660 Part 107, USA / Kanada					L1000	L1200	L1250 L1251	L1600	L2000	
Rated uninterrupted current I_U/I_{Th}										
IEC 60947-3, EN 60947-3, VDE 0660 Part 107										
Ambient temperature 35 °C over 24 hours with peaks up to 40 °C					A	1000	1450	1250	1900	2400
Ambient temperature 55 °C over 24 hours with peaks up to 60 °C					A	920	1300	1100	1700	2000
USA / Kanada ²					A	1000	1200	1250	1600	2000
Rated operational voltage U_e ¹										
IEC 60947-3, EN 60947-3, VDE 0660 Part 107					V	690	690	690	690	690
USA / Kanada ²					V	600	600	600	600	600
Rated impulse withstand voltage U_{imp}										
					kV				Auf Anfrage	
Rated operational current I_e										
AC-20A	Connecting and disconnecting under non load conditions	IEC 60947-3, EN 60947-3, VDE 0660 Part 107		690 V	A	1000	1450	1250	1900	2400
AC20-B	Occasional switching under load $\cos \varphi 0,8$	IEC 60947-3, EN 60947-3, VDE 0660 Part 107	3 phase, 3 pole and 1 phase, 2 pole	220 V–440 V	A	630	1200	630	1200	1200
				500 V	A	500	800	500	800	800
				660 V–690 V	A	400	400	400	400	400
AC-21B	Switching of combined resistive or low inductive loads including moderate overloads	IEC 60947-3, EN 60947-3, VDE 0660 Part 107	3 phase, 3 pole and 1 phase, 2 pole	220 V–440 V	A	400	800	400	800	800
				500 V	A	350	630	350	630	630
				660 V–690 V	A	300	350	300	350	350
Interrupting rating		UL /C-UL ²		600 V	A	200	300	200	200	200
Rated utilization category										
AC-23B	Occasional switching motors or other high inductive loads	IEC 60947-3, EN 60947-3, VDE 0660 Part 107	3 phase, 3 pole	220 V–240 V	kW	45	75	45	75	75
				380 V–440 V	kW	90	132	90	132	132
				500 V	kW	110	132	110	132	132
				660 V–690 V	kW	65	65	65	65	65
Short circuit protection										
Max. fuse size			aR-Characteristic	A	1000	2 x 800	1250	2 x 1000	2 x 1250	
Rated short-time withstand current			(1s-current)	A				On request		
Terminals										
								Version of bolt terminals on request.		
Ambient temperature of stages ^{4, 5}										
								55 °C over 24 hours with peaks up to 60 °C		

¹ Valid for lines with common neutral termination, overvoltage category III, pollution degree 3. Values for other supply systems Upon request. | ² International Standards and Approvals, refer to page 192 | ³ 16 A bei 150 V und 10 A bei 300 V für CG8 | ⁴ For electromagnetic optional extras see additional data in the chapter **OPTIONAL EXTRAS**. | ⁵ Storage temperature: -40 °C to 85 °C (in case of temperature below -5 °C no shock load permissible). | ⁶ Lower values On request. | ⁷ G-fuse, swift



SWITCHES FOR SPECIFIC USE AND DC SWITCHES

4-hole panel mounting, IP 40
 4-hole panel mounting, IP 66
 2-hole panel mounting, IP 65

E, E-V, ER
 EF, EF-V, ERF
 E22, E22-V

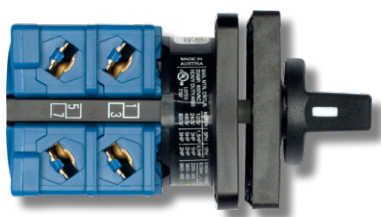

For front mounting you have various options available. Type „ER.“ for installation with additional rear mounting plate. „-V“ indicates that the terminals are rotated 90° clockwise.

	CA4N CA4N-1	CHR10/11/16 DHR10/11	DK10	G20/S	A11, AD11, A25 CHR10B CHR16 DHR11B	A11C, A25C L350/351 L630/631 L1000/L1001 L1250/L1251	L400, L600 L800 L1200 L1600 L2000
Mounting	500 (30x30)	S0 (48x48)			S1 (64x64)	S2 (88x88)	S3 (130x130)
2-Loch, IP 40	E E-V						
2-Loch, IP 66	EF EF-V						
4-Loch, IP 40	E, ER (not CHR..) E-V	E, ER (not CHR..) E-V	E E-V	E E-V	E, ER (not CHR..) E-V (not A..)	E, ER E-V (not A..)	E, ER
4-Loch, IP 66	EF, ERF (not CHR..) EF-V	EF, ERF (not CHR..) EF-V	EF EF-V	EF, ERF (not CHR..) EF-V (not A..)	EF, ERF (not CHR..) EF-V (not A..)	EF, ERF EF-V (not A..)	EF, ERF
2-Loch, IP 65	E22 E22-V			E22 E22-V			

Dimension L on page 185

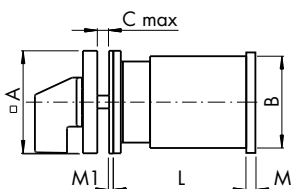

E-V, EF-V for CA4N/-1
 E22 for CHR10/11/16, DHR10/11, G20/S

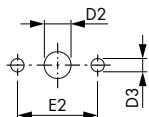

E, EF for CA4N/-1
 E22-V for CHR10/11/16, DHR10/11, G20/S

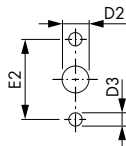

Mounting E, E-V, EF, EF-V, ER, ERF
 For face plate and rear mounting panel

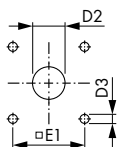

	CA4N CA4N-1	A11 AD11	A25	A11C A25C	CHR10/11 CHR16	CHR10B CHR16B	DHR10/11	DK10/11
A	30	64	64 (88 ¹)	88	48	64	48	48
B	29,5	60	70	84	46	56	42	42
C	4	4	4	5,5	4	4	4	4
D3	3,2	5	5 (6 ¹)	6	5	5	5	5
E1		48	48 (68 ¹)	68	36	48	36	36
E2	20				30		30	
M ¹	1	6,5	7,6	7,6			5,5	
M1								
D2								
E, E-V, ER	8-11	10-15	10-15	13-17	8-15	10-15	8-15	15-19
EF, EF-V, ERF	8-11	19-22	19-22	26-30	15-19	19-22	15-19	
E22, E22-V					11-15		11-15	

	DHR11B	G20/S	L350/351, L630/631 L1000, L1250/L1251	L400, L600, L800 L1200, L1600, L2000
A	64	48	88	130
B	56	37,4 x 41,3	88 ²	126 ²
C	4	4	5,5	7
D3	5	5	6	7
E1	48	36	68	104
E2		30		
M ¹	5,5		27,5	32
M1				
D2				
E, E-V, ER	10-15	8-15	13-17	15,5-20
EF, EF-V, ERF	19-22	15-19	26-30	22-25
E22, E22-V		11-15		

¹ Dimensions for ER and ERF rear mounting panel.
² Additional dimension for terminal lugs see page 180

Mounting



Single hole mounting 16/22/30/40¹ mm, IP 66, IP 69k (FT. + FH.) FH., FH.-V, FS., FS.-V, FT., FT.-V, EL.

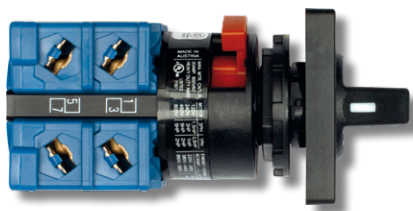

Saving time by using switches with single hole mounting. This type of mounting is fixed about 5 times faster as a conventional four hole panel mounting. All switches with single hole mounting have the high degree of protection IP 66 (not applicable for A11, AD11 and A25). Switches supplied with escutcheon plate or front ring.

An extension ring is enclosed when two drill diameters are specified.

When ordering with the suffix *...-V*, the switches can be supplied with connection terminals rotated 90° clockwise (not applicable for A11, AD11 and A25).

Dimension L on page 185

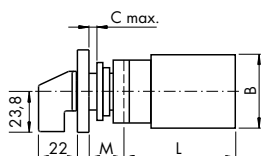

FS1
FT1, FT3
EL1

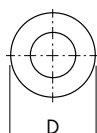

FH3
FS2
FT2, FT4
EL2

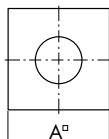

FH4
FS4
FT6
EL4

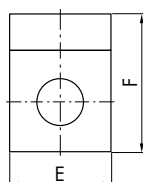

FS1, FS2, FS4

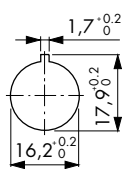

FH3, FH4
FS1, FS2, FS4
FT1, FT2
FT3, FT4, FT6

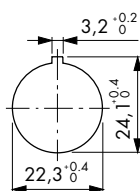

FT3, FT4

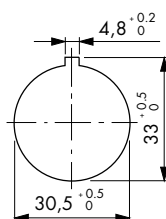

EL1, EL2, EL4

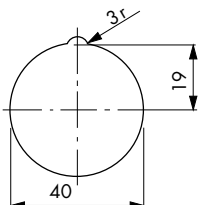

Design	Size	Face plate-/ Ring size	Ø Hole	Code
Front ring	S00	Ø 29,5	16,2 / 22,3	FS1
	S0	Ø 39,4	22,3	FT1
		Ø 39,4	22,3 / 30,5	FT3
	S1	Ø 45	40	EL1 ⁵
Square escutcheon plate	S00	30 x 30	16,2 / 22,3	FS2
	S0	48 x 48	22,3	FT2
			22,3 / 30,5	FT4
	S1 ²	64 x 64	22,3	FH3
	S1	64 x 64	40	EL2 ⁵
Rectangular escutcheon plate	S00	30 x 39	16,2 / 22,3	FS4
	S0	48 x 59	22,3	FT6
	S1 ²	64 x 78,5	22,3	FH4
S1	64 x 78,5	40	EL4 ^{3,5}	

	CA4N/-1	CHR10-CHR16	DHR10-DHR11	DK10-DK11	G20/S	A11-AD11-A25
A/E	30	48	48	48	48	64
A/E (FH3)		64	64	64		
A/E (FH4)		64	64	64		
B	29,5	46	42	42	37,4 x 41,3	60/70 ⁴
C	5	6	6	6	6	1-6,3
D	29,5	39,4	39,4	39,4	39,4	45
F	39	59	59	59	59	78,5
F (FH4)		78,5	78,5	78,5		
M	12,5	18,2	18,2	3,7	18,2	11
M (FH3)		25,2	25,5	3,7		
M (FH4)		25,2	25,5	25,2		

¹ Degree of protection IP40 | ² with heavy duty latching | ³ composed of square escutcheon plate EL2 and rectangular add-on face plate PRC | ⁴ only for A25 | ⁵ only for A11, AD11, A25



Front panel mounting using larger face plate and handle, IP 40 / IP 66

EG, EGF

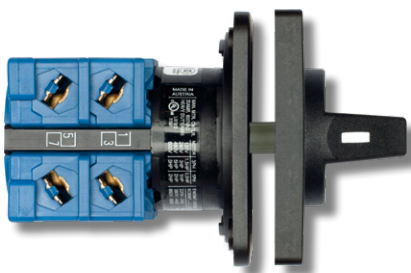

EG – Heavy duty latching panel, degree of protection IP 40.
(Not applicable for DK.. and L...)
4-hole panel mounting using larger size

EGF – Heavy duty latching panel, degree of protection IP 66.
(Not applicable for DK.. and L...)
4-hole panel mounting using larger size

Dimension L on page 185

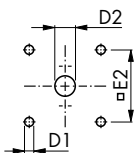
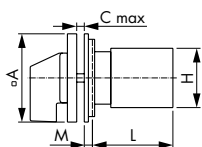

	A11 AD11	A25	CHR10 CHR11 CHR16	DHR10 DHR11	G20/S
A	88	88	64	64	64
C	5,5	5,5	4	4	4
D1	6	6	5	5	5
D2 (EG)	13-17	13-17	10-15	10-15	10-15
D2 (EGF)	26-30	26-30	19-22	19-22	19-22
E2	68	68	48	48	48
H	60	70	46	42	46
M	0,5	0,5	6,7	6,7	6,7

Front panel mounting with heavy duty latching and metal shaft, IP 40 / IP 66

KN2, KN1, KD1, KN2F, KN1F, KD1F

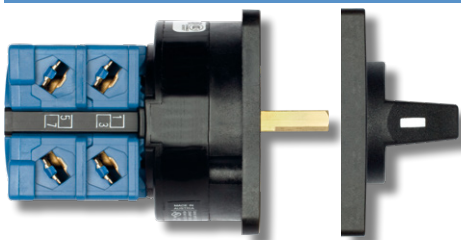

Aluminium shaft, size S0 (48 x 48)
KN2 – Degree of protection IP 40
KN2F – Degree of protection IP 66

Aluminium shaft, size S1 (64 x 64)
KN1 – Degree of protection IP 40
KN1F – Degree of protection IP 66

Square metal shaft, size S1 (64 x 64)
KD1 – Degree of protection IP 40
KD1F – Degree of protection IP 66

Shipment without mounting screws

Shipment without mounting screws

Dimension L on page 185

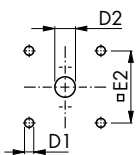
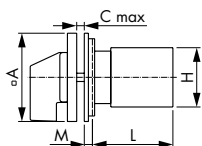

KN2 KN2F	CHR10, CHR11 CHR16	DHR10 DHR11
A	48	48
C	4	4
D1	5	5
D2 (KN2)	8-15	8-15
D2 (KN2F)	15-19	15-19
E2	36	36
H	46	42
M	5,2	5,2

Square shaft KD1

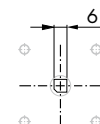

KN1, KN1F KD1, KD1F	A11 AD11	A25	CHR10 CHR11 CHR16	CHR10B CHR11B CHR16B	DHR10 DHR11	DHR10B DHR11B
A	64	64	64	64	64	64
C	4	4	4	4	4	4
D1	5	5	5	5	5	5
D2 (KN1, KD1)	10-15	10-15	10-15	10-15	10-15	10-15
D2 (KN1F, KD1F)	19-22	19-22	10-22	19-22	10-22	19-22
E2	48	48	48	48	48	48
H	60	70	46	56	42	56
M	7	7	4,7	7	4,7	12



Front panel mounting with protective cover

EC., ED..

Protective covers with other mountings: see chapter **OPTIONAL EXTRAS.**



- EC** – 4-hole panel mounting, front IP 40 – rear IP 30 (A., CHR., DHR.)
- ED** – 4-hole panel mounting + additional shaft seal, front IP 65 – rear IP 30 (A., CHR., DHR.)
- EC1** – 4-hole panel mounting, front IP 40 – rear IP 42 (CHR..B, DHR..B)
- ED1** – 4-hole panel mounting + additional shaft seal, front IP 65 – rear IP 42 (CHR..B, DHR..B)
- ED22**– 2-hole panel mounting, front IP 65 – rear IP 42 (CHR10–CHR16)

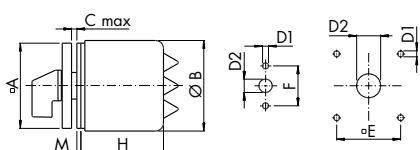

	A11 AD11	ED	CHR10, CHR11 CHR16	ED22	CHR10B CHR16B	EC1 ED1	DHR10 DHR11	DHR11B
	EC	ED	EC ED	ED22	EC ED	EC1 ED1	EC ED	EC ED
A	88	88	64	48	64	64	64	64
B	106	106	68	74	68	74	68	88
C	EC, EC1	5,5	5,5	4	4	4	4	4
C	ED, ED1, ED22	7,5	7,5	2	4	4	2	4
D1		6	6	5	5	5	5	5
D2	EC, EC1	13-17	13-17	8-15		10-15	10-15	8-15
D2	ED, ED1, ED22	28-33	28-33	18-22	11-15	22-25	19-22	18-22
E		68	68	48		48	48	48
F				30				
M	ED, ED22			2	1,5	2		2
1		101	103,5		74,3		72,7	103
2		101	103,5		74,3		72,7	103
3		101	103,5		94,3		92,7	103
4		101	103,5	103	94,3	114,5		127
5	Measure H according to number of stages	139	141,5			127		139,5
6		139	141,5			139,5		164,5
7		139	141,5			164,5		177
8		177	179,5			177		
9		177	179,5					
10		177	179,5					
11		215	217,5					
12		215	217,5					

Terminal covers

M160

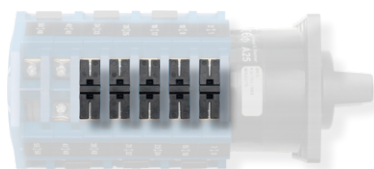

The protective cover prevents accidental contact with current-carrying terminals. (A25, A25C)



SWITCHES FOR SPECIFIC USE AND DC SWITCHES

Base mounting

VE, VE-V, VE1, VE1-V, VF, VF-V, VE22, VE22V, VF22, VF22V

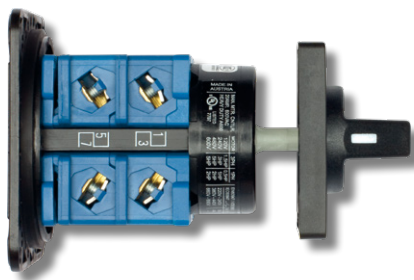

- VE** – Mounting plate and escutcheon plate with 4-hole panel mounting (Not DK.), IP 40
- VE1** – Snap-on base mounting for DIN rail acc. to EN 60715, escutcheon plate with 4-hole panel mounting, IP 40
- VF** – Mounting plate and escutcheon plate with 4-hole panel mounting, Integrated door clutch for enclosures (Only CHR..), IP 65
- VE22** – Mounting plate and escutcheon plate with 2-hole panel mounting (Only for CHR.. and DHR), IP 40
- VF22** – Mounting plate and escutcheon plate with 2-hole panel mounting, Integrated door clutch for enclosures (Only CHR..), IP 65

When ordering with the suffix **...-V**, the switches can be supplied with connection terminals rotated by 90° clockwise.

VE/VE-V

Dimension L on next page

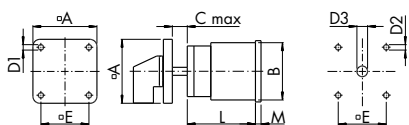

VE1 Size S0, S1

Dimension L on next page

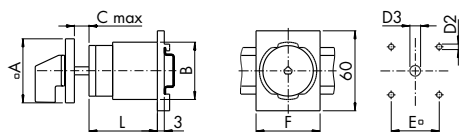

VF/VF-V Size S0 (Only CHR..)

Dimension L on next page

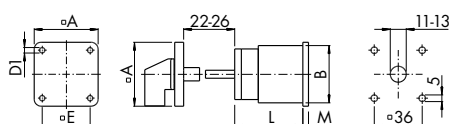

VE22/VE22V Size S0

Dimension L on next page

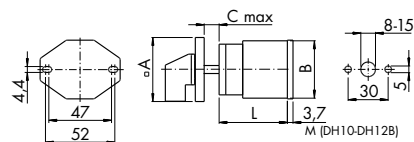

VF22/VF22-V Size S0 (Only CHR..)

Dimension L on next page

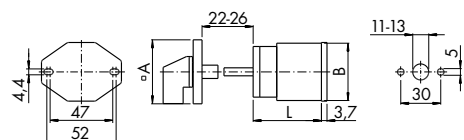

	A11 AD11	A25	CHR10, CHR11 CHR16	G20/S
A	64	64 (88 ¹)	48 (64 ¹)	48 (64 ¹)
B	60	70	46	46
C	13,5	13,5	10,5	10,5
D1	5	5	4,1	4,1
D2	5	5	5	5
D3	10-15	10-15	8-15	8-15
E	48	48 (68 ¹)	36 (48 ¹)	36 (48 ¹)
F	70	70	48	48
M	5	5	5,2	5,2

	DHR10 DHR11	DHR11B
A	48	64
B	42	56
C	10,5	13,5
D1	4,1	4,1
D2	5	5
D3	8-15	10-15
E	36	48
F	48	70
M (VE)	3,2	2,5
M (VE22)	1,9	-
M (VF)	3,2	-
M (VF22)	1,9	-

	L350, L351, L630, L631 L1000, L1250, L1251	L400, L600, L800 L1200, L1600, L2000
A	88	128
B	88	126
C	16	19,3
D1	5,4	7
D2	6	7
D3	13-17	15,5-20
E	68	104
M	27	11,4 ²

¹ Dimensions for rear mounting panel

² L800, L1200 and L1600 = 31,5

Other mountings for Switch type CHR... which are not listed in this chapter, see page from 184.



Snap-on base mounting for DIN rail acc. to EN 60715, IP 40

VE1.

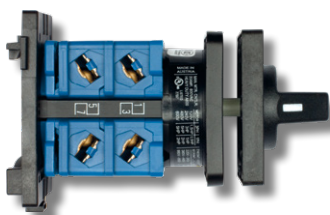

VE1E – Snap-on base mounting for DIN rail acc. to EN 60715. Escutcheon plate is fixed on switch by screws.
(Size S0)
(Size S1: Switch of mounting E + S1.M999/D-0031)

Dimension L refer page below

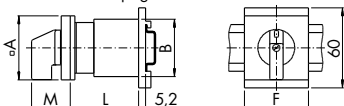

	CHR10, CHR11 CHR16	DHR10 DHR11	G20/S
A	48	48	48
B	46	42	46
F	48	48	48

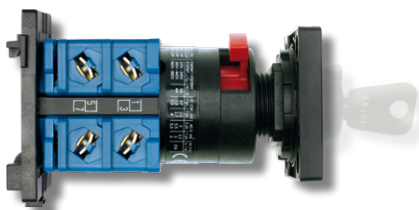

VE1F – Snap-on base mounting for DIN rail acc. to EN 60715. Escutcheon plate is fixed by Single hole mounting, for use with key-lock devices ¹. (Size S0)

Dimension L refer page below

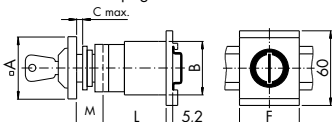

	CHR10, CHR11 CHR16	DHR10 DHR11	G20/S
A	48	48	48
B	46	42	46
F	48	48	48
M	25,2	25,2	25,2

¹ Specify Optional Extras

Position of bolt terminals (Typenumber On request, depending on Switch type and switch program.)

Type 1.1 to 1.4

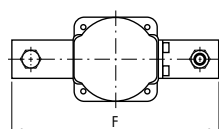

Type 2.1 to 2.4

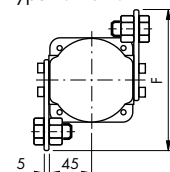

Type 3.1 to 3.3

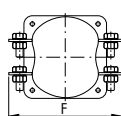

Type 4.1 to 4.2

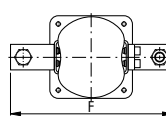

Type 5.1

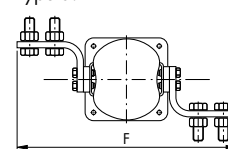

Type	1.1	1.2	1.3	1.4	2.1	2.2	2.3	2.4	3.1	3.2	3.3	4.1	4.2	5.1
Type	L350	L630	L1000		L351	L631			C315 C316	L400 L600	L800 L1200	L1600	L2000	
Dimension F	190	220	230	240	138	148	148	148	150	180	208	256	326	326
Ø terminal screw	M12	M16	M16	M16	M12	M16	M16	M16	M12	M16	M16	M16	2xM16	4xM16
Legth terminal screw	20	30	40	50	20	30	40	50	20	30	40	40	50	50

Dimensions of plug-in connection

DK...-4, DK...-5
(Connection straight 2 x 2,8 mm or 1 x 6,35 mm)

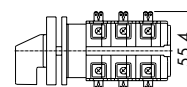

Dimension L

Stages	CA4N CA4N-1	A11 AD11	A25	CHR10 CHR11 CHR16	CHR10B CHR16B	DHR10 DHR11	DHR11B	DK10 DK11	G20	G20S	L350, L351, L630, L631 L1000, L1250, L1251	Please refer types of bolt terminals on this page				
												Double latching mechanism		Double latching mechanism		
												E	ER, VE	E	ER, VE	
1	22,4	42,5	43,5	43,5	48,9	43,5	48,9	61	42	59,3	67,5	94,5	92,6	78,6	110,1	107,7
2	30,4	55,2	56,2	57,5	62,9	61	66,4	78,5	53	70,3	100	127	125,1	117,2	148,7	146,3
3	38,4	67,9	68,9	71,5	76,9	78,5	83,9	96	64	81,3	132,5	159,5	157,6	155,8	187,3	184,9
4	46,4	80,6	81,6	85,5	90,9	96	101,4	113,5	75	92,3	165	192	190,1	194,4	225,9	223,5
5	54,4	93,3	94,3	99,5	104,9	113,5	118,9	131	86	103,3	197,5	224,5	222,6	233	264,5	262,1
6	62,4	106	107	113,5	118,9	131	136,4	148,5	97	114,3	230	257	255,1	271,6	303,1	300,7
7	70,4	118,7	119,7	127,5	132,9	148,5	153,9	166	108	125,3	262,5	289,5	287,6	310,2	341,7	339,3
8	78,4	131,4	132,4	141,5	146,9	166	171,4	183,5	119	136,3	295	322	320,1	348,8	380,3	377,9
9	86,4	144,1	145,1	155,5	160,9	183,5	188,9	201	130	147,3	327,5	354,5	352,6	387,4	418,9	416,5
10	-	156,8	157,8	169,5	174,9	201	206,4	218,5	141	158,3	360	387	385,1	426	457,5	455,1
11	-	169,5	170,5	183,5	188,9	218,5	223,9	236	152	169,3	392,5	419,5	417,6	464,6	496,1	493,7
12	-	182,2	183,2	197,5	202,9	236	241,4	253,5	163	180,3	425	452	450,1	503,2	534,7	532,3

¹ Additional length A11C, AD11C, A25C: 8,2 mm



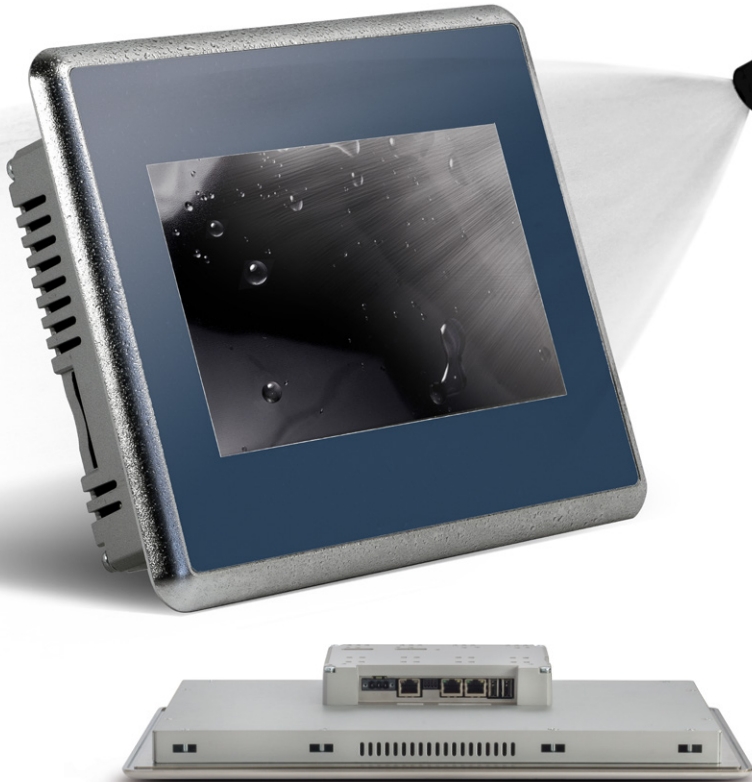

Extensive guarantee despite no protective casing

Easy cleaning

Degree of protection IP69 Rating

Glass strength with polyester coating

High pressure 80°C water resistant

Perfect stainless steel bezel design

Acid chemical resistant

Food compliant gasket

**Front panel and gasket guidelines:
DIN EN1672-2
EHEDG / FDA 21 CFR 177.2006**



food & beverage and pharmaceutical sectors

- Multiple protocols
- OPC UA Server and Client
- CODESYS V3/V2 with Ethernet distributed I/O stacks.
- 3 Ethernet ports with different PHY
- High-resolution displays for multitouch operation
- Wide temperature range
- Expandable with local interfaces and IO's
- Robust design
- Web-Panel

KN-C 700 Hygienic

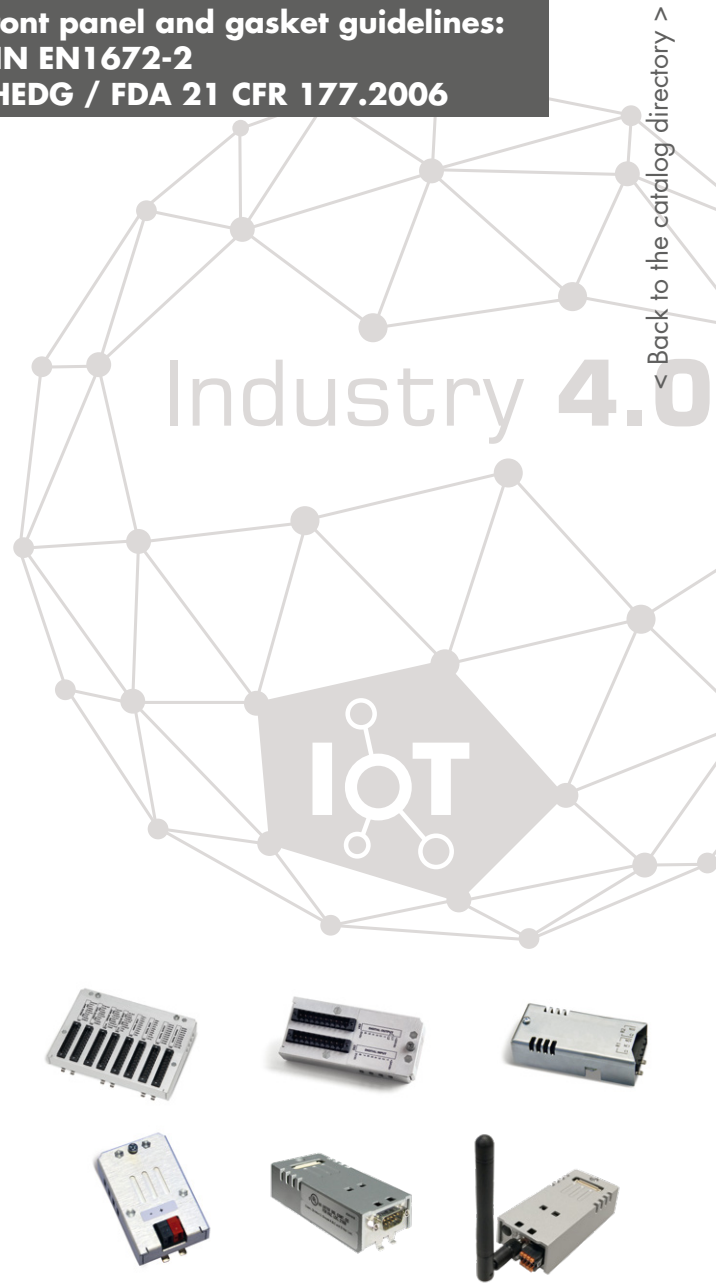

< Back to the catalog directory >

- ▶ Push Buttons
- ▶ Pilot Lights



PUSH BUTTONS AND PILOT LIGHTS

Front elements

Push buttons non-illuminated

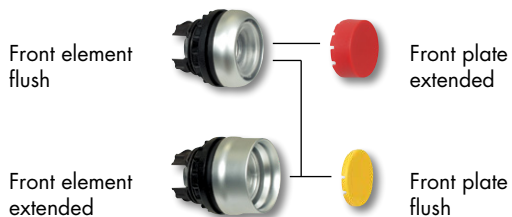

Push buttons illuminated

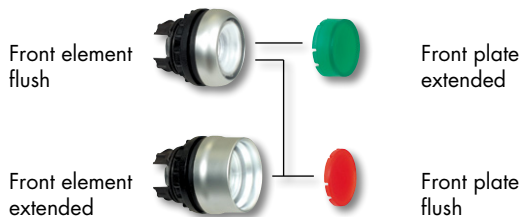

Mushroom push-button

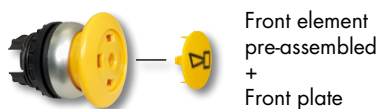

Rotary switches



Double-push buttons

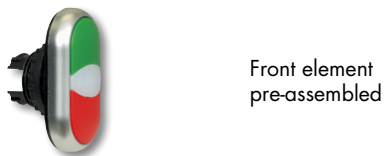

Emergency-stop/OFF push buttons



Pilot lights

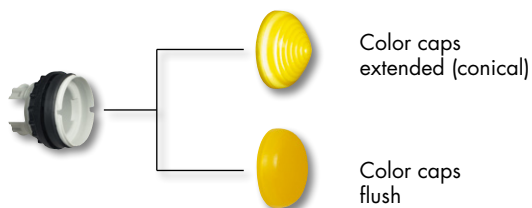

Solid pilot lights



Potentiometer



Acoustic device



Contact blocks and LED pilot light assemblies

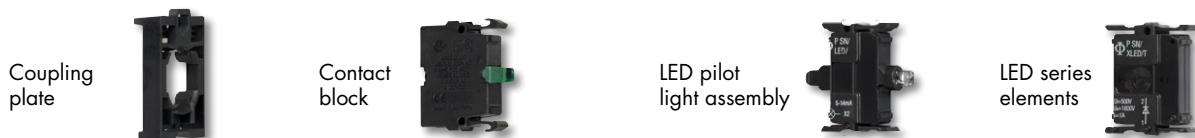

CHAPTER OVERVIEW

Pre-assembled units

Push buttons flush, pilot lights flush, solid pilot lights	190
Rotary switches, double-push buttons, potentiometer, compact Acoustic device	190
Emergency-stop/OFF push buttons, emergency-stop/OFF push buttons enclosed	191

Front elements

Push buttons non-illuminated – illuminated, pilot lights, rotary switches	192
Mushroom push buttons, emergency-stop/OFF push buttons	193
Double-push buttons, 4-position-push buttons, rotary switches key operated, reset units, blank cover	193

Front element components

Push buttons, non-illuminated–illuminated, pilot lights	194
Coupling plates, lamps and contact blocks	
Coupling plates, LED pilot light assemblies, LED series elements, contact blocks	195
Enclosure	
Plastic enclosures	196
Front plates and color caps	
Inscriptions	200





Accessory

Legend carrier, Face plate, legend plate	197
Face plate, protective shroud, DIN rail adapter	198
Bulb extractor, nut key, protective shroud, fixation nut, spare key, rod link, coding pieces, lamps	199

Technical data

202

Adapted to your special needs

Front element	Legend plate	Fixation nut	Coupling plate	Contact blocks and LED pilot light assemblies
 <ul style="list-style-type: none"> > Ergonomical design , Front rings metallic colored or black > Illuminated elements OFFER excellent brightest and contrast in all light conditions > Pilot lights with perfect light due to special lenses > Any inscription, abrasion-resistant by laser > Latched push buttons and rotary switches are programmable for spring return function > Mushroom push buttons with large surface > High protection and food resistance: push buttons und pilot lights IP 67 /IP 69K, double-push buttons und rotary switches IP 66 > Available with protection caps for special operating 	 <ul style="list-style-type: none"> > For front elements and double-push buttons > With legend inserts > Available with lasered or engraved inscriptions 	 <ul style="list-style-type: none"> > Included in delivery of front elements > Nut key for fixation nuts as accessory available 	 <ul style="list-style-type: none"> > For contact blocks and LED pilot light assemblies > Max. 3 elements per contact level > Up to 6 contacts on 2 contact levels are possible 	 <ul style="list-style-type: none"> Contact blocks <ul style="list-style-type: none"> > Available as N/C and N/O > High switching capacity, both in AC-15- and DC-13-operation 2 levels possible LED pilot light assemblies <ul style="list-style-type: none"> > Available in green, red and white > Long life (100 000 running hours) by especially low power consumption and vibration resistance > With only 2 voltage ranges the worldwide common applications are fulfilled > LED series elements for decoupled funtion control are available

PUSH BUTTONS AND PILOT LIGHTS

Pre-assembled units

Push buttons flush, IP 67/IP 69K

non-illuminated

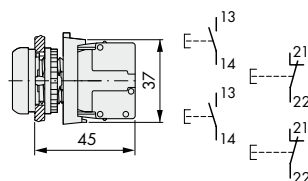
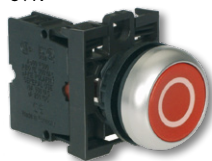

Color	Order number
	P.SN-WD0001
	P.SN-WD0002
	P.SN/D/G/X1-K10
	P.SN/D/R/X0-K01

Pilot lights flush, IP 67/IP 69K

with LED element

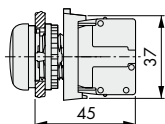
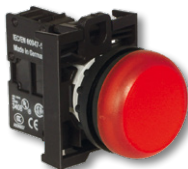

12 V-30 V AC/DC
12 V-30 V AC/DC
85 V-264 V AC
85 V-264 V AC

	P.SN-WD0003
	P.SN-WD0004
	P.SN-WD0005
	P.SN-WD0006

Solid pilot lights, IP 67/IP 69K

for bulbs, neon bulbs and LEDs up to 2,4 W with BA 9s lamp socket (without bulb)

flush

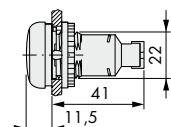

	P.SN/LC/G
	P.SN/LC/R
	P.SN/LC/Y
	P.SN/LC/B
	P.SN/LC/W

extended (conical)

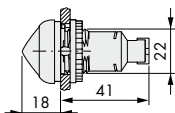

	P.SN/LCH/G
	P.SN/LCH/R
	P.SN/LCH/Y
	P.SN/LCH/B
	P.SN/LCH/W

Rotary switches, IP 66

non-illuminated, latched (changeable by coding pieces to spring return function)

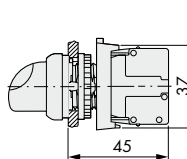

2 positions

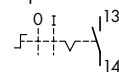

P.SN/WRK-K10

3 positions

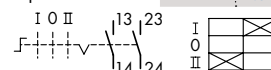

P.SN/WRK3-K20

Double-push buttons, IP 66

with LED element 85–264 V AC color cap white (opaque)

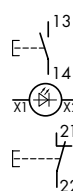
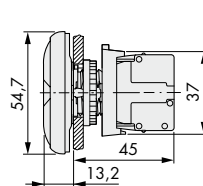

P.SN/DD/GR/X1-X0-K11

Potentiometer, IP 66

3 separate screw terminals
P max. = 0,5 W

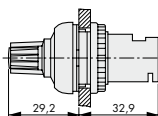

kΩ	Order number
1	P.SN/R1K
4,7	P.SN/R4K7
10	P.SN/R10K

Compact acoustic device, IP 40

without buzzer, BA 9s lamp socket



P.SN/AMC

Buzzer for acoustic device

Continuous tone, 18–30 V AC/DC,
83 dB/10 cm, 18–30 mA,
plus terminal at X1, f = 2300 Hz



P.SN/XAM



Pre-assembled units

Emergency-stop/OFF push buttons, IP 67 / IP 69K

Fool-proof acc. to ISO 13850/EN 418, reset by pulling, complement max.: 4 contact blocks

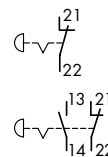
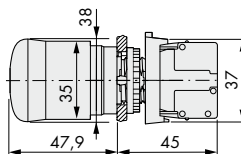

Order number

P.SN/PVK01

P.SN/PVK11

Emergency-stop/OFF push buttons, IP 67 / IP 69K

Reset by key operation, 1 key, locking MS1

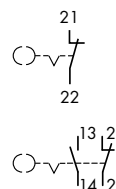
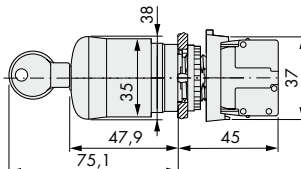

P.SN/PVS-K01

P.SN/PVS-K11

Emergency-stop/OFF push buttons enclosed, IP 67 / IP 69K

Enclosure yellow-black, reset by pulling, complement max.: 3 contact blocks

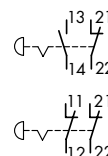

P.SN/PV-KC11-Y

P.SN/PV-KC02-Y

Emergency-stop/OFF push buttons enclosed, IP 67 / IP 69K

Foot and palm switch, enclosure yellow-black, reset by pulling, complement max.: 3 contact blocks

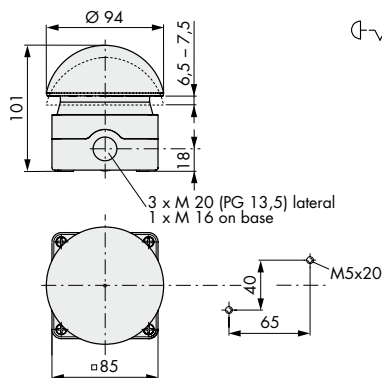

P.FT/R-V-KC01-Y



PUSH BUTTONS AND PILOT LIGHTS

Front elements

Push buttons non-illuminated

IP 67 / IP 69K

flush

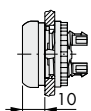

extended

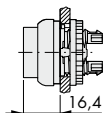

Color	Order number	
	spring return, flush	spring return, extended:
●	P.SN/D/S	P.SN/DH/S
○	P.SN/D/W	P.SN/DH/W
●	P.SN/D/R	P.SN/DH/R
●	P.SN/D/G	P.SN/DH/G
●	P.SN/D/Y	P.SN/DH/Y
●	P.SN/D/B	P.SN/DH/B
○	P.SN/D/R/X0	P.SN/DH/R/X0
○	P.SN/D/G/X1	P.SN/DH/G/X1
○		P.SN/DH/W/X1
○		P.SN/DH/S/X0

Push buttons illuminated

IP 67 / IP 69K

flush

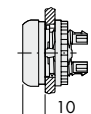

extended

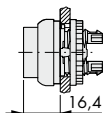

	spring return, flush	latched, flush	spring return, extended:
○	P.SN/DL/W	P.SN/DRL/W	P.SN/DLH/W
●	P.SN/DL/R	P.SN/DRL/R	P.SN/DLH/R
●	P.SN/DL/G	P.SN/DRL/G	P.SN/DLH/G
●	P.SN/DL/Y	P.SN/DRL/Y	P.SN/DLH/Y
●	P.SN/DL/B	P.SN/DRL/B	P.SN/DLH/B
○	P.SN/DL/R/X0		
○	P.SN/DL/G/X1		

Pilot lights

IP 67 / IP 69K

flush

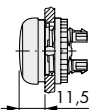

extended (conical)

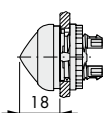

	flush	extended (conical)
○	P.SN/L/W	P.SN/LH/W
●	P.SN/L/R	P.SN/LH/R
●	P.SN/L/G	P.SN/LH/G
●	P.SN/L/Y	P.SN/LH/Y
●	P.SN/L/B	P.SN/LH/B

Rotary switches

IP 66

non-illuminated

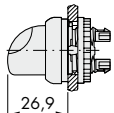

	↗	↘	↕	↕
	2 spring return positions	2 latching positions ¹	3 spring return positions	3 latching positions ¹
	P.SN/WK	P.SN/WRK	P.SN/WK3	P.SN/WRK3

Rotary switches

IP 66

illuminated

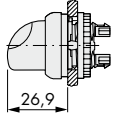

	2 spring return positions	2 latching positions ¹	3 spring return positions	3 latching positions ¹
○	P.SN/WLK/W	P.SN/WRLK/W	P.SN/WLK3/W	P.SN/WRLK3/W
●	P.SN/WLK/R	P.SN/WRLK/R	P.SN/WLK3/R	P.SN/WRLK3/R
●	P.SN/WLK/G	P.SN/WRLK/G	P.SN/WLK3/G	P.SN/WRLK3/G
●	P.SN/WLK/Y	P.SN/WRLK/Y	P.SN/WLK3/Y	P.SN/WRLK3/Y
●	P.SN/WLK/B	P.SN/WRLK/B	P.SN/WLK3/B	P.SN/WRLK3/B

¹ Changeable by coding pieces from latching (60° switching angle) to spring return function (40° switching angle).



Front elements

Mushroom push buttons, IP 67 / IP 69K

without front plate

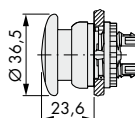

front plate for mushroom push buttons



Color	Order number	
	spring return	latched
●	P.SN/DP/S/X	P.SN/DRP/S/X
●	P.SN/DP/R/X	P.SN/DRP/R/X
●	P.SN/DP/G/X	P.SN/DRP/G/X
●	P.SN/DP/Y/X	P.SN/DRP/Y/X
○	P.SN/XDP/W	
●	P.SN/XDP/S	
●	P.SN/XDP/R	
●	P.SN/XDP/G	
●	P.SN/XDP/Y	

Inscripted front plates refer page 201

Emergency-stop/OFF push buttons

IP 67 / IP 69K (turn), IP 66 / IP 69K (pull)
fool-proof acc. to ISO 13 850 / EN418

non-illuminated

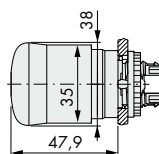

illuminated



●	P.SN/PV (reset by pulling)
●	P.SN/PVT (reset by turning)

Reset by key operation,
1 key, locking MS1

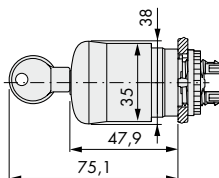

●	P.SN/PVI (reset by pulling)
●	P.SN/PVIT (reset by turning)

●	P.SN/PVS
---	----------

Double-push buttons, IP 66

Color cap white (opaque)

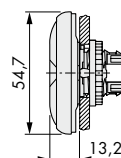

■	P.SN/DDI/GR
■	P.SN/DDI/GR/X1-X0
START STOP	P.SN/DDI/GR/GB1-GB0
■	P.SN/DDI/S/X7-X7

4-position-push buttons, IP 66

4 contacts in combination
with coupling plate P.SN/A4

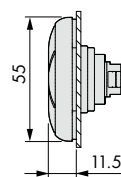

Color	Order number
black	P.SN/D4/S/X7

Rotary switches key operated, IP 66

switching angle 60°, latched,
changeable by coding pieces
to spring return function (40°
switching angle)

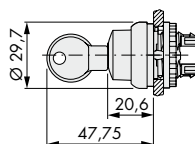

1 key, locking MS1

	2 positions	3 positions
The key is removable in all switch positions	P.SN/WRS	P.SN/WRS3
The key is removable only in O-position.	P.SN/WRS/A1	P.SN/WRS3/A1

Reset units, IP 67 / IP 69K

non-illuminated
blue



Inscription	Order number
RESET	P.SN/DZ/B/GB14
R	P.SN/DZ/B/X6

Blank cover, IP 67 / IP 69K

for surplus control positions



Color	Order number
grey	P.SN/B
black	P.SB/B

PUSH BUTTONS AND PILOT LIGHTS

Front element components

Push buttons non-illuminated, IP 67 / IP 69K, without front plate

with flush Front ring

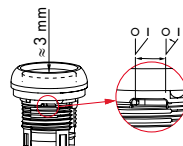
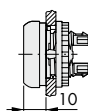

Changeable by coding pieces to spring return function

Order number	
spring return	latched
P.SN/D/X	P.SN/DR/X

spring return
P.SN/DG/X

with extended Front ring

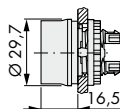

Front plates for push buttons non-illuminated

flush



extended



Color	Order number
Black	P.SN/XD/S
White	P.SN/XD/W
Red	P.SN/XD/R
Green	P.SN/XD/G
Yellow	P.SN/XD/Y
Blue	P.SN/XD/B
Black	P.SN/XDH/S
White	P.SN/XDH/W
Red	P.SN/XDH/R
Green	P.SN/XDH/G
Yellow	P.SN/XDH/Y
Blue	P.SN/XDH/B

Inscripted front plates refer page 200

Push buttons illuminated, IP 67 / IP 69K, without front plate

with flush Front ring

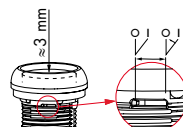
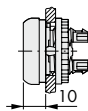

Changeable by coding pieces to spring return function

Order number	
spring return	latched
P.SN/DL/X	P.SN/DRL/X

with extended Front ring

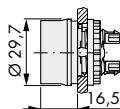

spring return
P.SN/DGL/X

Front plates für Push buttons illuminated

flush



extended



Color	Order number
White	P.SN/XDL/W
Red	P.SN/XDL/R
Green	P.SN/XDL/G
Yellow	P.SN/XDL/Y
Blue	P.SN/XDL/B
White	P.SN/XDLH/W
Red	P.SN/XDLH/R
Green	P.SN/XDLH/G
Yellow	P.SN/XDLH/Y
Blue	P.SN/XDLH/B

Inscripted front plates refer page 200

Pilot lights

IP 67 / IP 69K, flush, without color cap

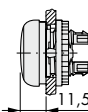

P.SN/L/X

Color caps for pilot lights



White	P.SN/XL/W
Red	P.SN/XL/R
Green	P.SN/XL/G
Yellow	P.SN/XL/Y
Blue	P.SN/XL/B

Inscripted front plates refer page 201



Coupling plates, lamps and contact blocks

Coupling plate

for 3 contact or lamp blocks

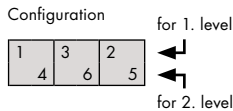

Order number
P.SN/A

or 4 contact blocks (only with 4 position push-button)

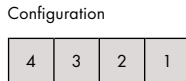
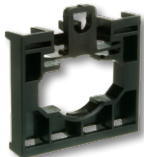

P.SN/A4

Contact blocks

front mounting

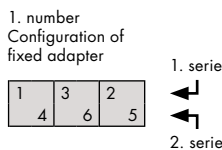

2. number of contact element

3	P.SN/K10
---	----------

1	P.SN/K01
---	----------

Safety function by direct opening action acc. to IEC/EN 60947-5-1

for Plastic enclosures

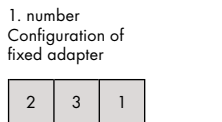

3	P.SN/KC10
---	-----------

1	P.SN/KC01
---	-----------

Safety function by direct opening action acc. to IEC/EN 60947-5-1

LED lamp element

front mounting



for Plastic enclosures



	Color	Order number
12 V-30 V AC/DC	White	P.SN/LED/W
	Red	P.SN/LED/R
	Green	P.SN/LED/G
	Blue	P.SN/LED/B
85 V-264 V AC	White	P.SN/LED230/W
	Red	P.SN/LED230/R
	Green	P.SN/LED230/G
	Blue	P.SN/LED230/B
12 V-30 V AC/DC	White	P.SN/LEDC/W
	Red	P.SN/LEDC/R
	Green	P.SN/LEDC/G
	Blue	P.SN/LEDC/B
85 V-264 V AC	White	P.SN/LEDC230/W
	Red	P.SN/LEDC230/R
	Green	P.SN/LEDC230/G
	Blue	P.SN/LEDC230/B



LED serie element

front and base mounting



Resistor element for 42 V-60 V AC/DC for pilot light assemblies 12 V-30 V AC/DC	P.SN/XLED60
LED test elements for decoupled operational test for connecting to:	
12 V-30 V AC/DC	P.SN/XLED/T
85 V-264 V AC/DC	P.SN/XLED230/T

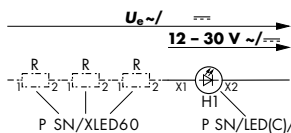

P.SN/XLED60 : 1 x 2 x 3 x 4 x 5 x 6 x 7 x
 $U_e \leq$: 60 V : 90 V : 120 V : 150 V : 180 V : 210 V : 240 V

P.SN/XLED/T

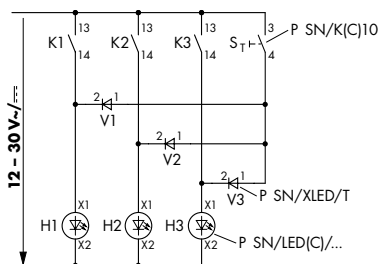

P.SN/XLED/T

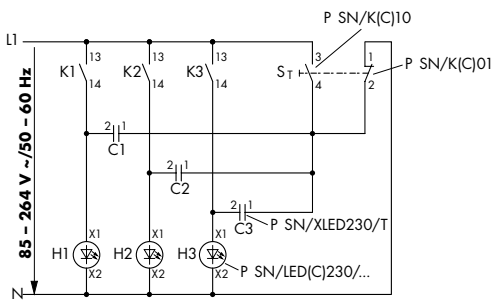

P.SN/XLED230/T

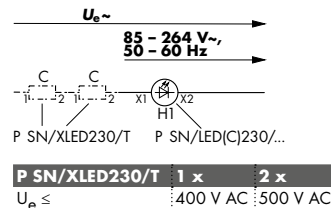

PUSH BUTTONS AND PILOT LIGHTS

Plastic enclosures, IP 67 / IP 69 (totally insulated, lid screws made of stainless steel)

yellow / black

one control position
complement max.: 3 contact blocks



Order number

P.SN/IY1

grey / black

one control position
complement max.: 3 contact blocks



P.SN/11

grey / black

2–6 control positions
complement max.:
3 contact blocks per control position



Control positions	Order number
2	P.SN/12
3	P.SN/13
4	P.SN/14
6*	P.SN/16

*IP 66

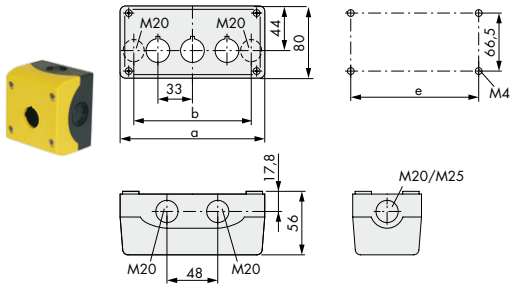

Type	a	b	e	Bushes		
P.SN/IY1	72	42,6	58,5	2xM16	3xM20	2xM25
P.SN/11	72	42,6	58,5	2xM16	3xM20	2xM25
P.SN/12	120	85,6	106,5	2xM20	3xM20	2xM25
P.SN/13	153	118,6	139,5	2xM20	2xM25	4xM20
P.SN/14	186	151,6	172,5	2xM20	2xM25	4xM20
P.SN/16	252	217,6	238,5	2xM20	2xM25	4xM20

Notice:

Enclosure is suitable for Mounting of Switch type CA4 with 1 or 2 contacts or CA4N with max. 4 contacts of mounting FS1 and FS2.



Accessory

Legend carrier, IP 66 (without plate)

for push buttons

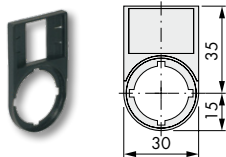

Order number
P.SB/ST/X

for double-push buttons

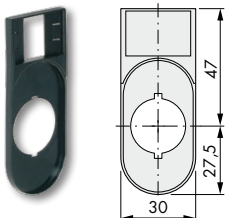

P.SB/STDD/X

Face plates

for legend carrier



P.SN/XST

Legend plates, IP 66 (complete standard unit)

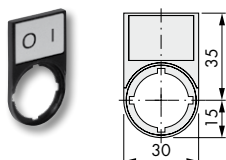

Inscription	Order number	Inscription	Order number
○	P.SB/ST/X88	FAULT	P.SB/ST/GB8
○	P.SB/ST/X89	Betrieb	P.SB/ST/D7
○	P.SB/ST/X93	RUN	P.SB/ST/GB7
STOP	P.SB/ST/GB0	HAND AUTO	P.SB/ST/D11
START	P.SB/ST/GB1	MAN. AUTO	P.SB/ST/GB11
AUS	P.SB/ST/D5	Aus Ein	P.SB/ST/D10
OFF	P.SB/ST/GB5	OFF ON	P.SB/ST/GB10
EIN	P.SB/ST/D6	HAND 0 AUTO	P.SB/ST/D12
ON	P.SB/ST/GB6	MAN. 0 AUTO	P.SB/ST/GB12
Störung	P.SB/ST/D8		

Mounting drilling with slot

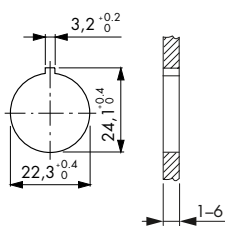

Grid dimension acc. to IEC/EN 60947

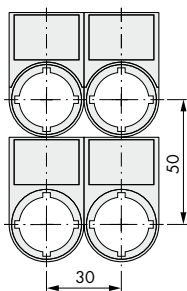

Grid dimension for different combinations

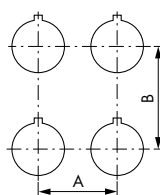

Type	A ≥	B ≥
P.SN/... (IEC/EN 60947)	30	50
P.SN/...	30	40
P.SN/D... + P.SN/T/D	33	40
P.SN/D(R)P...	38	40
P.SN/PV...	38	40
P.SN/PV(L...)(S...) + P.SN/D...	33	40
P.SN/DDL...	30	55
P.SN/DDL... + P.SN/T/DD	33	58
P.SB/ST 30	30	50
P.SB/STDD	30	75
P.SN/XAK...	90	90
P.SN/XZK...	33	52
P.SN/XBK...	60	60
P.SN/XYK...	50	50

Grid dimension for P.SN/DD...

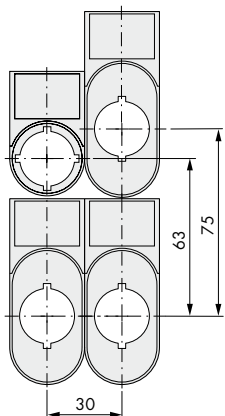

Grid dimension for P.SN/DD... with protection cap P.SN/T/DD

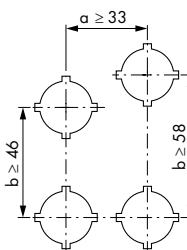

Protection cap and protective shroud cannot be combined with legend carrier

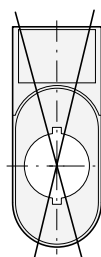

Protection cap cannot be combined with legend carrier



PUSH BUTTONS AND PILOT LIGHTS

Accessory

Emergency-stop plates IP 66

rectangular

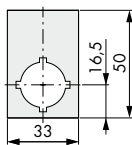

Inscription	Order number
NOT-HALT	P.SN/XZK1/D99
NOT-AUS	P.SN/XZK/D99
EMERGENCY-STOP	P.SN/XZK/GB99

square, quadrilingual

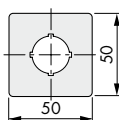

Inscription	Order number
NOT-HALT	P.SN/XYK1 I
NOT-AUS	P.SN/XYK1

round, quadrilingual

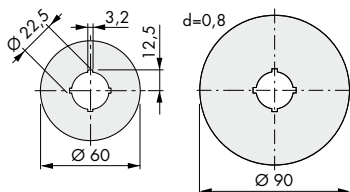

Ø	Inscription	Order number
60	NOT-HALT	P.SN/XBK1 I
90	NOT-HALT	P.SN/XAK1 I
60	NOT-AUS	P.SN/XBK1
90	NOT-AUS	P.SN/XAK1

Protective shrouds

IP 66

- protection against accidental operation
- for push buttons and rotary switches
- cannot be combined with legend plates

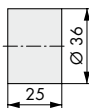

Order number
P.SN/XGWK

IP 65

- yellow, for Emergency-stop/ OFF push buttons
- cannot be combined with legend plates

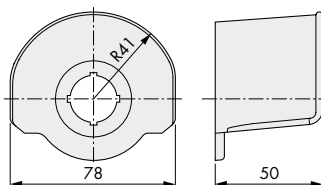

Order number
P.SN/XGPV

DIN rail adapter

for DIN rails acc. to EN 60715
for front mounted units

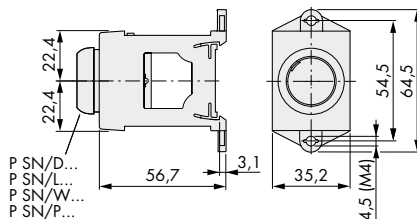
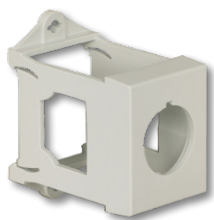

Order number
P.SN/IVS



Accessory

Bulb extractor



Order number

P.SN/LGL

Nut key

for push buttons,
pilot lights
and rotary switches



P.SN/MS

Protection caps

IP 67, transparent, for aggravating environments
(not in food areas), cannot be combined with legend plates

for push buttons, flush
and pilot lights, flush

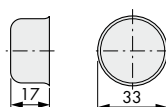

P.SN/T/D

for double-push buttons

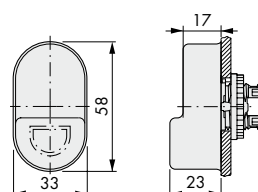

P.SN/T/DD

for rotary switches key operated
prevents dirt and dust from getting
into the keyhole (not in food areas)

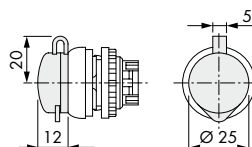

P.SN/XWS



Fixation nut

for push buttons, pilot lights and rotary switches



P.SN/GR

Spare key

for locking MS1



P.SN/ES/MS1

Rod link

for operating the middle contact block
of non-illuminated rotary switches with 3 positions



For the middle
contact block of
rotary switches
with 2 or 3
positions

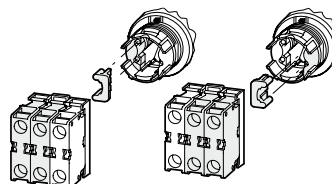

P.SN/XW

Coding pieces

for rotary switches to convert the latched
function into spring return function
(1 kit = 2 pieces)



Rotary switches

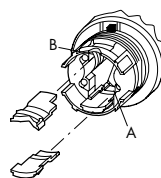

P.SN/XC/Y in B

P.SN/XC/Y



P.SN/XC/Y in A and B

Key is removable
in spring return position

PUSH BUTTONS AND PILOT LIGHTS

Front plates for push buttons

Color	Inscription	Meaning	non-illuminated		illuminated		
			flush	extended	flush	extended	
●	Zu		P.SN/XD/S/D2	P.SN/XDH/S/D2			
	Auf		P.SN/XD/S/D3	P.SN/XDH/S/D3			
	Ab		P.SN/XD/S/D4	P.SN/XDH/S/D4			
○	Zu				P.SN/XDL/W/D2	P.SN/XDLH/W/D2	
	Auf				P.SN/XDL/W/D3	P.SN/XDLH/W/D3	
	Ab				P.SN/XDL/W/D4	P.SN/XDLH/W/D4	
●	Aus		P.SN/XD/R/D5	P.SN/XDH/R/D5	P.SN/XDL/R/D5	P.SN/XDLH/R/D5	
	Ein				P.SN/XDL/W/D6	P.SN/XDLH/W/D6	
○	Ein		P.SN/XD/S/D6	P.SN/XDH/S/D6			
●	Entsperren		P.SN/XD/B/D14	P.SN/XDH/B/D14	P.SN/XDL/B/D14	P.SN/XDLH/B/D14	
	Vorwärts				P.SN/XDL/W/D15	P.SN/XDLH/W/D15	
○	Rückwärts				P.SN/XDL/W/D16	P.SN/XDLH/W/D16	
	Heben				P.SN/XDL/W/D17	P.SN/XDLH/W/D17	
	Senken				P.SN/XDL/W/D18	P.SN/XDLH/W/D18	
	Vorwärts		P.SN/XD/S/D15	P.SN/XDH/S/D15			
●	Rückwärts		P.SN/XD/S/D16	P.SN/XDH/S/D16			
	Heben		P.SN/XD/S/D17	P.SN/XDH/S/D17			
	Senken		P.SN/XD/S/D18	P.SN/XDH/S/D18			
	STOP		P.SN/XD/R/GB0	P.SN/XDH/R/GB0	P.SN/XDL/R/GB0	P.SN/XDLH/R/GB0	
○	STOP				P.SN/XDL/W/GB0	P.SN/XDLH/W/GB0	
●	STOP		P.SN/XD/S/GB0	P.SN/XDH/S/GB0			
●	START		P.SN/XD/G/GB1	P.SN/XDH/G/GB1	P.SN/XDL/G/GB1	P.SN/XDLH/G/GB1	
	START				P.SN/XDL/W/GB1	P.SN/XDLH/W/GB1	
○	CLOSE				P.SN/XDL/W/GB2	P.SN/XDLH/W/GB2	
	UP				P.SN/XDL/W/GB3	P.SN/XDLH/W/GB3	
	DOWN				P.SN/XDL/W/GB4	P.SN/XDLH/W/GB4	
	START		P.SN/XD/W/GB1	P.SN/XDH/W/GB1			
●	CLOSE		P.SN/XD/S/GB2	P.SN/XDH/S/GB2			
	UP		P.SN/XD/S/GB3	P.SN/XDH/S/GB3			
	DOWN		P.SN/XD/S/GB4	P.SN/XDH/S/GB4			
	OFF		P.SN/XD/R/GB5	P.SN/XDH/R/GB5	P.SN/XDL/R/GB5	P.SN/XDLH/R/GB5	
○	ON				P.SN/XDL/W/GB6	P.SN/XDLH/W/GB6	
○	TEST				P.SN/XDL/W/GB9	P.SN/XDLH/W/GB9	
	ON		P.SN/XD/S/GB6	P.SN/XDH/S/GB6			
●	TEST		P.SN/XD/S/GB9	P.SN/XDH/S/GB9			
●	RESET		P.SN/XD/B/GB14	P.SN/XDH/B/GB14	P.SN/XDL/B/GB14	P.SN/XDLH/B/GB14	
	FORWARD				P.SN/XDL/W/GB15	P.SN/XDLH/W/GB15	
○	REVERSE				P.SN/XDL/W/GB16	P.SN/XDLH/W/GB16	
	RAISE				P.SN/XDL/W/GB17	P.SN/XDLH/W/GB17	
	LOWER				P.SN/XDL/W/GB18	P.SN/XDLH/W/GB18	
	FORWARD		P.SN/XD/S/GB15	P.SN/XDH/S/GB15			
●	REVERSE		P.SN/XD/S/GB16	P.SN/XDH/S/GB16			
	RAISE		P.SN/XD/S/GB17	P.SN/XDH/S/GB17			
	LOWER		P.SN/XD/S/GB18	P.SN/XDH/S/GB18			
	STOP	○	Stopp	P.SN/XD/R/X0	P.SN/XDH/R/X0	P.SN/XDL/R/X0	P.SN/XDLH/R/X0
○	○	Stopp			P.SN/XDL/W/X0	P.SN/XDLH/W/X0	
●	○	Stopp	P.SN/XD/S/X0	P.SN/XDH/S/X0			
●	Start	I	P.SN/XD/G/X1	P.SN/XDH/G/X1	P.SN/XDL/G/X1	P.SN/XDLH/G/X1	
	Start	I			P.SN/XDL/W/X1	P.SN/XDLH/W/X1	
○	Start	I	P.SN/XD/S/X1	P.SN/XDH/S/X1			
	Start	I	P.SN/XD/W/X1	P.SN/XDH/W/X1			
●	Start	II	P.SN/XD/G/X2	P.SN/XDH/G/X2	P.SN/XDL/G/X2	P.SN/XDLH/G/X2	
	Start	II			P.SN/XDL/W/X2	P.SN/XDLH/W/X2	
○	Start	II	P.SN/XD/S/X2	P.SN/XDH/S/X2			
	Increase	+			P.SN/XDL/W/X4	P.SN/XDLH/W/X4	
○	Decrease	-			P.SN/XDL/W/X5	P.SN/XDLH/W/X5	
	Start	II	P.SN/XD/S/X2	P.SN/XDH/S/X2			
●	Increase	+	P.SN/XD/S/X4	P.SN/XDH/S/X4			
	Decrease	-	P.SN/XD/S/X5	P.SN/XDH/S/X5			
●	Reset	R	P.SN/XD/S/X6	P.SN/XDH/S/X6	P.SN/XDL/B/X6	P.SN/XDLH/B/X6	
	Guide motion	↔	P.SN/XD/S/X7	P.SN/XDH/S/X7			
●	Guide motion	↔	P.SN/XD/S/X8	P.SN/XDH/S/X8			
	Hand-control	↔	P.SN/XD/S/X9	P.SN/XDH/S/X9			
	Automatic cycle	Ⓞ	P.SN/XD/S/X10	P.SN/XDH/S/X10			
	Inching	Ⓞ	P.SN/XD/S/X11	P.SN/XDH/S/X11			
	Disengaging	Ⓞ	P.SN/XD/S/X12	P.SN/XDH/S/X12			
	Unlocking	Ⓞ	P.SN/XD/S/X13	P.SN/XDH/S/X13			
	Tighten	Ⓞ	P.SN/XD/S/X14	P.SN/XDH/S/X14			
	Release	Ⓞ	P.SN/XD/S/X15	P.SN/XDH/S/X15			
	Liquid	Ⓞ	P.SN/XD/S/X16	P.SN/XDH/S/X16			
	Horn	Ⓞ	P.SN/XD/S/X17	P.SN/XDH/S/X17			
	○	Guide motion	↔			P.SN/XDL/W/X7	P.SN/XDLH/W/X7
		Guide motion	↔			P.SN/XDL/W/X8	P.SN/XDLH/W/X8
		Hand-control	↔			P.SN/XDL/W/X9	P.SN/XDLH/W/X9
		Automatic cycle	Ⓞ			P.SN/XDL/W/X10	P.SN/XDLH/W/X10
		Inching	Ⓞ			P.SN/XDL/W/X11	P.SN/XDLH/W/X11
		Disengaging	Ⓞ			P.SN/XDL/W/X12	P.SN/XDLH/W/X12
		Unlocking	Ⓞ			P.SN/XDL/W/X13	P.SN/XDLH/W/X13
Tighten		Ⓞ			P.SN/XDL/W/X14	P.SN/XDLH/W/X14	
Release		Ⓞ			P.SN/XDL/W/X15	P.SN/XDLH/W/X15	
Liquid		Ⓞ			P.SN/XDL/W/X16	P.SN/XDLH/W/X16	
Horn	Ⓞ			P.SN/XDL/W/X17	P.SN/XDLH/W/X17		



Front elements



Front plates for mushroom push buttons				Color caps for pilot lights				
Color	Inscription	Meaning	non-illuminated	Color	Inscription	Meaning	transparent	
●	Zu		P.SN/XDP/S/D2	○	Zu		P.SN/XL/W/D2	
	Auf		P.SN/XDP/S/D3		Auf		P.SN/XL/W/D3	
	Ab		P.SN/XDP/S/D4		Ab		P.SN/XL/W/D4	
●	Aus		P.SN/XDP/R/D5	●	Aus		P.SN/XL/R/D5	
	Ein		P.SN/XDP/S/D6		○	Ein		P.SN/XL/W/D6
	Vorwärts		P.SN/XDP/S/D15			Vorwärts		P.SN/XL/W/D15
	Rückwärts		P.SN/XDP/S/D16			Rückwärts		P.SN/XL/W/D16
	Heben		P.SN/XDP/S/D17			Heben		P.SN/XL/W/D17
Senken		P.SN/XDP/S/D18	Senken			P.SN/XL/W/D18		
●	STOP		P.SN/XDP/R/GB0	●	STOP		P.SN/XL/R/GB0	
●	STOP		P.SN/XDP/S/GB0	○	STOP		P.SN/XL/W/GB0	
●	START		P.SN/XDP/G/GB1	●	START		P.SN/XL/G/GB1	
○	START		P.SN/XDP/W/GB1	○	START		P.SN/XL/W/GB1	
●	CLOSE		P.SN/XDP/S/GB2	○	CLOSE		P.SN/XL/W/GB2	
	UP		P.SN/XDP/S/GB3		UP		P.SN/XL/W/GB3	
	DOWN		P.SN/XDP/S/GB4		DOWN		P.SN/XL/W/GB4	
●	OFF		P.SN/XDP/R/GB5	●	OFF		P.SN/XL/R/GB5	
●	ON		P.SN/XDP/S/GB6	○	ON		P.SN/XL/W/GB6	
	TEST		P.SN/XDP/S/GB9		TEST		P.SN/XL/W/GB9	
	FORWARD		P.SN/XDP/S/GB15		FORWARD		P.SN/XL/W/GB15	
	REVERSE		P.SN/XDP/S/GB16		REVERSE		P.SN/XL/W/GB16	
	RAISE		P.SN/XDP/S/GB17		RAISE		P.SN/XL/W/GB17	
	LOWER		P.SN/XDP/S/GB18		LOWER		P.SN/XL/W/GB18	
●	○	Stopp	P.SN/XDP/R/X0	●	○	Stopp	P.SN/XL/R/X0	
●	○	Stopp	P.SN/XDP/S/X0	○	○	Stopp	P.SN/XL/W/X0	
●		Start	P.SN/XDP/G/X1	●		Start	P.SN/XL/G/X1	
○		Start	P.SN/XDP/S/X1	○		Start	P.SN/XL/W/X1	
○		Start	P.SN/XDP/W/X1	○		Start	P.SN/XL/W/X1	
●		Start	P.SN/XDP/G/X2	○		Start	P.SN/XL/W/X2	
○		Start	P.SN/XDP/S/X2	○		Start	P.SN/XL/W/X2	
●	+	Increase	P.SN/XDP/S/X4	+	Increase		P.SN/XL/W/X4	
	-	Decrease	P.SN/XDP/S/X5	-	Decrease		P.SN/XL/W/X5	
	↑	Guide motion	P.SN/XDP/S/X7	↑	Guide motion		P.SN/XL/W/X7	
	↗	Guide motion	P.SN/XDP/S/X8	↗	Guide motion		P.SN/XL/W/X8	
	✋	Hand-control	P.SN/XDP/S/X9	✋	Hand-control		P.SN/XL/W/X9	
	⌚	Automatic cycle	P.SN/XDP/S/X10	⌚	Automatic cycle		P.SN/XL/W/X10	
	⌚	Inching	P.SN/XDP/S/X11	⌚	Inching		P.SN/XL/W/X11	
	⌚	Disengaging	P.SN/XDP/S/X12	⌚	Disengaging		P.SN/XL/W/X12	
	⌚	Unlocking	P.SN/XDP/S/X13	⌚	Unlocking		P.SN/XL/W/X13	
	⌚	Tighten	P.SN/XDP/S/X14	⌚	Tighten		P.SN/XL/W/X14	
	⌚	Release	P.SN/XDP/S/X15	⌚	Release		P.SN/XL/W/X15	
	⌚	Liquid	P.SN/XDP/S/X16	⌚	Liquid		P.SN/XL/W/X16	
	⌚	Liquid	P.SN/XDP/S/X16	⌚	Liquid		P.SN/XL/W/X16	
	⌚	Horn	P.SN/XDP/S/X17	⌚	Horn		P.SN/XL/W/X17	



PUSH BUTTONS AND PILOT LIGHTS

Technical data

			Contact blocks	LED elements	Push buttons, mushroom P/B spring return	Double-push buttons	Rotary switches, rotary switches illuminated
General							
Standards and requirements			IEC/EN 60947, VDE 0660				
Mechanical life	Operations	x 10 ⁶	5	-	5	0,2	0,1
Max. operating frequency		S/h	3600	-	3600	3600	2000
Operating force		N	≤ 5	-	≤ 5	≤ 5	-
Operating torque		Nm	≤ 0,8 (Terminals)	≤ 0,8 (Terminals)	-	-	≤ 0,3
Degree of protection IEC/EN 60529			IP 20	IP 20	IP 67 / IP 69K	IP 67 / IP 69K	IP 66
Environmental resistance			Humidity, constant, acc. to IEC 60068-2-78				
			Humidity, cyclic, acc. to IEC 60068-2-30				
Ambient temperature	min./max.	°C	-25 / +70	-25 / +70 ¹	-25 / +70	-25 / +70	-25 / +70
Mounting position			any				
Shock withstand acc. to IEC 60068-2-27		g	> 30				
Shock period 11 ms, sinus wave							
Terminal cross-sections							
single wire	min. – max.	mm ²	0,75–2,5	0,75–2,5	-	-	-
stranded wire	min. – max.	mm ²	0,5–2,5	0,5–2,5	-	-	-
Current paths							
Rated impulse withstand voltage U _{imp}		V	6000	6000	-	-	-
Rated insulation voltage U _i		V	500	500	-	-	-
Overvoltage category/			III/3	III/3	-	-	-
Pollution degree					-	-	-
Control circuit reliability at					< 10 ⁻⁷ , < 1 failure per 10 ⁷ operations		
24 V DC/5 mA	Fault frequency H _F				< 5 x 10 ⁻⁶ , < 1 failure per 5 x 10 ⁶ operations		
5 V DC/1 mA	Fault frequency H _F						
Max. face size	Characteristic	A gI/gG	10	-	-	-	-
Switching capacity							
Rated operational current I _e							
AC-15	115 V	A	6	-	-	-	-
	230 V	A	6	-	-	-	-
	400 V	A	4	-	-	-	-
	500 V	A	2	-	-	-	-
DC-13	24 V	A	3	-	-	-	-
	42 V	A	1,7	-	-	-	-
	60 V	A	1,2	-	-	-	-
	110 V	A	0,6	-	-	-	-
	220 V	A	0,3	-	-	-	-
Electrical life							
AC-15	230 V / 0,5 A	Operations	x 10 ⁶	1,6	-	-	-
	230 V / 1,0 A	Operations	x 10 ⁶	1,0	-	-	-
	230 V / 3,0 A	Operations	x 10 ⁶	0,7	-	-	-
DC-13	12 V / 2,8 A	Operations	x 10 ⁶	1,2	-	-	-
Approvals							
Technical data On request			USA/Kanada				

IEC/EN 609
> 0,1
IP 67/IP 69K
Humidity
-25/+40

¹ > 200 V AC/60 Hz: -25/+55 °C



Technical data







			Rotary switches key operated	Potentiometer, Solid pilot lights	Pilot lights	Push buttons, Push buttons illuminated, Mushroom P/B latched	Emergency-stop/ OFF push buttons
General							
Standards and requirements			IEC/EN 60947, VDE 0660				
Mechanical life	Operations	$\times 10^6$	> 0,1			> 0,1	> 0,1
Max. operating frequency		S/h	100			1800	600
Operating force		N				≤ 5	≤ 50
Operating torque		Nm	$\leq 0,5$				
Degree of protection IEC/EN 60529			IP 66	IP 66 (Potentiometer) IP 67/IP 69K (Pilot lights)	IP 67/IP 69K	IP 67/IP 69K	reset by turning IP 66/IP 69K reset by pulling IP 66/IP 69K
Environmental resistance			Humidity, constant, acc. to IEC 60068-2-78 Humidity, cyclic, acc. to IEC 60068-2-30				
Ambient temperature	min. / max.	°C				-25 / +70	
Mounting position			any				
Shock withstand acc. to IEC 60068-2-27			g	> 30	> 30	> 30	> 50
Shock period 11 ms, sinus wave							
Terminal cross-sections							
single wire	min. – max.	mm ²		0,5–1,5			
stranded wire	min. – max.	mm ²		0,5–1,5			
Current paths							
Rated impulse withstand voltage U_{imp}			V	4000			
Rated Insulation voltage U_i			V	250			
Overvoltage category/ Pollution degree				III/3			
Approvals							
Technical data On request			UL/CSA/GOST				

			Foot and palm switches latched				
General							
Standards and requirements			IEC/EN 60947, VDE 0660				
Mechanical life	Operations	$\times 10^6$	> 0,1				
Max. operating frequency		S/h	600				
Operating force		N	≤ 60				
Degree of protection IEC/EN 60529			IP 67/IP 69K				
Environmental resistance			Humidity, constant, acc. to IEC 60068-2-78 Humidity, cyclic, acc. to IEC 60068-2-30				
Ambient temperature	min. / max.	°C	-25 / +40				
Mounting position			any				
Shock withstand acc. to IEC 60068-2-27			g	> 15			
Shock period 11 ms, sinus wave							
Terminal cross-sections							
single wire	min. / max.	mm ²	0,75–2,5				
stranded wire	min. / max.	mm ²	0,5–2,5				
Current paths							
Rated impulse withstand voltage U_{imp}			V	6000			
Rated Insulation voltage U_i			V	500			
Overvoltage category/ Pollution degree				III/3			
Approvals							
Technical data On request			USA/Kanada				

IEC/EN 609
> 0,1
IP 67/IP 69K
Humidity
-25 / +40

Technical data

Approvals and Standards ⁹





	 ¹	 ²	 ³	EN 60947 ⁴ IEC 60947 ⁵	 ⁶ GB/T14048.3			
Type (alphanumeric sorting)	CULUS	CURUS	CSA	EN IEC	CCC	EAC	Russian Mar. Register of Shipping	EMEA
Control Switches								
C125	A		A	C	A	A		
C315		A	A	C	A	A		
C80	A		A	C	A	A		
CA10/B	A		A	C	A	A	A	A
CA10X	A		A	C				
CA11/B	A		A	C		A	A	
CA20/B	A		A	C	A	A	A	
CA20X	A		A	C		A		
CA25/B	A		A	C	A	A	A	
CA4	A		A	C		A	A	
CA4-1	A		A	C		A	A	
CA40, CA50, CA63	A			C		A		
CAD11/B	A		A	C	A	A		
CG4	A		A	C	A	A		
CG4-1	A		A	C	A	A		
CG8/B	A		A	C	A	A		
CGD4-1	A			C				
CH10/B	A		A	C	A	A		A
CH11/B	A		A	C		A		
CH16/B	A		A	C	A	A		A
CH6	A		A	C		A		
DH10/11/B	A			C		A		
Switches for special use								
A11	A		A	C				
A11C	A			C				
AD11		A	A	C				
A25, A25C	A			C				
CHR10/16/B		A	A	C	A	A		
CHR11		A	A	C		A		
DHR10/11/B		A		C				
DK10/11	A			C		A		
G20		A		C	A			
G20S		A ⁸		C	A			
L1200		A	A	C		A		
L1600		A	A	C		A		
L2000			A	C		A		
L350/1, L630/1, L1000		A	A	C		A		
L400	A		A	C		A		
L600, L800		A	A	C		A		
Emergency-stop/OFF push buttons and switch disconnectors ⁷								
C316		A	A	C	A	A		
KG10/A/B	A		A	C		A		
KG100, KG100C	A		A	C	A	A	A	
KG125	A		A	C	A	A		
KG126, KG127	A	A	A	C	A	A		
KG160	A		A	C	A	A		
KG161, KG162		A	A	C	A	A		
KG20/A/B	A		A	C	A	A	A	A
KG210	A		A	C		A		
KG211, KG212		A	A	C		A		
KG250	A		A	C	A	A		
KG251, KG252		A	A	C	A	A		
KG315	A		A	C	A	A		
KG316, KG317		A	A	C	A	A		
KG32/A/B	A		A	C	A	A	A	A
KG41/B	A		A	C	A	A	A	A
KG64/B	A		A	C	A	A	A	A
KG80	A		A	C	A	A	A	A
KG80C	A		A	C	A	A	A	

A = approved C = in compliance with the corresponding regulation

¹ **United States and Canadian National Standards-Listed** Approved under the „Listing-Program“. File No. E35541, Category Control Number NLRV and NLRV7 respectively File No. E60262, Category Control Number NRNT and NRNT7. | ² **United States and Canadian National Standards-Recognized** Approved under the „Component Program“ (UL-Recognized Industrial Component). File No. E35541, Category Control Number NLRV2 and NLRV8 respectively File No. E60262, Category Control Number NRNT2 and NRNT8. | ³ **Canadian Standards Association** File No. 13002, Class No. 321105 bzw. 465204. | ⁴ It is not required for industrial switchgear to bear a symbol but must conform to requirement. By stating the specific standards no. on the product the manufacturer declares that all requirements of the product standard are met. | ⁵ IEC does not operate an approval scheme. | ⁶ If you need an approval, you have to tell this with your order additional. | ⁷ Switch types of the KG-series as well as C316 are approved under UL508 and CSA-22.2 No. 14-05 as „disconnect switches for use in motor circuits“ and only to be used for branch circuit. Switches in enclosure are not approved. | ⁸ Approved with TD... and D..., not the special switches with T000... and WA... | More approvals please see homepage: www.krausnaimer.com ➔ Certificates & Guide | ⁹ for AC applications, DC applications on request.

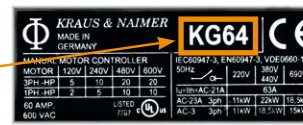



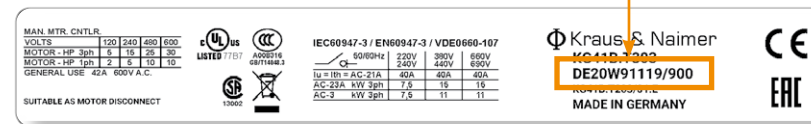

- Ordering example for replacement needs of main switches -
The most important information for ordering replacement supplies

Etiketten bis 2019	 <p>1.</p> 	 <p>2.</p> 
Etiketten ab 2020	 	

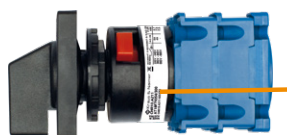
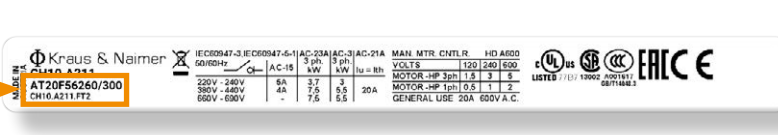

Should details not be available or incomplete, send us significant pictures of the switch.

- Ordering example for replacement needs of control switches -
The most important information for ordering replacement supplies

Etiketten bis 2019	 <p>1.</p> 	 <p>2.</p> 
Etiketten ab 2020	 	

Should details not be available or incomplete, send us significant pictures of the switch and the description of the electrical properties according to form for special switches.
Additional we need information of mounting type of your switches (e.g. Single or 4-hole panel mounting, DIN rail mounting, with enclosure...)

- Ordering example -

Switch type and electrical date	Switch function	Mounting
<p>e.g. CH10</p> 	<p>e.g. A292</p> 	<p>e.g. FT2</p> 

Optional extras (sub-item)

e.g. **CH10 A292 *FT2**
50 V750D/3G



USEFUL INFORMATION

The principle of a cam switch

The cam switch is a hand-operated switching device, in which a rotary movement of the handle, on an axis slice with projections, is transmitted. About these projections, also called cam, the rotational movement is converted into longitudinal movements of the plunger. These, in turn, open or close double-break contacts.

Most cam switches have two contacts in a switching chamber, the so-called escape. At a total switching angle from 180°, it allows the use of a second cam plate one from each other independent actuation of the two contacts.

The switching angle between the positions is specified via a star in the detent mechanism. Within this, also a stop is located that limits the total switching angle of the rotation via another cam.

This structure allows a modular principle, which upgrades a few items almost up to an infinite number of custom switching programs.

Example based on multi-step switch

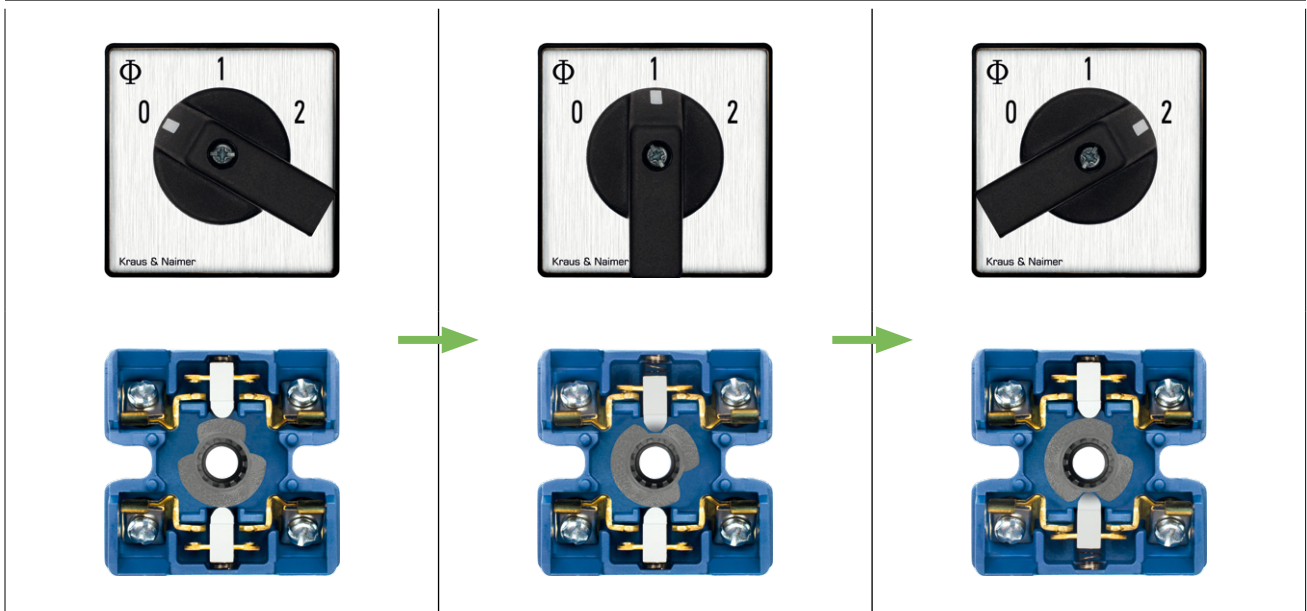

Spring loaded contacts

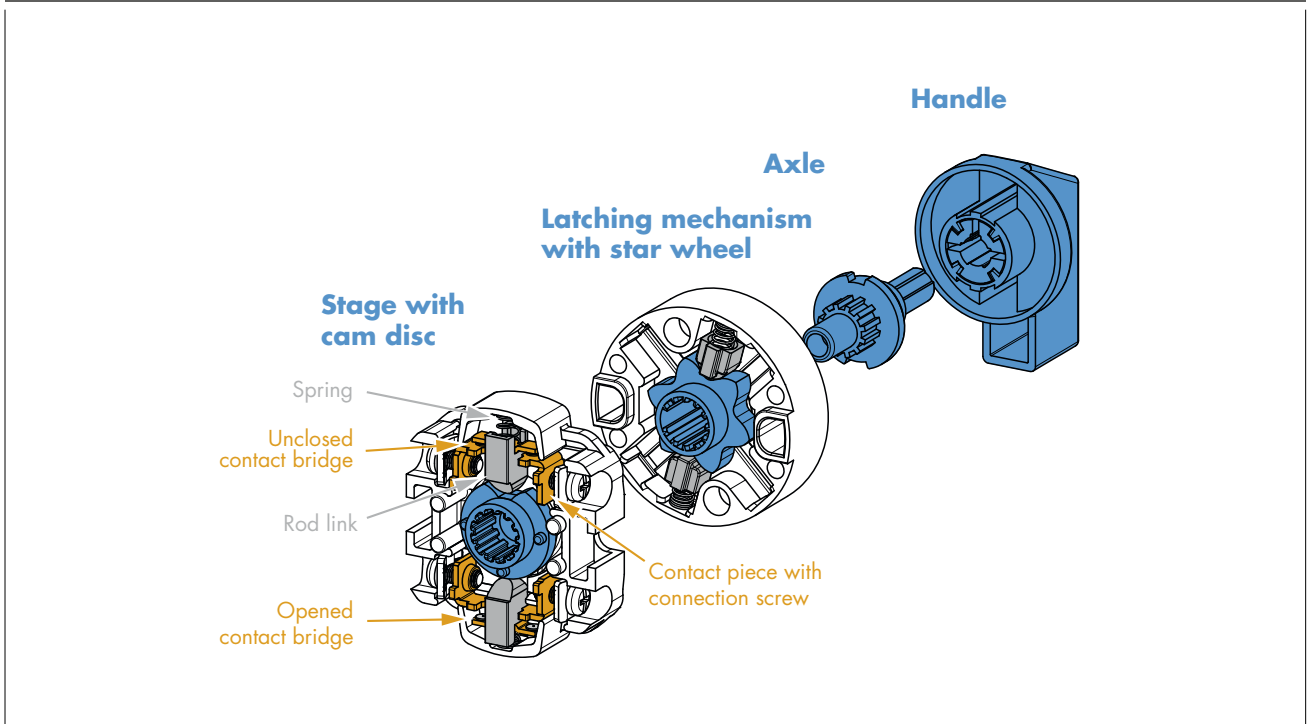

ATEX groups and category of equipment

Group I comprises equipment intended for use in the underground parts of mines, and to those parts of surface installations of such mines, likely to become endangered by firedamp and/or combustible dust.

Group II comprises equipment intended for use in other places likely to become endangered by explosive atmospheres.

These groups are sub-divided into categories, as shown below. The way in which this categorisation has been developed highlights one of the main distinctions of Group I and II.

For Group I, the categorisation depends on (amongst other factors) whether the product is to be deenergized in the event of an explosive atmosphere occurring.

For Group II, it depends where the product is intended to be used in and whether a potentially explosive atmosphere, is always present, or is likely to occur for a long or a short period of time.

Group I: Underground and above ground installations for mining industry with hazardous choke damp and mine dust		
Category	Accepting	
Category M1	Very high level of protection	Safety in the event of two faults occurring independently of each other
Category M2	High level of protection	Device must be turned OFF in case of potentially explosive atmosphere

Group II: Other ex-areas					
Category	Accepting of danger	Accepting		Zone	Substance class
Category 1	Highly likely to occur and are present continuously, for long periods of time or frequently	Very high level of protection	Safety in the event of two faults occurring independently of each other	Zone 0	G (Gases)
				Zone 20	D (Dusts)
Category 2	Likely	High level of protection	Safety in the event of one fault	Zone 1	G (Gases)
				Zone 21	D (Dusts)
Category 3	Unlikely	Normal level of protection	Suitable for normal operation	Zone 2	G (Gases)
				Zone 22	D (Dusts)

EMC

Maintenance switches for EMC-compliant connection of variable speed drives are available either with shield clips (KS- and KL-enclosures) or with clips mounted on DIN rails (STM-enclosure). These clips are used to continue the cable shield circuit through the enclosure.

The configuration of the Maintenance switch between Frequency Converter (FC) and motor allows the use as Disconnecter up to 400 Hz and as load switch at frequencies from 40 to 100 Hz.

Each Maintenance switch has a standard 2 Auxiliary contacts, 1 NC and 1 NO. Via the NO (20 ms leading) the FC can be switched OFF before the main contacts of the switch open.

For the rating of the switch please note that the motor may have approx. 10 % higher charging rate due to the higher loss in FC-operation e.g. a motor with 7,5 kW rating the motor current has to be determined with 16,7 A instead of 15,2 A.

The letters IP combined with a double digit specify the degrees of protection. The IP code identify the scope of protection for enclosures relating to solid particle protection (first digit) and liquid ingress protection (second digit).

e.g. IP 6 7

First digit		Solid particle protection	Second digit		Liquid ingress protection
0		No protection against contact and ingress of objects	0		None
1		Protection against any large surface of the body $\varnothing > 50$ mm (hand), but no protection against deliberate contact with a body part	1		Protection against dripping water (vertically falling drops)
2		Protection against any surface of the body $\varnothing > 12,5$ mm (fingers)	2		Protection against dripping water when tilted at 15°
3		Protection against objects $\varnothing > 2,5$ mm (tools, thick wires)	3		Protection against spraying water at any angle up to 60°
4		Protection against objects $\varnothing > 1$ mm (most wires, large ants)	4		Protection against splashing water from any direction
5		Dust protected	5		Protection against water jets from any direction by a nozzle (6.3 mm)
6		Dust tight	6		Protection against powerful water jets from any direction by a nozzle (12.5 mm)
			7		Suitable for temporary immersion in water up to 1 m depth
			8		Suitable for continuous immersion in water specified by the manufacturer
			9k		Protected against close-range high pressure, high temperature spray downs Water pressure: 100 bar Water temperature: 80 °C



Definition

(References: EN 60947 und EN 60204)

Utilization category of switchgear

Standard utilization categories define the current making and breaking values for switches/contactors for the purpose to enable the selection for the proper switchgear for a particular application.
Utilization Categories are depending on the following:

- The type of load to be controlled (squirrel cage or slip ring motor, resistors)
- The operating cycle conditions (motor running, stalled or starting, reverse operation, counter-current braking)

Control switch



A device capable of making, carrying and breaking current within an electrical circuit under defined conditions.

Disconnecter



A device capable of carrying current within an electrical circuit and providing OFF-load isolation within that circuit in accordance with the specified requirements for safety isolation.

Switch disconnecter



Switch disconnecters in their open position fulfil all of the functional demands of an isolator.

Disconnect Functionality

Functionality to disconnect an electrical systems completely or electrical sub parts of a system form the electrical power source for safety reasons.

Main Switch (Power Disconnect)

A main switch can be designed as a load break switch or disconnect switch. The load break switch has to fulfill all requirements of utilization category AC23B or higher. The selection of the disconnect switch happens according to the Thermal current. In addition the disconnect switch has to have an auxiliary contact to enable the load break via a contactor. The auxiliary contact has to have a sufficient AC-15 switching capacity.

When using a load break switch as main switch the Breaking capacity has to be considered. The Breaking capacity has to match the current of the biggest motor in a system with blocked breaks additionally the sum of all nominal currents of all other electricity consumers in the machine or system. In addition to that the sum of the rated currents of all electricity consumers must not exceed the tolerable limit of the Thermal current of the switch. For main switches with emergency stop functionality the same selection criteria apply.

Direct opening action

Contact opening action which ensures that all contacts are in an open stage, when the switch handle is in „OFF“ position, according defined conditions.

Positively driven operation

Switching action which ensures that the Auxiliary contacts of a mechanical switch are matching the switch status of the main contacts („OPEN“ or „CLOSED“) indicated by the handle position („ON“ or „OFF“).

Control switch (auxiliary circuit switch)

Switch types intended for use as control switch for isolation with direct opening action according to Annex K of IEC 60947-5-1:2016, EN 60947-5-1:2017 and VDW 0660 Part 200:03:2018 referring to Low-Voltage Switchgear and Controlgear, Control Circuit Devices and Switching Elements.

Comparison of mounting holes PG versus metric

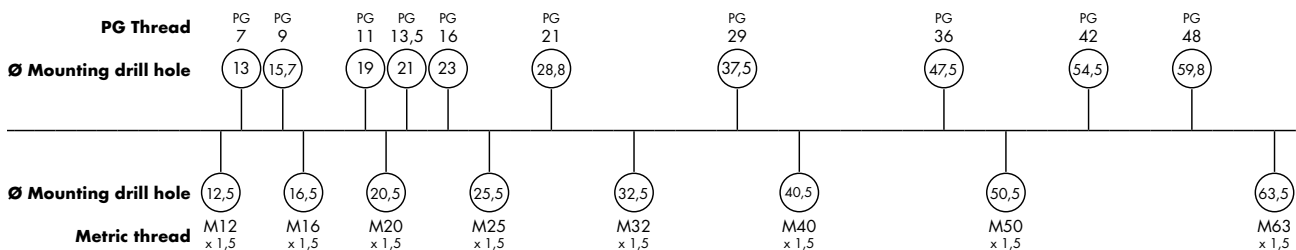

Utilization category of switchgear

(References: EN 60947 und EN 60204)

AC operation

Frequently operation	Occasional operation	Type of application
AC-20A	AC-20B	Connecting and disconnecting under no-load conditions
AC-21A	AC-21B	Switching of resistive loads, including moderate overloads
AC-22A	AC-22B	Switching of mixed resistive and inductive loads, including moderate overloads
AC-23A	AC-23B	Switching of motor loads or other highly inductive loads
		AC-3
		AC-15
		Squirrel-cage motors: starting, switches OFF motors during running time
		Control of AC electromagnetic loads (> 72 VA)

DC operation

Frequently operation	Occasional operation	Type of application	Prospective breaking current
DC-13		Control of DC electromagnetics	$6 \times I_e$
DC-20A	DC-20B	Connecting and disconnecting under no-load conditions	-
DC-21A	DC-21B	Switching of resistive loads, including moderate overloads	$1,5 \times I_e$
DC-22A	DC-22B	Switching of mixed resistive and inductive loads, including moderate overloads (e.e. shunt motors)	$4 \times I_e$
DC-23A	DC-23B	Switching of highly inductive loads (i.e. series motors)	$4 \times I_e$

Conversion table american wire gages (AWG) into mm²

(Reference: EN 60947-1)

ISO-wire gages (mm ²)	Relation between AWG/MCM-Sizes and metrical wire gages	
	AWG/MCM-Size	Converted metrical wire gage (mm ²)
0,2	24	0,205
-	22	0,324
0,5	20	0,519
0,75	18	0,82
1	-	-
1,5	16	1,3
2,5	14	2,1
4	12	3,3
6	10	5,3
10	8	8,4
16	6	13,3
25	4	21,2
35	2	33,6
50	0	53,5
70	00	67,4
95	000	85
-	0000	107,2
120	250 MCM	127
150	300 MCM	152
185	350 MCM	177
240	500 MCM	253
300	600 MCM	304

All dimension in this catalog are in mm

The rights to changes and misprints are reserved.

© Kraus & Naimer GmbH / 02.2019



Color coding for isolated wire ferrules

(Reference: DIN 46228 Part 4)

Nominal cross section mm ²	Color
0,5	White
0,75	Grey
1	Red
1,5	Black
2,5	Blue
4	Grey
6	Yellow
10	Red
16	Blue
25	Yellow
35	Red
50	Blue
70	Yellow
95	Red
120	Blue
150	Yellow

Keys for harmonized power cables

Identification of provision

Harmonised provision
Approved national type

Voltage U₀/U

100/100V
300/300V
300/500
450/750V
700/1000V

Insulation material

Polvinyl chloride (PVC)
Natur and/or styrene butadiene rubber (SBR)
Silicone rubber

Sheath material

PVC
Natur and/or styrene butadiene rubber (SBR)
Polychloroprene rubber
Glass fibre braid
Textile fabric
Textile fabric flame-resistant
Ethylene-propylene rubber

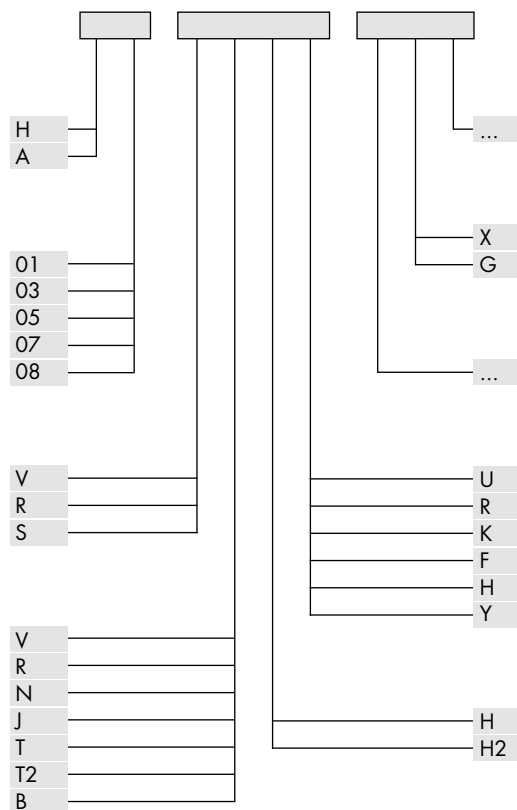

Nominal cross-section

0,5 up to 500mm²

Protective conductor

Without PE conductor
With PE conductor

Wire count

Number of single conductors

Cable type

U Single-wire
R Stranded, finely stranded conductor
K Permanent installation
F Finely stranded for flexible cables
H Very finely stranded for flexible cables
Y Tinsel wire

Special features of structure

H flat, divisible cable
H2 flat, indivisible cable

Example

H05V-K 1,5 SW = PVC wiring conductor 1,5 mm², finely stranded, black
A07RN-F 3 X 2,5 = Strong rubber hose, 3 core, 2,5 mm², without green-yellow PE conductor

Austria

Kraus & Naimer Produktion GmbH
Schumanngasse 35
1180 WIEN
T: +43 1 404 06-0
E: salesKNW@krausnaimer.com
www.krausnaimer.at

Australia

Kraus & Naimer Pty. Ltd.
ASHFIELD, NSW 2131
T: +61 2 9797 7333
E: sales-au@krausnaimer.com

Belgium

Kraus & Naimer BV
1930 ZAVENTEM
T: +32 2 757 01 41
E: sales-be@krausnaimer.com
www.krausnaimer.com

Brasil

Kraus & Naimer Ind. e Com. Ltda.
1061 - Cotia - SP - 06715-865
T: +55 11 2198-1288
E: knbrasil@krausnaimer.com.br

Canada

Kraus & Naimer Ltd.
CONCORD, ONTARIO, L4K 1L4
T: +1 905 738-1666
E: sales-ca@krausnaimer.com

Caribbean

Kraus & Naimer B.V.
NL - 7556 BR HENGELO
T: +31 74 - 291 94 41
E: sales-nl@krausnaimer.com

China

Kraus & Naimer Pte. Ltd.
SGP - SINGAPORE 149 596
T: +65 6473 8166
E: sales-sg@krausnaimer.com

Cyprus

Electromatic Constructions Ltd.
2251 LATSIA-NICOSIA
T: +357 2 48 41 41
E: electromatic@cytanet.com.cy

Czech Republic

Obzor
763 02 ZLIN
T: +420 577 195 150
E: odbyt@obzor.cz
www.obzor.cz

Denmark

Thiim A/S
2860 SOEBORG
T: +45 44 85 80 00
E: thiim@thiim.com
www.thiim.com

Finland

Kraus & Naimer Oy
01530 VANTAA
T: +358 9 8254240
E: sales-fi@krausnaimer.com

France

Kraus & Naimer s.a.s.
75013 PARIS
T: +33 1 58 40 80 80
E: sales-fr@krausnaimer.com

Germany

Kraus & Naimer GmbH
Kraus & Naimer Produktion GmbH
76189 KARLSRUHE
T: +49 721 59 88-0
E: sales-de@krausnaimer.com
www.krausnaimer.de

Great Britain

Kraus & Naimer Limited
NEWBURY/BERKSHIRE
RG14 2AH
T: +44 1635 262626
E: sales-uk@krausnaimer.com
www.krausnaimer.co.uk

Greece

Kalamarakis-Sapounas Ltd.
13671 CHAMOMILOS/
ACHARNES Athens
T: +30 1 2406000-6
E: kalamarakis.sapounas@ksa.gr

Hongkong

Kraus & Naimer Pte. Ltd.
SGP - SINGAPORE 149 596
T: +65 6473 8166
E: sales-sg@krausnaimer.com

Hungary

Ganz KK Kft.
1475 BUDAPEST
T: +36 1 261-1115
E: ganzkk@ganzkk.hu

Iceland

Johan Rønning Ltd.
104 REYKJAVÍK
T: +354 5200 800
E: ronning@ronning.is
www.ronning.is

India

Kraus & Naimer Pte. Ltd.
SGP - SINGAPORE 149 596
T: +65 6473 8166
E: sales-sg@krausnaimer.com

Indonesia

Kraus & Naimer Pte. Ltd.
SGP - SINGAPORE 149 596
T: +65 6473 8166
E: sales-sg@krausnaimer.com

Ireland

Kraus & Naimer Ltd.
SHANNON, CO. CLARE
T: +353 61 704700
E: sales-ie@krausnaimer.com

Italy

Kraus & Naimer s.r.l.
24047 TREVIGLIO (BG)
T: +39 0363-30 11 12
E: sales-it@krausnaimer.com

Japan

Kraus & Naimer Ltd.
TOKYO 105-0013
T: +81 3 3436-6151
E: sales-jp@krausnaimer.com

Korea

Kraus & Naimer Pte. Ltd.
SGP - SINGAPORE 149 596
T: +65 6473 8166
E: sales-sg@krausnaimer.com

Luxembourg

Kraus & Naimer B.V.
NL-7556 BR Hengelo
T: +31 74 - 291 94 41
sales-nl@krausnaimer.com
www.krausnaimer.com

Malaysia

Kraus & Naimer Pte. Ltd.
SGP - SINGAPORE 149 596
T: +65 6473 8166
E: sales-sg@krausnaimer.com

Mexico

JC Ingeniería y Control, SA de CV.
NAUCALPAN EDO. DE MEXICO
C.P. 53100
T: +52 55 55 62 75 77
E: ventas@jcingenieriacontrol.com

Middle East

Kraus & Naimer Pte. Ltd.
SGP - SINGAPORE 149 596
T: +65 6473 8166
E: sales-sg@krausnaimer.com

Netherlands

Kraus & Naimer B.V.
7556 BR HENGELO
T: +31 74 291 94 41
E: sales-nl@krausnaimer.com
www.krausnaimer.com

New Zealand

Kraus & Naimer Ltd.
US-WELLINGTON 6243
T: +4 380 9888,
E: sales-nz@krausnaimer.com

Norway

Kraus & Naimer AB Avd. Norge
0582 OSLO
T: +47 22 64 44 20
E: sales-no@krausnaimer.com

Pakistan

Kraus & Naimer Pte. Ltd.
SGP - SINGAPORE 149 596
T: +65 6473 8166
E: sales-sg@krausnaimer.com

Philippines

Kraus & Naimer Pte. Ltd.
SGP - SINGAPORE 149 596
T: +65 6473 8166
E: sales-sg@krausnaimer.com

Poland

Astat Logistyka Sp. z o.o.
UL. DABROWSKIEGO 441
T: +48 61 848-88-71
E: k.swiderski@astat.pl
www.astat.com.pl

Portugal

Electricol-Damas,
Ferreira & Damasceno, LDA.
2670 LOURES
T: +351 21 989-8939
E: electricol@electricol.pt
www.electricol.pt

Russian Federation

Kraus & Naimer Oy
FIN-01530 VANTAA
T: +358 9 825-424-0
E: sales-fi@krausnaimer.com

Singapore

Kraus & Naimer Pte. Ltd.
SINGAPORE 149 596
T: +65 6473 8166
E: sales-sg@krausnaimer.com

Slovenia

SCHRACK Technik d.o.o.
2380 SLOVENJ GRADEC
T: +386 2 88 392 00
E: d.goljat@schrack.si
www.schrack.si

South Africa

Kraus & Naimer Pty. Ltd.
2065 SANDTON
T: +27 11 608-6060
E: sales-za@krausnaimer.com
www.krausandnaimer.co.za

Spain

Kraus & Naimer B.V.
NL - 7556 BR Hengelo
T: +31 74 - 291 94 41
E: sales-nl@krausnaimer.com
www.krausnaimer.com

Sri Lanka

Kraus & Naimer Pte. Ltd.
SGP - SINGAPORE 149 596
T: +65 6473 8166
E: sales-sg@krausnaimer.com

Sweden

Kraus & Naimer AB
126 14 STOCKHOLM
T: +46 8 97 00 80
E: sales-se@krausnaimer.com

Switzerland

AWAG Elektrotechnik AG
8604 VOLKETSCHWIL
T: +41 44 908 19 19
E: info@awag.ch
www.awag.ch

Taiwan

Kraus & Naimer Pte. Ltd.
SGP - SINGAPORE 149 596
T: +65 6473 8166
E: sales-sg@krausnaimer.com

Turkey

KARDES Elektrik San. ve Tic. A.S.
34277 ARNAVUTKOY-ISTANBUL
T: +90 212 624 92 04-118
E: info@unalkardes.com.tr
www.kardeselektrik.com.tr

Thailand

Kraus & Naimer Pte. Ltd.
SGP - SINGAPORE 149 596
T: +65 6473 8166
E: sales-sg@krausnaimer.com

USA

Kraus & Naimer Inc.
SOMERSET, NJ 08873
T: +1 732 560-1240
E: sales-us@krausnaimer.com
www.krausnaimer.us

Vietnam

Kraus & Naimer Pte. Ltd.
SGP - SINGAPORE 149 596
T: +65 6473 8166
E: sales-sg@krausnaimer.com



 Kraus & Naimer

www.krausnaimer.com

Follow us on



© Kraus & Naimer 7/2021