

**CARLO GAVAZZI**  
Automation Components



**Our Products**

## Sensors

Inductive sensors	8
Capacitive sensors	32
Photoelectric sensors	46
Photoelectric sensors accessories	69
Conductive sensors	72
Magnetic sensors	76
Ultrasonic sensors	83
Motion and presence sensors	90
Environmental sensors	92
Intrinsic safety	96
Safety light curtains	97
Safety magnetic sensors	99
Connectors and brackets	100

## Switches

Solid state relays	104
Solid state relays accessories	134
Soft starters	139
Motor protection relays	143
Variable speed drives	145
Limit switches	149
Electromechanical relays	158
Sockets for electromechanical relays	161

## Controls

Energy management	164
Current transformers	176
Energy monitoring solution	184
PV monitoring solution	187
Monitoring relays	192
Timers	204
Counters	209
Surge arresters	212
Digital panel meters	214
Converters and Gateway	218
Safety modules	219
Configurable safety modules	223
Switching power supplies	225

## Fieldbuses

Dupline® Home and Building automation	236
Dupline® Parking guidance system	251
Dupline® DuplineSafe	255
Dupline® Industrial	257
Dupline® Irrigation	270
Dupline® Elevator	271



## A complete product range

### ABOUT CARLO GAVAZZI

Carlo Gavazzi Automation is a multinational electronics group active in the design, manufacture and marketing of electronic equipment targeted at the global markets of industrial and building automation.

Our history is full of firsts and our products are installed in a huge number of applications all over the world. With more than 80 years of successful operation, our experience is unparalleled.

We have our headquarters in Europe and numerous offices around the world.

Our R&D competence centres and production sites are located in Denmark, Italy, Lithuania, Malta and the People's Republic of China.

We operate worldwide through 22 of our own sales companies and also selected representatives in more than 65 countries, from the United States in the West to the Pacific Rim in the East.

Our core competence in automation spans four product lines: Sensors, Switches, Controls and Fieldbuses.

Our wide array of products includes sensors, monitoring relays, timers, energy management systems, solid state relays, safety devices and fieldbus systems.

We focus our expertise on offering state-of-the-art product solutions in selected market segments.

Our customers include original equipment manufacturers of packaging machines, plastic-injection moulding machines, food and beverage production machines, conveying and materials handling equipment, door and entrance control systems, lifts and escalators, as well as heating, ventilation and air-conditioning devices.



## A guarantee of reliability

Carlo Gavazzi products earned the independent approval of the relevant bodies which govern our industry and the many markets we serve.

They are developed and manufactured in full compliance with the most important international standard regulations.

Carlo Gavazzi manufacturing facilities operates in line with the requirements of ISO9001:2008 Quality Management Systems and ISO14001:2004 Environmental Management System standard.











# Sensors









Inductive sensors	8
Capacitive sensors	32
Photoelectric sensors	46
Photoelectric sensors accessories	69
Conductive sensors	72
Magnetic sensors	76
Ultrasonic sensors	83
Motion and presence sensors	90
Environmental sensors	92
Intrinsic safety	96
Safety light curtains	97
Safety magnetic sensors	99
Connectors and brackets	100

## Inductive proximity sensors, 3-wire, DC



Types	M12 Standard - Short body		M12 Standard - Long body	
Connections	2 m cable	M12 connector	2 m cable	M12 connector
<b>Flush mountable</b>				
Dimensions (mm)	M12 x 47	M12 x 50	M12 x 67	M12 x 70
Thread (mm)	M12 x 1 x 30	M12 x 1 x 30	M12 x 1 x 50	M12 x 1 x 50
Operating frequency	2 kHz	2 kHz	2 kHz	2 kHz
Sensing distance (Sn)	2 mm	2 mm	2 mm	2 mm
<b>References</b>				
NPN-NO	ICB12S30F02NO	ICB12S30F02NOM1	ICB12L50F02NO	ICB12L50F02NOM1
PNP-NO	ICB12S30F02PO	ICB12S30F02POM1	ICB12L50F02PO	ICB12L50F02POM1
NPN-NC	ICB12S30F02NC	ICB12S30F02NCM1	ICB12L50F02NC	ICB12L50F02NCM1
PNP-NC	ICB12S30F02PC	ICB12S30F02PCM1	ICB12L50F02PC	ICB12L50F02PCM1
<b>Non-flush mountable</b>				
Dimensions (mm)	M12 x 51	M12 x 54	M12 x 71	M12 x 74
Thread (mm)	M12 x 1 x 30	M12 x 1 x 30	M12 x 1 x 50	M12 x 1 x 50
Operating frequency	2 kHz	2 kHz	2 kHz	2 kHz
Sensing distance (Sn)	4 mm	4 mm	4 mm	4 mm
<b>References</b>				
NPN-NO	ICB12S30N04NO	ICB12S30N04NOM1	ICB12L50N04NO	ICB12L50N04NOM1
PNP-NO	ICB12S30N04PO	ICB12S30N04POM1	ICB12L50N04PO	ICB12L50N04POM1
NPN-NC	ICB12S30N04NC	ICB12S30N04NCM1	ICB12L50N04NC	ICB12L50N04NCM1
PNP-NC	ICB12S30N04PC	ICB12S30N04PCM1	ICB12L50N04PC	ICB12L50N04PCM1
<b>Characteristics flush and non-flush mountable</b>				
Rated operating voltage	10 - 36 VDC	10 - 36 VDC	10 - 36 VDC	10 - 36 VDC
Voltage drop	≤ 2.5 VDC @ 200 mA	≤ 2.5 VDC @ 200 mA	≤ 2.5 VDC @ 200 mA	≤ 2.5 VDC @ 200 mA
Degree of protection	IP 67	IP 67	IP 67	IP 67
Protection Short-circuit (S) Reverse polarity (P) Transients (T)	SPT	SPT	SPT	SPT
Output current	< 200 mA @ 50°C ≤ 150 mA @ 50-70°C	< 200 mA @ 50°C ≤ 150 mA @ 50-70°C	< 200 mA @ 50°C ≤ 150 mA @ 50-70°C	< 200 mA @ 50°C ≤ 150 mA @ 50-70°C
Housing material	Nickel-plated brass	Nickel-plated brass	Nickel-plated brass	Nickel-plated brass
Operating temperature	-25°C to +70°C	-25°C to +70°C	-25°C to +70°C	-25°C to +70°C
LED colour	Yellow	Yellow	Yellow	Yellow
Approvals/Marks	CE - UL	CE - UL	CE - UL	CE - UL





## Inductive proximity sensors, 3-wire, DC, extended range

Types	M12 Extended - Short body		M12 Extended - Long body	
Connections	2 m cable	M12 connector	2 m cable	M12 connector
<b>Flush mountable</b>				
Dimensions (mm)	M12 x 47	M12 x 50	M12 x 67	M12 x 70
Thread (mm)	M12 x 1 x 30	M12 x 1 x 30	M12 x 1 x 50	M12 x 1 x 50
Operating frequency	2 kHz	2 kHz	2 kHz	2 kHz
Sensing distance (Sn)	4 mm	4 mm	4 mm	4 mm
<b>References</b>				
NPN-NO	ICB12S30F04NO	ICB12S30F04NOM1	ICB12L50F04NO	ICB12L50F04NOM1
PNP-NO	ICB12S30F04PO	ICB12S30F04POM1	ICB12L50F04PO	ICB12L50F04POM1
NPN-NC	ICB12S30F04NC	ICB12S30F04NCM1	ICB12L50F04NC	ICB12L50F04NCM1
PNP-NC	ICB12S30F04PC	ICB12S30F04PCM1	ICB12L50F04PC	ICB12L50F04PCM1
<b>Non-flush mountable</b>				
Dimensions (mm)	M12 x 51	M12 x 54	M12 x 71	M12 x 74
Thread (mm)	M12 x 1 x 30	M12 x 1 x 30	M12 x 1 x 50	M12 x 1 x 50
Operating frequency	2 kHz	2 kHz	2 kHz	2 kHz
Sensing distance (Sn)	8 mm	8 mm	8 mm	8 mm
<b>References</b>				
NPN-NO	ICB12S30N08NO	ICB12S30N08NOM1	ICB12L50N08NO	ICB12L50N08NOM1
PNP-NO	ICB12S30N08PO	ICB12S30N08POM1	ICB12L50N08PO	ICB12L50N08POM1
NPN-NC	ICB12S30N08NC	ICB12S30N08NCM1	ICB12L50N08NC	ICB12L50N08NCM1
PNP-NC	ICB12S30N08PC	ICB12S30N08PCM1	ICB12L50N08PC	ICB12L50N08PCM1
<b>Characteristics flush and non-flush mountable</b>				
Rated operating voltage	10 - 36 VDC	10 - 36 VDC	10 - 36 VDC	10 - 36 VDC
Voltage drop	≤ 2.5 VDC @ 200 mA	≤ 2.5 VDC @ 200 mA	≤ 2.5 VDC @ 200 mA	≤ 2.5 VDC @ 200 mA
Degree of protection	IP 67	IP 67	IP 67	IP 67
Protection Short-circuit (S) Reverse polarity (P) Transients (T)	SPT	SPT	SPT	SPT
Output current	≤ 200 mA @ 50°C ≤ 150 mA @ 50-70°C	≤ 200 mA @ 50°C ≤ 150 mA @ 50-70°C	≤ 200 mA @ 50°C ≤ 150 mA @ 50-70°C	≤ 200 mA @ 50°C ≤ 150 mA @ 50-70°C
Housing material	Nickel-plated brass	Nickel-plated brass	Nickel-plated brass	Nickel-plated brass
Operating temperature	-25°C to +70°C	-25°C to +70°C	-25°C to +70°C	-25°C to +70°C
LED colour	Yellow	Yellow	Yellow	Yellow
Approvals/Marks	CE - UL	CE - UL	CE - UL	CE - UL

## Inductive proximity sensors, 3-wire, DC



Types	M18 Standard - Short body		M18 Standard - Long body	
Connections	2 m cable	M12 connector	2 m cable	M12 connector
<b>Flush mountable</b>				
Dimensions (mm)	M18 x 53	M18 x 54	M18 x 73	M18 x 74
Thread (mm)	M18 x 1 x 30	M18 x 1 x 30	M18 x 1 x 50	M18 x 1 x 50
Operating frequency	1.5 kHz	1.5 kHz	1.5 kHz	1.5 kHz
Sensing distance (Sn)	5 mm	5 mm	5 mm	5 mm
<b>References</b>				
NPN-NO	ICB18S30F05NO	ICB18S30F05NOM1	ICB18L50F05NO	ICB18L50F05NOM1
PNP-NO	ICB18S30F05PO	ICB18S30F05POM1	ICB18L50F05PO	ICB18L50F05POM1
NPN-NC	ICB18S30F05NC	ICB18S30F05NCM1	ICB18L50F05NC	ICB18L50F05NCM1
PNP-NC	ICB18S30F05PC	ICB18S30F05PCM1	ICB18L50F05PC	ICB18L50F05PCM1

<b>Non-flush mountable</b>				
Dimensions (mm)	M18 x 63	M18 x 64	M18 x 83	M18 x 74
Thread (mm)	M18 x 1 x 30	M18 x 1 x 30	M18 x 1 x 50	M18 x 1 x 50
Operating frequency	1.5 kHz	1.5 kHz	1.5 kHz	1.5 kHz
Sensing distance (Sn)	8 mm	8 mm	8 mm	8 mm
<b>References</b>				
NPN-NO	ICB18S30N08NO	ICB18S30N08NOM1	ICB18L50N08NO	ICB18L50N08NOM1
PNP-NO	ICB18S30N08PO	ICB18S30N08POM1	ICB18L50N08PO	ICB18L50N08POM1
NPN-NC	ICB18S30N08NC	ICB18S30N08NCM1	ICB18L50N08NC	ICB18L50N08NCM1
PNP-NC	ICB18S30N08PC	ICB18S30N08PCM1	ICB18L50N08PC	ICB18L50N08PCM1





### Characteristics flush and non-flush mountable





Rated operating voltage	10 - 36 VDC	10 - 36 VDC	10 - 36 VDC	10 - 36 VDC
Voltage drop	≤ 2.5 VDC @ 200 mA	≤ 2.5 VDC @ 200 mA	≤ 2.5 VDC @ 200 mA	≤ 2.5 VDC @ 200 mA
Degree of protection	IP 67	IP 67	IP 67	IP 67
Protection Short-circuit (S) Reverse polarity (P) Transients (T)	SPT	SPT	SPT	SPT
Output current	≤ 200 mA @ 50°C ≤ 150 mA @ 50-70°C	≤ 200 mA @ 50°C ≤ 150 mA @ 50-70°C	≤ 200 mA @ 50°C ≤ 150 mA @ 50-70°C	≤ 200 mA @ 50°C ≤ 150 mA @ 50-70°C
Housing material	Nickel-plated brass	Nickel-plated brass	Nickel-plated brass	Nickel-plated brass
Operating temperature	-25°C to +70°C	-25°C to +70°C	-25°C to +70°C	-25°C to +70°C
LED colour	Yellow	Yellow	Yellow	Yellow
Approvals/Marks	CE - UL	CE - UL	CE - UL	CE - UL

## Inductive proximity sensors, 3-wire, DC, extended range

Types	M18 Extended - Short body		M18 Extended - Long body	
Connections	2 m cable	M12 connector	2 m cable	M12 connector
<b>Flush mountable</b>				
Dimensions (mm)	M18 x 53	M18 x 54	M18 x 73	M18 x 74
Thread (mm)	M18 x 1 x 30	M18 x 1 x 30	M18 x 1 x 50	M18 x 1 x 50
Operating frequency	1.5 kHz	1.5 kHz	1.5 kHz	1.5 kHz
Sensing distance (Sn)	8 mm	8 mm	8 mm	8 mm
<b>References</b>				
NPN-NO	ICB18S30F08NO	ICB18S30F08NOM1	ICB18L50F08NO	ICB18L50F08NOM1
PNP-NO	ICB18S30F08PO	ICB18S30F08POM1	ICB18L50F08PO	ICB18L50F08POM1
NPN-NC	ICB18S30F08NC	ICB18S30F08NCM1	ICB18L50F08NC	ICB18L50F08NCM1
PNP-NC	ICB18S30F08PC	ICB18S30F08PCM1	ICB18L50F08PC	ICB18L50F08PCM1
<b>Non-flush mountable</b>				
Dimensions (mm)	M18 x 63	M18 x 64	M18 x 83	M18 x 74
Thread (mm)	M18 x 1 x 30	M18 x 1 x 30	M18 x 1 x 50	M18 x 1 x 50
Operating frequency	1.5 kHz	1.5 kHz	1.5 kHz	1.5 kHz
Sensing distance (Sn)	14 mm	14 mm	14 mm	14 mm
<b>References</b>				
NPN-NO	ICB18S30N14NO	ICB18S30N14NOM1	ICB18L50N14NO	ICB18L50N14NOM1
PNP-NO	ICB18S30N14PO	ICB18S30N14POM1	ICB18L50N14PO	ICB18L50N14POM1
NPN-NC	ICB18S30N14NC	ICB18S30N14NCM1	ICB18L50N14NC	ICB18L50N14NCM1
PNP-NC	ICB18S30N14PC	ICB18S30N14PCM1	ICB18L50N14PC	ICB18L50N14PCM1
<b>Characteristics flush and non-flush mountable</b>				
Rated operating voltage	10 - 36 VDC	10 - 36 VDC	10 - 36 VDC	10 - 36 VDC
Voltage drop	≤ 2.5 VDC @ 200 mA	≤ 2.5 VDC @ 200 mA	≤ 2.5 VDC @ 200 mA	≤ 2.5 VDC @ 200 mA
Degree of protection	IP 67	IP 67	IP 67	IP 67
Protection Short-circuit (S) Reverse polarity (P) Transients (T)	SPT	SPT	SPT	SPT
Output current	≤ 200 mA @ 50°C ≤ 150 mA @ 50-70°C	≤ 200 mA @ 50°C ≤ 150 mA @ 50-70°C	≤ 200 mA @ 50°C ≤ 150 mA @ 50-70°C	≤ 200 mA @ 50°C ≤ 150 mA @ 50-70°C
Housing material	Nickel-plated brass	Nickel-plated brass	Nickel-plated brass	Nickel-plated brass
Operating temperature	-25°C to +70°C	-25°C to +70°C	-25°C to +70°C	-25°C to +70°C
LED colour	Yellow	Yellow	Yellow	Yellow
Approvals/Marks	CE - UL	CE - UL	CE - UL	CE - UL





## Inductive proximity sensors, 3-wire, DC





Types	M30 Standard - Short body		M30 Standard - Long body	
	2 m cable	M12 connector	2 m cable	M12 connector
<b>Flush mountable</b>				
Dimensions (mm)	M30 x 43.6	M30 x 55	M30 x 63.6	M30 x 75
Thread (mm)	M30 x 1.5 x 30	M30 x 1.5 x 30	M30 x 1.5 x 50	M30 x 1.5 x 50
Operating frequency	1 kHz	1 kHz	1 kHz	1 kHz
Sensing distance (Sn)	10 mm	10 mm	10 mm	10 mm
<b>References</b>				
NPN-NO	ICB30SF10NO	ICB30SF10NOM1	ICB30LF10NO	ICB30LF10NOM1
PNP-NO	ICB30SF10PO	ICB30SF10POM1	ICB30LF10PO	ICB30LF10POM1
NPN-NC	ICB30SF10NC	ICB30SF10NCM1	ICB30LF10NC	ICB30LF10NCM1
PNP-NC	ICB30SF10PC	ICB30SF10PCM1	ICB30LF10PC	ICB30LF10PCM1

<b>Non-flush mountable</b>				
Dimensions (mm)	M30 x 55.6	M30 x 67	M30 x 75.6	M30 x 87
Thread (mm)	M30 x 1.5 x 30	M30 x 1.5 x 30	M30 x 1.5 x 30	M30 x 1.5 x 30
Operating frequency	1 kHz	1 kHz	1 kHz	1 kHz
Sensing distance (Sn)	15 mm	15 mm	15 mm	15 mm
<b>References</b>				
NPN-NO	ICB30SN15NO	ICB30SN15NOM1	ICB30LN15NO	ICB30LN15NOM1
PNP-NO	ICB30SN15PO	ICB30SN15POM1	ICB30LN15PO	ICB30LN15POM1
NPN-NC	ICB30SN15NC	ICB30SN15NCM1	ICB30LN15NC	ICB30LN15NCM1
PNP-NC	ICB30SN15PC	ICB30SN15PCM1	ICB30LN15PC	ICB30LN15PCM1

<b>Characteristics flush and non-flush mountable</b>				
Rated operating voltage	10 - 36 VDC	10 - 36 VDC	10 - 36 VDC	10 - 36 VDC
Voltage drop	≤ 2.5 VDC @ 200 mA	≤ 2.5 VDC @ 200 mA	≤ 2.5 VDC @ 200 mA	≤ 2.5 VDC @ 200 mA
Degree of protection	IP 67	IP 67	IP 67	IP 67
Protection Short-circuit (S) Reverse polarity (P) Transients (T)	SPT	SPT	SPT	SPT
Output current	≤ 200 mA @ 50°C ≤ 150 mA @ 50-70°C	≤ 200 mA @ 50°C ≤ 150 mA @ 50-70°C	≤ 200 mA @ 50°C ≤ 150 mA @ 50-70°C	≤ 200 mA @ 50°C ≤ 150 mA @ 50-70°C
Housing material	Nickel-plated brass	Nickel-plated brass	Nickel-plated brass	Nickel-plated brass
Operating temperature	-25°C to +70°C	-25°C to +70°C	-25°C to +70°C	-25°C to +70°C
LED colour	Yellow	Yellow	Yellow	Yellow
Approvals/Marks	CE - UL - CSA	CE - UL - CSA	CE - UL - CSA	CE - UL - CSA



# Inductive proximity sensors, 3-wire, DC, extended range

Types	M30 Extended - Short body		M30 Extended - Long body	
Connections	2 m cable	M12 connector	2 m cable	M12 connector
<b>Flush mountable</b>				
Dimensions (mm)	M30 x 43.6	M30 x 55	M30 x 63.6	M30 x 75
Thread (mm)	M30 x 1.5 x 30	M30 x 1.5 x 30	M30 x 1.5 x 30	M30 x 1.5 x 30
Operating frequency	1 kHz	1 kHz	1 kHz	1 kHz
Sensing distance (Sn)	15 mm	15 mm	15 mm	15 mm
<b>References</b>				
NPN-NO	ICB30SF15NO	ICB30SF15NOM1	ICB30LF15NO	ICB30LF15NOM1
PNP-NO	ICB30SF15PO	ICB30SF15POM1	ICB30LF15PO	ICB30LF15POM1
NPN-NC	ICB30SF15NC	ICB30SF15NCM1	ICB30LF15NC	ICB30LF15NCM1
PNP-NC	ICB30SF15PC	ICB30SF15PCM1	ICB30LF15PC	ICB30LF15PCM1

<b>Non-flush mountable</b>				
Dimensions (mm)	M30 x 55.6	M30 x 67	M30 x 75.6	M30 x 87
Thread (mm)	M30 x 1.5 x 30	M30 x 1.5 x 30	M30 x 1.5 x 50	M30 x 1.5 x 50
Operating frequency	1 kHz	1 kHz	1 kHz	1 kHz
Sensing distance (Sn)	22 mm	22 mm	22 mm	22 mm
<b>References</b>				
NPN-NO	ICB30SN22NO	ICB30SN22NOM1	ICB30LN22NO	ICB30LN22NOM1
PNP-NO	ICB30SN22PO	ICB30SN22POM1	ICB30LN22PO	ICB30LN22POM1
NPN-NC	ICB30SN22NC	ICB30SN22NCM1	ICB30LN22NC	ICB30LN22NCM1
PNP-NC	ICB30SN22PC	ICB30SN22PCM1	ICB30LN22PC	ICB30LN22PCM1

<b>Characteristics flush and non-flush mountable</b>				
Rated operating voltage	10 - 36 VDC	10 - 36 VDC	10 - 36 VDC	10 - 36 VDC
Voltage drop	≤ 2.5 VDC @ 200 mA	≤ 2.5 VDC @ 200 mA	≤ 2.5 VDC @ 200 mA	≤ 2.5 VDC @ 200 mA
Degree of protection	IP 67	IP 67	IP 67	IP 67
Protection Short-circuit (S) Reverse polarity (P) Transients (T)	SPT	SPT	SPT	SPT
Output current	≤ 200 mA @ 50°C ≤ 150 mA @ 50-70°C	≤ 200 mA @ 50°C ≤ 150 mA @ 50-70°C	≤ 200 mA @ 50°C ≤ 150 mA @ 50-70°C	≤ 200 mA @ 50°C ≤ 150 mA @ 50-70°C
Housing material	Nickel-plated brass	Nickel-plated brass	Nickel-plated brass	Nickel-plated brass
Operating temperature	-25°C to +70°C	-25°C to +70°C	-25°C to +70°C	-25°C to +70°C
LED colour	Yellow	Yellow	Yellow	Yellow
Approvals/Marks	CE - UL - CSA	CE - UL - CSA	CE - UL - CSA	CE - UL - CSA

## Inductive proximity sensors, 3-wire, DC



Types	M5 Standard - Short body		M8 Standard - Short body	
Connections	2 m cable	M8 connector	2 m cable	M8 connector
<b>Flush mountable</b>				
Dimensions (mm)	M5 x 26.5	M5 x 40	M8 x 30	M8 x 45
Thread (mm)	M5 x 1 x 20.5	M5 x 1 x 21	M8 x 1 x 30	M8 x 1 x 25
Operating frequency	2 kHz	2 kHz	2 kHz	2 kHz
Sensing distance (Sn)	1 mm (0.8 mm for IA05BSF10NCP)	1 mm	1.5 mm	1.5 mm
<b>References</b>				
NPN-NO	IA05BSF10NOP	IA05BSF10NOM5P	IA08BSF15NO	IA08BSF15NOM5
PNP-NO	IA05BSF10POP	IA05BSF10POM5P	IA08BSF15PO	IA08BSF15POM5
NPN-NC	IA05BSF10NCP	IA05BSF10NCM5P	IA08BSF15NC	IA08BSF15NCM5
PNP-NC	IA05BSF10PCP	IA05BSF10PCM5P	IA08BSF15PC	IA08BSF15PCM5
<b>Non-flush mountable</b>				
Dimensions (mm)			M8 x 30	M8 x 45
Thread (mm)			M8 x 1 x 27	M8 x 1 x 22
Operating frequency			2 kHz	2 kHz
Sensing distance (Sn)			2.5 mm	2.5 mm
<b>References</b>				
NPN-NO			IA08BSN25NO	IA08BSN25NOM5
PNP-NO			IA08BSN25PO	IA08BSN25POM5
NPN-NC			IA08BSN25NC	IA08BSN25NCM5
PNP-NC			IA08BSN25PC	IA08BSN25PCM5
<b>Characteristics flush and non-flush mountable</b>				
Rated operating voltage	10 - 30 VDC	10 - 30 VDC	10 - 30 VDC	10 - 30 VDC
Voltage drop	< 1.0 VDC (@ I <sub>max</sub> )	< 1.0 VDC (@ I <sub>max</sub> )	≤ 2.5 VDC (@ I <sub>max</sub> )	≤ 2.5 VDC (@ I <sub>max</sub> )
Degree of protection	IP 67	IP 67	IP 67	IP 67
Protection Short-circuit (S)			SP	SP
Reverse polarity (P)			SP	SP
Transients (T)			SP	SP
Output current	≤ 200 mA	≤ 200 mA	≤ 200 mA @ 25°C	≤ 200 mA @ 25°C
Housing material	Stainless steel	Stainless steel	Stainless steel	Stainless steel
Operating temperature	-25°C to +70°C	-25°C to +70°C	-25°C to +70°C	-25°C to +70°C
LED colour	Yellow	Yellow	Yellow	Yellow
Approvals/Marks	CE	CE	CE - UL - CSA	CE - UL - CSA

# Inductive proximity sensors, 3-wire, DC

Types	M8 Standard - Long body		
Connections	2 m cable	M8 connector	M12 connector
<b>Flush mountable</b>			

Dimensions (mm)	M8 x 45	M8 x 60	M12 x 70
Thread (mm)	M8 x 1 x 45	M8 x 1 x 40	M12 x 1 x 43
Operating frequency	2 kHz	2 kHz	2 kHz
Sensing distance (Sn)	1.5 mm	1.5 mm	1.5 mm

References			
NPN-NO	IA08BLF15NO	IA08BLF15NOM5	IA08BLF15NOM1
PNP-NO	IA08BLF15PO	IA08BLF15POM5	IA08BLF15POM1
NPN-NC	IA08BLF15NC	IA08BLF15NCM5	IA08BLF15NCM1
PNP-NC	IA08BLF15PC	IA08BLF15PCM5	IA08BLF15PCM1

<b>Non-flush mountable</b>			
----------------------------	--	---	--

Dimensions (mm)	M8 x 45	M8 x 60	M12 x 70
Thread (mm)	M8 x 1 x 42	M12 x 1 x 37	M8 x 1 x 40
Operating frequency	2 kHz	2 kHz	2 kHz
Sensing distance (Sn)	2.5 mm	2.5 mm	2.5 mm

References			
NPN-NO	IA08BLN25NO	IA08BLN25NOM5	IA08BLN25NOM1
PNP-NO	IA08BLN25PO	IA08BLN25POM5	IA08BLN25POM1
NPN-NC	IA08BLN25NC	IA08BLN25NCM5	IA08BLN25NCM1
PNP-NC	IA08BLN25PC	IA08BLN25PCM5	IA08BLN25PCM1

## Characteristics flush and non-flush mountable

Rated operating voltage	10 - 30 VDC	10 - 30 VDC	10 - 30 VDC
Voltage drop	≤ 2.5 VDC (@ I <sub>max</sub> )	≤ 2.5 VDC (@ I <sub>max</sub> )	≤ 2.5 VDC (@ I <sub>max</sub> )
Degree of protection	IP 67	IP 67	IP 67
Protection Short-circuit (S) Reverse polarity (P) Transients (T)	S	S	S
Output current	< 200 mA @ 25°C	< 200 mA @ 25°C	< 200 mA @ 25°C
Housing material	Stainless steel	Stainless steel	Stainless steel
Operating temperature	-25°C to +70°C	-25°C to +70°C	-25°C to +70°C
LED colour	Yellow	Yellow	Yellow
Approvals/Marks	CE - UL - CSA	CE - UL - CSA	CE - UL - CSA

# Inductive proximity sensors, 3-wire, DC, extended range

## Types M8 Extended - Short body

### Connections 2 m cable M8 connector

#### Flush mountable



Dimensions (mm)	M8 x 35	M8 x 50
Thread (mm)	M8 x 1 x 35	M8 x 1 x 30
Operating frequency	2 kHz	2 kHz
Sensing distance (Sn)	2 mm	2 mm

#### References

NPN-NO	IA08BSF20NO	IA08BSF20NOM5
PNP-NO	IA08BSF20PO	IA08BSF20POM5
NPN-NC	IA08BSF20NC	IA08BSF20NCM5
PNP-NC	IA08BSF20PC	IA08BSF20PCM5

#### Non-flush mountable



Dimensions (mm)	M8 x 35	M8 x 50
Thread (mm)	M8 x 1 x 32	M8 x 1 x 27
Operating frequency	1 kHz	1 kHz
Sensing distance (Sn)	4 mm	4 mm

#### References



NPN-NO	IA08BSN40NO	IA08BSN40NOM5
PNP-NO	IA08BSN40PO	IA08BSN40POM5
NPN-NC	IA08BSN40NC	IA08BSN40NCM5
PNP-NC	IA08BSN40PC	IA08BSN40PCM5

#### Characteristics flush and non-flush mountable

Rated operating voltage	10 - 30 VDC	10 - 30 VDC
Voltage drop	≤ 2.5 VDC @ 200 mA	≤ 2.5 VDC @ 200 mA
Degree of protection	IP 67	IP 67
Protection Short-circuit (S) Reverse polarity (P) Transients (T)	SPT	SPT
Output current	< 200 mA @ 25°C	< 200 mA @ 25°C
Housing material	Stainless steel	Stainless steel
Operating temperature	-25°C to +70°C	-25°C to +70°C
LED colour	Yellow	Yellow
Approvals/Marks	CE - UL - CSA	CE - UL - CSA

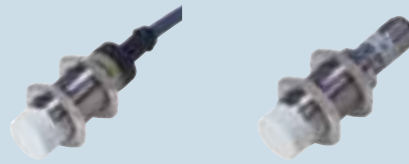

## Inductive proximity sensors, 3-wire, DC

Types	M18 Standard - Short body		M18 Standard - Long body	
Connections	2 m cable	M12 connector	2 m cable	M12 connector
<b>Flush mountable</b>				
Dimensions (mm)	M18 x 41.6	M18 x 55	M18 x 61.6	M18 x 75
Thread (mm)	M18 x 1 x 30	M18 x 1 x 30	M18 x 1 x 50	M18 x 1 x 50
Operating frequency	1.5 kHz	1.5 kHz	1.5 kHz	1.5 kHz
Sensing distance (Sn)	5 mm	5 mm	5 mm	5 mm
<b>References</b>				
NPN-NO	IA18DSF05NO	IA18ASF05NOM1		
PNP-NO	IA18DSF05PO	IA18ASF05POM1	IA18DLF05PO	IA18ALF05POM1
NPN-NC	IA18DSF05NC	IA18ASF05NCM1		
PNP-NC	IA18DSF05PC	IA18ASF05PCM1	IA18DLF05PC	IA18ALF05PCM1
<b>Non-flush mountable</b>				
Dimensions (mm)	M18 x 49.6	M18 x 63		
Thread (mm)	M18 x 1 x 30	M18 x 1 x 30		
Operating frequency	1.5 kHz	1.5 kHz		
Sensing distance (Sn)	8 mm	8 mm		
<b>References</b>				
NPN-NO	IA18DSN08NO	IA18ASN08NOM1		
PNP-NO	IA18DSN08PO	IA18ASN08POM1		
NPN-NC	IA18DSN08NC	IA18ASN08NCM1		
PNP-NC	IA18DSN08PC	IA18ASN08PCM1		
<b>Characteristics flush and non-flush mountable</b>				
Rated operating voltage	10 - 40 VDC	10 - 40 VDC	10 - 40 VDC	10 - 40 VDC
Voltage drop	≤ 2.5 VDC	≤ 2.5 VDC	≤ 2.5 VDC	≤ 2.5 VDC
Degree of protection	IP 67	IP 67	IP 67	IP 67
Protection Short-circuit (S) Reverse polarity (P) Transients (T)	SPT	SPT	SPT	SPT
Output current	< 200 mA @ 50°C	< 200 mA @ 50°C	< 200 mA @ 50°C	< 200 mA @ 50°C
Housing material	Nickel-plated brass + plastic	Nickel-plated brass	Nickel-plated brass + plastic	Nickel-plated brass
Operating temperature	-25°C to +70°C	-25°C to +70°C	-25°C to +70°C	-25°C to +70°C
LED colour	Yellow	Yellow	Yellow	Yellow
Approvals/Marks	CE - UL - CSA	CE - UL - CSA	CE - UL - CSA	CE - UL - CSA

## Inductive proximity sensors, 3-wire, DC

Types	M30 Standard - Short body		M30 Standard - Long body	
Connections	2 m cable	M12 connector	2 m cable	M12 connector
<b>Flush mountable</b>				
Dimensions (mm)	M30 x 43.6	M30 x 55	M30 x 63.6	M30 x 75
Thread (mm)	M30 x 1.5 x 30	M30 x 1.5 x 30	M30 x 1.5 x 50	M30 x 1.5 x 50
Operating frequency	700 Hz	700 Hz	700 Hz	700 Hz
Sensing distance (Sn)	10 mm	10 mm	10 mm	10 mm
<b>References</b>				
NPN-NO	<b>IA30DSF10NO</b>	<b>IA30ASF10NOM1</b>		
PNP-NO	<b>IA30DSF10PO</b>	<b>IA30ASF10POM1</b>	<b>IA30DLF10PO</b>	<b>IA30ALF10POM1</b>
NPN-NC				
PNP-NC			<b>IA30DLF10PC</b>	
<b>Non-flush mountable</b>				
Dimensions (mm)	M30 x 55.6	M30 x 67		
Thread (mm)	M30 x 1.5 x 30	M30 x 1.5 x 30		
Operating frequency	700 Hz	700 Hz		
Sensing distance (Sn)	15 mm	15 mm		
<b>References</b>				
NPN-NO	<b>IA30DSN15NO</b>	<b>IA30ASN15NOM1</b>		
PNP-NO	<b>IA30DSN15PO</b>	<b>IA30ASN15POM1</b>		
NPN-NC				
PNP-NC				
<b>Characteristics flush and non-flush mountable</b>				
Rated operating voltage	10 - 40 VDC	10 - 40 VDC	10 - 40 VDC	10 - 40 VDC
Voltage drop	≤ 2.5 VDC	≤ 2.5 VDC	≤ 2.5 VDC	≤ 2.5 VDC
Degree of protection	IP 67	IP 67	IP 67	IP 67
Protection Short-circuit (S)				
Reverse polarity (P)	SPT	SPT	SPT	SPT
Transients (T)				
Output current	< 200 mA @ 50°C	< 200 mA @ 50°C	< 200 mA @ 50°C	< 200 mA @ 50°C
Housing material	Nickel-plated brass + plastic	Nickel-plated brass	Nickel-plated brass + plastic	Nickel-plated brass
Operating temperature	-25°C to +70°C	-25°C to +70°C	-25°C to +70°C	-25°C to +70°C
LED colour	Yellow	Yellow	Yellow	Yellow
Approvals/Marks	CE - UL - CSA	CE - UL - CSA	CE - UL - CSA	CE - UL - CSA

# Inductive proximity sensors, 3-wire, DC, extended range

Types	M18 Extended - Short body		M30 Extended - Short body	
Connections	2 m cable	M12 connector	2 m cable	M12 connector



Dimensions (mm)	M18 x 41.6	M18 x 55	M30 x 43.6	M30 x 55
Thread (mm)	M18 x 1 x 30	M18 x 1 x 30	M30 x 1.5 x 30	M30 x 1.5 x 50
Operating frequency	1400 Hz	1400 Hz	700 Hz	700 Hz
Sensing distance (Sn)	8 mm	8 mm	15 mm	15 mm

**References**

NPN-NO	IA18DSF08NO	IA18ASF08NOM1	IA30DSF15NO	IA30ASF15NOM1
PNP-NO	IA18DSF08PO	IA18ASF08POM1	IA30DSF15PO	IA30ASF15POM1
NPN-NC				
PNP-NC			IA30DSF15PC	



Dimensions (mm)	M18 x 49.6	M18 x 63	M30 x 55.6	M30 x 67
Thread (mm)	M18 x 1 x 30	M18 x 1 x 30	M30 x 1.5 x 30	M30 x 1.5 x 30
Operating frequency	700 Hz	700 Hz	500 Hz	500 Hz
Sensing distance (Sn)	14 mm	14 mm	22 mm	22 mm





**References**



NPN-NO	IA18DSN14NO	IA18ASN14NOM1	IA30DSN22NO	IA30ASN22NOM1
PNP-NO	IA18DSN14PO	IA18ASN14POM1	IA30DSN22PO	IA30ASN22POM1

**Characteristics flush and non-flush mountable**





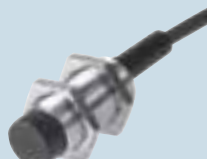



Rated operating voltage	10 - 40 VDC	10 - 40 VDC	10 - 40 VDC	10 - 40 VDC
Voltage drop	≤ 2.5 VDC	≤ 2.5 VDC	≤ 2.5 VDC	≤ 2.5 VDC
Degree of protection	IP 67	IP 67	IP 67	IP 67
Protection Short-circuit (S) Reverse polarity (P) Transients (T)	SPT	SPT	SPT	SPT
Output current	< 200 mA @ 50°C	< 200 mA @ 50°C	< 200 mA @ 50°C	< 200 mA @ 50°C
Housing material	Stainless steel	Stainless steel	Nickel-plated brass + plastic	Nickel-plated brass
Operating temperature	-25°C to +70°C	-25°C to +70°C	-25°C to +70°C	-25°C to +70°C
LED colour	Yellow	Yellow	Yellow	Yellow
Approvals/Marks	CE - UL - CSA	CE - UL - CSA	CE - UL - CSA	CE - UL - CSA

## Inductive proximity sensors, high temperature

Types	M5	M8	M12	
Connections	2 m cable	2 m cable	2 m cable or M12 connector	
Flush or non-flush mountable				
Dimensions (mm)	M5 x 30	M8 x 45	M12 x 40	M12 x 40
Thread (mm)	M5 x 0.5 x 25	M8 x 1 x 40	M12 x 1 x 40	M12 x 1 x 34
Sensing distance (Sn)	0.8 mm	1 mm	2 mm	4 mm
Output	≤ 5 mA	≤ 5 mA	≤ 20 mA	≤ 20 mA
<b>References</b>				
NPN-NO Cable	<b>IA05BSF08NOHT-K</b>	<b>IA08BSF10NOHT-K</b>		
PNP-NO Cable	<b>IA05BSF08POHT-K</b>	<b>IA08BSF10POHT-K</b>	<b>IA12ASF02POHT-K</b>	<b>IA12ASN04POHT-K</b>
PNP-NO Plug			<b>IA12ASF02POM1HT-K</b>	<b>IA12ASN04POM1HT-K</b>
<b>Specifications</b>				
Rated operating voltage	10 - 30 VDC	10 - 30 VDC	10 - 30 VDC	10 - 30 VDC
Degree of protection	IP 67	IP 67	IP 67	IP 67
Protection	Short-circuit, reverse polarity	Short-circuit, reverse polarity	Short-circuit	Short-circuit
Housing material	Stainless steel	Stainless steel	Nickel-plated brass	Nickel-plated brass
Operating temperature	-25°C to +120°C	-25°C to +120°C	-40°C to +100°C	-40°C to +100°C
Approvals/Marks	CE	CE	CE	CE

Types	M18		M30	
Connections	2 m cable or M12 connector		2 m cable or M12 connector	
Flush or non-flush mountable				
Dimensions (mm)	M18 x 40	M18 x 40	M30 x 40	M30 x 40
Thread (mm)	M18 x 1 x 40	M18 x 1 x 32	M30 x 1.5 x 40	M30 x 1.5 x 28
Sensing distance (Sn)	5 mm	8 mm	10 mm	15 mm
Output	≤ 25 mA	≤ 25 mA	≤ 25 mA	≤ 25 mA
<b>References</b>				
PNP-NO Cable	<b>IA18ASF05POHT-K</b>	<b>IA18ASN08POHT-K</b>	<b>IA30ASF10POHT-K</b>	<b>IA30ASN15POHT-K</b>
PNP-NO Plug	<b>IA18ASF05POM1HT-K</b>	<b>IA18ASN08POM1HT-K</b>	<b>IA30ASF10POM1HT-K</b>	<b>IA30ASN15POM1HT-K</b>
<b>Characteristics flush and non-flush mountable</b>				
Rated operating voltage	10 - 30 VDC	10 - 30 VDC	10 - 30 VDC	10 - 30 VDC
Degree of protection	IP 67	IP 67	IP 67	IP 67
Protection	Short-circuit	Short-circuit	Short-circuit	Short-circuit
Housing material	Nickel-plated brass	Nickel-plated brass	Nickel-plated brass	Nickel-plated brass
Operating temperature	-40°C to +100°C	-40°C to +100°C	-40°C to +100°C	-40°C to +100°C
Approvals/Marks	CE	CE	CE	CE

# Inductive proximity sensors, NAMUR, DC

Types	M12		M18	
Housing	Steel	Plastic	Steel	Plastic
<b>Flush mountable</b>				
Dimensions short body (mm)	M12 x 1 x 30	M12 x 1 x 30	M18 x 1 x 30	M18 x 1 x 30
Dimensions long body (mm)	M12 x 1 x 50	M12 x 1 x 50	M18 x 1 x 50	M18 x 1 x 50
Thread (mm)	M12 x 1	M12 x 1	M18 x 1	M18 x 1
Operating frequency	1.4 kHz	1.4 kHz	500 Hz	500 Hz
Sensing distance (Sn)	2 mm	2 mm	5 mm	5 mm
<b>References</b>				
Short body cable	IA12ESF02UC	IA12CSF02UC	IA18ESF05UC	IA18CSF05UC
Long body cable	IA12ELF02UC	IA12CLF02UC	IA18ELF05UC	IA18CLF05UC
Short body plug	IA12ESF02UCM1	IA12CSF02UCM1	IA18ESF05UCM1	IA18CSF05UCM1
Long body plug	IA12ELF02UCM1	IA12CLF02UCM1	IA18ELF05UCM1	IA18CLF05UCM1
<b>Non-flush mountable</b>				
Dimensions short body (mm)	M12 x 1 x 30	M12 x 1 x 30	M18 x 1 x 30	M18 x 1 x 30
Dimensions long body (mm)	M12 x 1 x 50	M12 x 1 x 50	M18 x 1 x 50	M18 x 1 x 50
Thread (mm)	M12 x 1	M12 x 1	M18 x 1	M18 x 1
Operating frequency	1.2 kHz	1.2 kHz	200 Hz	200 Hz
Sensing distance (Sn)	4 mm	4 mm	8 mm	8 mm
<b>References</b>				
Short body cable	IA12ESN04UC	IA12CSN04UC	IA18ESN08UC	IA18CSN08UC
Long body cable	IA12ELN04UC	IA12CLN04UC	IA18ELN08UC	IA18CLN08UC
Short body plug	IA12ESN04UCM1	IA12CSN04UCM1	IA18ESN08UCM1	IA18CSN08UCM1
Long body plug	IA12ELN04UCM1	IA12CLN04UCM1	IA18ELN08UCM1	IA18CLN08UCM1
<b>Characteristics flush and non-flush mountable</b>				
Rated operating voltage	7 - 9 VDC	7 - 9 VDC	7 - 9 VDC	7 - 9 VDC
Degree of protection	IP 67	IP 67	IP 67	IP 67
Housing material	Stainless steel	Thermoplastic polyester	Stainless steel	Thermoplastic polyester
Operating temperature	-25°C to +70°C	-25°C to +70°C	-25°C to +70°C	-25°C to +70°C
LED colour	Yellow	Yellow	Yellow	Yellow
Approvals/Marks	CE - UL - CSA	CE - UL - CSA	CE - UL - CSA	CE - UL - CSA

## Inductive proximity sensors, NAMUR, DC

**Types** **M30**

**Housing** **Steel** **Plastic**

**Flush mountable**



Dimensions short body (mm)	M30 x 1.5 x 30	M30 x 1.5 x 30
Dimensions long body (mm)	M30 x 1.5 x 50	M30 x 1.5 x 50
Thread (mm)	M30 x 1	M30 x 1
Operating frequency	300 Hz	300 Hz
Sensing distance (Sn)	10 mm	10 mm

**References**

Short body cable	<b>IA30ESF10UC</b>	<b>IA30CSF10UC</b>
Long body cable	<b>IA30ELF10UC</b>	<b>IA30CLF10UC</b>
Short body plug	<b>IA30ESF10UCM1</b>	<b>IA30CSF10UCM1</b>
Long body plug	<b>IA30ELF10UCM1</b>	<b>IA30CLF10UCM1</b>

**Non-flush mountable**



Dimensions short body (mm)	M30 x 1.5 x 30	M30 x 1.5 x 30
Dimensions long body (mm)	M30 x 1.5 x 50	M30 x 1.5 x 50
Thread (mm)	M30 x 1.5	M30 x 1.5
Operating frequency	100 Hz	100 Hz
Sensing distance (Sn)	15 mm	15 mm







**References**

Short body cable	<b>IA30ESN15UC</b>	<b>IA30CSN15UC</b>
Long body cable	<b>IA30ELN15UC</b>	<b>IA30CLN15UC</b>
Short body plug	<b>IA30ESN15UCM1</b>	<b>IA30CSN15UCM1</b>
Long body plug	<b>IA30ELN15UCM1</b>	<b>IA30CLN15UCM1</b>





**Characteristics flush and non-flush mountable**

Rated operating voltage	7 - 9 VDC	7 - 9 VDC
Degree of protection	IP 67	IP 67
Housing material	Stainless steel	Thermoplastic polyester
Operating temperature	-25°C to +70°C	-25°C to +70°C
LED colour	Yellow	Yellow
Approvals/Marks	CE - UL - CSA	CE - UL - CSA

# Inductive proximity sensors, 2-wire, DC, extended range

Types	M8 Extended Short body	M12 Extended - Short body	
Connections	2 m cable	2 m cable	M12 connector
<b>Flush mountable</b>			
Dimensions (mm)	M8 x 30	M12 x 49	M12 x 63
Thread (mm)	M8 x 1 x 30	M12 x 1 x 38	M12 x 1 x 38
Operating frequency	2 kHz	1 kHz	1 kHz
Sensing distance (Sn)	2 mm	4 mm	4 mm
<b>References</b>			
NO	IA08BSF02DO	IA12DSF04DO	IA12ASF04DOM1
NC	IA08BSF02DC	IA12DSF04DC	IA12ASF04DCM1
<b>Non-flush mountable</b>			
Dimensions (mm)	M8 x 30	M12 x 53	M12 x 67
Thread (mm)	M8 x 1 x 26	M12 x 1 x 38	M12 x 1 x 38
Operating frequency	2 kHz	800 Hz	800 Hz
Sensing distance (Sn)	4 mm	8 mm	8 mm
<b>References</b>			
NO	IA08BSN04DO	IA12DSN08DO	IA12ASN08DOM1
NC	IA08BSN04DC	IA12DSN08DC	IA12ASN08DCM1
<b>Characteristics flush and non-flush mountable</b>			
Rated operating voltage	10 - 30 VDC	10 - 40 VDC	10 - 40 VDC
Voltage drop	≤ 8 VDC @ max. load	≤ 3 VDC @ max. load	≤ 3 VDC @ max. load
Degree of protection	IP 67	IP 67	IP 67
Protection Short-circuit (S) Reverse polarity (P) Transients (T)	SPT	SPT	SPT
Output current	3 - 100 mA	5 - 100 mA	5 - 100 mA
Housing material	Stainless steel	Nickel-plated brass	Nickel-plated brass
Operating temperature	-25°C to +70°C	-25°C to +70°C	-25°C to +70°C
LED colour	Yellow	Yellow	Yellow
Approvals/Marks	CE - CSA	CE - UL - CSA	CE - UL - CSA

## Inductive proximity sensors, 2-wire, DC, extended range

Types	M18 Extended - Short body		M30 Extended - Short body	
Connections	2 m cable	M18 connector	2 m cable	M18 connector
<b>Flush mountable</b>				
Dimensions (mm)	M18 x 42	M18 x 55	M30 x 44	M30 x 55
Thread (mm)	M18 x 1 x 30	M18 x 1 x 30	M30 x 1.5 x 30	M30 x 1.5 x 30
Operating frequency	500 Hz	500 Hz	400 Hz	400 Hz
Sensing distance (Sn)	8 mm	8 mm	15 mm	15 mm

### References

NO	IA18DSF08DO	IA18ASF08DOM1	IA30DSF15DO	IA30ASF15DOM1
NC	IA18DSF08DC	IA18ASF08DCM1	IA30DSF15DC	IA30ASF15DCM1

<b>Non-flush mountable</b>				
----------------------------	--	--	---	--

Dimensions (mm)	M18 x 50	M18 x 63	M30 x 56	M30 x 67
Thread (mm)	M18 x 1 x 30	M18 x 1 x 30	M30 x 1.5 x 30	M30 x 1.5 x 30
Operating frequency	400 Hz	400 Hz	200 Hz	200 Hz
Sensing distance (Sn)	14 mm	14 mm	22 mm	22 mm

### References

NO	IA18DSN14DO	IA18ASN14DOM1	IA30DSN22DO	IA30ASN22DOM1
NC	IA18DSN14DC	IA18ASN14DCM1	IA30DSN22DC	IA30ASN22DCM1

### Characteristics flush and non-flush mountable

Rated operating voltage	10 - 40 VDC	10 - 40 VDC	10 - 40 VDC	10 - 40 VDC
Voltage drop	≤ 3 VDC @ max. load	≤ 3 VDC @ max. load	≤ 3 VDC @ max. load	≤ 3 VDC @ max. load
Degree of protection	IP 67	IP 67	IP 67	IP 67
Protection Short-circuit (S) Reverse polarity (P) Transients (T)	SPT	SPT	SPT	SPT
Output current	5 - 100 mA	5 - 100 mA	5 - 100 mA	5 - 100 mA
Housing material	Nickel-plated brass	Nickel-plated brass	Nickel-plated brass	Nickel-plated brass
Operating temperature	-25°C to +70°C	-25°C to +70°C	-25°C to +70°C	-25°C to +70°C
LED colour	Yellow	Yellow	Yellow	Yellow
Approvals/Marks	CE - UL - CSA	CE - UL - CSA	CE - UL - CSA	CE - UL - CSA



# Inductive proximity sensors, 2-wire, AC

**Types** M12 Standard - Long body

**Connections** 2 m cable M12 connector

**Flush mountable**



Dimensions (mm)	M12 x 66	M12 x 74.5
Thread (mm)	M12 x 1 x 50	M12 x 1 x 50
Operating frequency	25 Hz	25 Hz
Sensing distance (Sn)	2 mm	2 mm

**References**

SCR-NO	EI1202TBOSL	EI1202TBOSL-6
SCR-NC	EI1202TBCSL	

**Non-flush mountable**



Dimensions (mm)	M12 x 70	M12 x 78.5
Thread (mm)	M12 x 1 x 50	M12 x 1 x 50
Operating frequency	25 Hz	25 Hz
Sensing distance (Sn)	4 mm	4 mm

**References**

SCR-NO	EI1204TBOSL	EI1204TBOSL-6
SCR-NC	EI1204TBCSL	

**Characteristics flush and non-flush mountable**

Rated operating voltage	20 - 265 VAC	20 - 265 VAC
Voltage drop	≤ 8 VAC	≤ 8 VAC
Degree of protection	IP 67	IP 67
Protection Short-circuit (S) Reverse polarity (P) Transients (T)	T	T
Output current	< 500 mA	< 500 mA
Housing material	Stainless steel	Stainless steel
Operating temperature	-25°C to +70°C	-25°C to +70°C
LED colour	Yellow	Yellow
Approvals/Marks	CE - UL - CSA	CE - UL - CSA

## Inductive proximity sensors, 2-wire, AC

Types	M18 Standard - Short body		M18 Standard - Long body	
Connections	2 m cable	M12 connector	2 m cable	M12 connector

### Flush mountable



Dimensions (mm)	M18 x 57	M18 x 55	M18 x 77	M18 x 75
Thread (mm)	M18 x 1 x 30	M18 x 1 x 30	M18 x 1 x 50	M18 x 1 x 50
Operating frequency	25 Hz	25 Hz	25 Hz	25 Hz
Sensing distance (Sn)	5 mm	5 mm	5 mm	5 mm

### References

SCR-NO	EI1805TBOSS	EI1805TBOSS-6	EI1805TBOSL	EI1805TBOSL-6
SCR-NC	EI1805TBCSS		EI1805TBCSL	

### Non-flush mountable



Dimensions (mm)	M18 x 65	M18 x 63	M18 x 85	M18 x 83
Thread (mm)	M18 x 1 x 30	M18 x 1 x 30	M18 x 1 x 50	M18 x 1 x 50
Operating frequency	25 Hz	25 Hz	25 Hz	25 Hz
Sensing distance (Sn)	8 mm	8 mm	8 mm	8 mm

### References

SCR-NO	EI1808TBOSS	EI1808TBOSS-6	EI1808TBOSL	EI1808TBOSL-6
SCR-NC	EI1808TBCSS		EI1808TBCSL	EI1808TBCSL-6

### Characteristics flush and non-flush mountable

Rated operating voltage	20 - 265 VAC	20 - 265 VAC	20 - 265 VAC	20 - 265 VAC
Voltage drop	≤ 8 VAC	≤ 8 VAC	≤ 8 VAC	≤ 8 VAC
Degree of protection	IP 67	IP 67	IP 67	IP 67
Protection Short-circuit (S) Reverse polarity (P) Transients (T)	T	T	T	T
Output current	< 500 mA	< 500 mA	< 500 mA	< 500 mA
Housing material	Stainless Steel	Stainless Steel	Stainless Steel	Stainless Steel
Operating temperature	-25°C to +70°C	-25°C to +70°C	-25°C to +70°C	-25°C to +70°C
LED colour	Yellow	Yellow	Yellow	Yellow
Approvals/Marks	CE - UL - CSA	CE - UL - CSA	CE - UL - CSA	CE - UL - CSA

# Inductive proximity sensors, 2-wire, AC

Types	M30 Standard - Short body		M30 Standard - Long body	
Connections	2 m cable	M12 connector	2 m cable	M12 connector

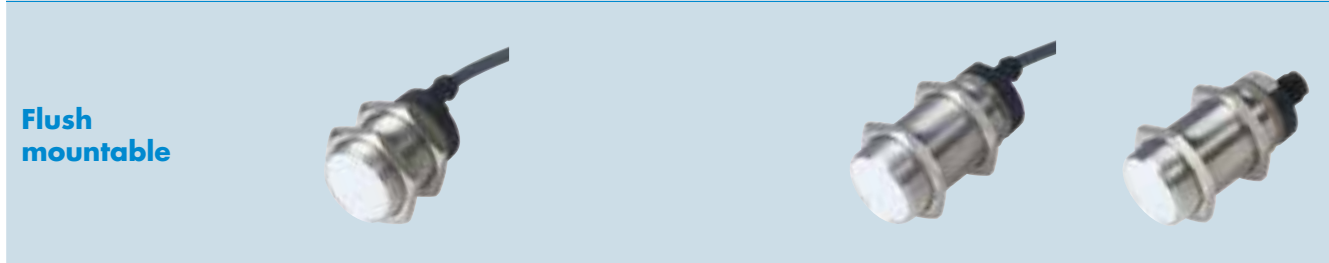

Dimensions (mm)	M30 x 59		M30 x 79	M30 x 75.5
Thread (mm)	M30 x 1.5 x 30		M30 x 1.5 x 50	M30 x 1.5 x 50
Operating frequency	25 Hz		25 Hz	25 Hz
Sensing distance (Sn)	10 mm		10 mm	10 mm

**References**

SCR-NO	EI3010TBOSS		EI3010TBOSL	EI3010TBOSL-6
SCR-NC	EI3010TBCSS		EI3010TBCSL	



Dimensions (mm)	M30 x 87.5	M30 x 67.5	M30 x 91	M30 x 71
Thread (mm)	M30 x 1.5 x 30	M30 x 1.5 x 30	M30 x 1.5 x 50	M30 x 1.5 x 50
Operating frequency	25 Hz	25 Hz	25 Hz	25 Hz
Sensing distance (Sn)	15 mm	15 mm	15 mm	15 mm







**References**

SCR-NO	EI3015TBOSS	EI3015TBOSS-6	EI3015TBOSL	EI3015TBOSL-6
SCR-NC	EI3015TBCSS		EI3015TBCSL	

**Characteristics flush and non-flush mountable**

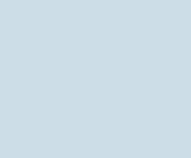
Rated operating voltage	20 - 265 VAC	20 - 265 VAC	20 - 265 VAC	20 - 265 VAC
Voltage drop	≤ 8 VAC	≤ 8 VAC	≤ 8 VAC	≤ 8 VAC
Degree of protection	IP 67	IP 67	IP 67	IP 67
Protection Short-circuit (S) Reverse polarity (P) Transients (T)	T	T	T	T
Output current	< 500 mA	< 500 mA	< 500 mA	< 500 mA
Housing material	Stainless Steel	Stainless Steel	Stainless Steel	Stainless Steel
Operating temperature	-25°C to +70°C	-25°C to +70°C	-25°C to +70°C	-25°C to +70°C
LED colour	Yellow	Yellow	Yellow	Yellow
Approvals/Marks	CE - UL - CSA	CE - UL - CSA	CE - UL - CSA	CE - UL - CSA



## Inductive proximity sensors, 2-Wire, AC

Types	M18 Standard Short body	M18 Standard - Long body		M30 Standard Long body
Connections	2 m cable	2 m cable	M12 connector	2 m cable
<b>Flush mountable</b>				
Dimensions (mm)	M18 x 57	M18 x 77		M30 x 79
Thread (mm)	M18 x 1 x 30	M18 x 1 x 50		M30 x 1.5 x 50
Operating frequency	25 Hz	25 Hz		25 Hz
Sensing distance (Sn)	5 mm	5 mm		10 mm
<b>References</b>				
SCR-NO	EI1805TBOPS	EI1805TBOPL		EI3010TBOPL
<b>Non-flush mountable</b>				
Dimensions (mm)		M18 x 85	M18 x 83	M30 x 91
Thread (mm)		M18 x 1 x 50	M18 x 1 x 50	M30 x 1.5 x 50
Operating frequency		25 Hz	25 Hz	25 Hz
Sensing distance (Sn)		8 mm	8 mm	15 mm
<b>References</b>				
SCR-NO		EI1808TBOPL		EI3015TBOPL
SCR-NC		EI1808BCPL	EI1808BCPL-6	
<b>Characteristics flush and non-flush mountable</b>				
Rated operating voltage	20 - 265 VAC	20 - 265 VAC	20 - 265 VAC	20 - 265 VAC
Voltage drop	≤ 8 VAC	≤ 8 VAC	≤ 8 VAC	≤ 8 VAC
Degree of protection	IP 67	IP 67	IP 67	IP 67
Protection Short-circuit (S)				
Reverse polarity (P)	T	T	T	T
Transients (T)				
Output current	< 500 mA	< 500 mA	< 500 mA	< 500 mA
Housing material	Thermoplastic polyester	Thermoplastic polyester	Thermoplastic polyester	Thermoplastic polyester
Operating temperature	-25°C to +70°C	-25°C to +70°C	-25°C to +70°C	-25°C to +70°C
LED colour	Yellow	Yellow	Yellow	Yellow
Approvals/Marks	CE - UL - CSA	CE - UL - CSA	CE - UL - CSA	CE - UL - CSA

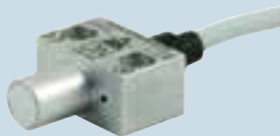

# Inductive proximity sensors, micro switch 2-wire DC

<b>Types</b>	<b>Micro switch</b>
<b>Connections</b>	<b>2 m cable</b>
	
Dimensions body (mm)	30 x 19 x 15
Thread (mm)	Ø 12 x 16
Sensing distance (Sn)	1 kHz
Output	4 mm
<b>References</b>	
NO	<b>IG12FSF04DO</b>
NC	<b>IG12FSF04DC</b>
<b>Specifications</b>	
Rated operating voltage	10 to 40 VDC
Voltage drop	≤ 3 VDC at max. load
Degree of protection	IP67
Protection Short-circuit (S)	
Reverse polarity (P)	SPT
Transients (T)	
Output current	≤ 5 - 100 mA
Housing material	Anodized Aluminium
Operating temperature	-25°C to +70°C
Approvals/Marks	CE





# Inductive proximity sensors, switch, polyester housing

Types	Transistor NPN/PNP		Power MOSFET output AC types	
Connections	Terminals		Terminals	Terminals
<b>Non-flush mountable</b>				
Dimensions (mm)	40 x 40 x 118		40 x 40 x 118	40 x 40 x 118
Operating frequency	≤ 100 Hz		≤ 25 Hz AC; 40 Hz DC	≤ 25 Hz
Sensing distance (Sn)	30 mm		30 mm	30 mm
<b>References</b>				
NPN - NO / NC	<b>IC40CNN30NAT1</b>			
PNP - NO / NC	<b>IC40CNN30PAT1</b>			
AC / DC - NO			<b>IC40CNN30COT1</b>	
AC / DC - NC			<b>IC40CNN30CCT1</b>	
AC - NO / NC				<b>IC40CNN30TAT1</b>
<b>Specifications</b>				
Rated operating voltage	10 - 30 VDC		20 - 250 VAC/DC	20 - 250 VAC
Degree of protection	IP 67		IP 67	IP 67
Protection Short-circuit (S) Reverse polarity (P) Transients (T)	SP		S	
Output current	≤ 200 mA		5 - 200 mA @ 25°C	5 - 200 mA @ 25°C
Housing material	Thermoplastic polyester		Thermoplastic polyester	Thermoplastic polyester
Operating temperature	-25°C to +70°C		-25°C to +70°C	-25°C to +70°C
LED colour	Red, green		Red, green	Red, green
Approvals/Marks	CE		CE	CE

# Inductive proximity sensors, loop detector

Types	Single loop	Dual loop
Connections	Plug 11 pin circular	Plug 11 pin circular
		
Adjustment	Auto	Auto
Manual fine-tune	Yes	Yes
Loop inductance	15-1500 $\mu$ H	15-1500 $\mu$ H
Input	1 Loop	2 Loop
Output	2 x SPDT, 1A / 250 VAC	2 x SPST, 1A / 250 VAC
<b>References</b>		
24 VAC / DC	<b>LDP1SA1BM24</b>	<b>LDP2TA2BM24</b>
115 VAC	<b>LDP1SA1B115</b>	<b>LDP2TA2B115</b>
230 VAC	<b>LDP1SA1B230</b>	<b>LDP2TA2B230</b>
<b>Specifications</b>		
Operating temperature	-40°C to +70°C	-40°C to +70°C
Mounting	11 pin circular plug	11 pin circular plug
Approvals/Marks	CE - UL	CE - UL

## Capacitive proximity sensors, TRIPLESIELD™

Types	M18-DC TRIPLESIELD™		M18-AC TRIPLESIELD™	
Connections	2 m cable	M12 connector	2 m cable	M12 connector
<b>Flush mountable</b>				
Dimensions (mm)	M18 x 71.5	M18 x 83.5	M18 x 71.5	M18 x 83.5
Thread (mm)	M18 x 1 x 46.5	M18 x 1 x 46.5	M18 x 1 x 46.5	M18 x 1 x 46.5
Operating frequency	30 Hz	30 Hz	10 Hz	10 Hz
Sensing distance (Sn)	3 - 8 mm (adjustable)	3 - 8 mm (adjustable)	3 - 8 mm (adjustable)	3 - 8 mm (adjustable)
<b>References</b>				
NPN - NO and NC	<b>CA18CLF08NA</b>	<b>CA18CLF08NAM1</b>		
PNP - NO and NC	<b>CA18CLF08PA</b>	<b>CA18CLF08PAM1</b>		
Thyristor (SCR) NO			<b>CA18CLF08TO</b>	<b>CA18CLF08TOM6</b>
Thyristor (SCR) NC			<b>CA18CLF08TC</b>	<b>CA18CLF08TCM6</b>
<b>Non-flush mountable</b>				
Dimensions (mm)	M18 x 79.5	M18 x 91.5	M18 x 79.5	M18 x 91.5
Thread (mm)	M18 x 1 x 46.5	M18 x 1 x 46.5	M18 x 1 x 46.5	M18 x 1 x 46.5
Operating frequency	30 Hz	30 Hz	10 Hz	10 Hz
Sensing distance (Sn)	3 - 12 mm (adjustable)	3 - 12 mm (adjustable)	3 - 12 mm (adjustable)	3 - 12 mm (adjustable)
<b>References</b>				
NPN - NO and NC	<b>CA18CLN12NA</b>	<b>CA18CLN12NAM1</b>		
PNP - NO and NC	<b>CA18CLN12PA</b>	<b>CA18CLN12PAM1</b>		
Thyristor (SCR) NO			<b>CA18CLN12TO</b>	<b>CA18CLN12TOM6</b>
Thyristor (SCR) NC			<b>CA18CLN12TC</b>	<b>CA18CLN12TCM6</b>
<b>Characteristics flush and non-flush mountable</b>				
Rated operating voltage	10 - 40 VDC	10 - 40 VDC	20 - 250 VAC	20 - 250 VAC
Voltage drop	≤ 2.5 VDC	≤ 2.5 VDC	≤ 10 VAC	≤ 10 VAC
Degree of protection	IP 67	IP 67	IP 67	IP 67
Protection Short-circuit (S)				
Reverse polarity (P)	SPT	SPT	T	T
Transients (T)				
Output current	< 200 mA	< 200 mA	< 500 mA	< 500 mA
Housing material	Thermoplastic polyester	Thermoplastic polyester	Thermoplastic polyester	Thermoplastic polyester
Operating temperature	-25°C to +80°C	-25°C to +80°C	-25°C to +80°C	-25°C to +80°C
LED colour	Yellow	Yellow	Yellow	Yellow
Approvals/Marks	CE - UL - CSA	CE - UL - CSA	CE - UL - CSA	CE - UL - CSA

Also available in Teflon, polypropylene and PVC housing.



## Capacitive proximity sensors, TRIPLESIELD™

Types	M18-DC TRIPLESIELD™ Flush mountable		M18-DC TRIPLESIELD™ Non-flush mountable	
	2 m cable	M12 connector	2 m cable	M12 connector
Connections	2 m cable	M12 connector	2 m cable	M12 connector
				
Dimensions (mm)	M30 x 70	M30 x 85	M30 x 70	M30 x 85
Thread (mm)	M18 x 1.0 x 55	M18 x 1.0 x 55	M18 x 1.0 x 55	M18 x 1.0 x 55
Operating frequency	50 Hz	50 Hz	50 Hz	50 Hz
Sensing distance (Sn)	2 - 10 mm (adjustable)	2 - 10 mm (adjustable)	3 - 15 mm (adjustable)	3 - 15 mm (adjustable)
<b>References</b>				
Standard				
NPN - NO and NC	CA18CAF08NA	CA18CAF08NAM1	CA18CAN12NA	CA18CAN12NAM1
PNP - NO and NC	CA18CAF08PA	CA18CAF08PAM1	CA18CAN12PA	CA18CAN12PAM1
Dust alarm				
PNP - NO	CA18CAF08PODU		CA18CAN12PODU	
PNP - NC	CA18CAF08PCDU		CA30CN25PCDU	
Temperature alarm				
PNP - NO	CA18CAF08POTA		CA18CAN12POTA	
PNP - NC	CA18CAF08PCTA		CA18CAN12PCTA	
<b>Characteristics flush and non-flush mountable</b>				
Rated operating voltage	10 - 40 VDC	10 - 40 VDC	10 - 40 VDC	10 - 40 VDC
Voltage drop	≤ 2.0 VDC	≤ 2.0 VDC	≤ 2.0 VDC	≤ 2.0 VDC
Degree of protection	IP 67, IP 68, IP 69K	IP 67, IP 68, IP 69K	IP 67, IP 68, IP 69K	IP 67, IP 68, IP 69K
Protection Short-circuit (S) Reverse polarity (P) Transients (T)	SPT	SPT	SPT	SPT
Output current	< 200 mA	< 200 mA	< 200 mA	< 200 mA
Housing material	PBT	PBT	PBT	PBT
Operating temperature	-30°C to +85°C	-30°C to +85°C	-30°C to +85°C	-30°C to +85°C
LED colour	Yellow and Green	Yellow and Green	Yellow and Green	Yellow and Green
Approvals/Marks	CE - cULus - ECOLAB	CE - cULus - ECOLAB	CE - cULus - ECOLAB	CE - cULus - ECOLAB

# Capacitive proximity sensors, TRIPLESIELD™

## Types

### M30-DC TRIPLESIELD™

Connections      2 m cable      M12 connector      2 m cable      M12 connector

### Flush mountable



Dimensions (mm)	M30 x 63.6	M30 x 63.6	M30 x 63.6	M30 x 63.6
Thread (mm)	M30 x 1.5 x 50	M30 x 1.5 x 50	M30 x 1.5 x 50	M30 x 1.5 x 50
Operating frequency	50 Hz	50 Hz	50 Hz	50 Hz
Sensing distance (Sn)	2 - 16 mm (adjustable)	2 - 16 mm (adjustable)	2 - 16 mm (adjustable)	2 - 16 mm (adjustable)

### References

NPN - NO and NC	<b>EC3016NPASL</b>	<b>EC3016NPASL-1</b>	<b>EC3016NPAPL</b>	<b>EC3016NPAPL-1</b>
PNP - NO and NC	<b>EC3016PPASL</b>	<b>EC3016PPASL-1</b>	<b>EC3016PPAPL</b>	<b>EC3016PPAPL-1</b>

### Non-flush mountable



Dimensions (mm)	M30 x 75.6	M30 x 75.6	M30 x 75.6	M30 x 75.6
Thread (mm)	M30 x 1.5 x 50	M30 x 1.5 x 50	M30 x 1.5 x 50	M30 x 1.5 x 50
Operating frequency	50 Hz	50 Hz	50 Hz	50 Hz
Sensing distance (Sn)	4 - 25 mm (adjustable)	4 - 25 mm (adjustable)	4 - 25 mm (adjustable)	4 - 25 mm (adjustable)

### References





NPN - NO and NC	<b>EC3025NPASL</b>	<b>EC3025NPASL-1</b>	<b>EC3025NPAPL</b>	<b>EC3025NPAPL-1</b>
PNP - NO and NC	<b>EC3025PPASL</b>	<b>EC3025PPASL-1</b>	<b>EC3025PPAPL</b>	<b>EC3025PPAPL-1</b>

### Characteristics flush and non-flush mountable

Rated operating voltage	10 - 40 VDC	10 - 40 VDC	10 - 40 VDC	10 - 40 VDC
Voltage drop	≤ 2.5 VDC	≤ 2.5 VDC	≤ 2.5 VDC	≤ 2.5 VDC
Degree of protection	IP 67	IP 67	IP 67	IP 67
Protection Short-circuit (S) Reverse polarity (P) Transients (T)	SPT	SPT	SPT	SPT
Output current	< 200 mA	< 200 mA	< 200 mA	< 200 mA
Housing material	Stainless steel	Stainless steel	Thermoplastic polyester	Thermoplastic polyester
Operating temperature	-25°C to +80°C	-25°C to +80°C	-25°C to +80°C	-25°C to +80°C
LED colour	Yellow	Yellow	Yellow	Yellow
Approvals/Marks	CE - UL - CSA	CE - UL - CSA	CE - UL - CSA	CE - UL - CSA

# Capacitive proximity sensors, TRIPLESIELD™

## M30-DC TRIPLESIELD™

Types	Flush mountable		Non-flush mountable	
	2 m cable	M12 connector	2 m cable	M12 connector
Connections				
Dimensions (mm)	M30 x 81	M30 x 74	M30 x 81	M30 x 74
Thread (mm)	M30 x 1.5 x 59.5	M30 x 1.5 x 59.5	M30 x 1.5 x 45.5	M30 x 1.5 x 45.5
Operating frequency	50 Hz	50 Hz	50 Hz	50 Hz
Sensing distance (Sn)	2 - 20 mm (adjustable)	2 - 20 mm (adjustable)	4 - 30 mm (adjustable)	4 - 30 mm (adjustable)
<b>References</b>				
Standard				
NPN - NO and NC	CA30CAF16NA	CA30CAF16NAM1	CA30CAN25NA	CA30CAN25NAM1
PNP - NO and NC	CA30CAF16PA	CA30CAF16PAM1	CA30CAN25PA	CA30CAN25PAM1
Dust alarm				
PNP - NO	CA30CAF16PODU		CA30CAN25PODU	
PNP - NC	CA30CAF16PCDU		CA30CN25PCDU	
Temperature alarm				
PNP - NO	CA30CAF16POTA		CA30CAN25POTA	
PNP - NC	CA30CAF16PCTA		CA30CAN25PCTA	
<b>Characteristics flush and non-flush mountable</b>				
Rated operating voltage	10 - 40 VDC	10 - 40 VDC	10 - 40 VDC	10 - 40 VDC
Voltage drop	≤ 2.0 VDC	≤ 2.0 VDC	≤ 2.0 VDC	≤ 2.0 VDC
Degree of protection	IP 67, IP 68, IP 69K	IP 67, IP 68, IP 69K	IP 67, IP 68, IP 69K	IP 67, IP 68, IP 69K
Protection Short-circuit (S) Reverse polarity (P) Transients (T)	SPT	SPT	SPT	SPT
Output current	< 200 mA	< 200 mA	< 200 mA	< 200 mA
Housing material	PBT	PBT	PBT	PBT
Operating temperature	-30°C to +85°C	-30°C to +85°C	-30°C to +85°C	-30°C to +85°C
LED colour	Yellow and Green	Yellow and Green	Yellow and Green	Yellow and Green
Approvals/Marks	CE - cULus	CE - cULus	CE - cULus	CE - cULus

# Capacitive proximity sensors, TRIPLESIELD™

## Types

### M30-AC TRIPLESIELD™

**Connections**      **2 m cable**      **M12 connector**      **2 m cable**      **M12 connector**

### Flush mountable



Dimensions (mm)	M30 x 63.6	M30 x 63.6	M30 x 63.6	M30 x 63.6
Thread (mm)	M30 x 1.5 x 50	M30 x 1.5 x 50	M30 x 1.5 x 50	M30 x 1.5 x 50
Operating frequency	10 Hz	10 Hz	10 Hz	10 Hz
Sensing distance (Sn)	2 - 16 mm (adjustable)	2 - 16 mm (adjustable)	2 - 16 mm (adjustable)	2 - 16 mm (adjustable)

### References

Thyristor (SCR) NO or NC	<b>EC3016TBAPL</b>	<b>EC3016TBAPL-6</b>	<b>EC3016TBASL</b>	<b>EC3016TBASL-6</b>
--------------------------	--------------------	----------------------	--------------------	----------------------

### Non-flush mountable



Dimensions (mm)	M30 x 75.6	M30 x 75.6	M30 x 75.6	M30 x 75.6
Thread (mm)	M30 x 1.5 x 50	M30 x 1.5 x 50	M30 x 1.5 x 50	M30 x 1.5 x 50
Operating frequency	10 Hz	10 Hz	10 Hz	10 Hz
Sensing distance (Sn)	4 - 25 mm (adjustable)	4 - 25 mm (adjustable)	4 - 25 mm (adjustable)	4 - 25 mm (adjustable)

### References

Thyristor (SCR) NO or NC	<b>EC3025TBAPL</b>	<b>EC3025TBAPL-6</b>	<b>EC3025TBASL</b>	<b>EC3025TBASL-6</b>
--------------------------	--------------------	----------------------	--------------------	----------------------



### Characteristics flush and non-flush mountable

Rated operating voltage	20 - 250 VAC	20 - 250 VAC	20 - 250 VAC	20 - 250 VAC
Voltage drop	< 10 VAC	< 10 VAC	< 10 VAC	< 10 VAC
Degree of protection	IP 67	IP 67	IP 67	IP 67
Protection Short-circuit (S) Reverse polarity (P) Transients (T)	T	T	T	T
Output current	< 500 mA	< 500 mA	< 500 mA	< 500 mA
Housing material	Thermoplastic polyester	Thermoplastic polyester	Stainless steel	Stainless steel
Operating temperature	-25°C to +80°C	-25°C to +80°C	-25°C to +80°C	-25°C to +80°C
LED colour	Yellow	Yellow	Yellow	Yellow
Approvals/Marks	CE - UL - CSA	CE - UL - CSA	CE - UL - CSA	CE - UL - CSA

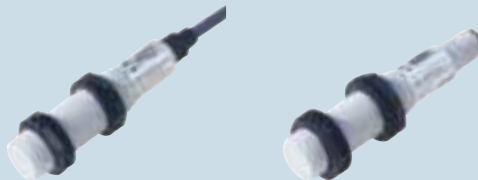

## Capacitive proximity sensors, TRIPLESIELD™

Types	M12 teach-in TRIPLESIELD™		M18 teach-in TRIPLESIELD™	
Connections	2 m cable	M12 connector	2 m cable	M12 connector
<b>Flush mountable</b>				
Dimensions (mm)	M12 x 82.4	M12 x 84.7	M18 x 89.55	M18 x 89.2
Thread (mm)	M12 x 1 x 50	M12 x 1 x 50	M18 x 1 x 50	M18 x 1 x 50
Operating frequency	15 Hz	15 Hz	15 Hz	15 Hz
Sensing distance (Sn)	0.5 - 8 mm (Teach-in)	0.5 - 8 mm (Teach-in)	0.2 - 12 mm (Teach-in)	0.2 - 12 mm (Teach-in)
<b>References</b>				
NPN/PNP, NO/NC	CA12CLC08BP	CA12CLC08BPM1	CA18CLC12BP	CA18CLC12BPM1
<b>Characteristics flush and non-flush mountable</b>				
Rated operating voltage	10 - 40 VDC	10 - 40 VDC	10 - 40 VDC	10 - 40 VDC
Voltage drop	< 2.5 VDC	< 2.5 VDC	< 2.5 VDC	< 2.5 VDC
Degree of protection	IP 68	IP 68	IP 68	IP 68
Protection Short-circuit (S) Reverse polarity (P) Transients (T)	SPT	SPT	SPT	SPT
Output current	< 250 mA	< 250 mA	< 250 mA	< 250 mA
Housing material	Thermoplastic polyester	Thermoplastic polyester	Thermoplastic polyester	Thermoplastic polyester
Operating temperature	-25°C to +85°C	-25°C to +85°C	-25°C to +85°C	-25°C to +85°C
Special features	Teach-in, humidity compensation NPN/PNP auto detection, remote setup, alarm output. On request: dirt and moisture compensation	Teach-in, humidity compensation NPN/PNP auto detection, remote setup, alarm output. On request: dirt and moisture compensation	Teach-in, humidity compensation NPN/PNP auto detection, remote setup, alarm output. On request: dirt and moisture compensation	Teach-in, humidity compensation NPN/PNP auto detection, remote setup, alarm output. On request: dirt and moisture compensation
Approvals/Marks	CE - UL - CSA	CE - UL - CSA	CE - UL - CSA	CE - UL - CSA

## Capacitive proximity sensors, TRIPLESIELD™

Types	M30 teach in TRIPLESIELD™		M30 AC/DC TRIPLESIELD™	
Connections	2 m cable	M12 connector	2 m cable	M12 connector
<b>Flush mountable</b>				
Dimensions (mm)	M30 x 99.2	M30 x 90.45	M30 x 63.6	M30 x 75.6
Thread (mm)	M30 x 1.5 x 50	M30 x 1.5 x 50	M30 x 1.5 x 50	M30 x 1.5 x 50
Operating frequency	15 Hz	15 Hz	10 Hz	10 Hz
Sensing distance (Sn)	0.5 - 30 mm (adjustable)	0.5 - 30 mm (adjustable)	2 - 16 mm (adjustable)	2 - 16 mm (adjustable)
<b>References</b>				
NPN/PNP, NO/NC	<b>CA30CLC30BP</b>	<b>CA30CLC30BPM1</b>		
Power MOFSET			<b>CA30CLF16CP</b>	<b>CA30CLF16CPM6</b>
<b>Non-flush mountable</b>				
Dimensions (mm)			M30 x 71.6	M30 x 83.6
Thread (mm)			M30 x 1.5 x 50	M30 x 1.5 x 50
Operating frequency			10 Hz	10 Hz
Sensing distance (Sn)			2 - 25 mm (adjustable)	2 - 25 mm (adjustable)
<b>References</b>				
Power MOFSET			<b>CA30CLN25CP</b>	<b>CA30CLN25CPM6</b>
<b>Characteristics flush and non-flush mountable</b>				
Rated operating voltage	10 - 40 VDC	10 - 40 VDC	20 - 250 VAC/DC	20 - 250 VAC/DC
Voltage drop	< 2.5 VDC	< 2.5 VDC	< 5.5 VAC/DC	< 5.5 VAC/DC
Degree of protection	IP 68	IP 68	IP 67	IP 67
Protection Short-circuit (S)				
Reverse polarity (P)	SPT	SPT	PT	PT
Transients (T)				
Output current	< 250 mA	< 250 mA	< 250 mA DC < 350 mA AC	< 250 mA DC < 350 mA AC
Housing material	Thermoplastic polyester	Thermoplastic polyester	Thermoplastic polyester	Thermoplastic polyester
Operating temperature	-20°C to +85°C	-20°C to +85°C	-25°C to +80°C	-25°C to +80°C
LED colour	Yellow	Yellow	Yellow	Yellow
Special features	Teach-in, humidity compensation NPN/PNP auto detection, remote setup, alarm output. On request: dirt and moisture compensation	Teach-in, humidity compensation NPN/PNP auto detection, remote setup, alarm output. On request: dirt and moisture compensation		
Approvals/Marks	CE - UL - CSA	CE - UL - CSA	CE - UL - CSA	CE - UL - CSA





## Capacitive proximity sensors, TRIPLESIELD™

Types	M18 TRIPLESIELD™, chemical resistant		
Connections	2 m cable	2 m cable	2 m cable
<b>Flush mountable</b>			
Dimensions (mm)	M18 x 71.5	M18 x 71.5	M18 x 71.5
Thread (mm)	M18 x 1 x 46.5	M18 x 1 x 46.5	M18 x 1 x 46.5
Operating frequency	30 Hz	30 Hz	30 Hz
Sensing distance (Sn)	3 - 8 mm (adjustable)	3 - 8 mm (adjustable)	3 - 8 mm (adjustable)
<b>References</b>			
NPN-NO/NC	CA18HLF08NA	CA18GLF08NA	CA18FLF08NA
PNP-NO/NC	CA18HLF08PA	CA18GLF08PA	CA18FLF08PA

<b>Non-flush mountable</b>	
Dimensions (mm)	M18 x 71.5
Thread (mm)	M18 x 1 x 46.5
Operating frequency	30 Hz
Sensing distance (Sn)	3 - 12 mm (adjustable)
<b>References</b>	
NPN-NO/NC	CA18HLN12NA
PNP-NO/NC	CA18HLN12PA



Characteristics flush and non-flush mountable			
Rated operating voltage	10 - 40 VDC	10 - 40 VDC	10 - 40 VDC
Voltage drop	≤ 2.5 VDC	≤ 2.5 VDC	≤ 2.5 VDC
Degree of protection	IP 67	IP 67	IP 67
Protection Short-circuit (S) Reverse polarity (P) Transients (T)	SPT	SPT	SPT
Output current	< 200 mA	< 200 mA	< 200 mA
Housing material	Polypropylene	PVC	Teflon
Operating temperature	-25°C to +80°C	-25°C to +80°C	-25°C to +80°C
LED colour	Yellow	Yellow	Yellow
Approvals/Marks	CE	CE	CE

## Capacitive proximity sensors, TRIPLESIELD™



Types	VC5510	VC5510 Time delay	CD50	
Connections	1.5 m cable	1.5 m cable	2 m cable	2 m cable
Flush mountable				
Dimensions (mm)	55 x 35 x 15	55 x 35 x 15	50 x 30 x 7	50 x 30 x 7
Operating frequency	> 15 Hz	> 0.1 Hz	10 Hz	10 Hz
Sensing distance (Sn)	10 mm	10 mm	6 mm	5 mm
<b>References</b>				
NPN - NO	VC5510NNOP	VC5510NNOPT	CD50CNF06NO	CD50CNF05NO
NPN - NC	VC5510NNCP	VC5510NNCPT		
PNP - NO	VC5510PNOP	VC5510PNOPT		
PNP - NC	VC5510PNCP	VC5510PNCPT		
Sensing distance (Sn)			7 mm	
PNP - NO			CD50CNF07PO	
NPN - NC			CD50CNF07NC	
Sensing distance (Sn)			10 mm	
PNP - NO			CD50CNF10PO	
NPN - NC			CD50CNF10NC	
<b>Characteristics flush and non-flush mountable</b>				
Rated operating voltage	5 - 30 VDC	5 - 30 VDC	10 - 30 VDC	5 VDC
Voltage drop	≤ 1.5 VDC	≤ 1.5 VDC	≤ 1.5 V	≤ 1.5 V
Degree of protection	IP65	IP 65	IP 67	IP 67
Output current	≤ 100 mA	≤ 100 mA	≤ 50 mA	≤ 50 mA
Housing material	PC/ABS	PC/ABS	Noryl, grey	Noryl, grey
Operating temperature	0°C to +50°C	0°C to +50°C	0°C to +60°C	0°C to +60°C
LED colour	Red	Red		
Approvals/Marks	CE - UL	CE - UL	CE	CE



## Capacitive proximity sensors, TRIPLESIELD™

Types	CD46 teach-in TRIPLESIELD™	EC 5525 TRIPLESIELD™	
Connections	2 m cable	2 m cable	M12 connector
Flush or non-Flush mountable			
Dimensions short body (mm)	46 x 28 x 5.5	55 x 35 x 15	55 x 35 x 15
Operating frequency	10 Hz	50 Hz	50 Hz
Sensing distance (Sn)	1.0 - 10 mm (Teach-in)	4 - 25 mm	4 - 25 mm
<b>References</b>			
NPN-NO/NC	CD46CNC10NP	EC5525NPAP	EC5525NPAP-1
PNP-NO/NC	CD46CNC10PP	EC5525PPAP	EC5525PPAP-1
<b>Characteristics flush and non-flush mountable</b>			
Rated operating voltage	10 - 30 VDC	10 - 40 VDC	10 - 40 VDC
Voltage drop	≤ 2.5 VDC	≤ 2.5 VDC	≤ 2.5 VDC
Degree of protection	IP 68	IP 67	IP 67
Protection Short-circuit (S) Reverse polarity (P) Transients (T)	SPT	SPT	SPT
Output current	≤ 200 mA	≤ 200 mA	≤ 200 mA
Housing material	PBT	Polycarbonate	Polycarbonate
Operating temperature	-25°C to +80°C	-25°C to +80°C	-25°C to +80°C
LED colour	Yellow, Green	Yellow	Yellow
Special features	Teach-in, remote setup, alarm output		
Approvals/Marks	CE - UL - CSA	CE - UL - CSA	CE - UL - CSA

## Capacitive proximity sensors, TRIPLESIELD™

Types	M18 teach-in TRIPLESIELD™		M30 teach-in TRIPLESIELD™	
Connections	2 m cable	M12 connector	2 m cable	M12 connector
<b>Flush or non-flush mountable</b>				
Dimensions (mm)	M18 x 89.55	M18 x 89.2	M30 x 99.2	M30 x 99.45
Thread (mm)	M18 x 1 x 50	M18 x 1 x 50	M30 x 1.5 x 50	M30 x 1.5 x 50
Operating frequency	5 Hz	5 Hz	5 Hz	5 Hz
Sensing distance (Sn)	0.5 - 12 mm (Teach-in)	0.5 - 12 mm (Teach-in)	0.5 - 30 mm (Teach-in)	0.5 - 30 mm (Teach-in)
<b>References</b>				
NPN/PNP, NO/NC	<b>CA18CLL12BP</b>	<b>CA18CLL12BPM1</b>	<b>CA30CLL30BP</b>	<b>CA30CLL30BPM1</b>
<b>Characteristics flush and non-flush mountable</b>				
Rated operating voltage	10 - 40 VDC	10 - 40 VDC	10 - 40 VDC	10 - 40 VDC
Voltage drop	≤ 2.5 VDC	≤ 2.5 VDC	≤ 2.5 VDC	≤ 2.5 VDC
Degree of protection	IP 68	IP 68	IP 68	IP 68
Output current	≤ 250 mA	≤ 250 mA	≤ 250 mA	≤ 250 mA
Housing material	Thermoplastic polyester	Thermoplastic polyester	Thermoplastic polyester	Thermoplastic polyester
Operating temperature	-20°C to +85°C	-20°C to +85°C	-20°C to +85°C	-20°C to +85°C
Max. temperature on sensing face	120°C (248°F)	120°C (248°F)	120°C (248°F)	120°C (248°F)
LED colour	Yellow	Yellow	Yellow	Yellow
Special features	Single-step Teach-in, humidity compensation NPN/ PNP auto detection, remote setup, alarm output. On request: dirt and moisture compensation	Single-step Teach-in, humidity compensation NPN/ PNP auto detection, remote setup, alarm output. On request: dirt and moisture compensation	Single-step Teach-in, humidity compensation NPN/ PNP auto detection, remote setup, alarm output. On request: dirt and moisture compensation	Single-step Teach-in, humidity compensation NPN/ PNP auto detection, remote setup, alarm output. On request: dirt and moisture compensation
Approvals/Marks	CE - UL - CSA	CE - UL - CSA	CE - UL - CSA	CE - UL - CSA

# Capacitive level sensors

**Types** Capacitive level sensors for solid, fluid and granulated substances

**Connections** 2 m cable 2 m cable 2 m cable 2 m cable

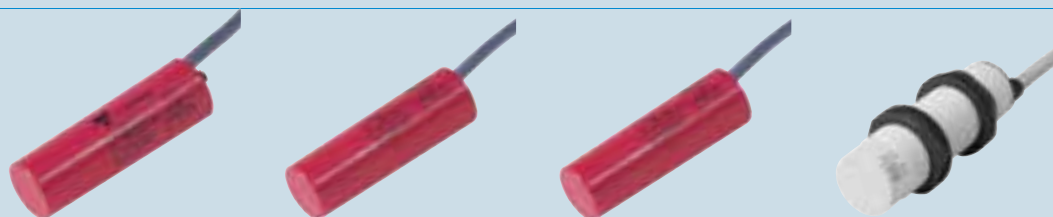

Dimensions (mm)	Ø32 x 101	Ø32 x 101	Ø32 x 101	M30 x 101
Thread	Smooth	Smooth	Smooth	M30 (with 2 nuts)
Operating frequency	1 Hz	1 Hz	1 Hz	1 Hz
Sensing distance (Sn)	4 - 12 mm (adjustable)	4 - 12 mm (adjustable)	4 - 12 mm (adjustable)	4 - 12 mm (adjustable)

## References with ON delay

Time delay	1 s - 10 m			1 s - 10 m
120 VAC	<b>VC11RT12010M</b>			
230 VAC	<b>VC11RT23010M</b>			
24 VAC/DC	<b>VC11RT92410M</b>			
24-230 VAC/DC	<b>VC11RTM2410M</b>			<b>CA30CLN12MU10M</b>

## References with OFF delay

Time delay		1 s - 10 m		1 s - 10 m
120 VAC		<b>VC12RT12010M</b>		
230 VAC		<b>VC12RT23010M</b>		
24 VAC/DC		<b>VC12RT92410M</b>		
24-230 VAC/DC		<b>VC12RTM2410M</b>		<b>CA30CLN12MV10M</b>

## References without delay

120 VAC			<b>VC12RN120</b>	
230 VAC			<b>VC12RN230</b>	
24 VAC/DC			<b>VC12RN924</b>	
24-230 VAC/DC			<b>VC12RNM24</b>	<b>CA30CLN12MT</b>

## Specifications

Consumption	≤ 1.5 W	≤ 1.5 W	≤ 1.5 W	≤ 2.5 W
Consumption M24 versions	≤ 2.5 W	≤ 2.5 W	≤ 2.5 W	
Hysteresis	1.5 mm at 7 mm sensing distance	1.5 mm at 7 mm sensing distance	1.5 mm at 7 mm sensing distance	3 - 20%
Output	Relay SPDT 2 A / 240 VAC	Relay SPDT 2 A / 240 VAC	Relay SPDT 2 A / 240 VAC	Relay SPDT 2 A / 240 VAC
Degree of protection	IP 67	IP 67	IP 67	IP 67
Housing material	Thermoplastic polyester	Thermoplastic polyester	Thermoplastic polyester	PBT, grey
Operating temperature	-20°C to +70°C	-20°C to +70°C	-20°C to +70°C	-20°C to +70°C
LED colour	Red	Red	Red	Yellow
Approvals/Marks	CE	CE - CSA	CE	CE, CSA
UL508	cULus (M24 versions)	cULus (M24 versions)	cULus (M24 versions)	cULus
NEMA				1, 2, 4, 4X, 5, 6, 6P, 12

## Capacitive level sensors

	Ø18 sensors for solid, fluid and granulated substances		Ø32 sensors
Types	2-wire, AC	3-wire, DC	2-wire, AC
Connections	2 m cable	2 m cable	2 m cable
			
Dimensions (mm)	Ø18 x 86	Ø18 x 86	Ø32 x 101
Thread	Smooth	Smooth	Smooth
Operating frequency	10 Hz	30 Hz	10 Hz
Sensing distance (Sn)	3 - 12 mm (adjustable)	3 - 12 mm (adjustable)	2 - 20 mm (adjustable)
<b>References</b>			
Thyristor (SCR) NO	<b>CB18CLN12TOFT</b>		
Thyristor (SCR) NO ATEX	<b>CB18CLN12TOFTAX</b>		
Thyristor (SCR) NC	<b>CB18CLN12TCFT</b>		
Thyristor (SCR) NC ATEX	<b>CB18CLN12TCFTAX</b>		
NPN - NO/NC		<b>CB18CLN12NA</b>	
NPN - NO/NC ATEX		<b>CB18CLN12NAAX</b>	
PNP - NO/NC		<b>CB18CLN12PA</b>	
PNP - NO/NC ATEX		<b>CB18CLN12PAAX</b>	
ON-delay			No
Thyristor (SCR) NO			<b>CB32CLN20TO</b>
Thyristor (SCR) NO ATEX			<b>CB32CLN20TOAX</b>
Thyristor (SCR) NC			<b>CB32CLN20TC</b>
Thyristor (SCR) NC ATEX			<b>CB32CLN20TCAX</b>
ON-delay			Yes
Thyristor (SCR) NO			<b>CB32CLN20TOFT</b>
Thyristor (SCR) NO ATEX			<b>CB32CLN20TOFTAX</b>
Thyristor (SCR) NC			<b>CB32CLN20TCFT</b>
Thyristor (SCR) NC ATEX			<b>CB32CLN20TCFTAX</b>
<b>Specifications</b>			
Rated operating voltage	20 - 250 VAC	10 - 40 VDC	20 - 250 VAC
Voltage drop	≤ 10 VAC	≤ 10 VAC	≤ 10 VAC
Time delay	30 s ON-delay		30 s ON-delay
Degree of protection	IP 67	IP 67	IP 67
Protection Short-circuit (S)			
Reverse polarity (P)	T	SPT	T
Transients (T)			
Output current	≤ 500 mA	≤ 200 mA	≤ 500 mA
Housing material	Thermoplastic polyester	Thermoplastic polyester	Thermoplastic polyester
Operating temperature	-25°C to +80°C	-25°C to +80°C	-20°C to +70°C
LED colour	Yellow	Yellow	Yellow
Approvals/Marks	CE - UL - CSA - ATEX	CE - UL - CSA - ATEX	CE - UL - CSA - ATEX

# Capacitive level sensors

## Types

Ø32 level sensors TRIPLESIELD™ - ATEX

### Connections

With ON delay

With OFF delay

Without time delay



Dimensions (mm)	Ø32 x 101	Ø32 x 101	Ø32 x 101
Thread	Smooth	Smooth	Smooth
Operating frequency	5 Hz	5 Hz	5 Hz
Sensing distance (Sn)	4 - 20 mm (adjustable)	4 - 20 mm (adjustable)	4 - 20 mm (adjustable)





### References

Cable length	2 m	2 m	2 m
120 VAC	<b>CB32CLN20SUAX</b>	<b>CB32CLN20SVAX</b>	<b>CB32CLN20STAX</b>
230 VAC	<b>CB32CLN20RUAX</b>	<b>CB32CLN20RVAX</b>	<b>CB32CLN20RTAX</b>
24 VAC/DC	<b>CB32CLN20QUAX</b>	<b>CB32CLN20QVAX</b>	<b>CB32CLN20QTAX</b>
Cable length	5 m	5 m	5 m
120 VAC	<b>CB32CLN20SUAX5M</b>	<b>CB32CLN20SVAX5M</b>	<b>CB32CLN20STAX5M</b>
230 VAC	<b>CB32CLN20RUAX5M</b>	<b>CB32CLN20RVAX5M</b>	<b>CB32CLN20RTAX5M</b>
24 VAC/DC	<b>CB32CLN20QUAX5M</b>	<b>CB32CLN20QVAX5M</b>	<b>CB32CLN20QTAX5M</b>
Cable length	10 m	10 m	10 m
120 VAC	<b>CB32CLN20SUAX10M</b>	<b>CB32CLN20SVAX10M</b>	<b>CB32CLN20STAX10M</b>
230 VAC	<b>CB32CLN20RUAX10M</b>	<b>CB32CLN20RVAX10M</b>	<b>CB32CLN20RTAX10M</b>
24 VAC/DC	<b>CB32CLN20QUAX10M</b>	<b>CB32CLN20QVAX10M</b>	<b>CB32CLN20QTAX10M</b>

### Specifications



Consumption	< 1.5 W	< 1.5 W	< 1.5 W
Hysteresis	3 to 20% of sensing distance	3 to 20% of sensing distance	3 to 20% of sensing distance
Output	Relay SPDT, 2 A / 240 VAC	Relay SPDT, 2 A / 240 VAC	Relay SPDT, 2 A / 240 VAC
Time delay	1 s - 10 m	1 s - 10 m	
Degree of protection	IP 67	IP 67	IP 67
Housing material	PBT	PBT	PBT
Operating temperature	-20°C to +70°C	-20°C to +70°C	-20°C to +70°C
LED colour	Yellow	Yellow	Yellow
Approvals/Marks	CE - ATEX	CE - ATEX	CE - ATEX

# Photoelectric sensors

	M18, DC, axial type		M18, DC, radial type	
Types	PA18CA.	PA18CA.	PA18CR.	PA18CR.
Connections	2 m cable	M12 connector	2 m cable	M12 connector
				
Dimensions (mm)	M18 x 40	M18 x 44	M18 x 50	M18 x 54
<b>Diffuse reflective</b>				
Sensing distance (Sn)	50 - 1000 mm	50 - 1000 mm	50 - 800 mm	50 - 800 mm
NPN NO+NC	PA18CAD10NASA	PA18CAD10NAM1SA	PA18CRD08NASA	PA18CRD08NAM1SA
PNP NO+NC	PA18CAD10PASA	PA18CAD10PAM1SA	PA18CRD08PASA	PA18CRD08PAM1SA
<b>Diffuse reflective WS</b>				
Sensing distance (Sn)	0 - 400 mm	0 - 400 mm		
NPN NO+NC	PA18CAD04NAWS	PA18CAD04NAM1WS		
PNP NO+NC	PA18CAD04PAWS	PA18CAD04PAM1WS		
<b>Retro reflective polariz.</b>				
Sensing distance (Sn)	5 - 500 cm	5 - 500 cm	5 - 400 cm	5 - 400 cm
NPN NO+NC	PA18CAP50NASA	PA18CAP50NAM1SA	PA18CRP40NASA	PA18CRP40NAM1SA
PNP NO+NC	PA18CAP50PASA	PA18CAP50PAM1SA	PA18CRP40PASA	PA18CRP40PAM1SA
<b>Retro reflective</b>				
Sensing distance (Sn)	5 - 650 cm	5 - 650 cm	5 - 500 cm	5 - 500 cm
NPN NO+NC	PA18CAR65NASA	PA18CAR65NAM1SA	PA18CRR50NASA	PA18CRR50NAM1SA
PNP NO+NC	PA18CAR65PASA	PA18CAR65PAM1SA	PA18CRR50PASA	PA18CRR50PAM1SA
<b>Through-beam emitter (E)</b>				
Sensing distance (Sn)	1 - 20 m	1 - 20 m	1 - 16 m	1 - 16 m
	PA18CAT20	PA18CAT20M1	PA18CRT16	PA18CRT16M1
<b>Through-beam receiver (R)</b>				
Sensing distance (Sn)	1 - 20 m	1 - 20 m	1 - 16 m	1 - 16 m
NPN NO+NC	PA18CAT20NASA	PA18CAT20NAM1SA	PA18CRT16NASA	PA18CRT16NAM1SA
PNP NO+NC	PA18CAT20PASA	PA18CAT20PAM1SA	PA18CRT16PASA	PA18CRT16PAM1SA
<b>Background suppression (BGS)</b>				
Sensing distance (Sn)	10 - 200 mm	10 - 200 mm		
NPN NO+NC	PA18CAB20NASA	PA18CAB20NAM1SA		
PNP NO+NC	PA18CAB20PASA	PA18CAB20PAM1SA		
<b>Specifications</b>				
Operating frequency	500 Hz	500 Hz	500 Hz	500 Hz
Rated operating voltage	10 - 30 VDC	10 - 30 VDC	10 - 30 VDC	10 - 30 VDC
Voltage drop	≤ 2.0 VDC @ 100 mA	≤ 2.0 VDC @ 100 mA	≤ 2.0 VDC @ 100 mA	≤ 2.0 VDC @ 100 mA
Degree of protection	IP 67 + IP 69K	IP 67 + IP 69K	IP 67 + IP 69K	IP 67 + IP 69K
Protection Short-circuit(S) Rev. polarity(P), Transients(T)	SPT	SPT	SPT	SPT
Supply current	≤ 25 mA @ 24 VDC	≤ 25 mA @ 24 VDC	≤ 25 mA @ 24 VDC	≤ 25 mA @ 24 VDC
BGS, E + R	≤ 40 mA @ 24 VDC	≤ 40 mA @ 24 VDC	≤ 40 mA @ 24 VDC	≤ 40 mA @ 24 VDC
Housing material	ABS, PMMA, PBTB	ABS, PMMA, PBTB	ABS, PMMA, PBTB	ABS, PMMA, PBTB
Operating temperature	-25°C to +60°C	-25°C to +60°C	-25°C to +60°C	-25°C to +60°C
LED colour	Yellow, Green	Yellow, Green	Yellow, Green	Yellow, Green
Approvals/Marks	CE - cULus - ECOLAB	CE - cULus - ECOLAB	CE - cULus - ECOLAB	CE - cULus - ECOLAB



# Photoelectric sensors

## M18, DC, square type

Types	PH18.	PH18.	PH18.
Connections	2 m cable	M12 connector	Pigtail M12
			
Dimensions (mm)	15 x 21 (31.5) x 35	15 x 21 (31.5) x 35	15 x 21 (31.5) x 35
<b>Diffuse reflective</b>			
Sensing distance (Sn)	50 - 1000 mm	50 - 1000 mm	50 - 1000 mm
NPN NO+NC	<b>PH18CND10NASA</b>	<b>PH18CND10NAM1SA</b>	<b>PH18CND10NAT1SA</b>
PNP NC+NC	<b>PH18CND10PASA</b>	<b>PH18CND10PAM1SA</b>	<b>PH18CND10PAT1SA</b>
<b>Retro reflective polariz.</b>			
Sensing distance (Sn)	5 - 500 cm	5 - 500 cm	5 - 500 cm
NPN NO+NC	<b>PH18CNP50NASA</b>	<b>PH18CNP50NAM1SA</b>	<b>PH18CNP50NAT1SA</b>
PNP NO+NC	<b>PH18CNP50PASA</b>	<b>PH18CNP50PAM1SA</b>	<b>PH18CNP50PAT1SA</b>
<b>Retro reflective</b>			
Sensing distance (Sn)	5 - 650 cm	5 - 650 cm	5 - 650 cm
NPN NO+NC	<b>PH18CNR65NASA</b>	<b>PH18CNR65NAM1SA</b>	<b>PH18CNR65NAT1SA</b>
PNP NO+NC	<b>PH18CNR65PASA</b>	<b>PH18CNR65PAM1SA</b>	<b>PH18CNR65PAT1SA</b>
<b>Through-beam emitter (E)</b>			
Sensing distance (Sn)	1 - 20 m	1 - 20 m	1 - 20 m
	<b>PH18CNT20</b>	<b>PH18CNT20M1</b>	<b>PH18CNT20T1</b>
<b>Through-beam receiver (R)</b>			
Sensing distance (Sn)	1 - 20 m	1 - 20 m	1 - 20 m
NPN NO+NC	<b>PH18CNT20NASA</b>	<b>PH18CNT20NAM1SA</b>	<b>PH18CNT20NAT1SA</b>
PNP NO+NC	<b>PH18CNT20PASA</b>	<b>PH18CNT20PAM1SA</b>	<b>PH18CNT20PAT1SA</b>
<b>Background suppression (BGS)</b>			
Sensing distance (Sn)	8 - 200 mm	8 - 200 mm	8 - 200 mm
NPN NO+NC	<b>PH18CNB20NASA</b>	<b>PH18CNB20NAM1SA</b>	<b>PH18CNB20NAT1SA</b>
PNP NO+NC	<b>PH18CNB20PASA</b>	<b>PH18CNB20PAM1SA</b>	<b>PH18CNB20PAT1SA</b>
<b>Specifications</b>			
Operating frequency	500 Hz	500 Hz	500 Hz
Rated operating voltage	10 - 30 VDC	10 - 30 VDC	10 - 30 VDC
Voltage drop	≤ 2.0 VDC @ 100 mA	≤ 2.0 VDC @ 100 mA	≤ 2.0 VDC @ 100 mA
Degree of protection	IP 67 + IP 69K	IP 67 + IP 69K	IP 67 + IP 69K
Protection Short-circuit (S) Reverse polarity (P) Transients (T)	SPT	SPT	SPT
Supply current BGS, E + R	≤ 25 mA @ 24 VDC ≤ 40 mA @ 24 VDC	≤ 25 mA @ 24 VDC ≤ 40 mA @ 24 VDC	≤ 25 mA @ 24 VDC ≤ 40 mA @ 24 VDC
Housing material	ABS, PMMA	ABS, PMMA	ABS, PMMA
Operating temperature	-25°C to +60°C	-25°C to +60°C	-25°C to +60°C
LED colour	Yellow, Green	Yellow, Green	Yellow, Green
Approvals/Marks	CE - cULus - ECOLAB	CE - cULus - ECOLAB	CE - cULus - ECOLAB





# Photoelectric sensors

## M18 metal, DC, integrated amplifier





Types	E.18..	E.18..-1
Connections	2 m cable	M12 connector
		
Dimensions (mm)	M18 x 55	M18 x 67
<b>Diffuse reflective</b>		
Operating frequency	120 Hz	120 Hz
Sensing distance (Sn)	400 mm, adjustable	400 mm, adjustable
NPN NO+NC	<b>EO1804NPAS</b>	<b>EO1804NPAS-1</b>
PNP NC+NC	<b>EO1804PPAS</b>	<b>EO1804PPAS-1</b>
<b>Retro reflective polariz.</b>		
Operating frequency	100 Hz	100 Hz
Sensing distance (Sn)	2 m, adjustable	2 m, adjustable
NPN NO+NC	<b>EP1820NPAS</b>	<b>EP1820NPAS-1</b>
PNP NO+NC	<b>EP1820PPAS</b>	<b>EP1820PPAS-1</b>
<b>Retro reflective</b>		
Operating frequency	120 Hz	120 Hz
Sensing distance (Sn)	3 m, adjustable	3 m, adjustable
NPN NO+NC	<b>ER1830NPAS</b>	<b>ER1830NPAS-1</b>
PNP NO+NC	<b>ER1830PPAS</b>	<b>ER1830PPAS-1</b>
<b>Through-beam emitter</b>		
Sensing distance (Sn)	20 m	20 m
	<b>ET1820</b>	<b>ET1820-1</b>
<b>Through-beam receiver</b>		
Operating frequency	170 Hz	170 Hz
Sensing distance (Sn)	20 m, adjustable	20 m, adjustable
NPN NO+NC	<b>ET1820NPAS</b>	<b>ET1820NPAS-1</b>
PNP NO+NC	<b>ET1820PPAS</b>	<b>ET1820PPAS-1</b>
<b>Fiber optic</b>		
Operating frequency	120 Hz	120 Hz
Sensing distance (Sn)	Fibre dependent	Fibre dependent
NPN NO+NC	<b>EF1801NPAS</b>	<b>EF1801NPAS-1</b>
PNP NO+NC	<b>EF1801PPAS</b>	<b>EF1801PPAS-1</b>
<b>Specifications</b>		
Rated operating voltage	10 - 40 VDC	10 - 40 VDC
Voltage drop	≤ 2.5 VDC	≤ 2.5 VDC
Degree of protection	IP 67	IP 67
Protection Short-circuit (S) Rev. polarity (P) Transients (T)	SPT	SPT
Load current	< 200 mA	< 200 mA
Housing material	Nickel-plated brass	Nickel-plated brass
Operating temperature	-20°C to +60°C	-20°C to +60°C
LED colour	Yellow	Yellow
Approvals/Marks	CE	CE







# Photoelectric sensors

	M18 plastic, AC, integrated amplifier		M18 metal, AC, integrated amplifier	
Types	PA18CL	PA18CL.M6	PA18AL	PA18AL..M6
Connections	2 m cable	M12 connector	2 m cable	M12 connector
				
Dimensions (mm)	M18 x 71.5	M18 x 83.5	M18 x 71.5	M18 x 83.5
<b>Diffuse reflective</b>				
Operating frequency	20 Hz	20 Hz	20 Hz	20 Hz
Sensing distance (Sn)	100 mm, fixed	100 mm, fixed		
Thyristor (SCR) NC	PA18CLD01TC	PA18CLD01TCM6		
Thyristor (SCR) NO	PA18CLD01TO	PA18CLD01TOM6		
Sensing distance (Sn)	200 mm, fixed	200 mm, fixed		
Thyristor (SCR) NC	PA18CLD02TC	PA18CLD02TCM6		
Thyristor (SCR) NO	PA18CLD02TO	PA18CLD02TOM6		
Sensing distance (Sn)	400 mm, fixed	400 mm, fixed		
Thyristor (SCR) NC	PA18CLD04TC	PA18CLD04TCM6		
Thyristor (SCR) NO	PA18CLD04TO	PA18CLD04TOM6		
Sensing distance (Sn)	400 mm, adjustable	400 mm, adjustable	400 mm, adjustable	400 mm, adjustable
Thyristor (SCR) NC	PA18CLD04TCSA	PA18CLD04TCM6SA	PA18ALD04TCSA	PA18ALD04TCM6SA
Thyristor (SCR) NO	PA18CLD04TOSA	PA18CLD04TOM6SA	PA18ALD04TOSA	PA18ALD04TOM6SA
<b>Retro reflective polariz.</b>				
Operating frequency	25 Hz	25 Hz	25 Hz	25 Hz
Sensing distance (Sn)	2 m, fixed	2 m, fixed	2 m, adjustable	2 m, adjustable
Thyristor (SCR) NC	PA18CLP20TC	PA18CLP20TCM6	PA18ALP20TCSA	PA18ALP20TCM6SA
Thyristor (SCR) NO	PA18CLP20TO	PA18CLP20TOM6	PA18ALP20TOSA	PA18ALP20TOM6SA
<b>Retro reflective</b>				
Operating frequency	20 Hz	20 Hz	20 Hz	20 Hz
Sensing distance (Sn)	3 m, fixed	3 m, fixed	3 m, adjustable	3 m, adjustable
Thyristor (SCR) NC	PA18CLR30TC	PA18CLR30TCM6	PA18ALR30TCSA	PA18ALR30TCM6SA
Thyristor (SCR) NO	PA18CLR30TO	PA18CLR30TOM6	PA18ALR30TOSA	PA18ALR30TOM6SA
<b>Specifications</b>				
Rated operating voltage	20 - 250 VAC	20 - 250 VAC	20 - 250 VAC	20 - 250 VAC
Voltage drop	≤ 10 VAC	≤ 10 VAC	≤ 10 VAC	≤ 10 VAC
Off state current	≤ 5 mA AC	≤ 5 mA AC	≤ 5 mA AC	≤ 5 mA AC
Degree of protection	IP 67	IP 67	IP 67	IP 67
Protection Short-circuit (S)				
Reverse polarity (P)	PT	PT	PT	PT
Transients (T)				
Load current	< 500 mA	< 500 mA	< 500 mA	< 500 mA
Housing material	Polyester (PBTP)	Polyester (PBTP)	Nickel-plated brass	Nickel-plated brass
Operating temperature	-20°C to +60°C	-20°C to +60°C	-20°C to +60°C	-20°C to +60°C
LED colour	Yellow	Yellow	Yellow	Yellow
Approvals/Marks	CE - UL - CSA	CE - UL - CSA	CE - UL - CSA	CE - UL - CSA

# Photoelectric sensors

	Integrated amplifier		Integrated amplifier, transparent	
Types	PD30 - Advanced with teach-in			
Connections	2 m cable	M8 connector	2 m cable	M8 connector
				
Dimensions (mm)	10 x 30 x 20	10 x 30 x 20	10 x 30 x 20	10 x 30 x 20
<b>Retro reflective</b>				
Operating frequency	1000 Hz	1000 Hz	1000 Hz	1000 Hz
Sensing distance (Sn)	6 m, Teach-in	6 m, Teach-in	2 m, Teach-in	2 m, Teach-in
Mute NPN NO/NC	PD30CNR06NPMU	PD30CNR06NPM5MU	PD30CNG02NPMU	PD30CNG02NPM5MU
Mute PNP NO/NC	PD30CNR06PPMU	PD30CNR06PPM5MU	PD30CNG02PPMU	PD30CNG02PPM5MU
Dust NPN NO/NC	PD30CNR06NPDU	PD30CNR06NPM5DU		
Dust PNP NO/NC	PD30CNR06PPDU	PD30CNR06PPM5DU		
Remote NPN NO/NC	PD30CNR06NPRT	PD30CNR06NPM5RT	PD30CNG02NPRT	PD30CNG02NPM5RT
Remote PNP NO/NC	PD30CNR06PPRT	PD30CNR06PPM5RT	PD30CNG02PPRT	PD30CNG02PPM5RT
<b>Retro reflective polarized</b>				
Operating frequency	1000 Hz	1000 Hz		
Sensing distance (Sn)	6 m, Teach-in	6 m, Teach-in		
Mute NPN NO/NC	PD30CNP06NPMU	PD30CNP06NPM5MU		
Mute PNP NO/NC	PD30CNP06PPMU	PD30CNP06PPM5MU		
Dust NPN NO/NC	PD30CNP06NPDU	PD30CNP06NPM5DU		
Dust PNP NO/NC	PD30CNP06PPDU	PD30CNP06PPM5DU		
Remote NPN NO/NC	PD30CNP06NPRT	PD30CNP06NPM5RT		
Remote PNP NO/NC	PD30CNP06PPRT	PD30CNP06PPM5RT		
<b>Through-beam emitter</b>				
Sensing distance (Sn)	15 m, Teach-in	15 m, Teach-in		
NPN	PD30CNT15NMU	PD30CNT15NM5MU		
PNP	PD30CNT15PMU	PD30CNT15PM5MU		
<b>Through-beam receiver mute function</b>				
Operating frequency	1000 Hz	1000 Hz		
Sensing distance (Sn)	15 m, Teach-in	15 m, Teach-in		
Remote NPN NO/NC	PD30CNT15NPRT	PD30CNT15NPM5RT		
Remote PNP NO/NC	PD30CNT15PPRT	PD30CNT15PPM5RT		
Dust NPN NO/NC	PD30CNT15NPDU	PD30CNT15NPM5DU		
Dust PNP NO/NC	PD30CNT15PPDU	PD30CNT15PPM5DU		
<b>Specifications</b>				
Rated operating voltage	10 - 30 VDC	10 - 30 VDC	10 - 30 VDC	10 - 30 VDC
Voltage drop	≤ 2.4 VDC@100 mA	≤ 2.4 VDC@100 mA	≤ 2.4 VDC@100 mA	≤ 2.4 VDC@100 mA
Degree of protection	IP 67	IP 67	IP 67	IP 67
Protection Short-circuit (S)				
Reverse polarity (P)	SPT	SPT	SPT	SPT
Transients (T)				
Load current	≤ 100 mA	≤ 100 mA	≤ 100 mA	≤ 100 mA
Housing material	ABS	ABS	ABS	ABS
Operating temperature	-25°C to +55°C	-25°C to +55°C	-25°C to +55°C	-25°C to +55°C
LED colour	Yellow + Green	Yellow + Green	Yellow + Green	Yellow + Green
Approvals/Marks	CE	CE	CE	CE
UL508	cULus	cULus	cULus	cULus

# Photoelectric sensors

	Integrated amplifier, diffuse reflective		Laser miniature, DC, integrated amplifier	
Types	PD30 - Advanced with teach-in		LD32	LD32
Connections	2 m cable	M8 connector	2 m cable	M8 connector
				
Dimensions (mm)	10 x 30 x 20	10 x 30 x 20	12 x 20 x 32	12 x 20 x 32
<b>Diffuse reflective</b>				
Operating frequency	1000 Hz	1000 Hz	4000 Hz	4000 Hz
Sensing distance (Sn)	1 m, Teach-in	1 m, Teach-in	150 mm, Teach-in	150 mm, Teach-in
NPN NO+NC			<b>LD32CND15NPPT</b>	<b>LD32CND15NPM5T</b>
PNP NO+NC			<b>LD32CND15PPPT</b>	<b>LD32CND15PPM5T</b>
<b>Dust output</b>				
NPN NO/NC	<b>PD30CND10NPDU</b>	<b>PD30CND10NPM5DU</b>		
PNP NO/NC	<b>PD30CND10PPDU</b>	<b>PD30CND10PPM5DU</b>		
<b>Remote teach</b>				
NPN NO/NC	<b>PD30CND10NPRT</b>	<b>PD30CND10NPM5RT</b>		
PNP NO/NC	<b>PD30CND10PPRT</b>	<b>PD30CND10PPM5RT</b>		
<b>Diffuse reflective background suppress.</b>				
Operating frequency	1000 Hz	1000 Hz	4000 Hz	4000 Hz
Sensing distance (Sn)	150 mm, Teach-in	150 mm, Teach-in	60 mm, Teach-in	60 mm, Teach-in
NPN NO+NC	<b>PD30CNB15NPRT</b>	<b>PD30CNB15NPM5RT</b>	<b>LD32CNB06NPPT</b>	<b>LD32CNB06NPM5T</b>
PNP NO+NC	<b>PD30CNB15PPRT</b>	<b>PD30CNB15PPM5RT</b>	<b>LD32CNB06PPPT</b>	<b>LD32CNB06PPM5T</b>
<b>Retro reflective polarized</b>				
Operating frequency			4000 Hz	4000 Hz
Sensing distance (Sn)			1 m, Teach-in	1 m, Teach-in
NPN NO+NC			<b>LD32CNP10NPPT</b>	<b>LD32CNP10NPM5T</b>
PNP NO+NC			<b>LD32CNP10PPPT</b>	<b>LD32CNP10PPM5T</b>
<b>Specifications</b>				
Rated operating voltage	10 - 30 VDC	10 - 30 VDC	10 - 30 VDC	10 - 30 VDC
Voltage drop	≤ 2.4 VDC@100 mA	≤ 2.4 VDC@100 mA	≤ 2.4 VDC	≤ 2.4 VDC
Degree of protection	IP 67	IP 67	IP 67	IP 67
Protection Short-circuit (S)				
Reverse polarity (P)	SPT	SPT	SPT	SPT
Transients (T)				
Load current	≤ 100 mA	≤ 100 mA	≤ 100 mA	≤ 100 mA
Housing material	ABS	ABS	ABS	ABS
Operating temperature	-25°C to +55°C	-25°C to +55°C	-25°C to +60°C	-25°C to +60°C
LED colour	Yellow + Green	Yellow + Green	Yellow + Green	Yellow + Green
Approvals/Marks UL508	CE cULus	CE cULus	CE	CE
Light Source			Laser Class 2	Laser Class 2

# Photoelectric sensors

## Integrated amplifier

### Types

PD30 - Potentiometer

### Connections

2 m cable

M8 connector



Dimensions (mm)

10 x 30 x 20

10 x 30 x 20

### Retro reflective

Operating frequency

1000 Hz

1000 Hz

Sensing distance (Sn)

6 m

6 m

NPN NO/NC

PD30CNR60NASA

PD30CNR60NAM5SA

PNP NO/NC

PD30CNR60PASA

PD30CNR60PAM5SA

### Retro reflective polarized

Operating frequency

1000 Hz

1000 Hz

Sensing distance (Sn)

6 m

6 m

NPN NO/NC

PD30CNP60NASA

PD30CNP60NAM5SA

PNP NO/NC

PD30CNP60PASA

PD30CNP60PAM5SA

### Through-beam emitter

Sensing distance (Sn)

15 m

15 m

PD30CNT15

PD30CNT15M5

### Through-beam receiver

Operating frequency

500 Hz

500 Hz

Sensing distance (Sn)

15 m

15 m

NPN NO/NC

PD30CNT15NASA

PD30CNT15NAM5SA

PNP NO/NC

PD30CNT15PASA

PD30CNT15PAM5SA

### Specifications

Rated operating voltage

10 - 30 VDC

10 - 30 VDC

Voltage drop

≤ 2.0 VDC@100 mA

≤ 2.0 VDC@100 mA

Degree of protection

IP 67

IP 67

Protection Short-circuit (S)

SPT

SPT

Reverse polarity (P)

Transients (T)

Load current

≤ 100 mA

≤ 100 mA

Housing material

ABS

ABS

Operating temperature

-25°C to +60°C

-25°C to +60°C

LED colour

Yellow + Green

Yellow + Green

Approvals/Marks

CE

CE



UL508

cULus

cULus





# Photoelectric sensors

## Integrated amplifier

Types	PD30 - Potentiometer		PD30 - Potentiometer
Connections	2 m cable	M8 connector	
			
Dimensions (mm)	10 x 30 x 20	10 x 30 x 20	10 x 30 x 20
<b>Diffuse reflective</b>			
Operating frequency	1000 Hz	1000 Hz	1000 Hz
Sensing distance (Sn)	1 m	1 m	1 m
NPN NO+NC	PD30CND1ONASA	PD30CND1ONAM5SA	PD30CTD1ONASA
PNP NO+NC	PD30CND1OPASA	PD30CND1OPAM5SA	PD30CTD1OPASA
<b>Diffuse reflective, extremely wide angle, infrared light</b>			
Operating frequency			1000 Hz
Sensing distance (Sn)			1 m
NPN NO+NC			PD30CTD02NAWE
PNP NO+NC			PD30CTD02PAWE
<b>Diffuse reflective background suppression, red light</b>			
Operating frequency	500 Hz	500 Hz	500 Hz
Sensing distance (Sn)	200 mm	200 mm	200 mm
NPN NO+NC	PD30CNB2ONASA	PD30CNB2ONAM5SA	PD30CTB2ONASA
PNP NO+NC	PD30CNB2OPASA	PD30CNB2OPAM5SA	PD30CTB2OPASA
<b>Diffuse reflective background suppression, infrared light</b>			
Operating frequency	500 Hz	500 Hz	500 Hz
Sensing distance (Sn)	200 mm	200 mm	200 mm
NPN NO+NC	PD30CNB2ONAIS	PD30CNB2ONAM5IS	PD30CTB2ONAIS
PNP NO+NC	PD30CNB2OPAIS	PD30CNB2OPAM5IS	PD30CTB2OPAIS
<b>Specifications</b>			
Rated operating voltage	10 - 30 VDC	10 - 30 VDC	10 - 30 VDC
Voltage drop	≤ 2.0 VDC@100 mA	≤ 2.0 VDC@100 mA	≤ 2.0 VDC@100 mA
Degree of protection	IP 67	IP 67	IP 67
Protection Short-circuit (S) Reverse polarity (P) Transients (T)	SPT	SPT	SPT
Load current	≤ 100 mA	≤ 100 mA	≤ 100 mA
Housing material	ABS	ABS	ABS
Operating temperature	-25°C to +60°C	-25°C to +60°C	-25°C to +60°C
LED colour	Yellow + Green	Yellow + Green	Yellow + Green
Approvals/Marks UL508	CE cULus	CE cULus	CE cULus

# Photoelectric sensors

## Through-beam, transistor output

Types	PB10..	PA12	PB18..	PE12..
Connections	5 m cable	M12 connector	5 m cable	5 m cable
				
Dimensions (mm)	Ø10	M12	Ø18	Ø12
<b>Through-beam emitter</b>				
Sensing distance (Sn)	20 m	20 m	15 m	15 m
Single channel	<b>PB10CNT20</b>	<b>PA12BNT20</b>	<b>PB18CNT15</b>	<b>PE12CNT15</b>
Channel 1	<b>PB10C1T20</b>	<b>PA12B1T20</b>		<b>PE12C1T15</b>
Channel 2	<b>PB10C2T20</b>	<b>PA12B2T20</b>		<b>PE12C2T15</b>
Channel 3	<b>PB10C3T20</b>	<b>PA12B3T20</b>		<b>PE12C3T15</b>
<b>Through-beam receiver</b>				
Operating frequency	100 Hz (for 3 ch 30 Hz)	100 Hz (for 3 ch 30 Hz)	100 Hz	100 Hz
Sensing distance (Sn)	25 m	25 m	15 m	15 m
NPN NO Single channel	<b>PB10CNT20NO</b>	<b>PA12BNT20NO</b>	<b>PB18CNT15NO</b>	<b>PE12CNT15NO</b>
NPN NC Single channel	<b>PB10CNT20NC</b>	<b>PA12BNT20NC</b>	<b>PB18CNT15NC</b>	<b>PE12CNT15NC</b>
PNP NO Single channel	<b>PB10CNT20PO</b>	<b>PA12BNT20PO</b>	<b>PB18CNT15PO</b>	<b>PE12CNT15PO</b>
PNP NC Single channel	<b>PB10CNT20PC</b>	<b>PA12BNT20PC</b>	<b>PB18CNT15PC</b>	<b>PE12CNT15PC</b>
NPN NO Channel 1	<b>PB10C1T20NO</b>	<b>PA12B1T20NO</b>		<b>PE12C1T15NO</b>
NPN NC Channel 1	<b>PB10C1T20NC</b>	<b>PA12B1T20NC</b>		<b>PE12C1T15NC</b>
PNP NO Channel 1	<b>PB10C1T20PO</b>	<b>PA12B1T20PO</b>		<b>PE12C1T15PO</b>
PNP NC Channel 1	<b>PB10C1T20PC</b>	<b>PA12B1T20PC</b>		<b>PE12C1T15PC</b>
NPN NO Channel 2	<b>PB10C2T20NO</b>	<b>PA12B2T20NO</b>		<b>PE12C2T15NO</b>
NPN NC Channel 2	<b>PB10C2T20NC</b>	<b>PA12B2T20NC</b>		<b>PE12C2T15NC</b>
PNP NO Channel 2	<b>PB10C2T20PO</b>	<b>PA12B2T20PO</b>		<b>PE12C2T15PO</b>
PNP NC Channel 2	<b>PB10C2T20PC</b>	<b>PA12B2T20PC</b>		<b>PE12C2T15PC</b>
NPN NO Channel 3	<b>PB10C3T20NO</b>	<b>PA12B3T20NO</b>		<b>PE12C3T15NO</b>
NPN NC Channel 3	<b>PB10C3T20NC</b>	<b>PA12B3T20NC</b>		<b>PE12C3T15NC</b>
PNP NO Channel 3	<b>PB10C3T20PO</b>	<b>PA12B3T20PO</b>		<b>PE12C3T15PO</b>
PNP NC Channel 3	<b>PB10C3T20PC</b>	<b>PA12B3T20PC</b>		<b>PE12C3T15PC</b>
<b>Specifications</b>				
Rated operating voltage	10 - 30 VDC	10 - 30 VDC	10 - 30 VDC	10 - 30 VDC
Voltage drop	≤ 1.5 VDC	≤ 1.5 VDC	≤ 1.5 VDC	≤ 1.5 VDC
Degree of protection	IP 67	IP 67	IP 67	IP 67
Protection Short-circuit (S) Reverse polarity (P) Transients (T)	SPT	SPT	SPT	SPT
Load current	≤ 100 mA	≤ 100 mA	≤ 100 mA	≤ 100 mA
Housing material	PC	PC	PTE	PC
Operating temperature	-20°C to +50°C	-20°C to +50°C	-20°C to +50°C	-20°C to +50°C
LED colour	Green (E), Yellow (R)	Green (E), Yellow (R)		Green (E), Yellow (R)
Approvals/Marks UL 508 UL 325	CE cULus cURus	CE UL - cUL UR - cURus	CE cULus cURus	CE cULus cURus

NB! For pig-tail connector versions add C2 after the part number

# Photoelectric sensors

## DC, integrated amplifier

Types	PD70	PD112	PA.	PB.
Connections	2 m cable or connector		2 m cable or connector	
				

Dimensions (mm)	11.6 x 11.6 x 70	112 x 45 x 25	36 x 18 x 63	18 x 75 x 36
-----------------	------------------	---------------	--------------	--------------

### Diffuse reflective background suppress.

Operating frequency		Door Mode 16.7 Hz Industri mode 250 Hz	1000 Hz	1000 Hz
Sensing distance (Sn)		2.5 m, adjustable	150 mm, adjustable	150 mm, adjustable
Cable		2 m	2 m	2 m
NPN/PNP, NO+NC		-	PA15INPA/PA15IPPA	PB15INPA/PB15IPPA
NPN+PNP, NO/NC		PD112CNB25BP	-	-
Connector		M12	M12	M12
NPN/PNP, NO+NC		-	PB15INPA/PB15IPPA	PB15INPA-1/PB15IPPA-1
NPN+PNP, NO/NC		PD112CNB25BPM1		

### Retro reflective polariz.

Operating frequency			1000 Hz	1000 Hz
Sensing distance (Sn)			3 m, adjustable	3 m, adjustable
Cable			2 m	2 m
NPN/PNP, NO+NC			PA3PNPA/PA3PPPA	PB3PNPA/PB3PPPA
Connector			M12	M12
NPN/PNP, NO+NC			PB3PNPA/PB3PPPA	PB3PNPA-1/PB3PPPA-1

### Through-beam



Operating frequency	100 Hz			
Sensing distance (Sn)	12 m, adjustable			
Cable	2 m			
NPN NO (Receiver)	PD70CNT12NO			
NPN NC (Receiver)	PD70CNT12NC			
PNP NO (Receiver)	PD70CNT12PO			
PNP NC (Receiver)	PD70CNT12PC			
Mute High (Emitter)	PD70CNT12MH			
Mute Low (Emitter)	PD70CNT12ML			
Connector	M8			
NPN NO (Receiver)	PD70CNT12NOM5			
NPN NC (Receiver)	PD70CNT12NCM5			
PNP NO (Receiver)	PD70CNT12POM5			
PNP NC (Receiver)	PD70CNT12PCM5			
Mute High (Emitter)	PD70CNT12M5MH			
Mute Low (Emitter)	PD70CNT12M5ML			

### Specifications

Rated operating voltage	10 - 30 VDC	10 - 30 VDC	10 - 30 VDC	10 - 30 VDC
Voltage drop	≤ 1.8 VDC	≤ 2.5 VDC	≤ 2.5 VDC	≤ 2.5 VDC
Degree of protection	IP 67	IP 67	IP 67	IP 67
Protection Short-circuit (S)				
Reverse polarity (P)	SPT	SPT	SPT	SPT
Transients (T)				
Load current	≤ 100 mA	< 200 mA	< 200 mA	< 200 mA
Housing material	PC Black	PC Black	Aluminium	Reinforced ABS
Operating temperature	-25°C to +55°C	-25°C to +55°C	-25°C to +60°C	-25°C to +60°C
LED colour	Yellow, Receiver output Green, Emitter power ON	Yellow, Output Green, Power ON	Yellow	Yellow
Approvals/Marks	CE - cURus	CE - cULus	CE	CE

# Photoelectric sensors

## Integrated amplifier

Types	PC50	PC50..M1	PC50
Connections	2 m cable	M12 connector	2 m cable
			
Dimensions (mm)	17 x 50 x 50	17 x 50 x 50	17 x 50 x 50
<b>Diffuse reflective</b>			
Operating frequency	500 Hz	500 Hz	20 Hz
Sensing distance (Sn)	1 m, adjustable	1 m, adjustable	
NPN/PNP NO+NC	<b>PC50CND10BA</b>	<b>PC50CND10BAM1</b>	
Sensing distance (Sn)	2 m, adjustable	2 m, adjustable	
NPN/PNP NO+NC	<b>PC50CND20BA</b>	<b>PC50CND20BAM1</b>	
Sensing distance (Sn)			1 m, adjustable
Relay SPDT Multivoltage			<b>PC50CND10RP</b>
Sensing distance (Sn)			2 m, adjustable
Relay SPDT Multivoltage			<b>PC50CND20RP</b>
<b>Diffuse reflective background suppress.</b>			
Operating frequency	250 Hz	250 Hz	
Sensing distance (Sn)	500 mm, adjustable	500 mm, adjustable	
NPN/PNP NO+NC	<b>PC50CNB50BA</b>	<b>PC50CNB50BAM1</b>	
<b>Retro reflective polarized</b>			
Operating frequency	500 Hz	500 Hz	20 Hz
Sensing distance (Sn)	6 m, adjustable	6 m, adjustable	6 m, adjustable
NPN/PNP NO+NC	<b>PC50CNP06BA</b>	<b>PC50CNP06BAM1</b>	
Mute High	<b>PC50CNP06BAMH</b>	<b>PC50CNP06BAM1MH</b>	
Mute Low	<b>PC50CNP06BAML</b>	<b>PC50CNP06BAM1ML</b>	
Relay SPDT Multivoltage			<b>PC50CNP06RP</b>
<b>Retro reflective</b>			
Operating frequency	500 Hz	500 Hz	20 Hz
Sensing distance (Sn)	10 m, adjustable	10 m, adjustable	10 m, adjustable
NPN/PNP NO+NC	<b>PC50CNR10BA</b>	<b>PC50CNR10BAM1</b>	
Relay SPDT Multivoltage			<b>PC50CNP10RP</b>
<b>Through-beam emitter</b>			
Sensing distance (Sn)	20 m	20 m	20 m
	<b>PC50CNT20B</b>	<b>PC50CNT20BM1</b>	<b>PC50CNT20R</b>
<b>Through-beam receiver</b>			
Operating frequency	500 Hz	500 Hz	20 Hz
Sensing distance (Sn)	20 m, adjustable	20 m, adjustable	20 m, adjustable
NPN/PNP NO+NC	<b>PC50CNT20BA</b>	<b>PC50CNT20BAM1</b>	-
Relay SPDT Multivoltage			<b>PC50CNT20RP</b>
<b>Specifications</b>			
Rated operating voltage	10 - 30 VDC	10 - 30 VDC	12 - 240 VDC / 24 - 240 VAC
Voltage drop	≤ 2.5 VDC	≤ 2.5 VDC	Relay SPDT
Degree of protection	IP 67	IP 67	IP 67
Protection Short-circuit (S)			
Reverse polarity (P)	SPT	SPT	PT
Transients (T)			
Load current	≤ 200 mA	≤ 200 mA	≤ 3 mA
Housing material	Reinforced ABS/PC	Reinforced ABS/PC	Reinforced ABS/PC
Operating temperature	-20°C to +60°C	-20°C to +60°C	-20°C to +60°C
LED colour	Yellow + Green	Yellow + Green	Yellow + Green
Approvals/Marks	CE - UL - CSA	CE - UL - CSA	CE - UL - CSA



# Photoelectric sensors

## Integrated amplifier colour sensors

<b>Types</b>	<b>PD12CNC..BPT</b>
<b>Connections</b>	<b>M12 connector</b>



<b>Dimensions (mm)</b>	<b>61 x 26 x 115</b>
------------------------	----------------------

### Diffuse reflective

<b>Operating frequency</b>	<b>500 Hz</b>
<b>Sensing distance (Sn)</b>	<b>2 to 60 mm (fiber depend.)</b>
<b>NPN/PNP NO+PC</b>	<b>PD12CNC01BPM1T 1 Output</b>
<b>NPN/PNP NO+PC</b>	<b>PD12CNC04BPM1T 4 Output</b>





### Accessories: fibres

<b>Dist. 18 mm</b>	<b>FPDC 01 SCC 100</b>
<b>Dist. 40-60 mm</b>	<b>FPDC 02 SCC 100</b>
<b>Dist. 4-6 mm</b>	<b>FPDC 03 SCC 100</b>
<b>Dist. 2-6 mm</b>	<b>FPDC 04 SCC 100</b>
<b>Dist. 4 mm</b>	<b>FPDC 05 SCC 100</b>





### General specifications

<b>Rated operating voltage</b>	<b>24 VDC</b>
<b>Voltage drop</b>	<b>≤ 2.2 VDC</b>
<b>Degree of protection</b>	<b>IP 65</b>
<b>Protection Short-circuit (S)</b>	
<b>Reverse polarity (P)</b>	<b>SPT</b>
<b>Transients (T)</b>	
<b>Load current</b>	<b>&lt; 100 mA</b>
<b>Housing material</b>	<b>Polycarbonate</b>
<b>Operating temperature</b>	<b>0°C to +40°C</b>
<b>LED colour</b>	<b>Yellow + Green</b>
<b>Approvals/Marks</b>	<b>CE - cUL</b>

# Photoelectric sensors



	Integrated amplifier		Fork sensor	
Types	PD60..	PD60..M5	PF80..	PF74..
Connections	2 m cable	M8 connector	M8 connector	5 m cable
				
Dimensions (mm)	13 x 30 x 60	13 x 30 x 60	12 x 37.5 x 80	15 x 60 x 74
<b>Transparent detection</b>				
Operating frequency	1000 Hz	1000 Hz		
Sensing distance (Sn)	0.8 m, Teach-in	0.8 m, Teach-in		
NPN/PNP NO+NC	<b>PD60CNG08BPT</b>	<b>PD60CNG08BPM5T</b>		
Sensing distance (Sn)	1.4 m, Teach-in	1.4 m, Teach-in		
NPN/PNP NO+NC	<b>PD60CNG14BPT</b>	<b>PD60CNG14BPM5T</b>		
<b>Fibre optical sensor plastic fibres</b>				
Operating frequency	1000 Hz	1000 Hz		
Sensing distance (Sn)	200 mm	200 mm		
NPN/PNP NO+NC	<b>PD60CNX20BP</b>	<b>PD60CNX20BPM5</b>		
Sensing distance (Sn)	200 mm, Teach-in	200 mm, Teach-in		
NPN/PNP NO+NC	<b>PD60CNX20BPT</b>	<b>PD60CNX20BPM5T</b>		
<b>Fibre optical sensor glass fibres</b>				
Operating frequency	1000 Hz	1000 Hz		
Sensing distance (Sn)	200 mm	200 mm		
NPN/PNP NO+NC	<b>PD60CNV20BP</b>	<b>PD60CNV20BPM5</b>		
Sensing distance (Sn)	200 mm, Teach-in	200 mm, Teach-in		
NPN/PNP NO+NC	<b>PD60CNV20BPT</b>	<b>PD60CNV20BPM5T</b>		
<b>Contrast sensor</b>				
Operating frequency	20 kHz	20 kHz		
Sensing distance (Sn)	18 mm (fibre depend.)	18 mm (fibre depend.)		
NPN/PNP NO+NC	<b>PD60CNK18BPT</b>	<b>PD60CNK18BPM5T</b>		
<b>Fork sensor</b>				
Operating frequency			10 kHz	≤ 1100Hz
Sensing distance (Sn)			3 mm, slot width	30 mm, slot width
NPN/PNP NO+NC			<b>PF80FNT03BPM5T</b>	
PNP N.O., NPN N.C.				<b>PF74CNT30BC</b>
PNP N.C., NPN N.O.				<b>PF74CNT30BO</b>
<b>General specifications</b>				
Rated operating voltage	10 - 30 VDC	10 - 30 VDC	10 - 30 VDC	19.2 - 28.8 VDC
Voltage drop	≤ 2.0 VDC	≤ 2.0 VDC	≤ 2.0 VDC @ 100 mA ≤ 1.0 VDC @ 10 mA	≤ 1.5 VDC @ 100 mA
Degree of protection	IP 65 (IP 67 CNG type)	IP 65 (IP 67 CNG type)	IP 65	IP 65
Protection Short-circuit (S)				
Reverse polarity (P)	SPT	SPT	ST	SPT
Transients (T)				
Load current	≤ 100 mA	≤ 100 mA	≤ 40 mA	≤ 30 mA
Housing material	PC	PC	Aluminium, black	PC, black
Operating temperature	0°C to +60°C	0°C to +60°C	-20°C to +60°C	-25°C to +60°C
LED colour	Red	Red	Yellow + Red	Yellow + Green
Approvals/Marks	CE - UL - cUL	CE - UL - cUL	CE	CE

# Photoelectric sensors

	Integrated amplifier relay output			Through-beam relay output
Types	PM..	PM..	PD86	PD98
Connections	Terminals single relay	Terminal block mute input	Terminal block mute input	Terminal block mute input
				
Dimensions (mm)	25 x 65 x 81	25 x 65 x 81	86 x 44 x 39	98 x 56 x 37
<b>Diffuse reflective</b>				
Oper. freq. / Sens. dist. (Sn)	20 Hz			
Sensing distance (Sn)	0.8 m, adjustable			
Relay SPDT Multivoltage	<b>PMD8RG / RGT</b> <b>PMD8RI / RIT</b>			
<b>Retro reflective polariz.</b>				
Oper. freq. / Sens. dist. (Sn)	20 Hz / 12 m, fixed	20 Hz / 12 m, fixed	20 Hz / 12 m, fixed	
Relay SPDT Multivoltage	<b>PMP12RG / PMP12RI</b>		<b>PD86CNP12QPMU</b>	
Relay SPST (PC)	<b>PMP12RGM / PMP12RIM</b>		<b>PD86HNP12QPMU-01C</b>	
Relay SPST (ZAMAK)				
<b>Retro reflective</b>				
Oper. freq. / Sens. dist. (Sn)	20 Hz / 10 m, fixed			
Relay SPDT Multivoltage	<b>PMR10RG / RGT</b>			
Relay SPST	<b>PMR10RI / RIT</b>			
<b>Through-beam emitter</b>				
Sensing distance (Sn)	20 m	20 m	30 m (15 m default)	
	<b>PMT20G / PMT20I</b>	<b>PMT20GM / PMT20IM</b>	<b>PD98CNT30QMU*</b>	
<b>Through-beam receiver</b>				
Oper. freq. / Sens. dist. (Sn)	20 Hz / 20 m, fixed	20 Hz / 20 m, fixed	25 Hz / 30 m (15 m default)	
Relay SPDT Multivoltage	<b>PMT20RG / RGT</b> <b>PMT20RI / RIT</b>			
Relay SPST				
<b>General specifications</b>				
Rated operating voltage	12 - 240 VDC / 24 - 240 VAC	24 VAC/DC ±20%	24 VAC/DC ±20%	12 V to 24 VAC/DC
Voltage drop	Relay SPDT	Relay SPST	Relay SPST	Relay DPDT
Degree of protection	IP 67	IP 67	IP 66	IP 54
Protection Short-circuit (S)				
Reverse polarity (P)	PT	PT	PT	PT
Transients (T)				
Load current	≤ 3 A	≤ 3 A	1 A (AC), 0.5 A (DC)	1 A (AC), 0.5 A (DC)
Housing material	PC/ABS	PC/ABS	PD86C.. : PC + PMMA PD86H.. : ZAMAK + PMMA	PC/ABS
Operating temperature	-25°C to +55°C	-25°C to +55°C	-25°C to +60°C	-25°C to +60°C
LED colour	Yellow	Yellow	Yellow + Green	Yellow (receiver)
Approvals/Marks	CE - UL - CSA	CE - UL325 - UL508	CE - UL325 - UL508	CE - UL325
Remarks	G = PG 13.5 Outlet I = ½" NPT Outlet T = Timer	G = PG 13.5 Outlet I = ½" NPT Outlet Mute input	Mute input	Mute input

\* Item number set, emitter + receiver.

## Photoelectric sensors

	Edge infrared photoelectric safety switch	Heavy duty infrared barrier	Through-beam relay output
<b>Types</b>	<b>IREPSS1</b>	<b>IRPHS20 / IRPHS60</b>	<b>PD180</b>
<b>Connections</b>	<b>Terminal block</b>	<b>Terminal block</b>	<b>Terminal block</b>
			
<b>Dimensions (mm)</b>	34 x 190 x 32	60 x 130 x 52	180 x 51 x 49
<b>Through-beam range</b>			
<b>Indoor sensing distance (max) m</b>	10	20 / 60	15 / 30
<b>General specifications</b>			
<b>Technology</b>	Infrared	Infrared	Infrared
<b>Supply voltage Receiver or Emitter</b>	12/24 VAC/VDC (depending on jumper insertion)	12/24 VAC/VDC (depending on jumper insertion)	12 + 24 VAC/DC
<b>Battery Supply Emitter</b>			2 x 3,6 VDC, 2100 mAh Lithium Batteries size AA
<b>Consumption</b>	60 mA to 24 VAC (tx + rx)	110 mA to 24 VAC (tx + rx)	35 mA DC (55 mA DC with low battery alarm)
<b>Output</b>	changeover relay SPDT	NO and NC with double relay in series	2 x SPST
<b>Contact rating</b>	1 A @ 24 VAC (resistive load)	1 A @ 24 VAC (resistive load)	1 A @ 30 VDC (resistive load)
<b>Approvals</b>	CE	CE	CE - UL325
<b>Conformity</b>	EN 12453, EN 954-1, RoHS	EN 12453, EN 954-1, RoHS	EN 12445, EN12453, EN12978, RoHS
<b>Test input</b>			Emitter test input
<b>Environmental specifications</b>			
<b>Wavelength</b>	950 nm	950 nm	850 nm
<b>Operating temperature</b>	-20°C to +60°C	-20°C to +60°C	-25°C to +55°C
<b>Degree of protection</b>	IP 54	IP 66	IP 55
<b>Mechanical specifications</b>			
<b>LED transmitter</b>	Power signal	Power signal	None (energy saving)
<b>LED receiver</b>	Signal for alignment with transmitter	Signal for alignment with transmitter	Power ON - Green LED Output - Yellow LED
<b>Optical adjustment</b>		Horizontal 180°	Horizontal 200° Vertical ±30°
<b>Mounting</b>	Wall or ceiling mounted type	Wall mounted type	Wall mounted type
<b>Weight</b>	310g (couple)	940g (couple)	Emitter 270g Receiver 230g
<b>Comments</b>			Emitter is supplied with 2 x 3.6 VDC 2100 mAh Lithium Batteries

# Photoelectric sensors

	Sensors	Amplifier 1-channel	Amplifier 2-channel	Amplifier 3-channel
<b>Types</b>	<b>MPF..</b>	<b>MPF1..</b>	<b>MPF2..</b>	<b>MPF3..</b>
<b>Connections</b>	<b>10 m cable</b>	<b>Terminals</b>	<b>Terminals</b>	<b>Terminals</b>



Dimensions (mm)	See sensor type	70 x 57 x 86	70 x 57 x 86	70 x 57 x 86
-----------------	-----------------	--------------	--------------	--------------

Amplifier	1-Channel	2-Channel	3-Channel
12-24 VAC/DC ±15% Low current	<b>MPF1-912RSL</b>	<b>MPF2-912RSL</b>	<b>MPF3-912RSL</b>
12-24 VAC/DC ±15%	<b>MPF1-912RS</b>	<b>MPF2-912RS</b>	<b>MPF3-912RS</b>
115 VAC ±15%	<b>MPF1-115RS</b>	<b>MPF2-115RS</b>	<b>MPF3-115RS</b>
230 VAC ±15%	<b>MPF1-230RS</b>	<b>MPF2-230RS</b>	<b>MPF3-230RS</b>

Through-beam emitter	Output and function selection			
Sensing distance (Sn)	15 m	No Dist Adjust		Dist Adjust
Ø12 x 20	<b>MPFT15-4 (C)</b>	Normal Mute	Inverted Mute	Normal Mute Inverted Mute
D11 x 24.5	<b>MPFT11-D11-4 (C)</b>			
D18 x 25	<b>MPFT15-D18-4 (C)</b>	RS	RSI	RSA RSAI
M14 x 23	<b>MPFT15-M14-4 (C)</b>	RSL	RSLI	RSLA RSLAI

Through-beam receiver	
Sensing distance (Sn)	15 m
Ø12 x 20	<b>MPFR-4 (C)</b>
D11 x 24.5	<b>MPFR-D11-4 (C)</b>
D18 x 25	<b>MPFR-D18-4 (C)</b>
M14 x 23	<b>MPFR-M14-4 (C)</b>

General specifications				
Rated operating voltage	Powered by amplifier	See amplifier reference	See amplifier reference	See amplifier reference
Output		1 x 2 SPST in series	2 x 2 SPST in series	3 x 2 SPST in series
Low current resistive load		RS type: 2 A @ 240 VAC / 30 VDC RSL type: 0.5 A @ 50 VAC / 30 VAC	RS type: 2 A @ 240 VAC / 30 VDC RSL type: 0.5 A @ 50 VAC / 30 VAC	RS type: 2 A @ 240 VAC / 30 VDC RSL type: 0.5 A @ 50 VAC / 30 VAC
Operating frequency	Amplifier dependent	10 Hz	10 Hz	10 Hz
Degree of protection	IP 67	IP 40	IP 40	IP 40
Protection Short-circuit (S) Reverse polarity (P) Transients (T)	SPT	PT	PT	PT
Housing material -Amplifier -Sensor Ø12+D11+D18 -Sensor	PC + ABS PC + Stainless steel	PC	PC	PC
Operating temperature	-20°C to +60°C	-20°C to +60°C	-20°C to +60°C	-20°C to +60°C
LED colour		Yellow	Yellow	Yellow
Approvals/Marks	CE - UL325 - UL508	CE - UL325 - UL508	CE - UL325 - UL508	CE - UL325 - UL508
Remarks	C = Pigtail connector version			
Optical angle (degrees)	±5			

# Photoelectric sensors

## Sensors for amplifiers

Types	MOF..	MOF.. ATEX	MNF..	MDF..
Connections	10 m cable	Terminals	Terminals	Terminals
				

Dimensions (mm)	Ø 10 x 42	Ø 10 x 42	Ø 20 x 80	Ø 13.5 x 55
-----------------	-----------	-----------	-----------	-------------

### Through-beam emitter

Sensing distance (Sn)	20 m	20 m		
Max. ±2° optical angle	<b>MOFT20</b> <b>MOFT20-M12-2</b>	<b>MOFT20AX</b> <b>MOFT20-M12-2AX</b>		
Sensing distance (Sn)	50 m			
Max. ±2° optical angle	<b>MOFT50</b> <b>MOFT50-M12-2</b>			
Sensing distance (Sn)	20 m	20 m		
Max. ±5° optical angle	<b>MOFT20-5</b> <b>MOFT20-M12-5</b>	<b>MOFT20-5AX</b> <b>MOFT20-M12-5AX</b>		
Sensing distance (Sn)	20 m	20 m	15 m	30 m
Max. ±8° optical angle	<b>MOFT20-8</b> <b>MOFT20-M12-8</b> <b>MOFT20-M14-8</b>	<b>MOFT20-8AX</b> <b>MOFT20-M12-8AX</b> <b>MOFT20-M14-8AX</b>	<b>MNFT15</b>	<b>MDFT30</b>



### Through-beam receiver

Operating frequency	Amplifier dependent	Amplifier dependent	Amplifier dependent	Amplifier dependent
Sensing distance (Sn)	See emitter	See emitter	See emitter	See emitter
Max. ±2° optical angle	<b>MOFR</b> <b>MOFR-M12-2</b>	<b>MOFRAX</b> <b>MOFR-M12-2AX</b>		
Max. ±5° optical angle	<b>MOFR-5</b> <b>MOFR-M12-5</b>	<b>MOFR-5AX</b> <b>MOFR-M12-5AX</b>		
Max. ±8° optical angle	<b>MOFR-8</b> <b>MOFR-M12-8</b> <b>MOFR-M14-8</b>	<b>MOFR-8AX</b> <b>MOFR-M12-8AX</b> <b>MOFR-M14-8AX</b>	<b>MNFR15</b>	<b>MDFR30</b>





### General specifications

Rated operating voltage	Powered by Amplifier	Powered by Amplifier	Powered by Amplifier	Powered by Amplifier
Output	On Amplifier	On Amplifier	On Amplifier	On Amplifier
Operating frequency	See Amplifier type: S142.. - S143.. - PAM..	See Amplifier type: S142.. - S143.. - PAM..	See Amplifier type: S142.. - S143.. - PAM..	See Amplifier type: S142.. - S143.. - PAM..
Degree of protection	IP 66 - IP 67	IP 66 - IP 67	IP 67	IP 67
Protection Short-circuit (S) Reverse polarity (P) Transients (T)	SPT	SPT	SPT	SPT
Housing material sensor	Ø10: PC M14 + M14: PC + SS	Ø10: PC M14 + M14: PC + SS	PC M14 + M14: PC + SS	Acetal, glass reinforced
Operating temperature	-20°C to +60°C	-20°C to +60°C	-20°C to +60°C	-20°C to +60°C
LED colour	None	None	None	None
Approvals/Marks	CE	CE - ATEX	CE	CE

# Photoelectric sensors



Types		Amplifiers for sensors		
Connections	11-pole plug	11-pole plug	11-pole plug	11-pole plug
				
Dimensions (mm)	35 x 80 x 81.5	35 x 80 x 81.5	35 x 80 x 81.5	35 x 80 x 81.5
Description	Standard amplifier with Sensor diagnostics and adjustable sensing distance	As S142A but with adjustable time delay	As S142A but with Master / Slave function for high neighbour immunity	
<b>References amplifier</b>				
1 x SPDT relay	<b>S142ARNN924</b>	<b>S142BRNN924</b>		
1 x NPN Output	<b>S142ARNN024</b>	<b>S142BRNN024</b>		
1 x NPN Alarm Output	<b>S142ARNN115</b> <b>S142ARNN230</b>	<b>S142BRNN115</b> <b>S142BRNN230</b>		
1 x SPDT relay	<b>S142ARNT924</b>	<b>S142BRNT924</b>		
1 x NPN Output or alarm	<b>S142ARNT024</b>			
1 x Emitter mute input	<b>S142ARNT115</b> <b>S142ARNT230</b>	<b>S142BRNT115</b> <b>S142BRNT230</b>		
1 x PNP Output	<b>S142APPT924</b>	<b>S142BPPT924</b>		
1 x PNP Alarm Output	<b>S142APPT115</b>	<b>S142BPPT115</b>		
1 x Emitter mute input	<b>S142APPT230</b>	<b>S142BPPT230</b>		
1 x SPDT relay			<b>S142CRXA924</b>	
A - Auto distance adjustment			<b>S142CRXA115</b> <b>S142CRXA230</b>	
M - Manual distance adjustment			<b>S142CRXM924</b> <b>S142CRXM115</b> <b>S142CRXM230</b>	
<b>General specifications</b>				
Rated operating voltage				
924	24 VAC/DC	24 VAC/DC	24 VAC/DC	
115	115 VAC	115 VAC	115 VAC	
230	230 VAC	230 VAC	230 VAC	
Relay load current resistive load	10 A @ 250 VAC / 25 VDC SPD	10 A @ 250 VAC / 25 VDC SPD	10 A @ 250 VAC / 25 VDC SPD	
Transistor Load current	100 mA 40 VDC	100 mA 40 VDC		
Operation frequency	20 Hz	20 Hz, no timer	15 Hz @ 2 systems 4 Hz @ 6 systems	
Degree of protection	IP 20	IP 20	IP 20	
Protection Short-circuit (S)				
Reverse polarity (P)	SPT	SPT	S	
Transients (T)				
Housing material	Noryl SE1, Light grey	Noryl SE1, Light grey	Noryl SE1, Light grey	
Operating temperature	-20°C to +50°C	-20°C to +50°C	-20°C to +50°C	
Approvals/Marks	CE - UL - CSA	CE - UL - CSA	CE - UL - CSA	

# Photoelectric sensors



Types	S1430 UAP..	S1430 RAL..	S1430 ROS..	PAM...
Connections	1 1-pole plug	11-pole plug	11-pole plug	Terminals
				
Dimensions (mm)	35 x 80 x 81.5	35 x 80 x 81.5	35 x 80 x 81.5	2, 3, 4, 5, 6 DIN housing
Description	3 input 3 transistors outputs	3 input 3 transistors outputs	3 input 3 double relay outputs	2-4-6-8 or 10 channel modular system
<b>References amplifier</b>				
12-30 VAC/DC $\pm 15\%$	<b>S1430UAP912</b>			
15-30 VAC/DC $\pm 10\%$		<b>S1430RAL915</b>	<b>S1430ROS915</b>	
No. of channels				2 channels
- NPN output, NO				<b>PAM02AN3ANO/NC</b>
- PNP output, NO				<b>PAM02AN3APO/PC</b>
No. of channels				4 channels
- NPN output, NO				<b>PAM04AN3ANO/NC</b>
- PNP output, NO				<b>PAM04AN3APO/PC</b>
No. of channels				6 channels
- NPN output, NO				<b>PAM06AN3ANO/NC</b>
- PNP output, NO				<b>PAM06AN3APO/PC</b>
<b>References extension modules</b>				
No. of channels				2 channels
- NPN output, NO				<b>PAM02CN3ANO</b>
- NPN output, NC				<b>PAM02CN3ANC</b>
- PNP output, NO				<b>PAM02CN3APO</b>
- PNP output, NC				<b>PAM02CN3APC</b>
No. of channels				4 channels
- NPN output, NO				<b>PAM04CN3ANO</b>
- NPN output, NC				<b>PAM04CN3ANC</b>
- PNP output, NO				<b>PAM04CN3APO</b>
- PNP output, NC				<b>PAM04CN3APC</b>
<b>General specifications</b>				
Rated operating voltage	See Amplifier type	See Amplifier type	See Amplifier type	18 - 33 VDC
Output	3 x Transistor NPN/PNP/NO/NC	3 x SPST	3 x SPST	One output per channel
Load current resistive load	100 mA, 40 VDC, NPN	1.5 A @ 100 VAC / 30 VDC	1.5 A @ 100 VAC / 30 VDC	20 mA, 33 VDC, NPN / PNP 8 A @ 250 VAC / 24 VDC SPDT resistive load
Operation frequency	16 Hz	12.5 Hz	12.5 Hz	30 Hz @ 6 channels
Degree of protection	IP 20	IP 20	IP 20	IP 20
Protection Short-circuit (S)				
Reverse polarity (P)	SPT	PT	PT	SPT
Transients (T)				
Housing material	Noryl SE1, Light grey	Noryl SE1, Light grey	Noryl SE1, Light grey	
Operating temperature	-20°C to +50°C	-20°C to +50°C	-20°C to +50°C	-20°C to +50°C
LED colour	Yellow + Green + Red	Yellow + Green + Red	Yellow + Green + Red	Yellow + Green + Red
Approvals/Marks	Multiplexed system	Multiplexed system	Multiplexed system	Multiplexed system, Test functions, bargraph, mute input etc.



# Photoelectric sensors

Types	Wireless entrapment protection device for industrial doors ESPE		
Connections	Main controller	Subcontroller	PB 11
			
Dimensions (mm)	35 x 35 x 125	26 x 242 x 45	Ø11 x 24.5
Description	The Carlo Gavazzi main controller can control up to 4 subcontrollers	This flexible Carlo Gavazzi subcontroller can handle 2 safety edges and 1 door-in-door limit switch	
References			
Main controller	<b>WSM 2 B A 2 D24</b>		
Subcontroller	<b>WSS 2 B A 2 BAT</b>		
Photoelectric sensor Emitter	<b>PB 11 CNT 15 WE</b>		
Photoelectric sensor Receiver	<b>PB 11 CNT 15 WR</b>		
General specifications			
Rated operating voltage	12 - 24 VAC/DC	1 - 4 Lithium 3.6 VDC size AA batteries	From sub controller
Supply current	< 50 mA		
Relay load current resistive load	1A / 30 VDC 0.5 A / 30 VAC		
Communication frequency	2.4 GHz Duplex	2.4 GHz Duplex	
Response time	120 mS	120 mS	
Number of channels	16	16	
Communication distance	10 m wireless	10 m wireless	
Sensing distance			15 m
Subcontroller up-time		10 - 80 sec	
Test input	On main module		
Degree of protection	IP 66	IP 66	IP 67
Protection Short-circuit (S) Reverse polarity (P) Transients (T)	PT	P	
Housing material	ABS, Light grey	PC, Light grey	PA6 Glass reinforced
Operating temperature	-25°C to +55°C	-25°C to +55°C	-25°C to +55°C
LED colour	Green, Yellow, Red	Yellow	-
Approvals/Marks	CE - UL - FCC	CE - UL - FCC	CE - UL

## Photoelectric sensors

Types	Wireless entrapment protection device for industrial gates ESPE		
Connections	Main controller	Subcontroller	PB 11
			
Dimensions (mm)	35 x 35 x 125	26 x 242 x 45	Ø11 x 24.5
Description	The Carlo Gavazzi main controller can control up to 6 subcontrollers	This flexible Carlo Gavazzi subcontroller can handle one opening safety edge and one closing edge	
References			
Main controller (N.O. 8.2 kohm output)	<b>WSM6GAOOD24</b>		
Main controller (N.C. output)	<b>WSM6GACCD24</b>		
Subcontroller	<b>WSS2GA2BAT</b>		
Photoelectric sensor Emitter			<b>PB 11 CNT 15 WE</b>
Photoelectric sensor Receiver			<b>PB 11 CNT 15 WR</b>
General specifications			
Rated operating voltage	12 - 24 VAC/DC	1 - 4 Lithium 3.6 VDC size AA batteries	From sub controller
Supply current	< 50 mA		
Relay load current resistive load	1A / 30 VDC 0.5 A / 30 VAC		
Communication frequency	2.4 GHz Duplex	2.4 GHz Duplex	
Response time	From 15 to 100 ms	From 15 to 100 ms	
Number of channels	16	16	
Communication distance	15 m wireless	15 m wireless	
Sensing distance			2.5 m
Subcontroller up-time	15 – 105 s, fixed time or infinite		
Test input	On main module		
Degree of protection	IP 66	IP 66	IP 67
Protection Short-circuit (S) Reverse polarity (P) Transients (T)	PT	P	
Housing material	ABS, Light grey	PC, Light grey	PA6 Glass reinforced
Operating temperature	-25°C to +55°C	-25°C to +55°C	-25°C to +55°C
LED colour	Green, Yellow, Red	Yellow	-
Approvals/Marks	CE - UL - FCC - TÜV	CE - UL - FCC - TÜV	CE - UL

# Photoelectric level sensors

Integrated amplifier			
Types	VPO.E.	VP ATEX	VP E.M
Connections	2 m cable	2 m cable	2 m cable
			
Dimensions (mm)	3/8" x 74	3/8" x 74	3/8" x 74
Light type	Unmodulated	Unmodulated	Unmodulated
References optical level sensor			
Operating frequency	30 Hz	30 Hz	30 Hz
Sensing dist. (Sn), Hor.	± 5 mm, fixed	± 5 mm, fixed	± 5 mm, fixed
Sensing dist. (Sn), Ver.	± 2.5 mm, fixed	± 2.5 mm, fixed	± 2.5 mm, fixed
Housing material	Polysulphone	Polysulphone	Polysulphone
NPN NO	<b>VPO2E</b>		<b>VPO2EM</b>
NPN NC	<b>VP01E</b>		<b>VP01EM</b>
PNP NO	<b>VPO2EP</b>	<b>VPO2EPAX</b>	<b>VPO2EPM</b>
PNP NC	<b>VP01EP</b>	<b>VP01EPAX</b>	<b>VP01EPM</b>
Housing material	Polyamide 12	Polyamide 12	Polyamide 12
NPN NO	<b>VP04E</b>		<b>VP04EM</b>
NPN NC	<b>VP03E</b>		<b>VP03EM</b>
PNP NO	<b>VP04EP</b>	<b>VP04EPAX</b>	<b>VP04EPM</b>
PNP NC	<b>VP03EP</b>	<b>VP03EPAX</b>	<b>VP03EPM</b>
Housing material	Polysulphone		
SCR NO	<b>VP02-110TB</b>		
SCR NC	<b>VP01-110TB</b>		
SCR NO	<b>VP02-230TB</b>		
SCR NC	<b>VP01-230TB</b>		
DC-types			
Rated operating voltage	10 - 40 VDC	10 - 40 VDC	10 - 40 VDC
Voltage drop	≤ 1.0 VDC	≤ 1.0 VDC	≤ 1.0 VDC
Off-state current	≤ 12 mA	≤ 12 mA	≤ 12 mA
Load current	< 200 mA	< 200 mA	< 200 mA
AC-types (SCR)			
Rated operating voltage	110 or 230 VAC	110 or 230 VAC	110 or 230 VAC
Voltage drop	≤ 9 VAC	≤ 9 VAC	≤ 9 VAC
Off-state current	≤ 7 mA	≤ 7 mA	≤ 7 mA
Load current	< 10 - 100 mA	< 10 - 100 mA	< 10 - 100 mA
AC-types (SCR)			
Degree of protection	IP 67	IP 67	IP 67
Protection Short-circuit (S) Reverse polarity (P) Transients (T)	PT	PT	PT
Operating temperature	-20°C to +80°C	-20°C to +80°C	-20°C to +80°C
LED colour	Yellow	Yellow	Yellow
Pressure	10 bar @ +60°C	10 bar @ +60°C	10 bar @ +60°C
Approvals/Marks	CE - UL - CSA	CE - UL - CSA	CE - UL - CSA

# Photoelectric level sensors

## Integrated amplifier

Types	VPA..../VPB....	VPA....-1/VPB....-1
Connections	2 m cable	M12 connector

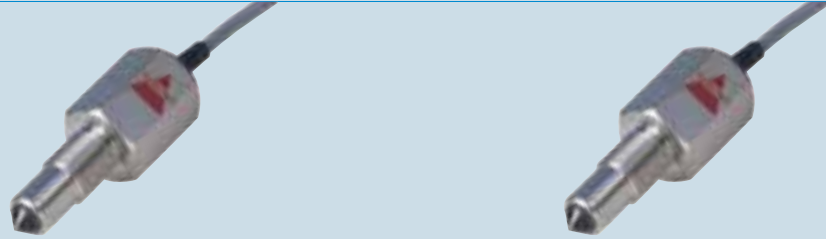

Dimensions (mm)	3/8" x 70.5	3/8" x 90.5
Light type	Modulated	Modulated

### References optical level sensor

Operating frequency	30 Hz	30 Hz
Sensing dist. (Sn), Hor.	± 5 mm, fixed	± 5 mm, fixed
Sensing dist. (Sn), Ver.	± 2.5 mm, fixed	± 2.5 mm, fixed
Housing material	Stainless steel/polysulphone	Stainless steel/polysulphone
NPN NO+NC	<b>VPA1MNA</b>	<b>VPA1MNA-1</b>
PNP NO+NC	<b>VPA1MPA</b>	<b>VPA1MPA-1</b>
Housing material	Stainless steel and glass	Stainless steel and glass
NPN NO+NC	<b>VPA2MNA</b>	<b>VPA2MNA-1</b>
PNP NO+NC	<b>VPA2MPA</b>	<b>VPA2MPA-1</b>
Housing material	Nickel-pl. brass/polysulphone	Nickel-pl. brass/polysulphone
NPN NO+NC	<b>VPB1MNA</b>	<b>VPB1MNA-1</b>
PNP NO+NC	<b>VPB1MPA</b>	<b>VPB1MPA-1</b>
Housing material	Nickel-plated brass and glass	Nickel-plated brass and glass
NPN NO+NC	<b>VPB2MNA</b>	<b>VPB2MNA-1</b>
PNP NO+NC	<b>VPB2MPA</b>	<b>VPB2MPA-1</b>

### DC-types

Rated operational voltage	10 - 40 VDC	10 - 40 VDC
Voltage drop	≤ 2.5 VDC	≤ 2.5 VDC
Off-state current	≤ 7 mA	≤ 7 mA
Load current	< 200 mA	< 200 mA

### General specifications

Degree of protection	IP 67	IP 67
Protection Short-circuit (S) Reverse polarity (P) Transients (T)	SPT	SPT
Operating temperature	-20°C to +80°C	-20°C to +80°C
LED colour	Yellow	No LED
Pressure	10 bar @ +60°C	10 bar @ +60°C
Approvals/Marks	CE - UL - CSA	CE - UL - CSA

# Photoelectric sensors accessories

## Reflectors, rectangular



Item Number	<b>ER100</b>	<b>ER840</b>	<b>ER681</b>	<b>ER686</b>
Dimensions (mm)	100 x 100 x 9.2	84.5 x 84.5 x 9	52 x 119 x 27	55.3 x 126 x 9
Mounting (screws not incl.)	2 x M3 screws	2 x M3.5 screws	4 x M4 screws	2 x M6 screws
Reduction factor	1.2	0.96	0.92	0.92

## Reflectors, rectangular



Item Number	<b>ER4060</b>	<b>ER5060</b>	<b>ER42182</b>	<b>ER5080</b>
Dimensions (mm)	60 x 41 x 8	55.5 x 61 x 8	186 x 46.5 x 8	80 x 54 x 8
Mounting (screws not incl.)	2 x M3.5 screws	2 x M4 screws	2 x M6 screws	Adhesive
Reduction factor	0.81	0.80	0.65	0.60

## Reflectors, rectangular

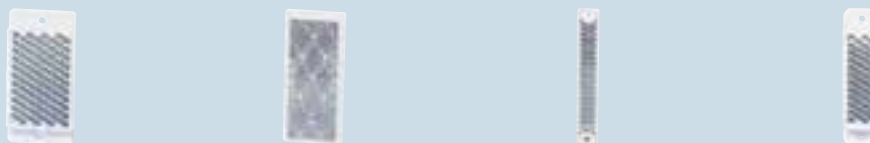

Item Number	<b>ER483</b>	<b>ER8</b>	<b>ER665</b>	<b>ER530</b>
Dimensions (mm)	32.5 x 65 x 8	82 x 37 x 5.5	18.5 x 120 x 65	19 x 72.5 x 8.4
Mounting (screws not incl.)	2 x M3.5 screws	Adhesive	2 x M4 screws	2 x M3.5 screws
Reduction factor	0.55	0.51	0.45	0.45

## Reflectors, rectangular

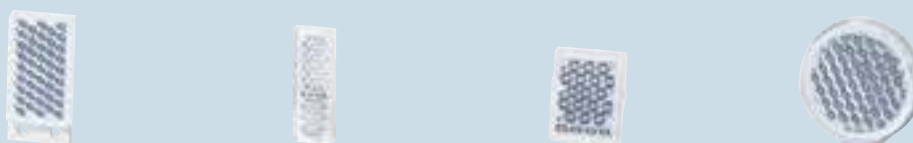

Item Number	<b>ER390</b>	<b>ER1</b>	<b>ER640</b>	<b>ER692</b>
Dimensions (mm)	23.5 x 47.5 x 8	51 x 17.5 x 5	13 x 17 x 5	Ø 35 x 5.5
Mounting (screws not incl.)	2 x M3.5 screws	Adhesive	Adhesive	Adhesive
Reduction factor	1.39	0.20	0.16	0.53

## Reflectors, cylindrical

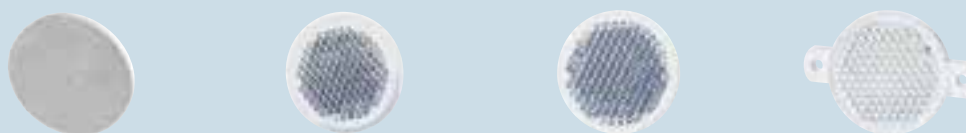

Item Number	<b>ER4</b>	<b>ER460</b>	<b>ER420</b>	<b>ER423</b>
Dimensions (mm)	Ø 84 x 7.4	Ø 46 x 6.5	Ø 42 x 6.3	Ø 41.5 x 6
Mounting (screws not incl.)	1 x M4 screw	Adhesive	Adhesive	2 x M3 screws
Reduction factor	1	0.55	0.54	0.54

# Photoelectric sensors accessories

## Reflectors, cylindrical



Item Number	<b>ER689</b>
Dimensions (mm)	Ø 25 x 5.5
Mounting (screws not incl.)	Adhesive
Reduction factor	0.39

## Micro cube reflectors for LD32



Item Number	<b>EM 130-20</b>
Dimensions (mm)	20 x 43
Mounting (screws not incl.)	2 x M3 screws
Reduction factor	1 (Micro Cube)



Item Number	<b>EM 120-20</b>
Dimensions (mm)	20 x 32
Mounting (screws not incl.)	2 x M3.5 screws
Reduction factor	1 (Micro Cube)



Item Number	<b>EM 123-70</b>
Dimensions (mm)	13.7 x 23
Mounting (screws not incl.)	2 x M2 screws
Reduction factor	1 (Micro Cube)

## Reflectors, tape

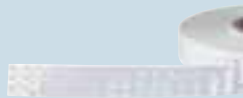

Item Number	<b>ERT25</b>
Dimensions (mm)	25 mm x 45.7 m
Mounting (screws not incl.)	Adhesive
Reduction factor	0.23 (25 x 25 mm)



Item Number	<b>EM 111-40</b>
Dimensions (mm)	10.5 x 10.5
Mounting (screws not incl.)	Adhesive
Reduction factor	1 (Micro Cube)



Item Number	<b>EM 121-41</b>
Dimensions (mm)	Ø20
Mounting (screws not incl.)	Adhesive
Reduction factor	1 (Micro Cube)



Item Number	<b>EM 110-40</b>
Dimensions (mm)	Ø10
Mounting (screws not incl.)	Adhesive
Reduction factor	1 (Micro Cube)

## Reflectors, tape



Item Number	<b>ERT50</b>
Dimensions (mm)/Used for	50 mm x 45.7 m
Mounting (screws not incl.)	Adhesive
Reduction factor/Description	0.34 (50 x 50 mm)



Item Number	<b>AMPF-MB1</b>
Dimensions (mm)/Used for	MPFT15-4 & MPFR-4
Mounting (screws not incl.)	Adhesive
Reduction factor/Description	Plastic mounting bracket for wall mounting



Item Number	<b>AMPF-MB2</b>
Dimensions (mm)/Used for	MPFT15-4 & MPFR-4
Mounting (screws not incl.)	Adhesive
Reduction factor/Description	Adaptor for fitting to an Ø18 mm rubber profile



Item Number	<b>AMPF-MB3</b>
Dimensions (mm)/Used for	MPFT15-4 & MPFR-4
Mounting (screws not incl.)	Adhesive
Reduction factor/Description	Metal mounting bracket for harsh environment

## Accessories, photoelectric sensors



Item Number	<b>APA18-AK</b>
Used for	M18 photoelectrics
Description	Ø2, Ø4, and Ø8 mm aperture



Item Number	<b>APA18-RAR</b>
Used for	M18 photoelectrics
Description	90° mirror for angle detection



Item Number	<b>610DC</b>
Used for	S1430...
Description	Plug conversion



Item Number	<b>APA3</b>
Used for	PA.. sensors
Description	Mounting bracket in anodized aluminium

## Accessories, photoelectric sensors



Item Number	<b>FPD..S.. / FPT..S..</b>
Dimensions (mm)	1 mm fiber
Used for	PD60CNX.. EF1810..
Description	Plastic fibre optics. Separate fibre heads see datasheet

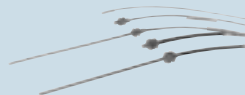

Item Number	<b>FPD..S.. / FPT..S..</b>
Dimensions (mm)	0.25 to 1 mm fiber
Used for	PD60CNX.. EF1810..
Description	Plastic fibre optics. Various fibre heads see datasheet





Item Number	<b>FGD..S.. / FGT..S..</b>
Dimensions (mm)	1 mm fiber
Used for	PD60CNV..
Description	Glass fibre optics. Various fibre heads see datasheet



Item Number	<b>MB-M01</b>
Dimensions (mm)	MOE.. sensors
Used for	MOE.. sensors
Description	Ball mounting bracket for flexible mounting

# Photoelectric sensors accessories

## Brackets

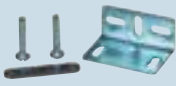
				
Item Number	<b>APA-2</b>	<b>APB-1</b>	<b>MB02</b>	<b>APD32-MB3</b>
Used for	PA.. sensors	PB	PM	PD32 - LD32
Description	Mounting bracket in steel, black	Mounting bracket in steel, black	Long mounting bracket for wall mounting in steel, chromated	Mounting bracket in steel, chromated

## Brackets

				
Item Number	<b>APD30 MB1</b>	<b>APD30 MB2</b>	<b>ACP50-1</b>	
Used for	PD.. sensors	PD.. sensors	PC50.. sensors	M18 sensors
Description	Mounting bracket in steel, chromated	Mounting bracket in steel, chromated	Mounting bracket in steel, chromated	Mounting bracket in plast

## Brackets

		
Item Number	<b>APA18-MB1</b>	<b>APH18-MB1</b>
Used for	PA18 sensors	PH18 sensors
Description	Mounting bracket in plast	Mounting bracket in plast

## Conductive level sensors

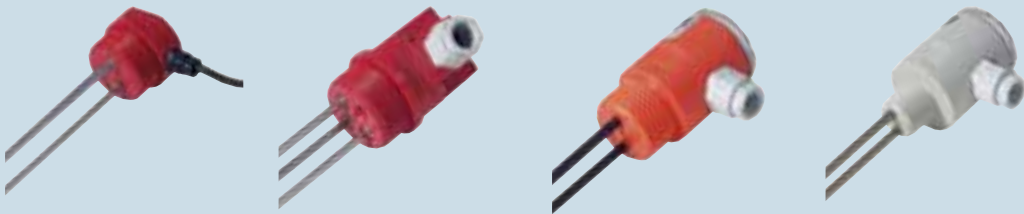
Types	VN / VNI		VNY / VNYI		VPC		VPP	
Connections	Cable (PVC) 2 m		Screw connection		Screw connection		Screw connection	
								
<b>Electrodes</b>								
Number of electrodes	1, 2, 3 or 4		1, 2, 3 or 4		1, 2 or 3		1, 2 or 3	
Diameter/length (mm)	D5/1000		D5/1000		D4/500		D4/500	
Material	Stainless steel		Stainless steel		Stainless steel		Stainless steel	
Isolation of electrodes	Yes (VNI)		Yes (VNYI)		Yes		Yes	
Isolation	Polyethylene		Polyethylene		Polyethylene		PVDF	
<b>Housing</b>								
Pipe thread	1½"		1½"		½" (VPC x05) or 1" (VPC x10)		½" (VPC x05) or 1" (VPC x10)	
Material	Nylon 6		Nylon 6		PVC		Polypropylene	
<b>References</b>								
1 electrodes	<b>VN1</b>	<b>VNI1</b>	<b>VNY1</b>	<b>VNYI1</b>	<b>VPC105</b>	<b>VPC110</b>	<b>VPP105</b>	<b>VPP110</b>
2 electrodes	<b>VN2</b>	<b>VNI2</b>	<b>VNY2</b>	<b>VNYI2</b>	<b>VPC205</b>	<b>VPC210</b>	<b>VPP205</b>	<b>VPP210</b>
3 electrodes	<b>VN3</b>	<b>VNI3</b>	<b>VNY3</b>	<b>VNYI3</b>	<b>VPC310</b>		<b>VPP310</b>	
4 electrodes	<b>VN4</b>	<b>VNI4</b>	<b>VNY4</b>	<b>VNYI4</b>				
<b>Specifications</b>								
Degree of protection	IP 67		IP 67		IP 67		IP 67	
Operating temperature	0°C to +90°C		0°C to +90°C		0°C to +60°C		0°C to +100°C	
Approvals/Marks	CE		CE		CE		CE	



## Conductive level sensors

Types	VT / VTI	CLH	VH1 / VH2	A 94-10
Connections	Cable (Silicone)	Screw connection	Cable (Neoprene)	Cable (PVC)
				

### Electrodes

Number of electrodes	1, 2, 3 or 4	2 or 4 + reference	1 (hanging)	2 (hanging)
Diameter/length (mm)	D5/1000	D4	D18/36.5 or D32/75.5	D22/75.0
Material	Stainless steel	Stainless steel	Stainless steel	Stainless steel
Isolation of electrodes	Yes (VTI)	Yes	No (VH1) - Yes (VH2)	No
Isolation	Teflon	Kynar, Polyolefine	Nylon 6	

### Housing

Pipe thread	1½"	1½"		
Material	Teflon	Polypropylene	Nylon 6	Polyester

### References

1 electrodes	VT1	VTI1	VH1 or VH2	
2 electrodes	VT2	VTI2		A 94-10
3 electrodes	VT3	VTI3	CLH3*	
4 electrodes	VT4	VTI4		
5 electrodes			CLH5*	

### Specifications





Degree of protection	IP 67	IP 65	IP 67	IP 67
Operating temperature	0°C to +145°C	-20°C to +90°C	0°C to +90°C	0°C to +60°C
Approvals/Marks	CE	CE	CE	CE

### Electrodes (Stainless steel ANSI316)





No Insulation	
1 m	CLE1
2 m	CLE2
Extension 1 m	CLE1X
Kynar (DVDP) Insulation	
1 m	CLE1K
2 m	CLE2K
Extension 1 m	CLE1KX
Polyolefine Insulation	
1 m	CLE1P
2 m	CLE2P
Extension 1 m	CLE1PX

\* Electrodes shall be ordered separately



## Conductive level sensors

Level controller				
Types	CLD1	CLD2	CLP2 Basic	CLP2
Connections	DIN rail	DIN rail	Plug 11 pin circular	Plug 11 pin circular
				
Function	Filling or emptying. Selectable by rotary switches. Conductive liquids	Filling or emptying. Selectable by rotary switches. Conductive liquids	Filling or emptying. Selectable by rotary switches. Conductive liquids	Filling or emptying. Selectable by rotary switches. Conductive liquids
Adjustable	Yes, Potentiometer	Yes, Potentiometer	Yes, Potentiometer	Yes, Potentiometer
Sensitivity	5 K $\Omega$ to 150 K $\Omega$	250 $\Omega$ to 500 K $\Omega$	5 K $\Omega$ to 150 K $\Omega$	250 $\Omega$ to 500 K $\Omega$
Functions switch	- Timer 1 to 30 sec. delay on filling or/and emptying	- Filling / Emptying - 3-levels: Low, Standard and High	- Filling / Emptying	- Filling / Emptying - 3-levels: Low, Standard and High
Input	1 + reference	2 + reference	2 + reference	2 + reference
Output	8 A / 250 VAC SPST	8 A / 250 VAC SPDT	8 A / 250 VAC SPDT	8 A / 250 VAC DPDT
Power Supply	24 V AC/DC	24 - 240 VAC/DC	24 VDC, 24VAC, 115 VAC or 230 VAC	24 VAC/DC, 115 VAC or 230 VAC
References				
24 240 VAC/DC		<b>CLD2EB1BU24</b>		
24 VDC			<b>CLP2EB1B724</b>	
24 VAC			<b>CLP2EB1B024</b>	
24 VAC/DC	<b>CLD1EA1CM24</b>			<b>CLP2EA1CM24</b>
115 VAC			<b>CLP2EB1B115</b>	<b>CLP2EA1C115</b>
230 VAC			<b>CLP2EB1B230</b>	<b>CLP2EA1C230</b>
Specifications				
Time delay	< 300 mS	< 2S	< 2S	< 300 mS
Housing material	ABS VO	PA66	NORYL PPO	NORYL PPO
Operating temperature	-20°C to +50°C	-20°C to +50°C	-20°C to +50°C	-20°C to +50°C
Output LED colour	Yellow	Yellow	Yellow	Yellow
Power LED colour	Green	Green	Green	Green
Approvals/Marks	CE - UL - CSA	CE - cULus	CE - UL - CSA	CE - UL - CSA

## Conductive level sensors

Level controller				
Types	CLD2	CLP2 Master-Slave	CLD4	CLP4
Connections	DIN rail	Plug 11 pin circular	DIN rail	Plug 11 pin circular
				
Function	Filling or emptying. Selectable by rotary switches. Conductive liquids	Filling or emptying. Selectable by rotary switches. Conductive liquids Master - Slave system	Filling, emptying or combinations. Selectable by rotary switches. Conductive liquids	Filling, emptying or combinations. Selectable by rotary switches. Conductive liquids
Adjustable	Yes, Potentiometer	Yes, Potentiometer	Yes, Potentiometer	Yes, Potentiometer
Sensitivity	250 Ω to 500 KΩ	250 Ω to 500 KΩ	250 Ω to 500 KΩ	250 Ω to 500 KΩ
Functions switch	- Filling / Emptying - 3-levels: Low, Standard and High	- Filling / Emptying - 3-levels: Low, Standard and High	- Tank - well - Direct in to out 2 probe - Low and High alarm - 2 system in one, filling and/ or emptying - 3-levels: Low, Standard and High	- Tank - well - Direct in to out 2 probe - Low and High alarm - 2 system in one, filling and/ or emptying - 3-levels: Low, Standard and High
Input	2 + reference	2 + reference	2 to 4 + reference	2 to 4 + reference
Output	8 A / 250 VAC DPDT	8 A / 250 VAC SPDT	8 A / 250 VAC SPDT, SPST	8 A / 250 VAC 2 X SPST
Power Supply	24 VAC/DC, 115 VAC or 230 VAC	24 VAC/DC, 115 VAC or 230 VAC	24 VAC/DC, 115 VAC or 230 VAC	24 VAC/DC, 115 VAC or 230 VAC
<b>References</b>				
24 VAC/DC	<b>CLD2EA1CM24</b>	<b>CLP2FA1BM24</b>	<b>CLD4MA2DM24</b>	<b>CLP4MA2AM24</b>
115 VAC	<b>CLD2EA1C115</b>	<b>CLP2FA1B115</b>	<b>CLD4MA2D115</b>	<b>CLP4MA2A115</b>
230 VAC	<b>CLD2EA1C230</b>	<b>CLP2FA1B230</b>	<b>CLD4MA2D230</b>	<b>CLP4MA2A230</b>
<b>Specifications</b>				
Time delay	< 300 mS	< 300 mS	< 300 mS	< 300 mS
Housing material	ABS VO	NORYL PPO	ABS VO	NORYL PPO
Operating temperature	-20°C to +50°C	-20°C to +50°C	-20°C to +50°C	-20°C to +50°C
Output LED colour	Yellow	Yellow	Yellow	Yellow
Power LED colour	Green	Green	Green	Green
Approvals/Marks	CE - UL - CSA	CE - UL - CSA	CE - UL - CSA	CE - UL - CSA

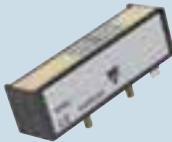
## Proximity magnetic sensors, rectangular

Rectangular			
Types	S series	SPB2 series	SPA1 series
			
Dimensions (mm)	11.5 x 79 x 21.2	25.5 x 85 x 24	16 x 90 x 20
<b>Electrical specifications</b>			
Max. switch. voltage contact	250 VAC [SA / SC 2, SB2 / -S5] 1500 VAC [SA / SC 8] 230 VAC [SS2, S.BS.2]	250 VAC	24 VDC [output 1 and 2]
Max. switch. current contact	1 A [SS2, S.BS.2] 3 A [SA2, SC2, SB2, SB2S5, SA8, SC8]	3 A	0.5 A [output 1] 4 A [output 2]
Max. switch. power contact	100 VA [SA / SC 2, SB2 / -S5] 120 VA [SA / SC 8] 60 VA [SS2, S.BS.2]	100 VA	5 VA [output 1] 100VA [output 2]
Power supply			24 VDC
<b>General specifications</b>			
Operating distance	5 - 32 mm	5 - 30 mm	12 mm
Output connection	PVC cable, 0.5 m (0.24 m Type S5)	Faston [SPB2] 2 m PVC Cable [SPB22MT]	PVC cable, 19 cm Pig-tail
Degree of protection	IP 67	IP 67 [SPB22MT] IP 65 [SPB2]	IP 67
Operating temperature	-25°C to +75°C	-25°C to +75°C	-25°C to +80°C
Housing material	Plastic	Plastic	ABS class V0
<b>References</b>			
Normally open	SA2 SA8		
Normally closed	SC2 SC8		
Change - Over	SS2		
Bistable	SB2 SB2S5	SPB2 SPB22MT	
Bistable CO	S.BS.2		
Normally closed, 2 outputs			SPA1S2 SPA1S3

# Proximity magnetic sensors, rectangular

## Rectangular

Types	M and MS series	MM series
-------	-----------------	-----------



Dimensions (mm)	8.3 x 37 x 16	6.1 x 23.5 x 14 [A6] 7 x 27 x 11 [A3, S1]
-----------------	---------------	--

### Electrical specifications

Max. switch. voltage contact	100 VAC [MS1] 230 VAC [MSA1] 500 VAC [MA3, MC3]	100 VAC [S1, A6] 500 VAC [A3]
Max. switch. current contact	0.25 A [MS1] 0.5 A [MA3, MC3] 0.75 A [MSA1]	0.25 A [S1] 0.5 A [A3, A6]
Max. switch. power contact	5 VA [MS1] 10 VA [MSA1, MA3, MC3]	5 VA [S1] 10 VA [A3, A6]

### General specifications

Operating distance	7 - 35 mm	10 - 40 mm
Output connection	PVC cable, 0.5 m (2 m, Type MSA1)	PVC cable [A3, S1] Twin lead cable [A6]
Degree of protection	IP 67	IP 67
Operating temperature	-25°C to +75°C	-25°C to +75°C
Housing material	Plastic	Plastic

### References

Normally open	<b>MSA1</b> <b>MA3</b>	<b>MMA3</b> <b>MMA6</b>
Normally closed	<b>MC3</b>	
Change - Over	<b>MS1</b>	<b>MMS1</b>

# Proximity magnetic sensors, cylindrical

## Cylindrical

### Types

### FM... series

### FMM... series

### FMMP... series

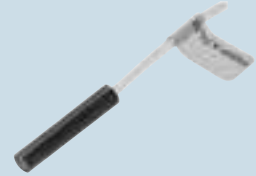
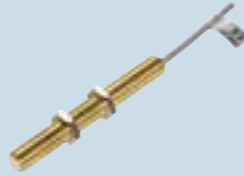

Dimensions (mm)	Ø 9.3 [A3, C3, S1] M10 x 0.75 [A3S5, A6] M12 x 1 [C3S1, A9S1]	M8 x 1	Ø 6 x 25 [L25] Ø 6 x 33 [L33] Ø 6 x 38 [L38]
-----------------	---	--------	--

### Electrical specifications

Max. switch. voltage contact	100 VAC [S1, A6] 230 VAC [A9S1] 500 VAC [A3, C3, A3S5, C3S1]	100 VAC [A6, S1] 500 VAC [A3]	140 VAC
Max. switch. current contact	0.25 A [S1] 0.5 A [A3, C3, A6, A3S5, C3S1] 3 A [A9S1]	0.25 A [S1] 0.5 A [A3, A6]	1 A
Max. switch. power contact	5 VA [A3, C3, A3S5, C3S1] 60 VA [A9S1] 100 VA [S1, A6]	5 VA [S1] 10 VA [A3, A6]	10 VA
Max carry current			1.2 A

### General specifications

Operating distance	5 - 36 mm	8 - 27 mm	> 8 mm
Output connection	PVC cable 0.5 m for Ø 9.3 2 m for M10 and M12	PVC cable, 2 m	Twin lead cable, 0.5 m
Degree of protection	IP 67	IP 67	IP 67
Operating temperature	-25°C to +75°C	-25°C to +70°C	-20°C to +75°C
Housing material	Plastic [A3, C3, S1] Nickel plated brass [A6] Brass [A3S5, C3S1, A9S1]	Stainless steel [A3, S1] Nickel plated brass [A6]	Plastic

### References

Normally open	<b>FMA3</b> <b>FMA3S5</b> <b>FMA6</b> <b>FMA9S1</b>	<b>FMMA3</b> <b>FMMA6</b>	<b>FMMPA7L25</b> <b>FMMPA7L33</b> <b>FMMPA7L38</b>
Normally closed	<b>FMC3</b> <b>FMC3S1</b>		
Change - Over	<b>FMS1</b>	<b>FMMS1</b>	

# Proximity magnetic sensors, cylindrical



Types	FMP... series	FS... series	FSLP... series	FSM... series
Dimensions (mm)	M12 x 1 x 100	Ø 13.5 [A2, A8, C2, C8, S2] M10 x 1.25 [A2S3, S2S1] M12 x 1 [A2S4, S2S4] M16 x 1.5 [B2]	Ø 16	M12 x 1 [A2, A7, S2] M16 x 1 [S2S2AT]

## Electrical specifications

Max. switch. voltage contact	120 VAC / DC [C7] 175 VDC, 120 VAC [S1] 200 VDC, 140 VAC [A7] 230 VAC / DC [A9, C9, A9S1] 250 VAC / DC [B2]	230 VAC [S2, S2S1, S2S4] 250 VAC [A2, B2, C2, A2S3, A2S4] 1500 VAC [A8, C8]	100 VAC [A7] 250 VAC [B2]	24 VDC [A7] 230 VAC [S2, S2S2AT] 250 VAC [A2]
Max. switch. current contact	0.25 A [S1] 0.5 A [C7] 1 A [A7] 3 A [B2, A9, C9, A9S1]	1 A [S2, S2S4, S2S1] 3 A [A2, B2, C2, A8, C8, A2S3, A2S4]	0.4 A [A7] 3 A [B2]	0.5 A [S2S2AT] 1 A [S2] 3 A [A2] 50 mA [A7]
Max. switch. power contact	5 VA [S1] 10 VA [A7, C7] 60 VA [A9, C9, A9S1] 120 VA [B2]	60 VA [S2S1, S2S4, S2] 100 VA [A2, B2, C2, A2S3, A2S4] 120 VA [A8, C8]	10 VA [A7] 120 VA [B2]	30 VA [S2S2AT] 60 VA [S2] 100 VA [A2] (A7 negligible)





## General specifications

Operating distance	7 - 26 mm	3 - 32 mm	18 - 25 mm (front); >10 - >15 mm (side)	2 - 19 mm
Output connection	PVC cable, 2 m	PVC cable, 2 m 0.5 m for Ø 13.5	PVC cable, 2 m	Silicone cable, 2 m [A7] Silicone cable, 0.5 m [S2S2AT] PVC cable, 2 m [A2, S2]
Degree of protection	IP 67	IP 67	IP 67	IP 67
Operating temperature	-25°C to +75°C	-25°C to +75°C	-30°C to +80°C	-25°C to +75°C [A2, A7, S2] -20°C to +150°C [S2S2AT]
Housing material	Plastic	Plastic [A2, A8, C2, C8, S2, B2] Brass [A2S3 / S4, S2S1 / S4]	Plastic	Brass [S2S2, S2S2AT] Nickel plated brass [A2, A7, S2]

## References



Normally open	<b>FMPA7</b> [black] <b>FMPA9</b> [black] <b>FMPA9S1</b> [black]	<b>FSA2</b> <b>FSA8</b> <b>FSA2S32MT</b> <b>FSA2S42MT</b>	<b>FSLPA7</b>	<b>FSMA2</b> <b>FSMA7</b>
Normally closed	<b>FMPC7</b> [red] <b>FMPC9</b> [red]	<b>FSC2</b> <b>FSC8</b>		
Change - Over	<b>FMP51</b> [blue]	<b>FSS2</b> <b>FSS2S12MT</b> <b>FSS2S42MT</b>		<b>FSMS2</b> <b>FSMS2S2AT</b>
Bistable	<b>FMPB2</b> [grey]	<b>FSB22MT</b>	<b>FSLPB2</b>	

# Proximity magnetic sensors, slot



			Slot		
Types	ISY series		IM series		
					
Dimensions (mm)	10 x 45 x 37		7 x 28 x 18.5		
Electrical specifications					
Max. switch. voltage contact	100 VAC [S1] 500 VAC [C3]		100 VAC [S1] 500 VAC [C3]		
Max. switch. current contact	0.25 A [S1] 0.5 A [C3]		0.25 A [S1] 0.5 A [C3]		
Max. switch. power contact	5 VA [S1] 10 VA [C3]		5 VA [S1] 10 VA [C3]		
General specifications					
Output connection	PVC cable, 0.5 m		PVC cable, 0.5 m		
Degree of protection	IP 67		IP 67		
Operating temperature	-25°C to +75°C		-25°C to +75°C		
Housing materials	Plastic		Plastic		
References					
Normally closed	ISYC3		IMC3		
Change - Over	ISYS1		IMS1		
Types		Magnetic units CL series			
Shapes	Rectangular	Trapezoidal	Cylindrical		
					
General specifications					
Minimum separation:	Dimensions (mm)	References			
10	25 x 14 x 8	CL1			
20	44.5 x 12 x 9	CL2			
30	59 x 18 x 9	CL3			
50	76 x 25 x 18	CL4			
Not mandatory		Dimensions (mm)	References	Dimensions (mm)	References
		90 x 31 x 22.5	CL90	Ø 9.3 x 32	CL10
				Ø 13.5 x 65	CL11
				Ø 18 x 6	CL18
				Ø 23 x 9	CL23
				Ø 31 x 10	CL31
				Ø 20 x 10	CL20S1
				Ø 22.1 x 11.3	CL20S3



# Level magnetic sensors

Cylindrical			
Types	ILM series	ILMM series	ILMP series
			
Float Diameter (mm)	Ø 53	Ø 28	Ø 25
<b>Output functions</b>	Normally open, Normally closed [2, 8] Change-over [S2]	Normally open and normally closed [5, 590, 5ATS1] Normally open [5S1] Normally closed [5S2, 5S2AT]	Normally open, normally closed
<b>Electrical specifications</b>			
Max. switch. voltage contact	230 VAC [S2] - 250 VAC [2] 1500 VAC [8]	240 VAC, 220 VDC	240 VAC, 200 VDC
Max. switch. current contact	1 A [S2] 3 A [2, 8]	0.5 A	0.5 A
Max. switch. power contact	60 VA [S2] - 100 VA [2] 120 VA [8]	50 VA	50 VA
<b>General specifications</b>			
Output connection	Silicone cable, 0.5 m	XLPE cable, 0.3 m 1,1 m [ATS1]	PVC cable, 0.3 m
Min. liquid specific gravity	0.75 kg / dm <sup>3</sup>	0.75 kg / dm <sup>3</sup>	
Max. pressure	20 kg / cm <sup>2</sup>	10 kg / cm <sup>2</sup>	2 kg / cm <sup>2</sup>
Degree of protection	IP 67	IP 67	IP 67
Operating temperature	-25°C to +120°C [2, 8, S2]	-10°C to +120°C [5, 590] -10°C to +200°C [5ATS1, 5S2AT] -20°C to +120°C [5S1, 5S2]	-20°C to +80°C
Housing materials	AISI 316 Stainless steel	AISI 304 stainless steel [5, 590 5ATS1] AISI316 stainless steel [5S2AT, 5S1, 5S2]	Plastic
<b>References</b>			
Normally open / Normally closed	<b>ILM.2</b> <b>ILM8</b>	<b>ILMM5</b> <b>ILMM590</b> <b>ILMM5ATS1</b>	<b>ILMP5</b> <b>ILMP5P</b>
Change - Over	<b>ILMS2</b>		
Normally closed		<b>ILMM5S2AT</b> <b>ILMM5S2</b>	
Normally open		<b>ILMM5S1</b>	

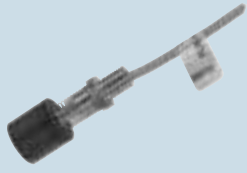

# Level magnetic sensors

		Cylindrical		
Types	ILMPU - ILU - ILMU series	ILSP series	FLM series - Flux Sensors	
				
Float Diameter (mm)	Ø 17.5 [ILMPU] Ø 31 [ILMU] Ø 45 [ILU]	Ø 44	Ø 20	
<b>Electrical specifications</b>				
Max. switch. voltage contact	230 VAC [ILUS2] 240 VAC, 200 VDC [ILMPU5, ILMU5] 250 VAC [ILU2] 1000 VAC [ILU8]	230 VAC [S2] 250 VAC [2] 1500 VAC [8]	100 VAC	
Max. switch. current contact	0.5 A [ILMP, ILM] 1 A [ILUS2] 3 A [ILU2, ILU8]	1 A [S2] 3 A [2, 8]	0.4 A	
Max. switch. power contact	50 VA [ILMP, ILM] 60 VA [ILUS2] 100 VA [ILU2] 120 VA [ILU8]	60 VA [S2] 100 VA [2] 120 VA [8]	10 VA	
<b>General specifications</b>				
Output connection	XLPE cable, 0.3 m [ILMPU5] PVC cable, 0.3 m [ILMU5] Silicone cable, 0.5 m [ILU2, ILU8, ILUS2]	Silicone cable, 0.5 m	HT105 PVC cable ended with 6.35 mm female faston	
Operating distance $D_{on}$			+5 mm	
Release distance $D_{off}$			$D_{on}$ - 2 mm	
Min. liquid specific gravity	0.70 kg / dm <sup>3</sup> [ILMPU, ILMU] 0.75 kg / dm <sup>3</sup> [ILU]	0.75 kg / dm <sup>3</sup>		
Max. pressure	2 kg / cm <sup>2</sup> [ILMPU, ILMU] 100 kg / cm <sup>2</sup> [ILU]	0.6 kg / cm <sup>2</sup>		
Degree of protection	IP 68	IP 67	IP 67	
Operating temperature	-20°C to +80°C [ILMPU, ILMU] -25°C to +100°C [ILU]	-25°C to +100°C	-30°C to +105°C	
Housing materials	Non toxic polypropylene or plastic	Plastic	Stainless steel	
<b>References</b>				
Normally open / Normally closed	<b>ILMPU5</b> <b>ILMU5</b>	<b>ILSP2</b> <b>ILSP8</b>		
Normally open	<b>ILU2</b> <b>ILU8</b>		<b>FLMAT51</b>	
Change - Over	<b>ILUS2</b>	<b>ILSPS2</b>		



## Ultrasonic sensors, 2 x digital outputs

Types	UA18CAD..TI	UA18CAD..MITI	UA30CAD35..TI	UA30CAD35..MITI
Connections	2 m cable	M12 connector	2 m cable	M12 connector
				
Dimensions (mm)	M18 x 85	M18 x 85	M30 x 90	M30 x 90
<b>References</b>				
Sensing distance (Sn)	50 - 400 mm	50 - 400 mm	250 - 3500 mm	250 - 3500 mm
Operating frequency	≤ 10 Hz	≤ 10 Hz	≤ 2 Hz	≤ 2 Hz
Blind zone	≤ 50 mm	≤ 50 mm	≤ 250 mm	≤ 250 mm
2 x NPN	<b>UA18CAD04NPPTI</b>	<b>UA18CAD04NPM1TI</b>	<b>UA30CAD35NPPTI</b>	<b>UA30CAD35NPM1TI</b>
2 x PNP	<b>UA18CAD04PPPTI</b>	<b>UA18CAD04PPM1TI</b>	<b>UA30CAD35PPPTI</b>	<b>UA30CAD35PPM1TI</b>
Sensing distance (Sn)	100 - 900 mm	100 - 900 mm		
Operating frequency	≤ 4 Hz	≤ 4 Hz		
Blind zone	≤ 100 mm	≤ 100 mm		
2 x NPN	<b>UA18CAD09NPPTI</b>	<b>UA18CAD09NPM1TI</b>		
2 x PNP	<b>UA18CAD09PPPTI</b>	<b>UA18CAD09PPM1TI</b>		
Sensing distance (Sn)	200 - 2200 mm	200 - 2200 mm		
Operating frequency	≤ 1 Hz	≤ 1 Hz		
Blind zone	≤ 200 mm	≤ 200 mm		
2 x NPN	<b>UA18CAD22NPPTI</b>	<b>UA18CAD22NPM1TI</b>		
2 x PNP		<b>UA18CAD22PPM1TI</b>		
<b>Specifications</b>				
Rated operating voltage	15 - 30 VDC	15 - 30 VDC	12 - 30 VDC	12 - 30 VDC
Voltage drop	≤ 2.2 VDC	≤ 2.2 VDC	≤ 2.2 VDC	≤ 2.2 VDC
Degree of protection	IP 67	IP 67	IP 67	IP 67
Protection Short-circuit (S) Reverse polarity (P) Transients (T)	SPT	SPT	SPT	SPT
Load current	< 500 mA	< 500 mA	< 300 mA	< 300 mA
Load current - UL	< 100 mA	< 100 mA	< 100 mA	< 100 mA
Housing material	PBT	PBT	PBT	PBT
Operating temperature	-20°C to +60°C	-20°C to +60°C	-20°C to +70°C	-20°C to +70°C
LED colour	Yellow	Yellow	Yellow, green	Yellow, green
Approvals/Marks	CE - cULus	CE - cULus	CE - cULus	CE - cULus





## Ultrasonic sensors, 2 x digital outputs

Types	UA30CAD60..TI	UA30CAD60..MITI
Connections	2 m cable	M12 connector
		
Dimensions (mm)	M30 (Ø40) x 90	M30 (Ø40) x 90
<b>References</b>		
Sensing distance (Sn)	350 - 6000 mm	350 - 6000 mm
Operating frequency	≤ 1 Hz	≤ 1 Hz
Blind zone	≤ 350 mm	≤ 350 mm
2 x NPN	<b>UA30CAD60NPTI</b>	<b>UA30CAD60NPM1TI</b>
2 x PNP	<b>UA30CAD60PPTI</b>	<b>UA30CAD60PPM1TI</b>
<b>Specifications</b>		
Rated operating voltage	12 - 30 VDC	12 - 30 VDC
Voltage drop	≤ 2.2 VDC	≤ 2.2 VDC
Degree of protection	IP 67	IP 67
Protection Short-circuit (S) Reverse polarity (P) Transients (T)	SPT	SPT
Load current	< 300 mA	< 300 mA
Load current - UL	< 100 mA	< 100 mA
Housing material	PBT	PBT
Operating temperature	-20°C to +70°C	-20°C to +70°C
LED colour	Yellow, green	Yellow, green
Approvals/Marks	CE - cULus	CE - cULus



## Ultrasonic sensors, 2 x digital outputs

Types	UA18EAD..TI	UA18EAD..MITI	UA30EAD35..TI	UA30EAD35..MITI
Connections	2 m cable	M12 connector	2 m cable	M12 connector
				
Dimensions (mm)	M18 x 85	M18 x 85	M30 x 90	M30 x 90
References				
Sensing distance (Sn)	50 - 400 mm	50 - 400 mm	350 - 3500 mm	350 - 3500 mm
Operating frequency	≤ 10 Hz	≤ 10 Hz	≤ 2 Hz	≤ 2 Hz
Blind zone	≤ 50 mm	≤ 50 mm	≤ 350 mm	≤ 350 mm
2 x NPN	<b>UA18EAD04NPTI</b>	<b>UA18EAD04NPM1TI</b>	<b>UA30EAD35NPTI</b>	<b>UA30EAD35NPM1TI</b>
2 x PNP	<b>UA18EAD04PPTI</b>	<b>UA18EAD04PPM1TI</b>	<b>UA30EAD35PPTI</b>	<b>UA30EAD35PPM1TI</b>
Sensing distance (Sn)	100 - 900 mm	100 - 900 mm		
Operating frequency	≤ 4 Hz	≤ 4 Hz		
Blind zone	≤ 100 mm	≤ 100 mm		
2 x NPN	<b>UA18EAD09NPTI</b>	<b>UA18EAD09NPM1TI</b>		
2 x PNP	<b>UA18EAD09PPTI</b>	<b>UA18EAD09PPM1TI</b>		
Sensing distance (Sn)	200 - 1500 mm	200 - 1500 mm		
Operating frequency	≤ 1 Hz	≤ 1 Hz		
Blind zone	≤ 200 mm	≤ 200 mm		
2 x NPN	<b>UA18EAD15NPTI</b>	<b>UA18EAD15NPM1TI</b>		
2 x PNP	<b>UA18EAD15PPTI</b>	<b>UA18EAD15PPM1TI</b>		
Specifications				
Rated operating voltage	15 - 30 VDC	15 - 30 VDC	12 - 30 VDC	12 - 30 VDC
Voltage drop	≤ 2.2 VDC	≤ 2.2 VDC	≤ 2.2 VDC	≤ 2.2 VDC
Degree of protection	IP 67	IP 67	IP 67	IP 67
Protection Short-circuit (S) Reverse polarity (P) Transients (T)	SPT	SPT	SPT	SPT
Load current	< 500 mA	< 500 mA	< 300 mA	< 300 mA
Load current - UL	< 100 mA	< 100 mA	< 100 mA	< 100 mA
Housing material	AISI 316L	AISI 316L	AISI 316L	AISI 316L
Operating temperature	-20°C to +60°C	-20°C to +60°C	-20°C to +70°C	-20°C to +70°C
LED colour	Yellow	Yellow	Yellow, green	Yellow, green
Approvals/Marks	CE - cULus	CE - cULus	CE - cULus	CE - cULus





## Ultrasonic sensors, analog and digital output

Types	UA18CAD..TI	UA18CAD..MITI	UA30CAD35..TI	UA30CAD35..MITI
Connections	2 m cable	M12 connector	2 m cable	M12 connector
				
Dimensions (mm)	M18 x 85	M18 x 85	M30 x 90	M30 x 90
References				
Sensing distance (Sn)	50 - 400 mm	50 - 400 mm	250 - 3500 mm	250 - 3500 mm
Operating frequency	≤ 10 Hz	≤ 10 Hz	≤ 2 Hz	≤ 2 Hz
Blind zone	≤ 50 mm	≤ 50 mm	≤ 250 mm	≤ 250 mm
NPN, 4-20 mA	<b>UA18CAD04NGTI</b>	<b>UA18CAD04NGM1TI</b>	<b>UA30CAD35NGTI</b>	<b>UA30CAD35NGM1TI</b>
PNP, 4-20 mA	<b>UA18CAD04PGTI</b>	<b>UA18CAD04PGM1TI</b>	<b>UA30CAD35PGTI</b>	<b>UA30CAD35PGM1TI</b>
NPN, 0-10 V	<b>UA18CAD04NKTI</b>	<b>UA18CAD04NKM1TI</b>	<b>UA30CAD35NKTI</b>	<b>UA30CAD35NKM1TI</b>
PNP, 0-10 V	<b>UA18CAD04PKTI</b>	<b>UA18CAD04PKM1TI</b>	<b>UA30CAD35PKTI</b>	<b>UA30CAD35PKM1TI</b>
Sensing distance (Sn)	100 - 900 mm	100 - 900 mm		
Operating frequency	≤ 4 Hz	≤ 4 Hz		
Blind zone	≤ 100 mm	≤ 100 mm		
NPN, 4-20 mA	<b>UA18CAD09NGTI</b>	<b>UA18CAD09NGM1TI</b>		
PNP, 4-20 mA	<b>UA18CAD09PGTI</b>	<b>UA18CAD09PGM1TI</b>		
NPN, 0-10 V	<b>UA18CAD09NKTI</b>	<b>UA18CAD09NKM1TI</b>		
PNP, 0-10 V	<b>UA18CAD09PKTI</b>	<b>UA18CAD09PKM1TI</b>		
Sensing distance (Sn)	200 - 2200 mm	200 - 2200 mm		
Operating frequency	≤ 1 Hz	≤ 1 Hz		
Blind zone	≤ 200 mm	≤ 200 mm		
NPN, 4-20 mA	<b>UA18CAD22NGTI</b>	<b>UA18CAD22NGM1TI</b>		
PNP, 4-20 mA	<b>UA18CAD22PGTI</b>	<b>UA18CAD22PGM1TI</b>		
NPN, 0-10 V	<b>UA18CAD22NKTI</b>	<b>UA18CAD22NKM1TI</b>		
PNP, 0-10 V	<b>UA18CAD22PKTI</b>	<b>UA18CAD22PKM1TI</b>		
Specifications				
Rated operating voltage NG or PG NK or PK	15 - 30 VDC 15 - 30 VDC	15 - 30 VDC 15 - 30 VDC	12 - 30 VDC 15 - 30 VDC	12 - 30 VDC 15 - 30 VDC
Voltage drop	≤ 2.2 VDC	≤ 2.2 VDC	≤ 2.2 VDC	≤ 2.2 VDC
Degree of protection	IP 67	IP 67	IP 67	IP 67
Protection Short-circuit (S) Reverse polarity (P) Transients (T)	Digital output: SPT Supply: PT Analogue output: P	Digital output: SPT Supply: PT Analogue output: P	Digital output: SPT Supply: PT Analogue output: P	Digital output: SPT Supply: PT Analogue output: P
Load current	< 500 mA	< 500 mA	< 100 mA	< 100 mA
Load current - UL	< 100 mA	< 100 mA	< 100 mA	< 100 mA
Housing material	PBT	PBT	PBT	PBT
Operating temperature	-20°C to +60°C	-20°C to +60°C	-20°C to +70°C	-20°C to +70°C
LED colour	Yellow	Yellow	Yellow, green	Yellow, green
Approvals/Marks	CE - cULus	CE - cULus	CE - cULus	CE - cULus

## Ultrasonic sensors, analog and digital output

Types	UA30CAD60..TI	UA30CAD60..MITI
Connections	2 m cable	M12 connector
		
Dimensions (mm)	M30 (Ø40) x 90	M30 (Ø40) x 90
<b>References</b>		
Sensing distance (Sn)	350 - 6000 mm	350 - 6000 mm
Operating frequency	≤ 1 Hz	≤ 1 Hz
Blind zone	≤ 350 mm	≤ 350 mm
NPN, 4-20 mA	<b>UA30CAD60NGTI</b>	<b>UA30CAD60NGMITI</b>
PNP, 4-20 mA	<b>UA30CAD60PGTI</b>	<b>UA30CAD60PGMITI</b>
NPN, 0-10 V	<b>UA30CAD60NKTI</b>	<b>UA30CAD60NKMITI</b>
PNP, 0-10 V	<b>UA30CAD60PKTI</b>	<b>UA30CAD60PKMITI</b>
<b>Specifications</b>		
Rated operating voltage NG or PG NK or PK	12 - 30 VDC 15 - 30 VDC	12 - 30 VDC 15 - 30 VDC
Voltage drop	≤ 2.2 VDC	≤ 2.2 VDC
Degree of protection	IP 67	IP 67
Protection Short-circuit (S) Reverse polarity (P) Transients (T)	Digital output: SPT Supply: PT Analogue output: P	Digital output: SPT Supply: PT Analogue output: P
Load current	< 100 mA	< 100 mA
Load current - UL	< 100 mA	< 100 mA
Housing material	PBT	PBT
Operating temperature	-20°C to +70°C	-20°C to +70°C
LED colour	Yellow, green	Yellow, green
Approvals/Marks	CE - cULus	CE - cULus

## Ultrasonic sensors, analog and digital output

Types	UA18EAD..TI	UA18EAD..MITI	UA30EAD35..TI	UA30EAD35..MITI
Connections	2 m cable	M12 connector	2 m cable	M12 connector
				
Dimensions (mm)	M18 x 85	M18 x 85	M30 x 93	M30 x 100
References				
Sensing distance (Sn)	50 - 400 mm	50 - 400 mm	350 - 3500 mm	350 - 3500 mm
Operating frequency	≤ 10 Hz	≤ 10 Hz	≤ 2 Hz	≤ 2 Hz
Blind zone	≤ 50 mm	≤ 50 mm	≤ 350 mm	≤ 350 mm
NPN, 4-20 mA	<b>UA18EAD04NGTI</b>	<b>UA18EAD04NGM1TI</b>	<b>UA30EAD35NGTI</b>	<b>UA30EAD35NGM1TI</b>
PNP, 4-20 mA	<b>UA18EAD04PGTI</b>	<b>UA18EAD04PGM1TI</b>	<b>UA30EAD35PGTI</b>	<b>UA30EAD35PGM1TI</b>
NPN, 0-10 V	<b>UA18EAD04NKTI</b>	<b>UA18EAD04NKM1TI</b>	<b>UA30EAD35NKTI</b>	<b>UA30EAD35NKM1TI</b>
PNP, 0-10 V	<b>UA18EAD04PKTI</b>	<b>UA18EAD04PKM1TI</b>	<b>UA30EAD35PKTI</b>	<b>UA30EAD35PKM1TI</b>
Sensing distance (Sn)	100 - 900 mm	100 - 900 mm		
Operating frequency	≤ 4 Hz	≤ 4 Hz		
Blind zone	≤ 100 mm	≤ 100 mm		
NPN, 4-20 mA	<b>UA18EAD09NGTI</b>	<b>UA18EAD09NGM1TI</b>		
PNP, 4-20 mA	<b>UA18EAD09PGTI</b>	<b>UA18EAD09PGM1TI</b>		
NPN, 0-10 V	<b>UA18EAD09NKTI</b>	<b>UA18EAD09NKM1TI</b>		
PNP, 0-10 V	<b>UA18EAD09PKTI</b>	<b>UA18EAD09PKM1TI</b>		
Sensing distance (Sn)	200 - 1500 mm	200 - 1500 mm		
Operating frequency	≤ 1 Hz	≤ 1 Hz		
Blind zone	≤ 200 mm	≤ 200 mm		
NPN, 4-20 mA	<b>UA18EAD15NGTI</b>	<b>UA18EAD15NGM1TI</b>		
PNP, 4-20 mA	<b>UA18EAD15PGTI</b>	<b>UA18EAD15PGM1TI</b>		
NPN, 0-10 V	<b>UA18EAD15NKTI</b>	<b>UA18EAD15NKM1TI</b>		
PNP, 0-10 V	<b>UA18EAD15PKTI</b>	<b>UA18EAD15PKM1TI</b>		
Specifications				
Rated operating voltage NG or PG NK or PK	15 - 30 VDC 15 - 30 VDC	15 - 30 VDC 15 - 30 VDC	12 - 30 VDC 15 - 30 VDC	12 - 30 VDC 15 - 30 VDC
Voltage drop	≤ 2.2 VDC	≤ 2.2 VDC	≤ 2.2 VDC	≤ 2.2 VDC
Degree of protection	IP 67	IP 67	IP 67	IP 67
Protection Short-circuit (S) Reverse polarity (P) Transients (T)	Digital output: SPT Supply: PT Analogue output: P	Digital output: SPT Supply: PT Analogue output: P	Digital output: SPT Supply: PT Analogue output: P	Digital output: SPT Supply: PT Analogue output: P
Load current	< 100 mA	< 100 mA	< 100 mA	< 100 mA
Load current - UL	< 100 mA	< 100 mA	< 100 mA	< 100 mA
Housing material	AISI 316L	AISI 316L	AISI 316L	AISI 316L
Operating temperature	-20°C to +60°C	-20°C to +60°C	-20°C to +70°C	-20°C to +70°C
LED colour	Yellow	Yellow	Yellow, green	Yellow, green
Approvals/Marks	CE - cULus	CE - cULus	CE - cULus	CE - cULus



# Ultrasonic sensors, DC, analogue, remote teach

	Programmable RS232	Integrated amplifier
<b>Types</b>	<b>UA30CLD..M7</b>	<b>UA12BLD..M1TR</b>
<b>Connections</b>	<b>M16 connector</b>	<b>M12 connector</b>
		

Dimensions (mm)	M30 x 136	M12 x 79
-----------------	-----------	----------

## References diffuse reflective

Operating frequency	5 - 30 Hz Programmable	20 Hz
Sensing distance (Sn)	150 - 1500 mm adj.	25 - 200 mm adj.
0-10 VDC	<b>UA30CLD15FKM7</b>	
4-20 mA	<b>UA30CLD15FGM7</b>	
NPN-NO/NC		<b>UA12BLD02NPM1TR</b>
PNP-NO/NC		<b>UA12BLD02PPM1TR</b>
Sensing distance (Sn)	250 - 2000 mm adj.	
0-10 VDC	<b>UA30CLD20FKM7</b>	
4-20 mA	<b>UA30CLD20FGM7</b>	
Sensing distance (Sn)	350 - 3500 mm adj.	
0-10 VDC	<b>UA30CLD35FKM7</b>	
4-20 mA	<b>UA30CLD35FGM7</b>	

## Specifications

Rated operating voltage	19 - 30 VDC	10 - 30 VDC
Voltage drop	≤ 2.5 VDC	≤ 4.5 V
Degree of protection	IP 67	IP 65
Protection Short-circuit (S) Reverse polarity (P) Transients (T)	SPT	SPT
Load current	< 100 mA Analogue see type	< 100 mA
Housing material	PBTB	Stainless Steel
Operating temperature	-15°C to +70°C	-20°C to +70°C
LED colour	Yellow + Green	
Remarks	Hold/sync. input RS232	
Approvals/Marks	CE - UL - cUL	CE



	Adapters		
Types	AUA - RT	UCC	UCP1 and UCP2
Connections	M12 connector	Terminal block	Terminal block

			
Dimensions (mm)	17 x 56	38.5 x 80.5	38.5 x 80.5

## Specifications



	Programming adapter for remote teach sensors ending with "RT"	RS232 to RS485 adapter	Programming adapter RS232
--	---	------------------------	---------------------------

# Motion sensors

	Standard range RAD series		Long range IRS series
Types	RAD 01	RAD 02	IRS 01
Connections	cable	cable	cable
			
Dimensions (mm)	118 x 80 x 53	118 x 80 x 53	137 x 188 x 91.5
Features	K-Band radar sensor compatible with all swinging and sliding automatic doors. 3-D adjustable position of the sensor offers precise orientation of the activation pattern. Microprocessor technology filters out possible weather condition interferences. IR remote controller can be added for easy adjustment.		K-Band unidirectional long range motion sensor for trouble-free opening of all types of industrial automatic doors. To detect either people or vehicles, whether they are moving towards or away from the sensor. Microprocessor technology filters out possible weather condition interferences. IR remote controller can be added for easy adjustment.
<b>Input specifications</b>			
Detection Angle	V: 0 to 90° in 15° increments L: ±30° in 7.5° increments	V: 0 to 90° in 15° increments L: ±30° in 7.5° increments	V: ±45° in 15° increments L: ±45° in 15° increments
Detecting Area	mounting height 2.2 m 4 m (W) x 2 m (D)	mounting height 2.2 m 4 m (W) x 2 m (D)	mounting height 2.5 m~7 m 2.5 m (W) x 8 m (D)
Wide sensing field	2 m (W) x 2.5 m (D)	2 m (W) x 2.5 m (D)	2.5 m (W) x 10 m (D)
Narrow sensing field			
Detection Mode	Bidirectional	Uni & Bidirectional	Uni & Bidirectional
Motion Detecting Speed	0.05~1 m/s	0.05~1 m/s	0.05~3.0 m/s along sensor axis
<b>Adjustments</b>			
Sensitivity	10 levels (1 to 10)	10 levels (1 to 10)	5 levels (1 to 5)
Hold Time	From 0.5 to 9 s in 10 steps	From 0.5 to 9 s in 10 steps	From 0.5 to 9 s in 10 steps
Immunity Detection	"Quasi-presence", normal, increased immunity	"Quasi-presence", normal, increased immunity	"Quasi-presence", normal, increased immunity, LTS
Direction Recognition	- Bidirectional detection	- Unidirectional approaching - Unidirectional departig - Uni & Bidirectional detection	- Unidirectional approaching - Unidirectional departig - Uni & Bidirectional detection
Operating Modes (or relays assignment)			- Differentiation between people and vehicles - People suppression - Vehicles suppression - People or vehicles with direction segregation
LTS			Lateral traffics suppression "toggle" type function
<b>Output specifications</b>			
Output Relay SPDT			
Max. contact voltage	24 VDC / 120 VAC	24 VDC / 120 VAC	24 VDC / 120 VAC
Max. contact current	1 A (resistive)	1 A (resistive)	1 A (resistive)
Max. switching power	30 W (DC) / 120 VA (AC)	30 W (DC) / 120 VA (AC)	30 W (DC) / 120 VA (AC)
Hold time	0.5~9 s (adjustable)	0.5~9 s (adjustable)	0.5~6 s (adjustable)
<b>Electrical specifications</b>			
Frequency emitted	24.125 GHz	24.125 GHz	24.125 GHz
Rated supply voltage	12~24 VAC ±10% 12~24 VDC +30% / -10%	12~24 VAC ±10% 12~24 VDC +30% / -10%	12~24 VAC ±10% 12~24 VDC +30% / -10%
Mains frequency	50 to 60 Hz	50 to 60 Hz	50 to 60 Hz
Power consumption	< 0.5 W	< 0.5 W	< 1.2 W
Approvals	CE - FCC - cURus	CE - FCC - cURus	CE - FCC - cURus
<b>References</b>			
Sensor	<b>RAD 01</b>	<b>RAD 02</b>	<b>IRS 01</b>
Remote controller	<b>RAD 00 RC</b>	<b>RAD 00 RC</b>	<b>IRS 00 RC</b>



# Motion and presence sensors

## Combined motion and presence detectors for pedestrian doors

Types	GUARDIAN 1	GUARDIAN 2
Connections	Terminal block	Terminal block
		
Dimensions (mm)	210 x 77 x 58	210 x 77 x 58
Technology	Digital video camera technology 640 x 480	Digital video camera technology 640 x 480
Door types	Streight sliding doors	Curved and Streight sliding doors
Features	The Guardian sensor is a unique motion and presence detector that provides maximum safety and protection in pedestrian sliding door installations. Equipped with the latest digital video camera technology, Guardian watches over the entrance and exit area safeguarding people within, while at the same time controlling the doors. Guardian is able to ignore cross traffic, and it has a brilliant capability of self-adjusting to changes in the environment and weather conditions	
<b>Input specifications</b>		
Mounting height	180 cm to 300 cm	180 cm to 300 cm
Motion zone sensing area	Hight 180 cm = 246 x 204 cm Hight 220 cm = 300 x 249 cm Hight 300 cm = 410 x 340 cm	Hight 180 cm = 246 x 204 cm Hight 220 cm = 300 x 249 cm Hight 300 cm = 410 x 340 cm
Presence zone sensing area	Hight 180 cm = 42 cm x door width Hight 220 cm = 51 cm x door width Hight 300 cm = 70 cm x door width	Hight 180 cm = 42 cm x door width Hight 220 cm = 51 cm x door width Hight 300 cm = 70 cm x door width
Maximum door radius vs. Mounting height		Hight 180 cm = Radius 130 cm Hight 220 cm = Radius 170 cm Hight 300 cm = Radius 200 cm
Sensitivity	Adjusting in 7 steps	Adjusting in 7 steps
Presence time	7 step rotary switch: (10, 30 sec.) 1 min, 5 min (Not accordance to DIN18650)	7 step rotary switch: (10, 30 sec.) 1 min, 5 min (Not accordance to DIN18650)
Ambient Light	10 lux - 50.000 lux	10 lux - 50.000 lux
<b>Output specifications</b>		
Output function	Safety and Motion Zone: Relay - SPST Common relay data: 1 A DC 30 VDC 600.000 cycles @ 0.5 A, 50 VAC/30 VDC	Safety and Motion Zone: Relay - SPST Common relay data: 1 A DC 30 VDC 600.000 cycles @ 0.5 A, 50 VAC/30 VDC
<b>General specifications</b>		
Rated operating voltage	12 - 24 VAC	12 - 24 VAC
No load supply current	Max. 230 mA	Max. 230 mA
Test input. Active high	ON > 9 VAC/VDC OFF < 6 VAC/VDC	ON > 9 VAC/VDC OFF < 6 VAC/VDC
Test input. Active low	ON < 6 VAC/VDC OFF > 9 VAC/VDC	ON < 6 VAC/VDC OFF > 9 VAC/VDC
Type of ESPE	Type 2	Type 2
Degree of protection	IP 64	IP 64
TÜV	In acc. with machinery directive 2006/42/EC, annex I DIN 18650-1 § 5.7.4, edition 2005 (prEN16005), EN13241-1, EN 12978	In acc. with machinery directive 2006/42/EC, annex I DIN 18650-1 § 5.7.4, edition 2005 (prEN16005), EN13241-1, EN 12978
UL-approved	cURus: UL325, CSA-C22.2 No. 247	cURus: UL325, CSA-C22.2 No. 247
Marking	CE	CE
<b>References</b>		
Marking	GUARDIAN 1	GUARDIAN 2



# Environmental sensors

## Environmental sensors - CGES series



Types	CGESHTD..N CGESHTPD...N	CGESHTW CGESHTPW	CGESAIRVEL
			
Dimensions (mm)	80 x 80 x 37.2 (probe 200 mm)	85 x 100 x 26	80 x 80 x 37.2 (cable lenght 1m)
Function	Humidity and Temperature	Humidity and Temperature	Air Velocity measurement
Mounting	Duct mounting	Wall mounting	Duct mounting
<b>Input specifications</b>			
Relative humidity Working range Accuracy @ 20°C	10 to 95% ±2.5% RH	0 to 95% ±2% (40 to 60%RH) ±3% (10 to 90%RH)	
Temperature Sensor Accuracy @ 20°C	Pt1000 DIN A ±0.3°C	Pt1000 DIN A / Pt100 DIN A Vout: ±0.25°C / Aout: ±0.4°C	
Air Velocity Working range			0 to 10 m/s (0 to 2000 ft/min) 0 to 15 m/s (0 to 3000 ft/min) 0 to 20 m/s (0 to 4000 ft/min)
Accuracy @ 20°C			±0.2 m/s +3% of m.v.
<b>Electrical specifications</b>			
Output	0-10 V or 4-20 mA (2 wires)	0-10 V or 4-20 mA (2 wires)	0-10 V or 4-20 mA
Supply Voltage	24 VAC ±20% / 15-35 VDC	24 VAC ±20% / 15-35 VDC	24 VAC/DC ±20%
Consumption DC supply AC supply	typical 5 mA typical 13 mAeff	typical 4 mA typical 15 mAeff	max. 150 mA max. 90 mA
<b>General specifications</b>			
Cable gland	M16 x 1.5 cable Ø4.5 - 10 mm		M16 x 1.5 cable Ø4.5 - 10 mm
Electrical connections	Screw terminals max. 1.5 mm <sup>2</sup> (AWG 16)	Screw terminals max. 1.5 mm <sup>2</sup> (AWG 16)	Screw terminals max. 1.5 mm <sup>2</sup> (AWG 16)
Working temperature range	-15°C to 60°C	-5°C to 55°C	-10°C to 50°C
Storage temperature range	-25°C to 60°C	-25°C to 60°C	-30°C to 60°C
Degree of protection	IP 65; Nema 4	IP 20	IP 65; Nema 4
Conformity	EN 61000-6-1, EN 61000-6-3, EN 61326-1+A1+A2	EN 50081-1 FCC Part15 ClassB EN 50082-1 ICES-003 ClassB	EN 50081-1, EN 50082-1, EN 50082-2
Approvals/Marks	CE - RoHS	CE - RoHS	CE - RoHS
<b>References</b>			
For ordering key details, please refer to <a href="http://www.productselection.net">www.productselection.net</a>			

# Environmental sensors

## Environmental sensors - CGES series

Types	CGESCO2W - CGESCO2TW - CGESCO2THW	CGESCO2D...N
		
Dimensions (mm)	85 x 100 x 26	80.6 x 101 x 46 (probe 200 mm)
Function	CO <sub>2</sub> , Relative Humidity and Temperature	CO <sub>2</sub>
Mounting	Wall mounting	Duct mounting
<b>Input specifications</b>		
Relative humidity Working range Accuracy @ 20°C	10 to 90% ±3% (30 to 70% RH) ±5% (10 to 90% RH)	
Temperature Sensor Accuracy @ 20°C	Pt1000 DIN A Vout: ±0.3°C / Aout: ±0.7°C	
CO <sub>2</sub> Working range Accuracy @ 20°C 2000 ppm 5000 ppm	0 to 2000 ppm / 0 to 5000 ppm  < ± 50 ppm +2% of m.v. < ± 50 ppm +3% of m.v.	0 to 2000 ppm / 0 to 5000 ppm  < ± 50 ppm +2% of m.v. < ± 50 ppm +3% of m.v.
<b>Electrical specifications</b>		
Output	0-10 V or 4-20 mA or switching	0-10 V or 4-20 mA
Supply Voltage	24 VAC ±20% / 15-35 VDC	24 VAC ±20% / 15-35 VDC
Consumption DC supply AC supply	<3 W <3 W	<3 W <3 W
<b>General specifications</b>		
Cable gland		M16 x 1.5 cable
Electrical connections	Screw terminals max. 1.5 mm <sup>2</sup> (AWG 16)	Screw terminals max. 2.5 mm <sup>2</sup> (AWG 14)
Working temperature range	-5°C to 55°C	0°C to 50°C
Storage temperature range	-20°C to 60°C	-20°C to 60°C
Degree of protection	IP 20	IP 65; Nema 4
Conformity	EN 61000-6-3, EN61326-1+A1+A2:05.2002 EN 61000-6-1	EN 61000-6-3 ÖVE EN61326-1+A1+A2:05.2002 EN 61000-6-1, FCC Part 15 ICES-003 ClassB
Approvals/Marks	CE - RoHS	CE - RoHS
<b>References</b>		
For ordering key details, please refer to <a href="http://www.productselection.net">www.productselection.net</a>		

## Environmental sensors

	Wind vane	Cup anemometer
<b>Types</b>	<b>DWS-D-D...</b>	<b>DWS-V-D...</b>
<b>Connections</b>	<b>2 m cable</b>	<b>2 m cable</b>
		
Dimensions (mm)	207 x 174	183 x 145
Use	Wind direction	Wind speed
<b>References wind vane</b>		
Wind indication	0° and 90° intervals <b>DWS-D-DAC13</b>	
Wind indication	±7° and left/right <b>DWS-D-DDC13</b>	
<b>References cup anemometer</b>		
Operating temperature		-20°C to 60°C
Heating		Yes <b>DWS-V-DAC13</b>
Operating temperature		0°C to 60°C
Heating		No <b>DWS-V-DBC05</b>
<b>General specifications</b>		
Rated operating voltage	12 - 24 VDC	12 - 24 VDC
Voltage drop	Typ. 4.9 VDC	Typ. 4.9 VDC
Degree of protection	IP 54	IP 54
Output frequency		10 Hz pr. m/s
Housing material	Body: Black PVC Rotor: Stainless steel	Body: Black PVC Rotor: Stainless steel
Approvals/Marks	CE	CE

# Environmental sensors

	Solar irradiance sensor		Pyranometer
Types	PVS-1V	PVS-1A	PVS-2A
Connections			

Dimensions (mm)	57 x 48 x 15 (not including clamp)	62 x 48 x 15 (not including clamp)	162 x 215 x 40
Description	Solar irradiance sensor based on photovoltaic technology built with a solid aluminium case and anti-UV encapsulating resin	Solar irradiance sensor based on photovoltaic technology built with a solid aluminium case and anti-UV encapsulating resin	Global solar radiation sensor based on a thermopile transducer compliant with WMO (World Meteorological Organization) standards for environmental monitoring, provided with worldwide valid calibration certificate

## Environmental specification

Operating temperature	-10°C to 80°C	-10°C to 80°C	-40°C to 80°C
Degree of protection	IP 67	IP 67	IP 67

## General specification











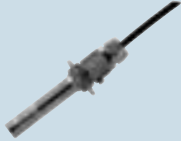

Technology	Crystalline calibrated cell	Crystalline calibrated cell	2nd Class Thermopile Pyranometer according to ISO9060
Output	80 mV @ 1000 W/m <sup>2</sup> STC	4-20 mA	4-20 mA
Calibration	According to IEC 60904-2 and 60904-4 (calibration certificate as option)	According to IEC 60904-2 and 60904-4 (calibration certificate as option)	According to ISO9847 (calibration certificate included)
Solar irradiance range	0-1250 W/m 20-1250 W/m <sup>2</sup>	0-1250 W/m 20-1250 W/m <sup>2</sup>	0-2000 W/m 20-2000 W/m <sup>2</sup>
Connector	3 PIN Phoenix M8 IP67 connector (male and female included)	3 PIN Phoenix M8 IP67 connector (male and female included)	7 pin IP68 connector (male, female and 10 meters cable included)
Housing material	Aluminium	Aluminium	Aluminium
Power Supply	Self-powered	Powered by VMU-P module through the 4-20 mA current loop	10-28 VDC, power consumption < 0.1 W
Approvals/Marks	CE	CE	CE

## References

For ordering key details, please refer to [www.productselection.net](http://www.productselection.net)

# Intrinsic safety

## Explosion proof sensors

Types	Cylindrical series FSQ	Rectangular series MQ	Level series ILM
			
Exter. Dimensions (mm) Float Dimensions (mm)	Ø16 x 110	37 x 16 x 8.3	Spherical Ø 53 [S], Cylindrical Ø 45x55 [C]
Category	2G, 2D	2G, 2D [MQx1EX] 1G, 1D [MQA0EX]	2G, 2D [ILMx2] 1G, 1D [ILMx0]
EX Identification	 II2GExmbIICT5Gb  II2DExmbIICT100°CDbIP67	 II2GExmbIICT5Gb [MQx1EX]  II2DExmbIICT100°CDbIP67 [MQx1EX]  II1GExialICT6Gα [MQA0EX]  II1DExialICT100°CdαIP67 [MQA0EX]	 II2GExmbIICT5Gb [ILMx2]  II2DExmbIICT100°CDbIP67 [ILMx2]  II1GExialICT6Gα [ILMx0]  II1DExialICT100°CdαIP67 [ILMx0]

## General specifications

Max. switch. voltage contact	250 VAC	230 VAC/DC [MQA1EX, MQC1EX] 30 VAC/DC [MQA0EX] 150 VAC/DC [MQS1EX]	250 VAC/DC [ILMA2] 230 VAC/DC [ILMS2] 30 VAC/DC [ILMx0]
Max. switch. current contact	3A	0.25 to 0.75 A [MQx1EX] 120 mA [MQA0EX]	3 A [ILMA2]; 1A [ILMS2] 120 mA [ILMx0]
Max. switch. power contact	100 VA	5 to 10 VA [MQx1EX] - [MQA0EX]	100 VA [ILMA2] 60 VA [ILMS2]
Operating distance	8 - 30 mm	10 - 35 mm	-
Degree of protection	IP 67 IP66 (FSQA2HFEX)	IP 67	IP 67
Temperature Class	T5	T5 [MQx1EX] T6 [MQA0EX]	T5 [ILMx2] T6 [ILMx0]
Body material	Stainless steel AISI 303	Self-exting. PP + 30% glass fiber	Stainless steel AISI 316
Approvals / mark	CE - TÜV Sud	CE - TÜV Sud	CE - TÜV Sud

## References

Normally open	<b>FSQA2B01SLEX</b> <b>FSQA2HFEX</b>	<b>MQA1EX</b> <b>MQA0EX</b>	<b>ILMA2SSLEX</b> <b>ILMA2CSLEX</b> <b>ILMA0SSLEX</b> <b>ILMA0CSLEX</b>
Normally closed		<b>MQC1EX</b>	
Change - Over		<b>MQS1EX</b>	<b>ILMS2SEX</b> <b>ILMS2CEX</b> <b>ILMS0SEX</b> <b>ILMS0CEX</b>



# Safety light curtains

	Safety light curtains, safety category 2 hand resolution	Safety light curtains, safety category 2 presence resolution
Types	SC2...	SC2...
 		

## General specifications

Power supply	24 VDC ±20%	24 VDC ±20%
OSSD outputs	2 PNP	2 PNP
Output connections	M12 4-pole connector for TX M12 5-pole connector for RXM12 4-pole connector for TX M12 5-pole connector for RX	M12 4-pole connector for TX M12 5-pole connector for RXM12 4-pole connector for TX M12 5-pole connector for RX
Safety category	Type 2	Type 2
Auxiliary functions	Reset / Test ; Automatic Restart	Reset / Test ; Automatic Restart
Housing material	Painted aluminium (yellow RAL 1003)	Painted aluminium (yellow RAL 1003)
Ambient light rejection	IEC 61496-2	IEC 61496-2
Degree of protection	IP 65 (EN 60529)	IP 65 (EN 60529)
Operating temperature	0°C to +55°C	0°C to +55°C
Approvals/Marks	CE - TÜV - cULus listed	CE - TÜV - cULus listed

## References

Resolution	Range	Protected height (mm)	No. of beams	Response time (ms)	REFERENCES	Protected height (mm)	No. of beams	Response time (ms)	REFERENCES
Hand 30 mm	0.2-19 m	150	8	8	<b>SC2AR30150D19</b>				
		300	16	9	<b>SC2AR30300D19</b>				
		450	24	11	<b>SC2AR30450D19</b>				
		600	32	12	<b>SC2AR30600D19</b>				
		750	40	14	<b>SC2AR30750D19</b>				
		900	48	15	<b>SC2AR30900D19</b>				
		1050	56	17	<b>SC2AR301050D19</b>				
		1200	64	18	<b>SC2AR301200D19</b>				
		1350	72	20	<b>SC2AR301350D19</b>				
		1500	80	21	<b>SC2AR301500D19</b>				
Presence 90 mm	0.2-19 m					300	5	9	<b>SC2AR90300D19</b>
						450	7	10	<b>SC2AR90450D19</b>
						600	9	11	<b>SC2AR90600D19</b>
						750	11	12	<b>SC2AR90750D19</b>
						900	13	13	<b>SC2AR90900D19</b>
						1050	15	14	<b>SC2AR901050D19</b>
						1200	17	15	<b>SC2AR901200D19</b>
						1350	19	16	<b>SC2AR901350D19</b>
						1500	21	17	<b>SC2AR901500D19</b>

# Safety light curtains

Safety light curtains, safety category 4  
finger resolution

Safety light curtains, safety category 4  
hand resolution

Types

SC4...

SC4...



## General specifications

Power supply	24 VDC ±20%	24 VDC ±20%
OSSD outputs	2 PNP	2 PNP
Output connections	M12 4-pole connector for TX M12 8-pole connector for RXM12 4-pole connector for TX M12 8-pole connector for RX	M12 4-pole connector for TX M12 8-pole connector for RXM12 4-pole connector for TX M12 8-pole connector for RX
Safety category	Type 4	Type 4
Auxiliary functions	Reset / Test ; Selectable Manual/Auto. Restart ; Selectable EDM	Reset / Test ; Selectable Manual/Auto. Restart ; Selectable EDM
Housing material	Painted aluminium (yellow RAL 1003)	Painted aluminium (yellow RAL 1003)
Ambient light rejection	IEC 61496-2	IEC 61496-2
Degree of protection	IP 65 (EN 60529)	IP 65 (EN 60529)
Operating temperature	0°C to +55°C	0°C to +55°C
Approvals/Marks	CE - TÜV - cULus listed	CE - TÜV - cULus listed

## References

Resolution	Range	Protected height (mm)	No. of beams	Response time (ms)	REFERENCES	Protected height (mm)	No. of beams	Response time (ms)	REFERENCES
Finger 14 mm	0.2 - 6 m	150	16	11	<b>SC4ED14150D6</b>				
		300	32	15	<b>SC4ED14300D6</b>				
		450	48	18	<b>SC4ED14450D6</b>				
		600	64	22	<b>SC4ED14600D6</b>				
		750	80	25	<b>SC4ED14750D6</b>				
		900	96	29	<b>SC4ED14900D6</b>				
		1050	112	33	<b>SC4ED141050D6</b>				
		1200	128	36	<b>SC4ED141200D6</b>				
Hand 30 mm	0.2 - 19 m					150	8	9	<b>SC4ED30150D19</b>
						300	16	11	<b>SC4ED30300D19</b>
						450	24	13	<b>SC4ED30450D19</b>
						600	32	14	<b>SC4ED30600D19</b>
						750	40	16	<b>SC4ED30750D19</b>
						900	48	18	<b>SC4ED30900D19</b>
						1050	56	19	<b>SC4ED301050D19</b>
						1200	64	21	<b>SC4ED301200D19</b>
						1350	72	23	<b>SC4ED301350D19</b>
				1500	80	25	<b>SC4ED301500D19</b>		
				1650	88	26	<b>SC4ED301650D19</b>		

# Safety magnetic sensors

## Safety magnetic sensors

### Types

SMS...



### Electrical specifications

Max. switch. voltage	100 VAC
Max. switch. power	5 VA
Max. switch. current	0.25 A

### General specifications

External dimensions (mm)	88 x 25 x 13; M18x1 SMSA2; M30x1.5 SMSA3P
Suitable magnetic unit	CLS; CLSA2 (SMSA2P); CLSA2M (SMSA2M); CLSA3 (SMSA3P)
Output connection	Cable (PVC, AWG 22 to 26, L=2 m.); pig tail with M12 connector, L=0.3 m
Degree of protection	IP 67
Operating temperature	-25°C to +70°C
Housing material	Plastic; PBT + 30 % glass (SMSA2P and SMSA3P); Stainless Steel (SMSA2M)
Approvals / Marks	CE - (UL version is available for some items with different codification)

### References

	Housing type / Material	Safety Aux. Outputs	Aux. Outputs	REFERENCES
	Rectangular / Plastic	1NO		SMS10
	Rectangular / Plastic	1NO	1NC	SMS10NC
0.3 m cable with M12 conn.	Rectangular / Plastic	1NO	1NC	SMS10NCCM1
	Rectangular / Plastic	1NO+1NC		SMS01
	Rectangular / Plastic	1NO+1NC		SMS02
LED on NC contact	Rectangular / Plastic	1NO+1NC		SMS02LD
Resistor on NO contact	Rectangular / Plastic	1NO+1NC		SMS02S1
	Rectangular / Plastic	2NO		SMS03
0.3 m cable with M12 conn.	Rectangular / Plastic	2NO		SMS03+CM1A4 /03MT
	Rectangular / Plastic	2NO	1NC	SMS03NC
0.3 m cable with M12 conn.	Rectangular / Plastic	2NO	1NC	SMS03NCS1
	Cylindrical / Plastic	1NO+1NC		SMSA2P02
LED on NC contact	Cylindrical / Plastic	1NO+1NC		SMSA2P02LD
	Cylindrical / Plastic	2NO		SMSA2P03
	Cylindrical / Plastic	1NO		SMSA2P10
	Cylindrical / Plastic	2NO		SMSA2P30
	Cylindrical / Plastic	1NO+1NC		SMSA3P02
	Cylindrical / Plastic	2NO		SMSA3P03
	Cylindrical / Plastic	2NO		SMSA3P30
	Cylindrical / Stainless steel	1NO+1NC		SMSA2M02
	Cylindrical / Stainless steel	1NO		SMSA2M10

### Types

CLS...

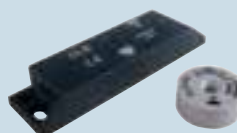

### General specifications

Degree of protection	IP 67
Operating temperature	-25°C to +70°C
Housing material	Plastic; Stainless Steel (CLSA2M)
Approvals / Marks	CE - (UL version is available for some items with different codification)

### References

	External dimensions (mm)	Shape	REFERENCES
	88 x 25 x 13	Rectangular	CLS
	Ø25.1 x 9.3	Cylindrical	CLSA2; CLSA2M
	Ø30 x 16	Cylindrical	CLSA3

# Connectors and brackets

## General Accessories, sensors



Dimensions (mm)	Straight M8 connector	Angled M8 connector	Straight M8 connector	Angled M8 connector
Used for	3-wire DC Sensors	3-wire DC Sensors	4-wire DC Sensors	4-wire DC Sensors
2 m cable	<b>CONM53NF-S2</b>	<b>CONM53NF-A2</b>	<b>CONM54NF-S2</b>	<b>CONM54NF-A2</b>
5 m cable	<b>CONM53NF-S5</b>	<b>CONM53NF-A5</b>	<b>CONM54NF-S5</b>	<b>CONM54NF-A5</b>
10 m cable			<b>CONM54NF-S10</b>	<b>CONM54NF-A10</b>
Degree of protection	IP 67	IP 67	IP 67	IP 67



Dimensions (mm)	Straight M12 connector	Angled M12 connector	Straight M12 connector	Angled M12 connector
Used for	3- or 4-wire DC	3- or 4-wire DC	3-, 4- or 5-wire DC	3-, 4- or 5-wire DC
2 m cable, 3-pin	<b>CONG10-S2</b>	<b>CONG10-A2</b>	<b>CONM13NF-S2</b>	<b>CONM13NF-A2</b>
5 m cable, 3-pin	<b>CONG10-S5</b>	<b>CONG10-A5</b>	<b>CONM13NF-S5</b>	<b>CONM13NF-A5</b>
10 m cable, 3-pin			<b>CONM13NF-S10</b>	<b>CONM13NF-A10</b>
2 m cable, 4-pin	<b>CONG1A-S2</b>	<b>CONG1A-A2</b>	<b>CONM14NF-S2</b>	<b>CONM14NF-A2</b>
5 m cable, 4-pin	<b>CONG1A-S5</b>	<b>CONG1A-A5</b>	<b>CONM14NF-S5</b>	<b>CONM14NF-A5</b>
10 m cable, 4-pin			<b>CONM14NF-S10</b>	<b>CONM14NF-A10</b>
2 m cable, 5-pin			<b>CONM15NF-S2</b>	<b>CONM15NF-A2</b>
5 m cable, 5-pin			<b>CONM15NF-S5</b>	<b>CONM15NF-A5</b>
10 m cable, 5-pin			<b>CONM15NF-S10</b>	<b>CONM15NF-A10</b>
Degree of protection	IP 67	IP 67	IP 67	IP 67



Dimensions (mm)	-	65 x 27 x 130	Straight M12 connector	Angled M12 connector
Used for	Cylindrical 4 - 30 mm sensor	Testing sensor	4-wire DC	4-wire DC
Item number	<b>AMB4-30</b>	<b>ST-03</b>	<b>CONM14NF-S</b>	<b>CONM14NF-A</b>
No cable 4-pin				
Description	Universal sensor mounting bracket	Sensor tester for: NAMUR and 2-, 3- or 4-wire DC NPN/PNP and NO/NC with LED and Buzzer	Terminal connection	Terminal connection
Degree of protection			IP 67	IP 67

# Connectors and brackets

## Brackets angled



Steel, galvanized	<b>AMB8-A</b>	<b>AMB12-A</b>	<b>AMB18-A</b>	<b>AMB30-A</b>
Stainless steel AISI316L	-	<b>AMB12-A316L</b>	<b>AMB18-A316L</b>	-
Used for	M8 sensors	M12 sensors	M18 sensors	M30 sensors
Description	Mounting bracket	Mounting bracketd	Mounting bracket	Mounting bracket

## Brackets straight



Steel, galvanized	<b>AMB8-S</b>	<b>AMB12-S</b>	<b>AMB18-S</b>	<b>AMB30-S</b>
Stainless steel AISI316L	-	<b>AMB12-S316L</b>	<b>AMB18-S316L</b>	-
Used for	M8 sensors	M12 sensors	M18 sensors	M30 sensors
Description	Mounting bracket	Mounting bracket	Mounting bracket	Mounting bracket

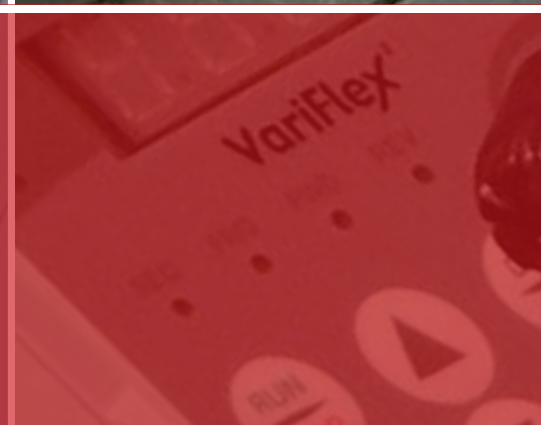

Alarm Indications (Red LED)



No of Flashes	Alarm Condition
1	Wrong Phase Sequence
2	Low Voltage / Out of Range
4	Frequency Out of Range
5	Lock of Motor (Condition Alarm / Alarm)
6	Overload / Over Temperature

# Switches

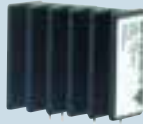

Solid state relays	104
Solid state relays accessories	134
Soft starters	139
Motor protection relays	143
Variable speed drives	145
Limit switches	149
Electromechanical relays	158
Sockets for electromechanical relays	161

# Solid state relays PCB type, 1-phase



	AC output switching			DC output switching
Types	RP1A - RP1B 3/5/5.5 AAC	RP..10 10 AAC	RAP 3/5 AAC	RP1D 1/4/8 ADC
PCB mounting SSRs, AC and DC operating. Rated isolation voltage $\geq 4000$ Vrms				
Dimensions H x W x D (mm)	25.4 x 43 x 10.5	37 x 43 x 22	25.4 x 43 x 10.5	25.4 x 43 x 10.5
Features	Standard AC switching SSR	With integral heatsink	LED indication High blocking voltage	DC switching SSR
<b>Input specifications</b>				
Control input range	3-32 VDC [RP1A23..] 3-32 VDC [RP1A40..] 4-32 VDC [RP1A48..] 15-32 VAC [RP1A23A6]	3-32 VDC [RP1A23..] 4-32 VDC [RP1A40..] 4-32 VDC [RP1A48..]	3.5-40 VDC [RAP40..] 4.5-40 VDC [RAP48..]	4.5 - 32 VDC
Max. input current	10 mA	10 mA	12 mA	15 mA
<b>Output specifications</b>				
Rated operational current				DC1: 1/4/8 ADC
AC 51 @ Ta=25°C	3 A [RP1...3] 5 A [RP1...5] 5.5 A [RP1...6]	10 A	3 A [RAP...A3] 5 A [RAP...A5]	
AC 53a @ Ta=25°C	2 A [RP1...3] 3 A [RP1...5] 5 A [RP1...6]	7 A	2.5 A [RAP...A3] 3 A [RAP...A5]	
Min. operational current	20 mA	10 mA	20 mA	1 mADC
Non rep. surge current (t=20 ms)	65 A <sub>p</sub> [RP1...3] 80 A <sub>p</sub> [RP1...5] 250 A <sub>p</sub> [RP1...6]	250 A <sub>p</sub>	60 A <sub>p</sub> [RAP...A3] 90 A <sub>p</sub> [RAP...A5]	
Off-state leakage current	$\leq 1$ mA	$\leq 3$ mA	$\leq 1$ mA	0.01 mADC
I <sup>2</sup> t for fusing (t=10 ms)	20 A <sup>2</sup> s [RP1...3] 50 A <sup>2</sup> s [RP1...5] 340 A <sup>2</sup> s [RP1...6]	340 A <sup>2</sup> s	18 A <sup>2</sup> s [RAP...A3] 40 A <sup>2</sup> s [RAP...A5]	
Critical dV/dt off-state	250 V/ $\mu$ s [RP1...3] 500 V/ $\mu$ s [RP1...5] 500 V/ $\mu$ s [RP1...6]	1000 V/ $\mu$ s	100 V/ $\mu$ s	
<b>General specifications</b>				
Operational voltage range	12-265 Vrms [RP1A23..] 20-440 Vrms [RP1A40..] 20-530 Vrms [RP1A48..]	12-265 Vrms [RP1A23..] 20-440 Vrms [RP1A40..] 20-530 Vrms [RP1A48..]	10-440 Vrms [RAP40..] 20-530 Vrms [RAP48..]	1 - 60 VDC [RP1D060...] 1 - 350 VDC [RP1D350...]
Blocking voltage	650 V <sub>p</sub> [RP1A23..] 850 V <sub>p</sub> [RP1A40..] 1000 V <sub>p</sub> [RP1A48..]	650 V <sub>p</sub> [RP1A23..] 850 V <sub>p</sub> [RP1A40..] 1000 V <sub>p</sub> [RP1A48..]	1000 V <sub>p</sub> [RAP40..] 1200 V <sub>p</sub> [RAP48..]	
Power factor	0.5	0.5	0.2	0.5
Operating temperature	-20°C to +70°C	-30°C to +80°C	-20°C to +70°C	-20°C to +80°C
Terminals	4 pins x $\varnothing$ 0.1 mm	4 pins x $\varnothing$ 0.1 mm	4 pins x $\varnothing$ 0.1 mm	4 pins x $\varnothing$ 0.1 mm
Approvals/Marks	CE - UR - cUR - VDE	CE - UR - cUR	CE - UR - CSA - VDE	CE - UR - cUR
<b>References</b>				
	3 A	10 A	3 A	1 A
	RP1A23D3	RP1A23D10	RAP40A3	RP1D350D1
	RP1A40D3	RP1A40D10	RAP48A3	
	RP1A48D3	RP1A48D10		4 A
	5 A		5 A	RP1D060D4
	RP1A23D5		RAP40A5	
	RP1A40D5		RAP48A5	8 A
	RP1A48D5			RP1D060D8
	5.5 A			
	RP1A23D6			
	RP1A23A6			
	RP1A40D6			
	RP1A48D6			

\* Other options available on request: Instant-on switching (RP1B..), see Accessories for DIN-rail adaptor.



# Solid state relays, 1-phase

## Slimline - AC output switching

Types	<b>RGS1A..KKE</b> 25/50/75/90 AAC	<b>RGS1A..KGE</b> 50/90 AAC	<b>RGS1A..MKE</b> 25/50/90 AAC
Single phase, chassis mounting with LED for control status indication, IP20 protection, 45-65 Hz operating frequency, $\geq 4000$ VACrms isolation voltage, 100 kArms short circuit current rating, certified motor ratings			
Dimensions (mm)	90 x 17.8 x 50.6	90 x 17.8 x 50.6	90 x 17.8 x 63.6
Features	17.8 mm wide solid state relay with integrated varistor on output, AC or DC control range, screw terminals with captivated clamp for power and control connections, E-type layout	17.8 mm wide solid state relay with integrated varistor on output, AC or DC control range, box clamp for power connections (up to 25 mm <sup>2</sup> /AWG3), screw for control connections, E-type layout	17.8 mm wide solid state relay with integrated varistor on output, AC or DC control range, screw terminals with captivated clamp for power connections and pluggable spring for control, E-type layout
<b>Input specifications</b>			
Control input range	3-32 VDC [RG.23D.] / 4-32 VDC [RG.60D.] 20-275 VAC, 24-190 VDC [RG..A.]	4-32 VDC [RG..D.] 20-275 VAC, 24-190 VDC [RG..A.]	3-32 VDC [RG..23D..], 4-32 VDC [RG..60D..] 20-275 VAC, 24-190 VDC [RG..A.]
Max. input current	11 mA DC [RG..D.] 30 mA AC [RG..A.]	11 mA DC [RG..D.] 30 mA AC [RG..A.]	11 mA DC [RG..D.] 30 mA AC [RG..A.]
<b>Output specifications</b>			
Rated operational current AC-51 @ Ta=40°C	25 AAC [RG..25] / 50 AAC [RG..50/51] 75 AAC [RG..75] / 90 AAC [RG..90/91/92]	50 AAC [RG..50] 90 AAC [RG..92]	25 AAC [RG..25] / 50 AAC [RG..50] 90 AAC [RG..90/92]
AC-53a @ Ta=40°C	5 AAC [RG..25] / 10 AAC [RG..50/51] 14.8 AAC [RG..75] / 18 AAC [RG..90/91/92]	10 AAC [RG..50] 18 AAC [RG..92]	5 AAC [RG..25] / 10 AAC [RG..50] 18 AAC [RG..90/92]
Min. operational current	150 mA AC [RG..25] / 250 mA AC [RG..50/51] 400 mA AC [RG..75] / 500 mA AC [RG..90/91/92]	250 mA AC [RG..50] 500 mA AC [RG..92]	150 mA AC [RG..25] / 250 mA AC [RG..50] 500 mA AC [RG..90/92]
Non rep. surge current (t=10 ms)	325 Ap [RG..25] / 600 Ap [RG..50/51] 800 Ap [RG..75] / 1150 Ap [RG..90/91] 1900 Ap [RGS..92]	600 Ap [RG..50] 1900 Ap [RG..92]	325 Ap [RG..25] / 600 Ap [RG..50] 1150 Ap [RG..90] / 1900 Ap [RG..92]
Max. Off-state leak current	3 mA AC	3 mA AC	3 mA AC
I <sup>2</sup> t for fusing (t=10 ms)	525 A <sup>2</sup> s [RG..25] / 1800 A <sup>2</sup> s [RG..50/51] 3200 A <sup>2</sup> s [RG..75] / 6600 A <sup>2</sup> s [RG..90/91] 18000 A <sup>2</sup> s [RGS..92]	1800 A <sup>2</sup> s [RG..50] 18000 A <sup>2</sup> s [RG..92]	525 A <sup>2</sup> s [RG..25] / 1800 A <sup>2</sup> s [RG..50] 6600 A <sup>2</sup> s [RG..90] / 18000 A <sup>2</sup> s [RG..92]
Critical dV/dt (@ Tj init = 40°C)	1000 V/μs	1000 V/μs	1000 V/μs
<b>General specifications</b>			
Operational voltage range	24-240 VAC +10% [RG.23..] 42-600 VAC +10% [RG.60...]	42-600 VAC +10%	24-240 VAC +10% [RG..23..] 42-600 VAC +10% [RG..60...]
Blocking voltage	800 Vp [RG..23..] 1200 Vp [RG..60..] 1600 Vp [RG..60..51/91]	1200 Vp	800 Vp [RG..23..] 1200 Vp [RG..60..]
Power factor	$\geq 0.5$ at rated voltage	$\geq 0.5$ at rated voltage	$\geq 0.5$ at rated voltage
Operating temperature	-40°C to +80°C	-40°C to +80°C	-40°C to +80°C
Approvals/Marks	CE - cURus - CSA - VDE	CE - cURus - CSA - VDE	CE - cURus - CSA - VDE
<b>References</b>			
230 VAC, 800 Vp	25 AAC: <b>RGS1A23X25KKE</b>		25 AAC: <b>RGS1A23X25MKE</b>
	50 AAC: <b>RGS1A23X50KKE</b>		50 AAC: <b>RGS1A23X50MKE</b>
	75 AAC: <b>RGS1A23X75KKE</b>		
600 VAC, 1200 Vp	25 AAC: <b>RGS1A60X25KKE</b>		25 AAC: <b>RGS1A60X25MKE</b>
	50 AAC: <b>RGS1A60X50KKE</b>	50 AAC: <b>RGS1A60X50KGE</b>	50 AAC: <b>RGS1A60X50MKE</b>
	75 AAC: <b>RGS1A60X75KKE</b>		
	90 AAC: <b>RGS1A60X90KKE</b>		90 AAC: <b>RGS1A60X90MKE</b>
	90 AAC: <b>RGS1A60X92KKE</b>	90 AAC: <b>RGS1A60X92KGE</b>	90 AAC: <b>RGS1A60X92MKE</b>
600 VAC, 1600 Vp	50 AAC: <b>RGS1A60X51KKE</b>		
	90 AAC: <b>RGS1A60X91KKE</b>		



X must be replaced with D for DC control 3-32 VDC, 4-32 VDC (for 600 VAC versions)

X must be replaced with A for AC control 20-275 VAC, 24-190 VDC

RGS1B.. models for Instant On (Random) switching are available on request

# Solid state relays, 1-phase

## Slimline - AC output switching



Types	<b>RGS1A..MGE</b> 50/90 AAC	<b>RGS1A..KGU</b> 20/30 AAC	<b>RGS1A..DIN</b> 10/12 AAC
Single phase, chassis mounting with LED for control status indication, IP20 protection, 45-65 Hz operating frequency, $\geq 4000$ VACrms isolation voltage, 100 kArms short circuit current rating, certified motor ratings			
Dimensions (mm)	90 x 17.8 x 63.6	90 x 17.8 x 50.6	106 x 17.8 x 65
Features	17.8 mm wide solid state relay with integrated varistor on output, AC or DC control range, box clamps for power connections (25 mm <sup>2</sup> / AWG3) and pluggable spring for control, E-type layout	17.8 mm wide solid state relay with integrated varistor on output, AC or DC control range, box clamps for power and control connections, U-type layout	17.8 mm wide solid state relay mounted on DIN mountable module
<b>Input specifications</b>			
Control input range	4-32 VDC [RG..D..] 20-275 VAC, 24-190 VDC [RG..A..]	3-32 VDC [RG..23D..] 4-32 VDC [RG..60D..] 20-275 VAC, 24-190 VDC [RG..A..]	3-32 VDC [RG..23D..] 4-32 VDC [RG..60D..] 20-275 VAC, 24-190 VDC [RG..A..]
Max. input current	11 mADC [RG..D..] 30 mAAC [RG..A..]	11 mADC [RG..D..] 30 mAAC [RG..A..]	11 mADC [RG..D..] 30 mAAC [RG..A..]
<b>Output specifications</b>			
Rated operational current AC-51 @ Ta=40°C	50 AAC [RG..50] 90 AAC [RG..92]	20 AAC [RG..20] 30 AAC [RG..30]	10 AAC [RG..20/25..DIN] 12 AAC [RG..50/90..DIN]
AC-53a @ Ta=40°C	10 AAC [RG..50] 18 AAC [RG..92]	5 AAC [RG..20] 8 AAC [RG..30]	5 AAC [RG..20/25..DIN] 5 AAC [RG..50/90..DIN]
Min. operational current	250 mAAC [RG..50] 500 mAAC [RG..92]	150 mAAC [RG..20] 250 mAAC [RG..30]	150 mAAC [RG..20/25..DIN] 250 mAAC [RG..50..DIN] 400 mAAC [RG..90..DIN]
Non rep. surge current (t=10 ms)	600 Ap [RG..50] 1900 Ap [RG..92]	325 Ap [RG..20] 600 Ap [RG..30]	325 Ap [RG..20/25..DIN] 600 Ap [RG..50..DIN] 1150 Ap [RG..90..DIN]
Max. Off-state leak current	3 mAAC	3 mAAC	3 mAAC
I <sup>2</sup> t for fusing (t=10 ms)	1800 A <sup>2</sup> s [RG..50] 18000 A <sup>2</sup> s [RG..92]	525 A <sup>2</sup> s [RG..20] 1800 A <sup>2</sup> s [RG..30]	525 A <sup>2</sup> s [RG..20/25..DIN] 1800 A <sup>2</sup> s [RG..50..DIN] 6600 A <sup>2</sup> s [RG..90..DIN]
Critical dV/dt (@ Tj init=40°C)	1000 V/μs	1000 V/μs	1000 V/μs
<b>General specifications</b>			
Operational voltage range	42-600 VAC +10%	24-240 VAC +10% [RG..23..] 42-600 VAC +10% [RG..60...]	24-240 VAC +10% [RG..23..] 42-600 VAC +10% [RG..60..]
Blocking voltage	1200 Vp	800 Vp [RGS..23..] 1200 Vp [RGS..60..]	800 Vp [RG..23..] 1200 Vp [RG..60..]
Power factor	$\geq 0.5$ at rated voltage	$\geq 0.5$ at rated voltage	$\geq 0.5$ at rated voltage
Operating temperature	-40°C to +80°C	-40°C to +80°C	-40°C to +80°C
Approvals/Marks	CE - cURus - CSA - VDE	CE - cURus - CSA - VDE	CE - cURus - CSA - VDE
<b>References</b>			
230 VAC, 800 Vp, E-type			10 AAC: <b>RGS1A23X25KKEDIN</b> 12 AAC: <b>RGS1A23X50KKEDIN</b>
600 VAC, 1200 Vp, E-type	50 AAC: <b>RGS1A60X50MGE</b> 90 AAC: <b>RGS1A60X92MGE</b>		10 AAC: <b>RGS1A60X25KKEDIN</b> 12 AAC: <b>RGS1A60X50KKEDIN</b> 12 AAC: <b>RGS1A60D90KKEDIN</b>
230 VAC, 800 Vp, U-type		20 AAC: <b>RGS1A23X20KGU</b> 30 AAC: <b>RGS1A23X30KGU</b>	10 AAC: <b>RGS1A23D20KGUDIN</b>
600 VAC, 1200 Vp, U-type		20 AAC: <b>RGS1A60X20KGU</b> 30 AAC: <b>RGS1A60X30KGU</b>	

X must be replaced with D for DC control 3-32 VDC, 4-32 VDC (for 600 VAC versions)  
X must be replaced with A for AC control 20-275 VAC, 24-190 VDC  
RGS1B.. models for Instant On (Random) switching are available on request

# Solid state relays, 1-phase

## Slimline - DC output switching

## Slimline - AC output switching integrated current measurement





Types	<b>RGS1D..KKE</b> 15/25 ADC	<b>RGS1S..EP</b> 20/30/90 AAC	<b>RGS1S..UP</b> 65 AAC
Single phase, chassis mounting industrial relays with LED for control status indication and IP20 protection, Rated isolation voltage $\geq 4000$ Vrms, 100 kArms Short Circuit Current Rating for AC switching versions			
Dimensions HxWxD (mm)	90 x 17.8 x 50.6	90 x 22.5 x 78	90 x 35.6 x 78
Features	17.8 mm wide solid state relay with IGBT output, integrated free wheeling diode, DC control voltage, screw terminals with captivated clamp, E-type layout	22.5 mm wide solid-state relay with thyristor output, integrated varistor, DC control, local or remote TEACH, detection of partial load failure (1/6), SSR and load malfunction, SSR overheat protection.	35 mm wide solid-state relay with thyristor output, integrated varistor, DC control, local or remote TEACH, detection of partial load failure (1/6), SSR and load malfunction, SSR overheat protection.
<b>Input specifications</b>			
Control input range	4.5-32 VDC	4-32 VDC	4-32 VDC
Max. input current	13.7 mADC	10 mADC at 24 VDC	10 mADC at 24 VDC
Supply voltage		24 VDC -15%, +20%	24 VDC -15%, +20%
Max. supply current		50 mADC	50 mADC
<b>Alarm specifications</b>			
Output type		NC PNP open collector max. 35 VDC / 50 mA	NC PNP open collector max. 35 VDC / 50 mA
Alarm Indication		Red LED (flash rate)	Red LED (flash rate)
<b>Output specifications</b>			
Rated operational current AC-51 @ Ta=40°C		20 AAC [RGS1S..20] 30 AAC [RGS1S..30 / 31] 90 AAC [RGS1S..92]	65 AAC
DC Rated operational current	15 ADC [RGS1D..15.] 25 ADC [RGS1D..25.]		
Minimum TEACH / operational current	20 mA	1.2 AAC [RGS1S..20/30/31] 5 AAC [RGS1S..92]	5 AAC
Minimum partial load current		0.2 AAC [RGS1S..20/30/31] 0.83 AAC [RGS1S..92]	0.83 AAC
Detectable partial load failure		>16.67% from current setpoint	>16.67% from current setpoint
Non rep. surge current (I <sub>sm</sub> ) (t=10 ms)	200 ADC [10µs]	325 A <sub>p</sub> [RGS1S..20] - 600 A <sub>p</sub> [RGS1S..30] 1150 A <sub>p</sub> [RGS1S..31] - 1900 A <sub>p</sub> [RGS1S..92]	1900 A <sub>p</sub>
Max. Off-state leak current	1.5 mADC	3 mAAC	3 mAAC
I <sup>2</sup> t for fusing (t=10 ms)		525 A <sup>2</sup> s [RGS1S..20] - 1800 A <sup>2</sup> s [RGS1S..30] 6600 A <sup>2</sup> s [RGS1S..31] - 18000 A <sup>2</sup> s [RGS1S..92]	18000 A <sup>2</sup> s
Critical dV/dt (@ T <sub>j</sub> init = 40°C)		1000 V/µs	1000 V/µs
<b>General specifications</b>			
Operational voltage range	24-1000 VDC [CE] 24-600 VDC [UL508]	42-600 VAC +10%	42-600 VAC +10%
Blocking voltage	1200 VDC	1200 V <sub>p</sub>	1200 V <sub>p</sub>
Power factor		$\geq 0.9$ at rated voltage	$\geq 0.9$ at rated voltage
Operating temperature	-40°C to +80°C	-25°C to +70°C	-25°C to +70°C
Approvals/Marks	CE - cURus - CSA	CE - cURus - CSA	CE - cURus - CSA
<b>References</b>			
1000 VDC	15 ADC: <b>RGS1D1000D15KKE</b> 25 ADC: <b>RGS1D1000D25KKE</b>		
600 VAC, 525 A <sup>2</sup> s, E-type		20 AAC: <b>RGS1S60D20GKEP</b>	
600 VAC, 1800 A <sup>2</sup> s, E-type		30 AAC: <b>RGS1S60D30GKEP</b>	
600 VAC, 6600 A <sup>2</sup> s, E-type		30 AAC: <b>RGS1S60D31GKEP</b>	
600 VAC, 18000 A <sup>2</sup> s, E-type		90 AAC: <b>RGS1S60D92GGEP</b>	
600 VAC, 18000 A <sup>2</sup> s, U-type			65 AAC: <b>RGS1S60D61GGUP</b>

KK = screws for control terminals, screws for power terminals  
 GK = box clamps for control terminals, screws for power terminals  
 GG = box clamps for control terminals, box clamps for power terminals

CARLO GAVAZZI Automation Components. Specifications are subject to change without notice. Illustrations are for example only.

# Solid state relays, 1-phase

## Industrial housing - AC output switching

Types	RF1A 25 AAC	RS1A 10/25/40 AAC	RAM1A 25/50/75/100/125 AAC	RAM1A..G 25/50/100/125 AAC
Single phase, chassis mounting, industrial relays with LED status indication and IP 20 protection. AC operating frequency range 45-65 Hz. Rated isolation voltage $\geq 4000$ Vrms				
Dimensions HxWxD (mm)	36 x 21 x 24	58.2 x 44.8 x 28.8	58.2 x 44.8 x 28.8	58.2 x 44.8 x 28.8
Features	Zero Cross or Instant ON, Built-in transistor, VDE, Glow wire acc. to IEC/EN 60335-1	Zero Cross, Ideal for Ohmic loads	Zero Cross or Instant ON, Built-in snubber, VDE	Zero Cross, Built-in varistor, VDE, Glow wire acc. to IEC/EN 60335-1

### Input specifications

Control input range	4.25 - 9 VDC [RF1A..L] 9 - 18 VDC [RF1A..M] 18 - 28.8 VDC [RF1A..D]	3-32 VDC [RS1A23D] 4-32 VDC [RS1A....D] 18-36 VAC/DC [RS1A...LA] 80-130 VAC [RS1A..A1-] 200-260 VAC [RS1A..A2-] 360-440 VAC [RS1A..A4-]	3-32 VDC [RAM1A23D..] 4-32 VDC [RAM1A60D..] 20-280 VAC / 22-48 VDC [RAM1A..A.]	3-32 VDC [RAM1A23D..] 4-32 VDC [RAM1A60D..] 20-280 VAC / 22-48 VDC [RAM1A..A.]
Max. input current	15 mA [RF1A..L] 12 mA [RF1A..M] 12.5 mA [RF1A..D]	12 mA [RS1A..D] 15 mA [RS1A..LA] 13 mA [RS1A...A1-/A2-/A4-]	12 mA [RAM1A..D.] 20 mA [RAM1A..A.]	12 mA [RAM1A..D.] 20 mA [RAM1A..A.]

### Output specifications

	RF1A	RS1A..10 / 25 / 40	RAM1A..25 / 50 / 75 / 100 / 125	RAM1A..25/50/51/100/125
Rated operational current				
AC 51 @ Ta=25°C	25 AAC	10 / 25 / 40 AAC	25 / 50 / 75 / 100 / 125 AAC	25 / 50 / 50 / 100 / 125 AAC
AC 53a @ Ta=25°C			5 / 15 / 17 / 20 / 30 AAC	5 / 15 / 15 / 20 / 30 AAC
Min. operational current	150 mAAC	150 / 150 / 250 mAAC	150 / 250 / 400 / 400 / 500 mAAC	150 / 250 / 400 / 400 / 500 mAAC
Non rep. surge current (t=10 ms)	325 Ap	100 / 325 / 600 Ap	325 / 600 / 800 / 1150 / 1900 Ap	325 / 600 / 800 / 1150 / 1900 Ap
Off-state leakage current	< 3 mA	< 3 mA	< 3 mA	< 3 mA
I <sup>2</sup> t for fusing (t=10 ms)	525 A <sup>2</sup> s	50 / 525 / 1800 A <sup>2</sup> s	525 / 1800 / 3200 / 6600 / 18000 A <sup>2</sup> s	525 / 1800 / 3200 / 6600 / 18000 A <sup>2</sup> s
Critical dV/dt	1000 V/μs	500 V/μs	1000 V/μs	1000 V/μs

### General specifications

Operational voltage range	24 - 280 VAC	42-265 VAC [RS1A23..] 42-440 VAC [RS1A40..] 42-530 VAC [RS1A48..]	24-265 VAC [RAM1A23..] 42-660 VAC [RAM1A60..] 42-760 VAC [RAM1A69..]	24-265 VAC [RAM1A23..] 42-660 VAC [RAM1A60..]
Blocking voltage	600Vp	650 Vp [RS1A23..] 850 Vp [RS1A40..] 1200 Vp [RS1A48..]	650 Vp [RAM1A23..] 1200 Vp [RAM1A60..] 1600 Vp [RAM1A69..]	650 Vp [RAM1A23..] 1200 Vp [RAM1A60..]
Power factor	$\geq 0.9$	$\geq 0.95$	$\geq 0.5$	$\geq 0.5$
Operating temperature	-30°C to +80°C	-20°C to +70°C	-40°C to +80°C	-40°C to +80°C
Terminals	FASTONS	Screw type with clamp	Screw type with clamp	Screw type with clamp
Approvals/Marks	CE - UR - CSA - VDE	CE - UR - CSA	CE - UR - CSA - CCC - VDE*	CE - UR - CSA - CCC - VDE

### References

	RF1A	RS1A	RAM1A	RAM1A..G
230 VAC	25 AAC <b>RF1A23L25</b> <b>RF1A23M25</b> <b>RF1A23D25</b>	10 / 25 / 40 AAC <b>RS1A23X10</b> (X = D, LA only) <b>RS1A23X25</b> <b>RS1A23X40</b>	25 / 50 / 75 / 100 / 125 AAC <b>RAM1A23DYY</b> <b>RAM1A23AYY</b>	25 / 50 / 100 / 125 AAC <b>RAM1A23DYYG</b> <b>RAM1A23AYYG</b>
400 VAC		<b>RS1A40X10</b> (X = D, LA only) <b>RS1A40X25</b> <b>RS1A40X40</b>		
480 VAC		<b>RS1A48X10</b> (X = D, LA only) <b>RS1A48X25</b> (X = D, LA only) <b>RS1A48X40</b> (X = D, LA only)		
600 VAC			<b>RAM1A60DYY</b> <b>RAM1A60AYY</b>	<b>RAM1A60DYYG</b> <b>RAM1A60AYYG</b>
690 VAC			<b>RAM1A69DYY</b> <b>RAM1A69AYY</b>	

RF1B.., RAM1B.. Instant On switching versions available on request.

\* 690 VAC CE marked only.

X = D for DC control = 3-32VDC (RS1A23..), 4-32VDC (RS1A40.., RS1A48..)

X = LA for AC control = 18-36VAC/DC

X = A1- for AC control = 80-130VAC (not available for RS1A40..)

X = A2- for AC control = 200-260VAC

X = A4- for AC control = 360-440VAC

YY = 25 for 25AAC

YY = 50 for 50AAC



YY = 51 for 50AAC high I<sup>2</sup>t (RAM1A60..G only)

YY = 75 for 75AAC

YY = 100 for 100AAC (not available for RAM1A23..G)

YY = 125 for 125AAC (not available for RAM1A23..G)

# Solid state relays, 1-phase

	Industrial housing zero/instant ON switching	Industrial housing peak switching	Industrial housing phase angle switching
Types	RM1A 25/50/75/100 AAC	RM1C 25/50/75/100 AAC	RM1E 25/50/100 AAC
Single phase, chassis mounting, industrial relays with LED status indication and IP20 protection AC operating frequency range 45-65 Hz. Rated isolation voltage $\geq 4000$ Vrms			
Dimensions HxWxD (mm)	58.2 x 44.8 x 28.8	58.2 x 44.8 x 28.8	58.2 x 44.8 x 28.8
Features	Zero Cross or Instant ON, Built-in varistor	Ideal for transformers	Analog Phase-angle control

## Input specifications

Control input range	3-32 VDC [RM1A23D.] 4-32 VDC [RM1A60D.] 20-280 VAC/22-48 VDC [RM1A..A.] 4.25-36 VDC/4.25-27 VAC [RM1A..M.]	4.25-32 VDC	4-20 mA [RM1E..AA..] 0-10 VDC [RM1E..V..]
Max. input current	12mA [RM1A..D.] 20mA [RM1A..A.] 18mA [RM1A..M.]	18 mA	0.15 mA [RM1E..V..]
Supply voltage range			24 VDC [RM1E..V..]
Max. supply input current			20 mA [RM1E..V..]

## Output specifications

	RM1A..25 / 50 / 75 / 100	RM1C..25 / 50 / 75 / 100	RM1E..25 / 50 / 100
Rated operational current			
AC 51 @ $T_a=25^\circ\text{C}$	25 / 50 / 75 / 100 AAC	25 / 50 / 75 / 100 AAC	25 / 50 / 100 AAC
AC 53a @ $T_a=25^\circ\text{C}$	5 / 15 / 20 / 30 AAC		5 / 15 / 20 AAC
AC 56a @ $T_a=25^\circ\text{C}$		10 / 20 / 25 / 30 AAC	
Min. operational current	150 / 250 / 400 / 500 mAAC	150 / 250 / 400 / 500 mAAC	150 / 250 / 400 mAAC
Non rep. surge current (t=10 ms)	325 / 600 / 1150 / 1900 A <sub>p</sub>	325 / 600 / 1150 / 1900 A <sub>p</sub>	325 / 600 / 1150 A <sub>p</sub>
Off-state leakage current	< 3 mA	< 3 mA	< 3 mA
I <sup>2</sup> t for fusing (t=10 ms)	525 / 1800 / 6600 / 18000 A <sup>2</sup> s	525 / 1800 / 6600 / 18000 A <sup>2</sup> s	525 / 1800 / 6600 A <sup>2</sup> s

## General specifications

Operational voltage range	24-265 VAC [RM1A23..] 42-440 VAC [RM1A40..] 42-530 VAC [RM1A48..] 42-660 VAC [RM1A60..]	100-440 VAC [RM1C40D.] 340-660 VAC [RM1C60D.]	90-280 VAC [RM1E23AA..] 340-460 VAC [RM1E40AA..] 200-550 VAC [RM1E48AA..] 410-660 VAC [RM1E60AA..] 90-265 VAC [RM1E23V..] 200-550 VAC [RM1E48V..] 410-660 VAC [RM1E60V..]
Blocking voltage	650 V <sub>p</sub> [RM1A23..] 850 V <sub>p</sub> [RM1A40..] 1200 V <sub>p</sub> [RM1A48..] 1400 V <sub>p</sub> [RM1A60..]	850 V <sub>p</sub> [RM1C40D..] 1400 V <sub>p</sub> [RM1C60D..]	650 V <sub>p</sub> [RM1E23..] 850 V <sub>p</sub> [RM1E40..] 1200 V <sub>p</sub> [RM1E48..] 1400 V <sub>p</sub> [RM1E60..]
Power factor	$\geq 0.5$	$\geq 0.5$	$\geq 0.75$
Operating temperature	-20°C to +70°C	-30°C to +80°C	-20°C to +70°C
Terminals	Screw type with clamp	Screw type with clamp	Screw type with clamp
Approvals/Marks	CE - UR - CSA - CCC	CE - UR - CSA	CE - UR - CSA





## References 1-phase:

	25 / 50 / 75 / 100 AAC	25 / 50 / 75 / 100 AAC	25 / 50 / 100 AAC
230 Vrms	RM1A23XY		RM1E23X25 (X = AA or V) RM1E23X50 (X = AA or V) RM1E23X100 (X = AA or V)
	RM1A40XY	RM1C40D25 RM1C40D50 RM1C40D75	RM1E40AA25 RM1E40AA50 RM1E40AA100
	RM1A48XY		RM1E48X25 (X = AA or V) RM1E48X50 (X = AA or V) RM1E48X100 (X = AA or V)
600 Vrms	RM1A60XY	RM1C60D25 RM1C60D50 RM1C60D100	RM1E60X25 (X = AA or V) RM1E60X50 (X = AA or V) RM1E60X100 (X = AA or V)

RM1B.. Instant On switching versions available on request X = D for DC control = 3-32VDC (RM1A23..), 4-32VDC (RM1A40.., RM1A48.., RM1A60..) X = M for low AC control = 4.25-36VDC / 4.25-27VAC YY = 25 for 25 AAC YY = 50 for 50 AAC YY = 75 for 75 AAC YY = 100 for 100 AAC

# Solid state relays, 1 / 2-poles

## Industrial housing - AC output switching

Types	RA Sense 25/50/90/110 AAC	RA Low Noise 10/25 AAC	RA2A 25/40 AAC	RA2A..C 25/40 AAC
Single Phase relays with special functions. 2 Phase industrial relays				
Dimensions HxWxD (mm)	58.2 x 44.8 x 28.8	58.2 x 44.8 x 28.8	57.8 x 44.5 x 31.7	57.8 x 44.5 x 34.8
Features	Detects supply and load failure	Complies with EN55022	Two independent poles, RA2A..M for inductive loads	Two independent poles, faston terminals for power, pin connectors for control

### Input Specifications

Control input range	7-32 VDC	3-32 VDC	4.5-32 VDC	4.5-32 VDC
Max. input current	4 mA	32 mA	2 x 10 mA	2x 10 mA
Control supply	20-32 VDC (40 mA)			
Alarm output	PNP NPN	VCC - 2 VDC (100 mA) 2 VDC (100 mA)		

### Output Specifications

Rated operational current AC 51 @ Ta=40°C	25 / 50 / 90 / 110 AAC	10 / 25 AAC	25 / 40 AAC per pole	25 / 40 AAC per pole
AC 53a @ Ta=40°C			5 / 15 AAC per pole [RA2A..M]	
Min. operational current	200 mArms	2 Arms	150 mArms [RA2A...25] 250 mArms [RA2A...40]	150 mArms [RA2A...25C] 250 mArms [RA2A...40C]
Non rep. surge current (t=10 ms)	325 Ap [RA..25..S] 600 Ap [RA..50..S] 1150 Ap [RA..90..S] 1900 Ap [RA..110..S]	90 Ap, t=20 ms [RA..10..L] 200 Ap, t=20 ms [RA..25..L]	325 Ap [RA2A..25] 600 Ap [RA2A..40] 325 Ap [RA2A..25M] 600 Ap [RA2A..40M]	325 Ap [RA2A...25C] 600 Ap [RA2A...40C]
Off-state leakage current	< 6 mArms	< 1 mArms	< 3 mArms	< 3 mArms
I <sup>2</sup> t for fusing (t=10 ms)	525 A <sup>2</sup> s [RA..25..S] 1800A <sup>2</sup> s [RA..50..S] 6600 A <sup>2</sup> s [RA..90..S] 18000 A <sup>2</sup> s [RA..110..S]	120 A <sup>2</sup> s [RA..10..L] 200A <sup>2</sup> s [RA..25..L]	525 A <sup>2</sup> s [RA2A..25] 1800 A <sup>2</sup> s [RA2A..40] 525 A <sup>2</sup> s [RA2A..25M] 1800A <sup>2</sup> s [RA2A..40M]	525 A <sup>2</sup> s [RA2A..25C] 1800 A <sup>2</sup> s [RA2A..40C]



### General specifications

Operational voltage range	60-140 Vrms [RA12..S] 170-250 Vrms [RA23..S] 150-440 Vrms [RA40..S] 180-530 Vrms [RA48..S]	180-265 Vrms [RA24..L] 340-530 Vrms [RA40..L]	24-265 Vrms [RA2A23..] 42-440 Vrms [RA2A40..] 42-530 Vrms [RA2A48..] 42-660 Vrms [RA2A60..]	24-265 Vrms [RA2A23..] 42-660 Vrms [RA2A60..]
Blocking voltage	650 Vp [RA12..S] 650 Vp [RA23..S] 1000 Vp [RA40..S] 1200 Vp [RA48..S]	650 Vp [RA24..L] 850 Vp [RA40..L]	650 Vp [RA2A23..] 850 Vp [RA2A40..] 1200 Vp [RA2A48..] 1200 Vp [RA2A60..]	650 Vp [RA2A23..] 1200 Vp [RA2A60..]
Power factor	≥ 0.5	1	≥ 0.95 [RA2A...] ≥ 0.50 [RA2A...M]	≥ 0.95 at rated voltage
Operating temperature	-20°C to +70°C	-20°C to +70°C	-20°C to +70°C	-20°C to +70°C
Terminals	Screw / 5 way plug	Screw type with clamp	FASTONS 6.35 mm	FASTONS 6.35 mm / 4 way plug
Approvals/Marks	CE - UR - CSA	CE - UR - CSA - VDE	CE - UR - CSA	CE - cURus

### References

	25 / 50 / 90 / 110 AAC	10 / 25 AAC	25 / 40 AAC per pole	25 / 40 AAC per pole
120 Vrms	RA12..06..S			
230 Vrms	RA23..06..S	RA2410-D06L RA2425-D06L	RA2A23.. RA2A23..M	RA2A23D..C
400 Vrms	RA40..10..S	RA4010-D08L RA4025-D08L	RA2A40.. RA2A40..M	
480 Vrms	RA48..12..S		RA2A48.. RA2A48..M	
600 Vrms			RA2A60.. RA2A60..M	RA2A60D..C

# Solid state relays, 1 / 3-phase

	Industrial housing zero switching	Industrial housing DC switching	Industrial housing 3-phase switching
Types	<b>RA</b> 25/50/90/110 AAC	<b>RD</b> 1/5 ADC	<b>RZ3A</b> 25/55/75 AAC
Single phase and 3 phase industrial relays			
Dimensions HxWxD (mm)	58.2 x 44.8 x 28.8	58.2 x 44.8 x 28.8	74 x 103 x 41
Features	General purpose	Ideal for DC valve coils	3-phase switching
<b>Input specifications</b>			
Control input range	3-32 VDC [RA..D..] 10-90 VAC / DC [RA..LA..] 90-280 VAC / DC [RA..HA..]	3-32 VDC	4-32 VDC [RZ3A..D..] 24-275 Vrms [RZ3A..A.]
Max. input current	22 mA [RA..D..] 17 mA [RA..LA..] 6.5 mA [RA..HA..]	32 mA	23 / 15 mA
<b>Output specifications</b>			
Rated operational current			
AC 51 @ Ta=25°C	25 / 50 / 90 / 110 AAC	DC1: 1A / 5A	25 / 55 / 75 AAC
AC 53a @ Ta=25°C	5/15/ 20/30 AAC		5 / 15 / 20 AAC
Min. operational current	20 mA	1 mA	
Non rep. surge current (t=10 ms)	325 Ap [RA..25.] 600 Ap [RA..50.] 1150 Ap [RA..90.] 1900 Ap [RA..110.]		325 Ap [RZ3A..25..] 600 Ap [RZ3A..55..] 1150 Ap [RZ3A..75..]
Off-state leakage current	< 3 mA	< 1 mA	< 3 mA
I <sup>2</sup> t for fusing (t=10 ms)	<525 A <sup>2</sup> s [RA..25.] <1800 A <sup>2</sup> s [RA..50.] <6600 A <sup>2</sup> s [RA..90.] <18000 A <sup>2</sup> s [RA..110.]		525 A <sup>2</sup> s [RZ3A..25..] 1800 A <sup>2</sup> s [RZ3A..55..] 6600 A <sup>2</sup> s [RZ3A..75..]
<b>General specifications</b>			
Operational voltage range	24-280 Vrms [RA24.06..] 42-480 Vrms [RA44.08..] 42-530 Vrms [RA48.12..] 24-690 Vrms [RA60.16..]	3-60 VDC [RD0605..D] 3-200 VDC [RD2001..D] 3-350 VDC [RD3501..D]	24-440 Vrms [RZ3A40..] 42-530 Vrms [RZ3A48..] 42-660 Vrms [RZ3A60..]
Blocking voltage	<650 Vp [RA24.06..] <850 Vp [RA44.08..] <1200 Vp [RA48.12..] <1600 Vp [RA60.16..]		<850 Vp [RZ3A40..] <1200 Vp [RZ3A48..] <1600 Vp [RZ3A60..]
Power factor	≥ 0.5		
Operating temperature	-20°C to +70°C	-20°C to +70°C	-30°C to +80°C
Terminals	Screw / 5 way plug	Screw type with clamp	Screw type with clamp
Approvals/Marks	CE - UR - CSA	CE - CSA	CE - UR - CSA
<b>References</b>			
230 Vrms	<b>RA24..-D..</b>	200 VDC: <b>RD2001-D</b>	
	<b>RA24..LA..</b>	350 VDC: <b>RD3501-D</b>	
	<b>RA24..HA..</b>		
400 Vrms	<b>RA44..-D..</b>	60 VDC: <b>RD0605-D</b>	
	<b>RA44..LA..</b>		<b>RZ3A40D..*</b>
	<b>RA44..HA..</b>		<b>RZ3A40A..*</b>
480 Vrms	<b>RA48..-D..</b>		
	<b>RA48..LA..</b>		<b>RZ3A48D..*</b>
	<b>RA48..HA..</b>		<b>RZ3A48A..*</b>
600 Vrms	<b>RA60..-D..</b>		<b>RZ3A60D..*</b>
			<b>RZ3A60A..*</b>

\* Add suffix 'P' for additional integrated Over Temperature Protection

# Solid state relays, 1 / 3-phase

## AC output switching - Hybrid relays for DIN rail mounting

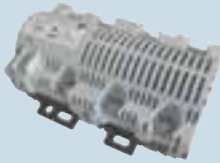
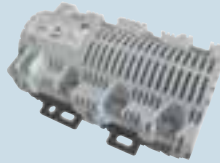
Types	RMD1H 20 AAC	RMD2H 30/40 AAC	RMD3H 30/40 AAC
Hybrid relays. AC operating frequency range 45-65 Hz.			
Dimensions HxWxD (mm)	81 x 17.5 x 67.2	97 x 140.7 x 50.7	97 x 140.7 x 50.7
Features	Hybrid relay	2 pole switching hybrid relay	3 pole switching hybrid relay

### Input specifications

Control input range	4-32 VDC [RMD...D20] 24-275 VAC [RMD...A20]	24 VAC/DC +10/-15% [RMD2..LA..] 120 VAC/DC +10/-15% [RMD2..MA..] 240 VAC/DC +10/-15% [RMD2..HA..]	24 VAC/DC +10/-15% [RMD3..LA..] 120 VAC/DC +10/-15% [RMD3..MA..] 240 VAC/DC +10/-15% [RMD3..HA..]
Max. input current	5 mA [RMD..D20] 3 mA [RMD..A20]	400 mA	400 mA

### Output specifications

Rated operational current			
AC 51 @ Ta=25°C	20 AAC	30 AAC [RMD2..30] 40 AAC [RMD2..40]	30 AAC [RMD3..30] 40 AAC [RMD3..40]
Min. operational current	100 mA	150 mA	150 mA

### General specifications

Operational voltage range	195-253 Vrms	240 VAC -15% /+10% [RMD..24..] 277 VAC -15% /+10% [RMD..48..]	240 VAC -15% /+10% [RMD..24..] 277 VAC -15% /+10% [RMD..48..] 480 VAC + N [RMD..48..]
Power factor	≥ 0.9	≥ 0.9 at rated voltage	≥ 0.9 at rated voltage
Operating temperature	-5°C to +55°C	0°C to 70°C	0°C to 70°C
Terminals	Box clamp	Input 6.35 mm FASTON, Output screw	Input 6.35 mm FASTON, Output screw
Approvals/Marks	CE - cURus	CE - cURus	CE - cURus



### References

	20 AAC	30 AAC	30 AAC
	<b>RMD1H23D20</b>	<b>RMD2H24LA30</b>	<b>RMD3H24LA30</b>
	<b>RMD1H23A20</b>	<b>RMD2H24MA30</b>	<b>RMD3H24MA30</b>
		<b>RMD2H24HA30</b>	<b>RMD3H24HA30</b>
		40 AAC	<b>RMD3H48LA30</b>
		<b>RMD2H24LA40</b>	<b>RMD3H48MA30</b>
		<b>RMD2H24MA40</b>	<b>RMD3H48HA30</b>
		<b>RMD2H24HA40</b>	40 AAC
			<b>RMD3H24LA40</b>
			<b>RMD3H24MA40</b>
			<b>RMD3H24HA40</b>
			<b>RMD3H48LA40</b>
			<b>RMD3H48MA40</b>
			<b>RMD3H48HA40</b>



# Solid state contactors, 1-phase



Ready for use design - DIN rail mounting, AC output switching

Types	RGC/RGH1A..15KKE 20 AAC	RGC1A..25KKE 25 AAC	RGC/RGH1A..30KKE 30 AAC
Single phase, semiconductor contactors with integrated heatsink, LED indication and IP20 protection, AC operating frequency 45-65 Hz, Rated isolation voltage $\geq 4000$ Vrms, 100 kArms Short Circuit Current Rating, Motor ratings according to UL508			
Dimensions HxWxD (mm)	110 x 17.8 x 103.5	110 x 17.8 x 103.5	110 x 22.5 x 141
Features	17.8 mm wide solid state contactor, integrated output varistor, DC or AC control voltage, screw terminals for power and control, E-type layout	17.8 mm wide solid state contactor, integrated output varistor, DC or AC control voltage, screw terminals for power and control, E-type layout	22.5 mm wide solid state contactor, integrated output varistor, DC or AC control voltage, screw terminals for power and control, E-type layout
<b>Input specifications</b>			
Input Specifications	3-32 VDC [RG.23D.] 4-32 VDC [RG.60D.] 20-275 VAC, 24-190 VDC [RG..A.]	3-32 VDC [RG.23D.] 4-32 VDC [RG.60D.] 20-275 VAC, 24-190 VDC [RG..A.]	3-32 VDC [RG.23D.] 4-32 VDC [RG.60D.] 20-275 VAC, 24-190 VDC [RG..A.]
Max. input current	11 mADC [RG..D.] 30 mAAC [RG..A.]	11 mADC [RG..D.] 30 mAAC [RG..A.]	11 mADC [RG..D.] 30 mAAC [RG..A.]
<b>Output specifications</b>			
Rated operational current AC 51 @ $T_a=40^\circ\text{C}$	20 AAC	25 AAC	30 AAC
AC 53a @ $T_a=40^\circ\text{C}$	5 AAC	5 AAC	8 AAC [RGC..30.] 10 AAC [RGH..31.]
Min. operational current	150 mA [RGC..15.] 400 mA [RGH..15.]	250 mA	250 mA [RGC..30.] 400 mA [RGH..31.]
Non rep. surge current ( $t=10$ ms)	325 Ap [RGC..15.] 1150 Ap [RGH..15.]	600 Ap	600 Ap [RGC..30.] 1150 Ap [RGH..31.]
Off-state leakage current	3 mAAC	3 mAAC	3 mAAC
$I^2t$ for fusing ( $t=10$ ms)	525 A <sup>2</sup> s [RGC..15.] 6600 A <sup>2</sup> s [RGH..15.]	1800 A <sup>2</sup> s	1800 A <sup>2</sup> s [RGC..30.] 6600 A <sup>2</sup> s [RGH..31.]
Critical $dV/dt$ (@ $T_j$ init= $40^\circ\text{C}$ )	1000 V/ $\mu\text{s}$	1000 V/ $\mu\text{s}$	1000 V/ $\mu\text{s}$
<b>General specifications</b>			
Operational voltage range	24-240 VAC +10% [RG.23..] 42-600 VAC +10% [RG.60..]	24-240 VAC +10% [RG.23..] 42-600 VAC +10% [RG.60..]	24-240 VAC +10% [RG.23..] 42-600 VAC +10% [RG.60..]
Blocking voltage	800 Vp [RGC.23.] 1200 Vp [RGC.60.] 1600 Vp [RGH.60.]	800 Vp [RGC.23.] 1200 Vp [RGC.60.]	800 Vp [RGC.23.] 1200 Vp [RGC.60.] 1600 Vp [RGH.60.]
Power factor	$\geq 0.5$ at rated voltage	$\geq 0.5$ at rated voltage	$\geq 0.5$ at rated voltage
Operating temperature	-40°C to +80°C	-40°C to +80°C	-40°C to +80°C
Approvals/Marks	CE - cULus - VDE - GL [RGC..15.]	CE - cULus - VDE - GL	CE - cULus - VDE - GL [RGC..30.]
<b>References</b>			
DC control voltage			
230 VAC, 800 Vp	RGC1A23D15KKE	RGC1A23D25KKE	RGC1A23D30KKE
600 VAC, 1200 Vp	RGC1A60D15KKE	RGC1A60D25KKE	RGC1A60D30KKE
600 VAC, 1600 Vp, 6600 A <sup>2</sup> s	RGH1A60D15KKE		RGH1A60D31KKE
AC/DC control voltage			
230 VAC, 800 Vp	RGC1A23A15KKE	RGC1A23A25KKE	RGC1A23A30KKE
600 VAC, 1200 Vp	RGC1A60A15KKE	RGC1A60A25KKE	RGC1A60A30KKE
600 VAC, 1600 Vp, 6600 A <sup>2</sup> s	RGH1A60A15KKE		RGH1A60A31KKE

Instant On (Random) Switching available on request (RGC1B60D...)

# Solid state contactors, 1-phase

Ready for use design - DIN rail mounting, AC output switching

Types	RGC/RGH1A..15MKE 20 AAC	RGC1A..25MKE 25 AAC	RGC/RGH1A..30MKE 30 AAC
Single phase, semiconductor contactors with integrated heatsink, LED indication and IP20 protection, AC operating frequency 45-65 Hz, Rated isolation voltage $\geq 4000$ Vrms, 100 kArms Short Circuit Current Rating, Motor ratings according to UL508			
Dimensions HxWxD (mm)	110 x 17.8 x 114.5	110 x 17.8 x 114.5	110 x 22.5 x 152
Features	17.8 mm wide solid state contactor, integrated varistor for overvoltage protection, DC or AC control voltage range, screw terminals with captivated clamp for power terminals and spring plug for control, E-type layout	17.8 mm wide solid state contactor, integrated varistor for overvoltage protection, DC or AC control voltage range, screw terminals with captivated clamp for power terminals and spring plug for control, E-type layout	22.5 mm wide solid state contactor, integrated varistor for overvoltage protection, DC or AC control voltage range, screw terminals with captivated clamp for power terminals and spring plug for control, E-type layout

## Input specifications

Control input range	3-32 VDC [RG.23D.] / 4-32 VDC [RG.60D.] 20-275 VAC, 24-190 VDC [RG..A.]	3-32 VDC [RG.23D.] / 4-32 VDC [RG.60D.] 20-275 VAC, 24-190 VDC [RG..A.]	3-32 VDC [RG.23D.] / 4-32 VDC [RG.60D.] 20-275 VAC, 24-190 VDC [RG..A.]
Max. input current	11 mADC [RG..D.] 30 mAAC [RG..A.]	11 mADC [RG..D.] 30 mAAC [RG..A.]	11 mADC [RG..D.] 30 mAAC [RG..A.]

## Output specifications

Rated operational current			
AC 51 @ Ta=40°C	20 AAC	25 AAC	30 AAC
AC 53a @ Ta=40°C	5 AAC	5 AAC	8 AAC [RGC..30.] 10 AAC [RGH..31.]
Min. operational current	150 mA [RGC..15.] 400 mA [RGH..15.]	250 mA	250 mA [RGC..30.] 400 mA [RGH..31.]
Non rep. surge current (t=10 ms)	325 Ap [RGC...15..] 1150 Ap [RGH...15..]	600 Ap	600 Ap [RGC..30.] 1150 Ap [RGH..31.]
Off-state leakage current	3 mAAC	3 mAAC	3 mAAC
I <sup>2</sup> t for fusing (t=10 ms)	525 A <sup>2</sup> s [RGC..15.] 6600 A <sup>2</sup> s [RGH..15.]	1800 A <sup>2</sup> s	1800 A <sup>2</sup> s [RGC..30.] 6600 A <sup>2</sup> s [RGH..31.]
Critical dV/dt (@Tj init=40°C)	1000 V/μs	1000 V/μs	1000 V/μs

## General specifications

Operational voltage range	24-240 VAC +10% [RG.23..] 42-600 VAC +10% [RG.60..]	24-240 VAC +10% [RG.23..] 42-600 VAC +10% [RG.60..]	24-240 VAC +10% [RG.23..] 42-600 VAC +10% [RG.60..]
Blocking voltage	800 Vp [RGC.23.] 1200 Vp [RGC.60.] 1600 Vp [RGH.60.]	800 Vp [RGC.23.] 1200 Vp [RGC.60.]	800 Vp [RGC.23.] 1200 Vp [RGC.60.] 1600 Vp [RGH.60.]
Power factor	$\geq 0.5$ at rated voltage	$\geq 0.5$ at rated voltage	$\geq 0.5$ at rated voltage
Operating temperature	-40°C to +80°C	-40°C to +80°C	-40°C to +80°C
Approvals/Marks	CE - cULus - VDE - GL [RGC..15.]	CE - cULus - VDE - GL	CE - cULus - VDE - GL [RGC..30.]



## References

DC control voltage			
230 VAC, 800 Vp	RGC1A23D15MKE	RGC1A23D25MKE	RGC1A23D30MKE
600 VAC, 1200 Vp	RGC1A60D15MKE	RGC1A60D25MKE	RGC1A60D30MKE
600 VAC, 1600 Vp, 6600 A <sup>2</sup> s	RGH1A60D15MKE		RGH1A60D31MKE
AC/DC control voltage			
230 VAC, 800 Vp	RGC1A23A15MKE	RGC1A23A25MKE	RGC1A23A30MKE
600 VAC, 1200 Vp	RGC1A60A15MKE	RGC1A60A25MKE	RGC1A60A30MKE
600 VAC, 1600 Vp, 6600 A <sup>2</sup> s	RGH1A60A15MKE		RGH1A60A31MKE

Instant On (Random) Switching available on request (RGC1B60D...)

# Solid state contactors, 1-phase

Ready for use design - DIN rail mounting, AC output switching

Types	RGC1A..15KGU 20 AAC	RGC1A..25KGU 25 AAC	RGC1A..30KGU 30 AAC
Single phase, semiconductor contactors with integrated heatsink, LED indication and IP20 protection, AC operating frequency 45-65 Hz, Rated isolation voltage $\geq$ 4000 Vrms, 100 kArms Short Circuit Current Rating, Motor ratings according to UL508			
Dimensions HxWxD (mm)	110 x 17.8 x 103.5	110 x 17.8 x 103.5	110 x 22.5 x 141
Features	17.8 mm wide solid state contactor, integrated varistor for overvoltage protection, DC or AC control voltage range, screw terminals with captivated clamp for connection of control terminals and box clamps for power terminals, U-type layout	17.8 mm wide solid state contactor, integrated varistor for overvoltage protection, DC or AC control voltage range, screw terminals with captivated clamp for connection of control terminals and box clamps for power terminals, U-type layout	22.5 mm wide solid state contactor, integrated varistor for overvoltage protection, DC or AC control voltage range, screw terminals with captivated clamp for connection of control terminals and box clamps for power terminals, U-type layout

## Input specifications

Control input range	3-32 VDC [RG.23D.] 4-32 VDC [RG.60D.] 20-275 VAC, 24-190 VDC [RG..A.]	3-32 VDC [RG.23D.] 4-32 VDC [RG.60D.] 20-275 VAC, 24-190 VDC [RG..A.]	3-32 VDC [RG.23D.] 4-32 VDC [RG.60D.] 20-275 VAC, 24-190 VDC [RG..A.]
Max. input current	11 mADC [RG..D.] 30 mAAC [RG..A.]	11 mADC [RG..D.] 30 mAAC [RG..A.]	11 mADC [RG..D.] 30 mAAC [RG..A.]

## Output specifications

Rated operational current			
AC 51 @ $T_a=40^\circ\text{C}$	20 AAC	25 AAC	30 AAC
AC 53a @ $T_a=40^\circ\text{C}$	5 AAC	5 AAC	8 AAC
Min. operational current	150 mA	250 mA	250 mA
Non rep. surge current (t=10 ms)	325 Ap	600 Ap	600 Ap
Off-state leakage current	3 mAAC	3 mAAC	3 mAAC
I <sup>t</sup> for fusing (t=10 ms)	525 A <sup>2</sup> s	1800 A <sup>2</sup> s	1800 A <sup>2</sup> s
Critical dV/dt (@ $T_j$ init = 40°C)	1000 V/ $\mu$ s	1000 V/ $\mu$ s	1000 V/ $\mu$ s

## General specifications

Operational voltage range	24-240 VAC +10% [RG.23..] 42-600 VAC +10% [RG.60..]	24-240 VAC +10% [RG.23..] 42-600 VAC +10% [RG.60..]	24-240 VAC +10% [RG.23..] 42-600 VAC +10% [RG.60..]
Blocking voltage	800 V <sub>P</sub> [RGC.23.] 1200 V <sub>P</sub> [RGC.60.]	800 V <sub>P</sub> [RGC.23.] 1200 V <sub>P</sub> [RGC.60.]	800 V <sub>P</sub> [RGC.23.] 1200 V <sub>P</sub> [RGC.60.]
Power factor	$\geq$ 0.5 at rated voltage	$\geq$ 0.5 at rated voltage	$\geq$ 0.5 at rated voltage
Operating temperature	-40°C to +80°C	-40°C to +80°C	-40°C to +80°C
Approvals/Marks	CE - cULus - VDE - GL	CE - cULus - VDE - GL	CE - cULus - VDE - GL

## References

DC control voltage			
230 VAC, 800 V <sub>P</sub>	RGC1A23D15KGU	RGC1A23D25KGU	RGC1A23D30KGU
600 VAC, 1200 V <sub>P</sub>	RGC1A60D15KGU	RGC1A60D25KGU	RGC1A60D30KGU
AC/DC control voltage			
230 VAC, 800 V <sub>P</sub>	RGC1A23A15KGU	RGC1A23A25KGU	RGC1A23A30KGU
600 VAC, 1200 V <sub>P</sub>	RGC1A60A15KGU	RGC1A60A20KGU	RGC1A60A30KGU

Instant On (Random) Switching available on request (RGC1B60D...)

# Solid state contactors, 1-phase

Ready for use design - DIN rail mounting, AC output switching

Types	RG..40/41/42KGE 40/43 AAC	RG..40/41/42MGE 40/43 AAC	RG..60/62KGE 60/65 AAC	RGC1A..62MGE 65 AAC
Single phase, semiconductor contactors with integrated heatsink, LED indication and IP20 protection, AC operating frequency 45-65 Hz, Rated isolation voltage $\geq 4000$ Vrms, 100 kArms Short Circuit Current Rating, Motor ratings according to UL508				

Dimensions HxWxD (mm)	110 x 35.6 x 141	110 x 35.6 x 152	110 x 69.1 x 141	110 x 69.1 x 152
Features	35 mm wide solid state contactor, integrated varistor, DC or AC control voltage, screw terminals for control, box clamp for power terminals, E-type layout	35 mm wide solid state contactor, integrated varistor, DC or AC control voltage, spring plug for control, box clamp for power terminals, E-type layout	70 mm wide solid state contactor, integrated varistor, DC or AC control voltage, screw terminals for control, box clamp for power terminals, E-type layout	70 mm wide solid state contactor, integrated varistor, DC or AC control voltage, spring plug for control, box clamp for power terminals, E-type layout

## Input specifications

Control input range	3-32 VDC [RG..23D..] 4-32 VDC [RG..60D..] 20-275 VAC, 24-190 VDC [RG..A..]	3-32 VDC [RG..23D..] 4-32 VDC [RG..60D..] 20-275 VAC, 24-190 VDC [RG..A..]	3-32 VDC [RG..23D..] 4-32 VDC [RG..60D..] 20-275 VAC, 24-190 VDC [RG..A..]	3-32 VDC [RG..23D..] 4-32 VDC [RG..60D..] 20-275 VAC, 24-190 VDC [RG..A..]
Max. input current	11 mADC [RG..D..] 30 mAAC [RG..A..]	11 mADC [RG..D..] 30 mAAC [RG..A..]	11 mADC [RG..D..] 30 mAAC [RG..A..]	11 mADC [RG..D..] 30 mAAC [RG..A..]

## Output specifications

Rated operational current AC 51 @ Ta=40°C	40 / 43 AAC [RGC..40/42], 40 AAC [RGH..40/41]	40 / 43 AAC [RGC..40/42], 40 AAC [RGH..41]	60 / 65 AAC [RGC..60/62], 65 AAC [RGH..60]	65 AAC [RGC..62]
AC 53a @ Ta=40°C	13 / 16 AAC [RGC..40/42], 10 / 13 AAC [RGH..40/41]	13 / 16 AAC [RGC..40/42], 13 AAC [RGH..41]	14.8 / 20 AAC [RGC..60/62], 18 AAC [RGH..60]	20 AAC [RGC..62]
Min. operational current	400 / 500 mAAC [RGC..40/42], 250 / 400 mAAC [RGH..40/41]	400 / 500 mAAC [RGC..40/42], 400 mAAC [RGH..41]	400 / 500 mAAC [RGC..60/62], 400 mAAC [RGH..60]	500 mAAC [RGC..62]
Non rep. surge current (t=10 ms)	800 / 1900 Ap [RGC..40/42], 600 / 1150 Ap [RGH..40/41]	800 / 1900 Ap [RGC..40/42], 1150 Ap [RGH..41]	800 / 1900 Ap [RGC..60/62], 1150 Ap [RGH..60]	1900 Ap [RGC..62]
Off-state leakage current	3 mAAC	3 mAAC	3 mAAC	3 mAAC
I²t for fusing (t=10 ms)	3200 / 18000 A²s [RGC..40/42], 1800 / 6600 A²s [RGH..40/41]	3200 / 18000 A²s [RGC..40/42], 6600 A²s [RGH..41]	3200 / 18000 A²s [RGC..60/62], 6600 A²s [RGH..60]	18000 A²s [RGC..62]
Critical dV/dt (@Tj init=40°C)	1000 V/µs	1000 V/µs	1000 V/µs	1000 V/µs

## General specifications

Operational voltage range	24-240 VAC +10% [RG..23..] 42-600 VAC +10% [RG..60..]	24-240 VAC +10% [RG..23..] 42-600 VAC +10% [RG..60..]	24-240 VAC +10% [RG..23..] 42-600 VAC +10% [RG..60..]	24-240 VAC +10% [RG..23..] 42-600 VAC +10% [RG..60..]
Blocking voltage	800 Vp [RGC..23..] 1200 Vp [RGC..60..] 1600 Vp [RGH..60..]	800 Vp [RGC..23..] 1200 Vp [RGC..60..] 1600 Vp [RGH..60..]	800 Vp [RGC..23..] 1200 Vp [RGC..60..] 1600 Vp [RGH..60..]	800 Vp [RGC..23..] 1200 Vp [RGC..60..]
Power factor	$\geq 0.5$ at rated voltage	$\geq 0.5$ at rated voltage	$\geq 0.5$ at rated voltage	$\geq 0.5$ at rated voltage
Operating temperature	-40°C to +80°C	-40°C to +80°C	-40°C to +80°C	-40°C to +80°C
Approvals/Marks	CE - cULus - VDE	CE - cULus - VDE	CE - cULus - VDE	CE - cULus - VDE

## References



230 VAC, 800 Vp, 3200 A's	40 AAC: RGC1A23X40KGE	40 AAC: RGC1A23X40MGE	60 AAC: RGC1A23X60KGE	
230 VAC, 800 Vp, 18000 A's	43 AAC: RGC1A23X42KGE	43 AAC: RGC1A23X42MGE	65 AAC: RGC1A23X62KGE	65 AAC: RGC1A23X62MGE
600 VAC, 1200 Vp, 3200 A's	40 AAC: RGC1A60X40KGE	40 AAC: RGC1A60X40MGE	60 AAC: RGC1A60X60KGE	
600 VAC, 1200 Vp, 18000 A's	43 AAC: RGC1A60X42KGE	43 AAC: RGC1A60X42MGE	65 AAC: RGC1A60X62KGE	65 AAC: RGC1A60X62MGE
600 VAC, 1600 Vp, 1800 A's	40 AAC: RGH1A60X40KGE			
600 VAC, 1600 Vp, 6600 A's	40 AAC: RGH1A60X41KGE	40 AAC: RGH1A60X41MGE	65 AAC: RGH1A60X60KGE	

X must be replaced with D for DC control 3-32 VDC, 4-32 VDC (for 600 VAC versions)  
X must be replaced with A for AC control 20-275 VAC, 24-190 VDC  
RGC1B.. models for Instant On (Random) switching are available on request

CARLO GAVAZZI Automation Components. Specifications are subject to change without notice. Illustrations are for example only.

# Solid state contactors, 1-phase

Ready for use design - DIN rail mounting

	AC output switching		DC output switching
Types	<b>RG..40/42KGU</b> 40/43 AAC	<b>RG..60/62KGU</b> 60/65 AAC	<b>RGCTD1000D15KKE</b> 15 ADC
Single phase, semiconductor contactors with integrated heatsink, LED indication and IP20 protection, Rated isolation voltage $\geq$ 4000 Vrms, 100 kArms short circuit current rating and Motor ratings according to UL508 for AC Output Switching			
Dimensions HxWxD (mm)	110 x 35.6 x 141	110 x 69.1 x 141	110 x 17.8 x 141
Features	35 mm wide solid state contactor, integrated varistor, DC or AC control voltage, screw terminals for control, box clamp for power terminals, U-type layout	70 mm wide solid state contactor, integrated varistor, DC or AC control voltage, screw terminals for control, box clamp for power terminals, U-type layout	17.8 mm wide solid state contactor for DC switching with integrated free wheeling diode, DC control, screw terminals for power and control, E-type layout
<b>Input specifications</b>			
Control input range	3-32 VDC [RG..23D..] 4-32 VDC [RG..60D..] 20-275 VAC, 24-190 VDC [RG..A..]	3-32 VDC [RG..23D..] 4-32 VDC [RG..60D..] 20-275 VAC, 24-190 VDC [RG..A..]	4.5-32 VDC
Max. input current	11 mADC [RG..D..] 30 mAAC [RG..A..]	11 mADC [RG..D..] 30 mAAC [RG..A..]	13.7 mADC
<b>Output specifications</b>			
Rated operational current			
AC-51 @ Ta = 40°C	40/43 AAC [RGC..40/42] 40 AAC [RGH..41]	60 / 65 AAC [RGC..60/62], 65 AAC [RGH..60]	
AC-53a @ Ta = 40°C	13/16 AAC [RGC..40/42] 13 AAC [RGH..41]	14.8 / 20 AAC [RGC..60/62], 18 AAC [RGH..60]	
DC 1 @ 60°C			8 ADC
Min. operational current	400 / 500 mAAC [RGC..40/42], 400 mAAC [RGH..41]	400 / 500 mAAC [RGC..60/62], 400 mAAC [RGH..60]	20 mADC
Non rep. surge current (t=10 ms)	800 / 1900 Ap [RGC..40/42], 1150 Ap [RGH..41]	800 / 1900 Ap [RGC..60/62], 1150 Ap [RGH..60]	200 ADC (10us)
Off-state leakage current	3 mAAC	3 mAAC	3 mAAC
I <sup>2</sup> t for fusing (t=10 ms)	3200 / 18000 A <sup>2</sup> s [RGC..40/42], 6600 A <sup>2</sup> s [RGH..41]	3200 / 18000 A <sup>2</sup> s [RGC..60/62], 6600 A <sup>2</sup> s [RGH..60]	1.5 mADC
Critical dV/dt (@ Tj init= 40°C)	1000 V/μs	1000 V/μs	1000 V/μs
<b>General specifications</b>			
Operational voltage range	24-240 VAC +10% [RG..23..] 42-600 VAC +10% [RG..60..]	24-240 VAC +10% [RG..23..] 42-600 VAC +10% [RG..60..]	24-1000 VDC [CE] 24-600 VDC [UL508]
Blocking voltage	800 Vp [RGC..23..] 1200 Vp [RGC..60..] 1600 Vp [RGH..60..]	800 Vp [RGC..23..] 1200 Vp [RGC..60..] 1600 Vp [RGH..60..]	1200 Vp
Power factor	$\geq$ 0.5 at rated voltage	$\geq$ 0.5 at rated voltage	
Operating temperature	-40°C to +80°C	-40°C to +80°C	-40°C to +80°C
Approvals/Marks	CE - cULus - VDE	CE - cULus - VDE	CE - cULus
<b>References</b>			
230 VAC, 800 Vp, 3200 A's	40 AAC: <b>RGCTA23X40KGU</b>	60 AAC: <b>RGCTA23X60KGU</b>	
230 VAC, 800 Vp, 18000 A's	43 AAC: <b>RGCTA23X42KGU</b>	65 AAC: <b>RGCTA23X62KGU</b>	
600 VAC, 1200 Vp, 3200 A's	40 AAC: <b>RGCTA60X40KGU</b>	60 AAC: <b>RGCTA60X60KGU</b>	
600 VAC, 1200 Vp, 18000 A's	43 AAC: <b>RGCTA60X42KGU</b>	65 AAC: <b>RGCTA60X62KGU</b>	
600 VAC, 1600 Vp, 6600 A's	40 AAC: <b>RGHTA60X41KGU</b>	65 AAC: <b>RGHTA60X60KGU</b>	
1000 VDC			15 ADC: <b>RGCTD1000D15KKE</b>

X must be replaced with D for DC control 3-32 VDC, 4-32 VDC (for 600 VAC versions). X must be replaced with A for AC control 20-275 VAC, 24-190 VDC  
 RGC1B.. models for Instant On (Random) switching are available on request

# Solid state contactors, 1-phase

Ready for use design - DIN rail mounting  
AC output switching with integrated over temperature protection

Types	RGCI A..25GKEP 25 AAC	RGCI A..30GKEP 30 AAC	RGCI A..40/42GG.P 40/43 AAC
Single phase, semiconductor contactors with integrated heatsink, LED indication and IP 20 protection, AC operating frequency 45-65 Hz, Rated isolation voltage $\geq 4000$ Vrms, 100 kArms Short Circuit Current Rating, Motor ratings according to UL508			

Dimensions HxWxD (mm)	110 x 22.5 x 130	110 x 22.5 x 168	110x 35.6 x 168
Features	22.5 mm wide solid state contactor, integrated varistor for overvoltage protection and integrated over temperature for protection against over heating, screw terminals with captivated clamp for connection of power terminals and box clamps for control terminals	22.5 mm wide solid state contactor, integrated varistor for overvoltage protection and integrated over temperature for protection against over heating, screw terminals with captivated clamp for connection of power terminals and box clamps for control terminals	35 mm wide solid state contactor, integrated varistor for overvoltage protection and integrated over temperature for protection against over heating, box clamps for connection of power and control terminals

## Input specifications

Control input range	5-32 VDC [RG.D.] 20-275 VAC, 24-190 VDC [RG..A.]	5-32 VDC [RG.D.] 20-275 VAC, 24-190 VDC [RG..A.]	5-32 VDC [RG.D.] 20-275 VAC, 24-190 VDC [RG..A.]
Max. input current	24 mADC [RG..D.] 35 mAAC [RG..A.]	24 mADC [RG..D.] 35 mAAC [RG..A.]	24 mADC [RG..D.] 35 mAAC [RG..A.]

## Supply voltage

Rated supply voltage	24 VDC -15%, +20%	24 VDC -15%, +20%	24 VDC -15%, +20%
Max. current rating	50 mADC	50 mADC	50 mADC

## Over temperature alarm

Alarm output	PNP open collector normally closed, max. 24 VDC / 50 mA [RGC.D.P] Potential free normally closed, max. 24 VDC / 50 mA [RGC.A.P]	PNP open collector normally closed, max. 24 VDC / 50 mA [RGC.D.P] Potential free normally closed, max. 24 VDC / 50 mA [RGC.A.P]	PNP open collector normally closed, max. 24 VDC / 50 mA [RGC.D.P] Potential free normally closed, max. 24 VDC / 50 mA [RGC.A.P]
--------------	--	--	--

## Output specifications

Rated operational current			
AC 51 @ Ta=40°C	25 AAC	30 AAC	40 AAC [RGC..40], 43 AAC [RGC..42]
AC 53a @ Ta=40°C	5 AAC	8 AAC	13 AAC [RGC..40], 16 AAC [RGC..42]
Min. operational current	250 mA	250 mA	400 mAAC [RGC..40], 500 mAAC [RGC..42]
Non rep. surge current (t=10 ms)	600 Ap	600 Ap	800 Ap [RGC.40] 1900 Ap [RGC..42]
Off-state leakage current	3 mAAC	3 mAAC	3 mAAC
I <sup>2</sup> t for fusing (t=10 ms)	1800 A <sup>2</sup> s	1800 A <sup>2</sup> s	3200 A <sup>2</sup> s [RGC..40], 18000 A <sup>2</sup> s [RGC..42]
Critical dV/dt off-state (@ Tj init = 40°C)	1000 V/μs	1000 V/μs	1000 V/μs

## General specifications

Operational voltage range	24-240 VAC +10% [RG.23..] 42-600 VAC +10% [RG.60..]	24-240 VAC +10% [RG.23..] 42-600 VAC +10% [RG.60..]	24-240 VAC +10% [RG.23..] 42-600 VAC +10% [RG.60..]
Blocking voltage	800 Vp [RGC.23.] 1200 Vp [RGC.60.]	800 Vp [RGC.23.] 1200 Vp [RGC.60.]	1200 Vp
Power factor	$\geq 0.5$ at rated voltage	$\geq 0.5$ at rated voltage	$\geq 0.5$ at rated voltage
Operating temperature	-40°C to +70°C	-40°C to +70°C	-40°C to +70°C
Approvals/Marks	CE - cULus - VDE	CE - cULus - VDE	CE - cULus - VDE

## References

DC control voltage			
230 VAC, 800 Vp		30 AAC: RGC1A23D30GKEP	
600 VAC, 1200 Vp	25 AAC: RGC1A60D25GKEP	30 AAC: RGC1A60D30GKEP	40 AAC: RGC1A60D40GGXP
600 VAC, 1200 Vp, high I <sup>2</sup> t			43 AAC: RGC1A60D42GGXP
AC/DC control voltage			
600 VAC, 1200 Vp	25 AAC: RGC1A60A25GKEP	30 AAC: RGC1A60A30GKEP	40 AAC: RGC1A60A40GGXP
600 VAC, 1200 Vp, high I <sup>2</sup> t			43 AAC: RGC1A60A42GGXP



X must be replaced with the following depending on the connection configuration required  
Configuration X: E = E-type U = U-type

# Solid state contactors, 1-phase

Ready for use design - DIN rail mounting, AC output switching

Integrated over temperature protection

Integrated fuse

Types	RGC1A..60/62GG.P 60/65 AAC	RGC1A..90/92GG.P 85 AAC	RGC1F 20/30/40 AAC
Single phase, semiconductor contactors with integrated heatsink, LED indication and IP20 protection, AC operating frequency 45-65Hz, Rated isolation voltage ≥4000Vrms, 100kArms Short Circuit Current Rating, Motor ratings according to UL508			
Dimensions HxWxD (mm)	110 x 69.1 x 168	126 x 69.1 x 168 (with fan)	110 x 35.6 x 168
Features	70 mm wide solid state contactor, integrated varistor for overvoltage protection and integrated over temperature for protection against over heating, box clamps for connection of power & control terminals	70 mm wide solid state contactor with attached fan, integrated varistor for overvoltage protection and integrated over temperature for protection against over heating, box clamps for connection of power & control terminals	35 mm wide solid state contactor with integrated fuse, additional monitoring features available with RGC1FS.. for SSR, load & fuse failure detection, integrated varistor for overvoltage protection, DC control voltage range, box clamps for connection of power & control terminals

## Input specifications

Control input range	5-32 VDC [RG.D.] 20-275 VAC, 24-190 VDC [RG..A.]	5-32 VDC [RG.D.] 20-275 VAC, 24-190 VDC [RG..A.]	3-32 VDC [RGC1F..23.] 4.5-32 VDC [RGC1F..60.]
Max. input current	23 mA DC [RG..D.]/35 mA AC [RG..A.]	23 mA DC [RG..D.]/ 35 mA AC [RG..A.]	12 mA DC

## Supply voltage

Rated supply voltage	24 VDC -15%, +20%	24 VDC -15%, +20%	24 VDC -15%, +20%
Max. current rating	50 mA DC	50 mA DC (fan rating 24 VDC / 50 mA)	80 mA DC

## Over temperature alarm

Alarm output	PNP open collector normally closed, max. 24 VDC / 50 mA [RGC.D.P] Potential free normally closed, max. 24 VDC / 50 mA [RGC.A.P]	PNP open collector normally closed, max. 24 VDC / 50 mA [RGC.D.P] Potential free normally closed, max. 24 VDC / 50 mA [RGC.A.P]	PNP open collector normally closed, max. 24 VDC / 50 mA [RGC1FS..]
--------------	--	--	--

## Output specifications

Rated operational current			
AC 51 @ Ta=40°C	60 AAC [RGC..60] 65 AAC [RGC..62]	85 AAC	20 AAC [RGC1F..20.]/30 AAC [RGC1F..30.]/40 AAC [RGC1F..40.]
AC 53a @ Ta=40°C	14.8 AAC [RGC..60] 20 AAC [RGC..62]	18 AAC [RGC..90] 20 AAC [RGC..92]	4.7 AAC [RGC1F..20.]/6 AAC [RGC1F..30.] / 8 AAC [RGC1F..40.]
Min. operational current	400 mA [RGC..60] 500 mA [RGC..62]	400 mA [RGC..90] 500 mA [RGC..92]	200 mA
Non rep. surge current (Itsm) (t=10 ms)	800 Ap [RGC..60] 1900 Ap [RGC..62]	1150 Ap [RGC..90] 1900 Ap [RGC..92]	Integrated fuse
Off-state leakage current	3 mA AC	3 mA AC	
I <sup>2</sup> t for fusing (t=10 ms)	3200 A <sup>2</sup> s [RGC..60] 18000 A <sup>2</sup> s [RGC..62]	6600 A <sup>2</sup> s [RGC..90] 18000 A <sup>2</sup> s [RGC..92]	Fuse - 740A <sup>2</sup> s [RGC1F..20.] Fuse - 1400A <sup>2</sup> s [RGC1F..30.] Fuse - 3100A <sup>2</sup> s [RGC1F..40.]
Critical dV/dt off-state (@ Tj init = 40°C)	1000 V/μs	1000 V/μs	1000 V/μs

## General specifications

Operational voltage range	42-600 VAC +10% [RG.60..]	24-240 VAC +10% [RG.23..] 42-600 VAC +10% [RG.60..]	24-240 VAC +10% [RG.23..] 42-600 VAC +10% [RG.60..]
Blocking voltage	1200 Vp	800 Vp [RGC.23.]/1200 Vp [RGC.60.]	1200 Vp
Power factor	≥ 0.5 at rated voltage	≥ 0.5 at rated voltage	≥ 0.5 at rated voltage
Operating temperature	-40°C to +70°C	-40°C to +70°C	-40°C to +70°C
Approvals/Marks	CE - cULus - VDE	CE - cULus - VDE	CE - cULus (up to 30 AAC)

## References



DC control voltage		85 AAC: RGC1A23D90GGXP	20 AAC: RGC1FY23D20GGE 30 AAC: RGC1FY23D30GGE 40 AAC: RGC1FY23D40GGE
230 VAC, 800 Vp			
600 VAC, 1200 Vp	60 AAC: RGC1A60D60GGXP 65 AAC: RGC1A60D62GGXP	85 AAC: RGC1A60D90GGXP 85 AAC: RGC1A60D92GGXP	20 AAC: RGC1FY60D20GGE 30 AAC: RGC1FY60D30GGE 40 AAC: RGC1FY60D40GGE
AC/DC control voltage			
600 VAC, 1200 Vp	60 AAC: RGC1A60A60GGXP 65 AAC: RGC1A60A62GGXP	85 AAC: RGC1A60A90GGXP 85 AAC: RGC1A60A92GGXP	

X and Y must be replaced with the following depending on the version required  
 Configuration X: E = E-type U = U-type  
 Version Y: A = Fuse only S = Fuse + monitoring

CARLO GAVAZZI Automation Components. Specifications are subject to change without notice. Illustrations are for example only.

# Solid state contactors, 1-phase

Ready for use design - AC output switching, integrated current measurement

Types	RGC1S..20/30/31GKEP 23/30 AAC	RGC1S..25GKEP 25 AAC	RGC1S..26GGEP 25 AAC
Single phase, semiconductor contactors with integrated current measurement, E-type configuration, LED indication and IP20 protection, AC operating frequency 45-65 Hz, Rated isolation voltage $\geq 4000$ Vrms, 100 kArms Short Circuit Current Rating			
Dimensions HxWxD (mm)	110 x 22.5 x 163	110 x 22.5 x 126	110 x 22.5 x 126
Features	22.5 mm wide solid state contactor, integrated varistor, DC control, local or remote TEACH, detection of partial load failure (1/6), SSR and load malfunction, SSR overheat protection	22.5 mm wide solid state contactor, integrated varistor, DC control, local or remote TEACH, detection of partial load failure (1/6), SSR and load malfunction, SSR overheat protection	22.5 mm wide solid state contactor, integrated varistor, DC control, local or remote TEACH, detection of partial load failure (1/6), SSR and load malfunction, SSR overheat protection

## Input specifications

Control input range	4-32 VDC	4-32 VDC	4-32 VDC
Max. input current	10 mADC at 24 VDC	10 mADC at 24 VDC	10 mADC at 24 VDC

## Supply voltage

Rated supply voltage	24 VDC -15%, +20%	24 VDC -15%, +20%	24 VDC -15%, +20%
Max. current rating	50 mADC	50 mADC	50 mADC

## Alarm specifications

Output type	NC PNP open collector max. 35 VDC/50 mA	NC PNP open collector max. 35 VDC/50 mA	NC PNP open collector max. 35 VDC/50 mA
Alarm Indication	Red LED (flash rate)	Red LED (flash rate)	Red LED (flash rate)

## Output specifications

Rated operational current			
AC 51 @ Ta=40°C	23 AAC [RGC1S..20] 30 AAC [RGC1S..30] 30 AAC [RGC1S..31]	25 AAC	25 AAC
Minimum TEACH / operational current	1.2 AAC	1.2 AAC	1.2 AAC
Minimum partial load current	0.2 AAC	0.2 AAC	0.2 AAC
Detectable partial load failure	>16.67% from current setpoint	>16.67% from current setpoint	>16.67% from current setpoint
Non. rep. surge current I <sub>tsm</sub> (t=10ms)	325 A <sub>p</sub> [RGC1S..20] 600 A <sub>p</sub> [RGC1S..30] 1150 A <sub>p</sub> [RGC1S..31]	600 A <sub>p</sub>	1900 A <sub>p</sub>
Max. off state leakage current	3 mAAC	3 mAAC	3 mAAC
I <sup>2</sup> t for fusing (t=10ms)	525 A <sup>2</sup> s [RGC1S..20] 1800 A <sup>2</sup> s [RGC1S..30] 6600 A <sup>2</sup> s [RGC1S..31]	1800 A <sup>2</sup> s	18000 A <sup>2</sup> s
Critical dV/dt (@ T <sub>j</sub> init = 40°C)	1000 V/μs	1000 V/μs	1000 V/μs

## General specifications

Operational voltage range	42-600 VAC +10%	42-600 VAC +10%	42-600 VAC +10%
Blocking voltage	1200 V <sub>p</sub>	1200 V <sub>p</sub>	1200 V <sub>p</sub>
Power factor	$\geq 0.9$ at rated voltage	$\geq 0.9$ at rated voltage	$\geq 0.9$ at rated voltage
Operating temperature	-25°C to +70°C	-25°C to +70°C	-25°C to +70°C
Approvals/Marks	CE - cULus	CE - cULus	CE - cULus

## References



600 VAC, 1200 V <sub>p</sub> , 525A <sup>2</sup> s	23 AAC: <b>RGC1S60D20GKEP</b>		
600 VAC, 1200 V <sub>p</sub> , 1800A <sup>2</sup> s	30 AAC: <b>RGC1S60D30GKEP</b>	25 AAC: <b>RGC1S60D25GKEP</b>	
600 VAC, 1200 V <sub>p</sub> , 6600A <sup>2</sup> s	30 AAC: <b>RGC1S60D31GKEP</b>		
600 VAC, 1200 V <sub>p</sub> , 18000A <sup>2</sup> s			25 AAC: <b>RGC1S60D26GGEP</b>

GK = screws for control terminals, box clamps for power terminals  
GG = box clamps for control terminals, box clamps for power terminals





# Solid state contactors, 1-phase

Ready for use design - AC output switching,  
integrated current measurement

Types	RGC1S..41GG.P 43 AAC	RGC1S..61GG.P 65 AAC	RGC1S..90GGEP 85 AAC
Single phase, semiconductor contactors with integrated heatsink, LED indication and IP20 protection, AC operating frequency 45-65Hz, Rated isolation voltage $\geq 4000V_{rms}$ , 100kArms Short Circuit Current Rating, Motor ratings according to UL508			
Dimensions HxWxD (mm)	110 x 35.6 x 163	110 x 69.1 x 163	126 x 69.1 x 163 (with fan)
Features	35mm wide solid-state contactor, integrated varistor, DC control, local or remote TEACH, detection of partial load failure (1/6), SSR and load malfunction, SSR overheat protection	70mm wide solid-state contactor, integrated varistor, DC control, local or remote TEACH, detection of partial load failure (1/6), SSR and load malfunction, SSR overheat protection	70mm wide solid-state contactor with, integrated varistor, DC control, local or remote TEACH, detection of partial load failure (1/6), SSR and load malfunction, SSR overheat protection
<b>Input specifications</b>			
Control input range	4-32 VDC	4-32 VDC	4-32 VDC
Max. input current	10 mADC at 24 VDC	10 mADC at 24 VDC	10 mADC at 24 VDC
<b>Supply voltage</b>			
Supply Voltage	24 VDC -15%, +20%	24 VDC -15%, +20%	24 VDC -15%, +20%
Max. current rating	50 mADC	50 mADC	50 mADC (fan rating 24 VDC / 50 mA)
<b>Alarm specifications</b>			
Output type	NC PNP open collector max. 35 VDC / 50 mA	NC PNP open collector max. 35 VDC / 50 mA	NC PNP open collector max. 35 VDC / 50 mA
Alarm Indication	Red LED (flash rate)	Red LED (flash rate)	Red LED (flash rate)
<b>Output specifications</b>			
Rated operational current			
AC 51 @ $T_a=40^\circ C$	43 AAC	65 AAC	85 AAC
Minimum TEACH / operational current	1.2 AAC	5 AAC	5 AAC
Minimum partial load current	0.2 AAC	0.83 AAC	0.83 AAC
Detectable partial load failure	>16.67% from current setpoint	>16.67% from current setpoint	>16.67% from current setpoint
Non. rep. surge current $I_{tsm}$ (t=10ms)	1900 Ap	1900 Ap	1900 Ap
Max. off state leakage current	3 mAAC	3 mAAC	3 mAAC
$I^2t$ for fusing (t=10 ms)	18000 A <sup>2</sup> s	18000 A <sup>2</sup> s	18000 A <sup>2</sup> s
Critical dV/dt (@ $T_j$ init = 40°C)	1000 V/ $\mu$ s	1000 V/ $\mu$ s	1000 V/ $\mu$ s
<b>General specifications</b>			
Operational voltage range	42-600 VAC +10%	42-600 VAC +10%	42-600 VAC +10%
Blocking voltage	1200 V <sub>p</sub>	1200 V <sub>p</sub>	1200 V <sub>p</sub>
Power factor	$\geq 0.9$ at rated voltage	$\geq 0.9$ at rated voltage	$\geq 0.9$ at rated voltage
Operating temperature	-25°C to +70°C	-25°C to +70°C	-25°C to +70°C
Approvals/Marks	CE - cULus	CE - cULus	CE - cULus
<b>References</b>			
600 VAC, 1200 V <sub>p</sub> , E-type	43 AAC: RGC1S60D41GGEP	65 AAC: RGC1S60D61GGEP	85 AAC: RGC1S60D90GGEP
600 VAC, 1200 V <sub>p</sub> , U-type	43 AAC: RGC1S60D41GGUP	65 AAC: RGC1S60D61GGUP	



GG = box clamps for control terminals, box clamps for power terminals

# Solid state contactors, 1-phase

	AC output switching - MODBUS RTU	AC output switching - Proportional control
<b>Types</b>	<b>RJ1P MB</b> 50 AAC	<b>RJ1P</b> 30/50 AAC
Semiconductor contactors with integrated heatsink. AC operating frequency range 45-65 Hz. Rated isolation voltage $\geq 4000$ Vrms		
Dimensions HxWxD (mm)	103 x 45 x 122	103 x 45 x 103
Features	SSR with fieldbus communication interface	Multifunction Phase-angle, Distributed full cycle and Burst control (1s, 3s and 10s)
<b>Control specifications</b>		
Control input range	2-wire Modbus RTU	4-20 mA [RJ1P...I...] 0-10 VDC [RJ1P...V...]
Max. input current		50 mA [RJ1P...I...] 0-1 mA [RJ1P...V...]
Control supply		24 VAC/DC [RJ1P...V...]
Max. input current		23 mA [RJ1P...V...]
<b>Output specifications</b>		
Rated operational current		
AC 51 @ Ta=25°C	50 AACrms	30 AACrms / 50 AACrms [RJ1P..30/50]
AC 53a @ Ta=25°C		
Min. TEACH / operational current	500 mAACrms	150 mArms / 500 mArms [RJ1P..30/50]
Non-repet. surge current (t=10 ms)	1900 A <sub>p</sub>	325 / 1900 A <sub>p</sub> [RJ1P..30/50]
Off-state leakage current	< 3 mArms	< 3 mArms
I <sup>2</sup> t for fusing (t=10 ms)	18000 A <sup>2</sup> s	525 A <sup>2</sup> s / 18000 A <sup>2</sup> s [RJ1P..30/50]
On state voltage drop	1.6 Vrms	1.6 Vrms
Critical dV/dt off-state	1000 V/μs	1000 V/μs
<b>General specifications</b>		
Operational voltage range	90-265 Vrms	90-265 Vrms [RJ1P23..] 200-550 Vrms [RJ1P48..] 410-660 Vrms [RJ1P60..]
Blocking voltage		650 V <sub>p</sub> [RJ1P23..] 1200 V <sub>p</sub> [RJ1P48..] 1200 V <sub>p</sub> [RJ1P60..]
Power factor	$\geq 0.9$	$\geq 0.9$
Operating temperature	-30°C to +70°C	-20°C to +60°C
Terminals	Box clamp	Box clamp
Approvals/Marks	CE - UR - cUR	CE - UR - cUR
<b>References</b>		
1-phase, zero switching	50 A	30 / 50 A
230 VAC	RJ1P23MBT50EBC	30 AAC: RJ1P23V30E
	RJ1P23MBT50ECS	30 AAC: RJ1P23I30E
	RJ1P23MBT50ECV	50 AAC: RJ1P23V50E 50 AAC: RJ1P23I50E
480 VAC	RJ1P48MBT50EBC	30 AAC: RJ1P48V30E
	RJ1P48MBT50ECS	30 AAC: RJ1P48I30E
	RJ1P48MBT50ECV	50 AAC: RJ1P48V50E 50 AAC: RJ1P48I50E
600 VAC	RJ1P60MBT50EBC	30 AAC: RJ1P60V30E
	RJ1P60MBT50ECS	30 AAC: RJ1P60I30E
	RJ1P60MBT50ECV	50 AAC: RJ1P60V50E 50 AAC: RJ1P60I50E

# Solid state contactors, 1-phase





Ready to use design - DIN rail mounting

Types	RN1F Full cycle 30/50 AAC	RN1S Sense 30/50 AAC
Semiconductor contactors with integrated heatsink. AC operating frequency range 45-65 Hz. Rated isolation voltage $\geq 4000$ Vrms		
Dimensions (mm)	120 x 45 x 110 (30 A) 120 x 90 x 110 (50 A)	120 x 45 x 110 (30 A) 120 x 90 x 110 (50 A)
Features	High precision temperature control	High precision economy switching
<b>Control specifications</b>		
Control input range	4-20 mA [RN.F.I.], 0-10 VDC [RN.F.V.]	7-32 VDC
Max. input current	50 mA [RN.F.I.], 0.1 mA [RN.F.V.]	4 mA
Control supply	12-32 VDC / 24 VAC [RN.V.]	20-32 VDC ( $\leq 40$ mA)
Alarm output		PNP : VCC - 2 VDC ( $\leq 100$ mA) / NPN: 2 VDC @ ( $\leq 100$ mA)
<b>Output specifications</b>		
Rated operational current		
AC 51 @ $T_a=30^\circ\text{C}$	30 Arms [RN.F.30] 50 Arms [RN.F.50]	30 Arms [RN1S...30..] 50 Arms [RN1S...50..]
AC 53a @ $T_a=40^\circ\text{C}$		6 Arms [RN1S...30..] 12 Arms [RN1S...50..]
Min. operational current	500 mArms	200 mArms
Non rep. surge current (I <sub>tsm</sub> ) (t=10 ms)	325 A <sub>P</sub> [RN..30] 600 A <sub>P</sub> [RN..50]	325 A <sub>P</sub> [RN.F.30..] 600 A <sub>P</sub> [RN.F.50..]
Off-state leakage current	< 6 mAAC	< 6 mAAC
I <sup>2</sup> t for fusing (t=10 ms)	525 A <sup>2</sup> s [RN.F.30] 1800 A <sup>2</sup> s [RN.F.50]	525 A <sup>2</sup> s [RN.F.30..] 1800 A <sup>2</sup> s [RN.F.50..]
<b>General specifications</b>		
Operational voltage range	85-140 Arms [RN..F12..], 85-265 Arms [RN..F23..] 190-530 Arms [RN..F48..]	120-265 Arms [RN1S23..], 150-440 Arms [RN1S40..] 180-530 Arms [RN1S48..]
Blocking voltage	800 V <sub>P</sub> [RN..F12..], 800 V <sub>P</sub> [RN..F23..] 1000 V <sub>P</sub> [RN..F48..]	800 V <sub>P</sub> [RN1S23..], 1000 V <sub>P</sub> [RN1S40..] 1200 V <sub>P</sub> [RN1S48..]
Power factor	$\geq 0.9$	$\geq 0.5$
Operating temperature	-20°C to +70°C	-20°C to +70°C
Terminals	Screw captive wire clamp	Screw captive wire clamp
Approvals/Marks	CE - UR - CSA	CE - UR - CSA
<b>References</b>		
30 A	RN1F12I30 RN1F12V30 RN1F23I30 RN1F23V30 RN1F48I30 RN1F48V30	RN1S23H30NO RN1S23H30PO RN1S40H30NO RN1S40H30PO RN1S48H30NO RN1S48H30PO
50 A	RN1F12I50 RN1F12V50 RN1F23I50 RN1F23V50 RN1F48I50 RN1F48V50	RN1S23H50NO RN1S23H50PO RN1S40H50NO RN1S40H50PO RN1S48H50NO RN1S48H50PO

\* Other options available on request: Active low control input and normally closed alarm output.



# Solid state contactors, 3-phase

DIN rail mounting - AC output switching, 2 + 1 poles

Types	RGCM2A..20.. 45mm, 20 AAC	RGC2A..25.. 27 AAC	RGC2A..40.. 40 AAC	RGC2A..75.. 75 AAC
Semiconductor contactors with integrated heatsink, AC operating frequency range 45-65 Hz. Rated isolation voltage 4000 Vrms				
Dimensions HxWxD (mm)	105 x 45 x 105	110 x 54 x 103	110 x 72 x 126	141 x 72 x 141 (with fan)
Features	45 mm solid state contactor, enclosed heatsink, integrated varistors for over-voltage protection, 5 kArms SCCR, screw with clamp for power connection	54 mm solid state contactor, integrated varistors for over-voltage protection, 100 kArms SCCR, screw with clamp for power connection	72 mm solid state contactor, integrated varistors for over-voltage protection, 100 kArms SCCR, box clamp for power connection	72 mm solid state contactor, integrated overheat protection with EMR alarm output, 100 kArms SCCR, box clamp for power connection
<b>Input specifications</b>				
Control input range	5-32 VDC [RGC..D.] 20-275 VAC, 24-190 VDC [RGC..A.]	5-32 VDC [RGC..D.] 20-275 VAC, 24-190 VDC [RGC..A.]	5-32 VDC [RGC..D.] 20-275 VAC, 24-190 VDC [RGC..A.]	5-32 VDC [RG..D..DF] 5-32 VDC [RG..D..AF] 20-275 VAC [RG..A..AF]
Input current @ max. control voltage	31.5 mADC [RG..D.] 19 mAAC [RG..A.]	31.5 mADC [RG..D.] 19 mAAC [RG..A.]	31.5 mADC [RG..D.] 19 mAAC [RG..A.]	12.5 mADC [RG..D..DF] 5.5 mADC [RG..D..AF] 4.3 mAAC [RG..A..AF]
External supply voltage				24 VDC [RG..D..DF] 90-250 VAC [RG..D..AF] 90-250 VAC [RG..A..AF]
Max. supply current				150 mADC [RG..D..DF] 80 mADC [RG..D..AF] 80 mAAC [RG..A..AF]
<b>Alarm specifications</b>				
Alarm output				EMR: 2 A 230 VAC / 30 VDC
Alarm condition				Over Temperature
<b>Output specifications</b>				
Rated operational current AC-51 @ Ta = 40°C	20 AAC	27 AAC	40 AAC	75 AAC
AC-53a @ Ta = 40°C	7.6 AAC	11.5 AAC	16.5 AAC	28 AAC
Motor rating	3 kW @ 400 VAC 5 HP @ 600 VAC	5.5 kW @ 400 VAC 10 HP @ 600 VAC	7.5 kW @ 400 VAC 15 HP @ 600 VAC	11 kW @ 400 VAC 25 HP @ 600 VAC
Minimum operational current	250 mAAC	250 mAAC	400 mAAC	500 mAAC
Non. rep. surge current I <sub>tsm</sub> (t=10ms)	600 Ap	600 Ap	1150 Ap	1750 Ap
I <sup>2</sup> t for fusing (t=10ms)	1800 A <sup>2</sup> s	1800 A <sup>2</sup> s	6600 A <sup>2</sup> s	15000 A <sup>2</sup> s
<b>General specifications</b>				
Operational voltage range	42-600 VAC +10%	42-220 VAC +10% [RG..22.] 42-600 VAC +10% [RG..60.]	42-600 VAC +10%	42-600 VAC +10%
Blocking voltage	1200 Vp	800 Vp [RG..22.] 1200 Vp [RG..60.]	1200 Vp	1200 Vp
Power factor	≥ 0.5 at rated voltage	≥ 0.5 at rated voltage	≥ 0.5 at rated voltage	≥ 0.5 at rated voltage
Operating temperature	-40°C to +70°C	-40°C to +80°C	-40°C to +80°C	-40°C to +70°C [RG...DF] -40°C to +60°C [RG...AF]
Approvals / Marks	CE - cULus	CE - cULus	CE - cULus	CE - cULus
<b>References</b>				
DC control voltage 220 VAC, 800 Vp		RGC2A22D25KKE		
600 VAC, 1200 Vp	RGCM2A60D20GKE	RGC2A60D25KKE	RGC2A60D40KGE	
AC/DC control voltage 220 VAC, 800 Vp		RGC2A22A25KKE		
600 VAC, 1200 Vp	RGCM2A60A20GKE	RGC2A60A25KKE	RGC2A60A40KGE	
DC control voltage, DC external supply				RGC2A60D75GGEDF
DC control voltage, AC external supply				RGC2A60D75GGEAF
AC control voltage, AC external supply				RGC2A60A75GGEAF

# Solid state contactors, 3-phase

**DIN rail mounting - AC output switching with monitoring, 2 + 1 poles**

Types	<b>RGC2A..25..M</b> 27 AAC	<b>RGC2A..40..M</b> 40 AAC	<b>RGC2A..75..FM</b> 75 AAC
Semiconductor contactors with integrated heatsink, AC operating frequency 45-65 Hz. Rated isolation voltage output to heatsink of 4000 Vrms, 100 kArms Short Circuit Current Rating			
Dimensions HxWxD (mm)	110 x 54 x 118	110 x 72 x 141	141 x 72 x 141 (with fan)
Features	54 mm solid state contactor, EMR alarm output and electronic auxiliary output, screw with clamp for power connection	72 mm solid state contactor, EMR alarm output and electronic auxiliary output, box clamp for power connection	72 mm solid state contactor, EMR alarm output and electronic auxiliary output, box clamp for power connection

## Input specifications

Control input range	5-32 VDC [RG..D..DM] 5-32 VDC [RG..D..AM] 20-275 VAC [RG..A..AM]	5-32 VDC [RG..D..DM] 5-32 VDC [RG..D..AM] 20-275 VAC [RG..A..AM]	5-32 VDC [RG..D..DFM] 5-32 VDC [RG..D..AFM] 20-275 VAC [RG..A..AFM]
Control current @ max. control voltage	12.5 mADC [RG..D..DM] 5.5 mADC [RG..D..AM] 4.3 mAAC [RG..A..AM]	12.5 mADC [RG..D..DM] 5.5 mADC [RG..D..AM] 4.3 mAAC [RG..A..AM]	12.5 mADC [RG..D..DFM] 5.5 mADC [RG..D..AFM] 4.3 mAAC [RG..A..AFM]
External supply voltage	24 VDC [RG..D..DM] 90-250 VAC [RG..D..AM] 90-250 VAC [RG..A..AM]	24 VDC [RG..D..DM] 90-250 VAC [RG..D..AM] 90-250 VAC [RG..A..AM]	24 VDC [RG..D..DFM] 90-250 VAC [RG..D..AFM] 90-250 VAC [RG..A..AFM]
Max. supply current	60 mADC [RG..D..DM] 60 mAAC [RG..D..AM] 60 mAAC [RG..A..AM]	60 mADC [RG..D..DM] 60 mAAC [RG..D..AM] 60 mAAC [RG..A..AM]	150 mADC [RG..D..DFM] 80 mAAC [RG..D..AFM] 80 mAAC [RG..A..AFM]

## Alarm specifications

Alarm output	EMR; 2 A 250 VAC / 30 VDC	EMR; 2 A 250 VAC / 30 VDC	EMR; 2 A 250 VAC / 30 VDC
Alarm condition	Mains loss, Load loss, SSR open cct., SSR short cct., SSR over temperature	Mains loss, Load loss, SSR open cct., SSR short cct., SSR over temperature	Mains loss, Load loss, SSR open cct., SSR short cct., SSR over temperature

## Output specifications

Rated operational current AC-51 @ Ta = 40°C	27 AAC	40 AAC	75 AAC
Minimum operational current	250 mAAC	400 mAAC	500 mAAC
Non. rep. surge current I <sub>tsm</sub> (t=10ms)	600 A <sub>p</sub>	1150 A <sub>p</sub>	1750 A <sub>p</sub>
I <sup>2</sup> t for fusing (t=10ms)	1800 A <sup>2</sup> s	6600 A <sup>2</sup> s	15000 A <sup>2</sup> s
Off-state leakage current	3 mAAC	3 mAAC	3 mAAC

## General specifications





Operational voltage range	90-600 VAC +10%	90-600 VAC +10%	90-600 VAC +10%
Blocking voltage	1200 V <sub>p</sub>	1200 V <sub>p</sub>	1200 V <sub>p</sub>
Operating temperature	-40°C to +80°C [RG...DM] -40°C to +60°C [RG...AM]	-40°C to +80°C [RG...DM] -40°C to +60°C [RG...AM]	-40°C to +70°C [RG...DFM] -40°C to +60°C [RG...AFM]
Approvals / Marks	CE - cULus	CE - cULus	CE - cULus

## References

600 VAC, 1200 V <sub>p</sub>			
DC control voltage, DC external supply	<b>RGC2A60D25GKEDM</b>	<b>RGC2A60D40GGEDM</b>	<b>RGC2A60D75GGEDFM</b>
DC control voltage, AC external supply	<b>RGC2A60D25GKEAM</b>	<b>RGC2A60D40GGEAM</b>	<b>RGC2A60D75GGEAFM</b>
AC control voltage, AC external supply	<b>RGC2A60A25GKEAM</b>	<b>RGC2A60A40GGEAM</b>	<b>RGC2A60A75GGEAFM</b>



# Solid state contactors, 3-phase

DIN rail mounting - AC output switching, 3 poles

Types	<b>RGCM3A..15..</b> 45mm, 15 AAC	<b>RGC3A..10..</b> 10 AAC	<b>RGC3A..20..</b> 20 AAC	<b>RGC3A..25.. / 30..</b> 28/30 AAC
Semiconductor contactors with integrated heatsink, AC operating frequency 45-65 Hz. Rated isolation voltage output to heatsink of 4000 Vrms				
Dimensions HxWxD (mm)	105 x 45 x 105	110 x 54 x 63.5	110 x 54 x 103	110 x 72 x 126
Features	45 mm solid state contactor, enclosed heatsink, integrated varistors for over-voltage protection, 5 kArms SCCR, screw with clamp for power connection	54 mm solid state contactor, integrated varistors for over-voltage protection, 100 kArms SCCR, screw with clamp for power connection	54 mm solid state contactor, integrated varistors for over-voltage protection, 100 kArms SCCR, screw with clamp for power connection	72 mm solid state contactor, integrated varistors for over-voltage protection, 100 kArms SCCR, screw with clamp or box clamp for power connection
<b>Input specifications</b>				
Control input range	5-32 VDC [RGC..D.] 20-275 VAC, 24-190 VDC [RGC..A.]	5-32 VDC [RGC..D.] 20-275 VAC, 24-190 VDC [RGC..A.]	5-32 VDC [RGC..D.] 20-275 VAC, 24-190 VDC [RGC..A.]	5-32 VDC [RGC..D.] 20-275 VAC, 24-190 VDC [RGC..A.]
Input current @ max. control voltage	31.5 mADC [RG..D.] 19 mAAC [RG..A.]	31.5 mADC [RG..D.] 19 mAAC [RG..A.]	31.5 mADC [RG..D.] 19 mAAC [RG..A.]	31.5 mADC [RG..D.] 19 mAAC [RG..A.]
<b>Output specifications</b>				
Rated operational current AC-51 @ Ta = 40°C	15.5 AAC	10 AAC	20 AAC	28 AAC [RGC3..25] 30 AAC [RGC3..30]
AC-53a @ Ta = 40°C	5.8 AAC	5 AAC	10 AAC	11 AAC [RGC3..25] 14 AAC [RGC3..30]
Motor rating	2.2 kW @ 400 VAC 3 HP @ 600 VAC	1.5 kW @ 400 VAC 3 HP @ 600 VAC	4 kW @ 400 VAC 10 HP @ 600 VAC	4 kW @ 400 VAC [RGC3..25] 5.5 kW @ 400 VAC [RGC3..30] 10 HP @ 600 VAC [RGC3..25] 15 HP @ 600 VAC [RGC3..30]
Minimum operational current	250 mAAC	250 mAAC	250 mAAC	250 mAAC [RGC3..25] 400 mAAC [RGC3..30]
Non. rep. surge current I <sub>tsm</sub> (t=10ms)	600 A <sub>p</sub>	600 A <sub>p</sub>	600 A <sub>p</sub>	600 A <sub>p</sub> [RGC3..25] 1150 A <sub>p</sub> [RGC3..30]
I <sup>2</sup> t for fusing (t=10ms)	1800 A <sup>2</sup> s	1800 A <sup>2</sup> s	1800 A <sup>2</sup> s	1800 A <sup>2</sup> s [RGC3..25] 6600 A <sup>2</sup> s [RGC3..30]
Off-state leakage current	3 mAAC	3 mAAC	3 mAAC	3 mAAC
Critical dV/dt (@ T <sub>j</sub> init=40°C)	1000 V/us	1000 V/us	1000 V/us	1000 V/us
<b>General specifications</b>				
Operational voltage range	42-220 VAC + 10% [RG..22.] 42-600 VAC +10% [RG..60.]	42-220 VAC + 10% [RG..22.] 42-600 VAC +10% [RG..60.]	42-220 VAC + 10% [RG..22.] 42-600 VAC +10% [RG..60.]	42-600 VAC +10%
Blocking voltage	800 V <sub>p</sub> [RG..22.] 1200 V <sub>p</sub> [RG..60.]	800 V <sub>p</sub> [RG..22.] 1200 V <sub>p</sub> [RG..60.]	800 V <sub>p</sub> [RG..22.] 1200 V <sub>p</sub> [RG..60.]	1200 V <sub>p</sub>
Power factor	≥ 0.5 at rated voltage	≥ 0.5 at rated voltage	≥ 0.5 at rated voltage	≥ 0.5 at rated voltage
Operating temperature	-40°C to +70°C	-40°C to +80°C	-40°C to +80°C	-40°C to +80°C
Approvals/Marks	CE - cULus	CE - cULus - VDE	CE - cULus	CE - cULus
<b>References</b>				
DC control voltage				
220 VAC, 800 V <sub>p</sub>	<b>RGCM3A22D15GKE</b>	<b>RGC3A22D10KKE</b>	<b>RGC3A22D20KKE</b>	
600 VAC, 1200 V <sub>p</sub>	<b>RGCM3A60D15GKE</b>	<b>RGC3A60D10KKE</b>	<b>RGC3A60D20KKE</b>	28 AAC: <b>RGC3A60D25KKE</b> 30 AAC: <b>RGC3A60D30KGE</b>
AC/DC control voltage				
220 VAC, 800 V <sub>p</sub>	<b>RGCM3A22A15GKE</b>	<b>RGC3A22A10KKE</b>	<b>RGC3A22A20KKE</b>	
600 VAC, 1200 V <sub>p</sub>	<b>RGCM3A60A15GKE</b>	<b>RGC3A60A10KKE</b>	<b>RGC3A60A20KKE</b>	28 AAC: <b>RGC3A60A25KKE</b> 30 AAC: <b>RGC3A60A30KGE</b>



# Solid state contactors, 3-phase

## DIN rail mounting - AC output switching, 3 poles

Types	<b>RGC3A..40..F</b> 42 AAC	<b>RGC3A..65..F</b> 66 AAC
Semiconductor contactors with integrated heatsink, AC operating frequency 45-65 Hz. Rated isolation voltage output to heatsink of 4000 Vrms, 100 kArms Short Circuit Current Rating		
Dimensions HxWxD (mm)	135 x 54 x 118 (with fan)	141 x 72 x 141 (with fan)
Features	54 mm solid state contactor + fan, integrated overheat protection with EMR alarm output, box clamp for power connection	72 mm solid state contactor + fan, integrated overheat protection with EMR alarm output, box clamp for power connection
<b>Input specifications</b>		
Control input range	5-32 VDC [RG..D..DF] 20-275 VAC [RG..A..AF]	5-32 VDC [RG..D..DF] 5-32 VDC [RG..D..AF] 20-275 VAC [RG..A..AF]
Input current @ max. control voltage	12.5 mADC [RG..D..DF] 4.3 mAAC [RG..A..AF]	12.5 mADC [RG..D..DF] 5.5 mADC [RG..D..AF] 4.3 mAAC [RG..A..AF]
External supply voltage	24 VDC [RG..D..DF] 90-250 VAC [RG..A..AF]	24 VDC [RG..D..DF] 90-250 VAC [RG..D..AF] 90-250 VAC [RG..A..AF]
Max. supply current	150 mADC [RG..D..DF] 80 mAAC [RG..A..AF]	150 mADC [RG..D..DF] 80 mAAC [RG..D..AF] 80 mAAC [RG..A..AF]
<b>Alarm specifications</b>		
Alarm output	EMR; 2 A 250 VAC / 30 VDC	EMR; 2 A 250 VAC / 30 VDC
Alarm condition	Over Temperature	Over Temperature
<b>Output specifications</b>		
Rated operational current AC-51 @ Ta = 40°C	42 AAC	66 AAC
AC-53a @ Ta = 40°C	17 AAC	25 AAC
Motor rating	7.5 kW @ 400 VAC 15 HP @ 600 VAC	11 kW @ 400 VAC 25 HP @ 600 VAC
Minimum operational current	400 mAAC	500 mAAC
Non. rep. surge current I <sub>tsm</sub> (t=10ms)	1150 Ap	1750 Ap
I <sup>2</sup> t for fusing (t=10ms)	6600 A <sup>2</sup> s	15000 A <sup>2</sup> s
Off-state leakage current	3 mAAC	3 mAAC
Critical dV/dt (@ T <sub>j</sub> init=40°C)	1000 V/us	1000 V/us
<b>General specifications</b>		
Operational voltage range	42-600 VAC +10%	42-600 VAC +10%
Blocking voltage	1200 Vp	1200 Vp
Power factor	≥ 0.5 at rated voltage	≥ 0.5 at rated voltage
Operating temperature	-40°C to +70°C [RGC..D..DF] -40°C to +60°C [RGC..A..AF]	-40°C to +70°C [RGC..DF] -40°C to +60°C [RGC..AF]
Approvals / Marks	CE - cULus	CE - cULus
<b>References</b>		
600 VAC, 1200 Vp		
DC control voltage, DC external supply	<b>RGC3A60D40GGEDF</b>	<b>RGC3A60D65GGEDF</b>
DC control voltage, AC external supply		<b>RGC3A60D65GGEAF</b>
AC control voltage, AC external supply	<b>RGC3A60A40GGEAF</b>	<b>RGC3A60A65GGEAF</b>

# Solid state contactors, 3-phase



## DIN rail mounting - AC output switching with monitoring, 3 poles

Types	RGC3A..20..M 20 AAC	RGC3A..25/30..M 28/30 AAC	RGC3A..65..FM 66 AAC
Semiconductor contactors with integrated heatsink, AC operating frequency 45-65 Hz. Rated isolation voltage output to heatsink of 4000 Vrms, 100 kArms SCCR			
Dimensions HxWxD (mm)	110 x 54 x 118	110 x 72 x 141	141 x 72 x 141 (with fan)
Features	54 mm solid state contactor, EMR alarm output and electronic auxiliary output, screw with clamp for power connection	72 mm solid state contactor, EMR alarm output and electronic auxiliary output, screw with clamp or box clamp for power connection	72 mm solid state contactor + fan, EMR alarm output and electronic auxiliary output, box clamp for power connection
<b>Input specifications</b>			
Control input range	5-32 VDC [RG..D..DM] 5-32 VDC [RG..D..AM] 20-275 VAC [RG..A..AM]	5-32 VDC [RG..D..DM] 5-32 VDC [RG..D..AM] 20-275 VAC [RG..A..AM]	5-32 VDC [RG..D..DFM] 5-32 VDC [RG..D..AFM] 20-275 VAC [RG..A..AFM]
Control current @ max. control voltage	12.5 mADC [RG..D..DM] 5.5 mADC [RG..D..AM] 4.3 mAAC [RG..A..AM]	12.5 mADC [RG..D..DM] 5.5 mADC [RG..D..AM] 4.3 mAAC [RG..A..AM]	12.5 mADC [RG..D..DFM] 5.5 mADC [RG..D..AFM] 4.3 mAAC [RG..A..AFM]
External supply voltage	24 VDC [RG..D..DM] 90-250 VAC [RG..D..AM] 90-250 VAC [RG..A..AM]	24 VDC [RG..D..DM] 90-250 VAC [RG..D..AM] 90-250 VAC [RG..A..AM]	24 VDC [RG..D..DFM] 90-250 VAC [RG..D..AFM] 90-250 VAC [RG..A..AFM]
Max. supply current	60 mADC [RG..D..DM] 60 mAAC [RG..D..AM] 60 mAAC [RG..A..AM]	60 mADC [RG..D..DM] 60 mAAC [RG..D..AM] 60 mAAC [RG..A..AM]	150 mADC [RG..D..DFM] 80 mAAC [RG..D..AFM] 80 mAAC [RG..A..AFM]
<b>Alarm specifications</b>			
Alarm output	EMR; 2 A 250 VAC / 30 VDC	EMR; 2 A 250 VAC / 30 VDC	EMR; 2 A 250 VAC / 30 VDC
Alarm condition	Mains loss, Load loss, SSR open cct., SSR short cct., SSR over temperature	Mains loss, Load loss, SSR open cct., SSR short cct., SSR over temperature	Mains loss, Load loss, SSR open cct., SSR short cct., SSR over temperature
<b>Output specifications</b>			
Rated operational current AC-51 @ Ta = 40°C	20 AAC	28 AAC [RGC3..25] 30 AAC [RGC3..30]	66 AAC
Minimum operational current	250 mAAC	250 mAAC [RGC3..25] 400 mAAC [RGC3..30]	500 mAAC
Non. rep. surge current I <sub>ism</sub> (t=10ms)	600 A <sub>p</sub>	600 A <sub>p</sub> [RGC3..25] 1150 A <sub>p</sub> [RGC3..30]	1750 A <sub>p</sub>
Off-state leakage current	3 mAAC	3 mAAC	3 mAAC
I <sup>2</sup> t for fusing (t=10ms)	1800 A <sup>2</sup> s	1800 A <sup>2</sup> s [RGC3..25] 6600A <sup>2</sup> s [RGC3..30]	15000 A <sup>2</sup> s
Critical dV/dt (@ T <sub>j</sub> init=40°C)	1000 V/us	1000 V/us	1000 V/us
<b>General specifications</b>			
Operational voltage range	90-600 VAC +10%	90-600 VAC +10%	90-600 VAC +10%
Blocking voltage	1200 V <sub>p</sub>	1200 V <sub>p</sub>	1200 V <sub>p</sub>
Operating temperature	-40°C to +80°C [RG...DM] -40°C to +60°C [RG...AM]	-40°C to +80°C [RG...DM] -40°C to +60°C [RG...AM]	-40°C to +70°C [RG...DFM] -40°C to +60°C [RG...AFM]
Approvals / Marks	CE - cULus	CE - cULus	CE - cULus
<b>References</b>			
DC control voltage, DC external supply	RGC3A60D20GKEDM	28AAC: RGC3A60D25GKEDM 30AAC: RGC3A60D30GGEDM	RGC3A60D65GGEDFM
DC control voltage, AC external supply	RGC3A60D20GKEAM	28AAC: RGC3A60D25GKEAM 30AAC: RGC3A60D30GGEAM	RGC3A60D65GGEAFM
AC control voltage, AC external supply	RGC3A60A20GKEAM	28AAC: RGC3A60A25GKEAM 30AAC: RGC3A60A30GGEAM	RGC3A60A65GGEAFM





# Solid state contactors, 3-phase

## 4-20 mA Proportional controllers, 2 + 1 poles

Types	<b>RGC2P60AA15C1</b> 15 AAC	<b>RGC2P60AA25C1</b> 27 AAC	<b>RGC2P60AA40C1</b> 40 AAC
3-phase semiconductor proportional controllers with integrated heatsink, AC operating frequency range 45-65 Hz. Rated isolation voltage 4000 Vrms, 100 kArms short circuit current rating			
Dimensions HxWxD (mm)	110 x 54 x 103	110 x 54 x 103	110 x 72 x 126
Features	54 mm solid state contactor with integrated varistors for over-voltage protection, screw with clamp for power connection	54 mm solid state contactor with integrated varistors for over-voltage protection, screw with clamp for power connection	72 mm solid state contactor, integrated varistors for over-voltage protection, box clamp for power connection
<b>Input specifications</b>			
Control input	4-20 mADC	4-20 mADC	4-20 mADC
Voltage drop	<10 VDC @ 20 mADC	<10 VDC @ 20 mADC	<10 VDC @ 20 mADC
<b>Types</b>			
Switching mode	1 Full Cycle [RGC..C1..]	1 Full Cycle [RGC..C1..]	1 Full Cycle [RGC..C1..]
<b>Output specifications</b>			
Rated operational current AC-51 @ Ta = 40°C	15 AAC	27 AAC	40 AAC
Minimum operational current	500 mAAC	500 mAAC	500 mAAC
Non. rep. surge current I <sub>tsm</sub> (t=10ms)	600 Ap	600 Ap	1150 Ap
I <sup>2</sup> t for fusing (t=10ms)	1800 A <sup>2</sup> s	1800 A <sup>2</sup> s	6600 A <sup>2</sup> s
Off-state leakage current	5 mAAC	5 mAAC	5 mAAC
Critical dV/dt (@ T <sub>j</sub> init=40°C)	1000 V/us	1000 V/us	1000 V/us
<b>General specifications</b>			
Operational voltage range	180-600 VAC +10%	180-600 VAC +10%	180-600 VAC +10%
Blocking voltage	1200 V <sub>P</sub>	1200 V <sub>P</sub>	1200 V <sub>P</sub>
Power factor	≥ 0.7 at rated voltage	≥ 0.7 at rated voltage	≥ 0.7 at rated voltage
Operating temperature	-40°C to +70°C	-40°C to +70°C	-40°C to +70°C
Approvals / Marks	CE - cULus	CE - cULus	CE - cULus
<b>References</b>			
Control Input:	<b>4-20 mADC</b>	<b>4-20 mADC</b>	<b>4-20 mADC</b>
1 Full Cycle	<b>RGC2P60AA15C1</b>	<b>RGC2P60AA25C1</b>	<b>RGC2P60AA40C1</b>



# Solid state contactors, 3-phase

## Proportional controllers with monitoring, 2 + 1 poles

Types	<b>RGC2P..25..M</b> 27 AAC	<b>RGC2P..40..M</b> 40 AAC	<b>RGC2P..75..FM</b> 75 AAC
Semiconductor contactors with integrated heatsink, AC operating frequency 45-65 Hz. Rated isolation voltage output to heatsink of 4000 Vrms, 100 kArms short circuit current rating			
Dimensions HxWxD (mm)	110 x 54 x 118	110 x 72 x 141	141 x 72 x 141 (with fan)
Features	54 mm solid state contactor with integrated varistors for over-voltage protection, system monitoring, screw with clamp for power connection	72 mm solid state contactor with integrated varistors for over-voltage protection, system monitoring, box clamp for power connection	72 mm solid state contactor with fan and system monitoring, integrated varistors for over-voltage protection, box clamp for power connection
<b>Input specifications</b>			
Control input	0-20, 4-20, 12-20 mADC [RGC..I..] 0-10, 0-5, 1-5 VDC [RGC..V..] External potentiometer [RGC..V..]	0-20, 4-20, 12-20 mADC [RGC..I..] 0-10, 0-5, 1-5 VDC [RGC..V..] External potentiometer [RGC..V..]	0-20, 4-20, 12-20 mADC [RGC..I..] 0-10, 0-5, 1-5 VDC [RGC..V..] External potentiometer [RGC..V..]
Input impedance	<250 ohms [RGC..I..] 100k ohms [RGC..V..]	<250 ohms [RGC..I..] 100k ohms [RGC..V..]	<250 ohms [RGC..I..] 100k ohms [RGC..V..]
External supply voltage	24 VDC/AC	24 VDC/AC	24 VDC/AC [RGC..DFM] 90-250 VAC [RGC..AFM]
Max. supply current	90 mADC/AC	90 mADC/AC	175 mADC/AC [RGC..DFM] 60 mAAC [RGC..AFM]
<b>Alarm specifications</b>			
Alarm output	EMR; 2 A 250 VAC / 30 VDC	EMR; 2 A 250 VAC / 30 VDC	EMR; 2 A 250 VAC / 30 VDC
Alarm condition	Mains loss, Load loss, SSR open cct., SSR short cct., SSR over temperature	Mains loss, Load loss, SSR open cct., SSR short cct., SSR over temperature	Mains loss, Load loss, SSR open cct., SSR short cct., SSR over temperature
<b>Types</b>			
Switching mode	1 Full Cycle [RGC..C1..] 4 Full Cycles [RGC..C4..]	1 Full Cycle [RGC..C1..] 4 Full Cycles [RGC..C4..]	1 Full Cycle [RGC..C1..] 4 Full Cycles [RGC..C4..]
<b>Output specifications</b>			
Rated operational current AC-51 @ Ta = 40°C	27 AAC	40 AAC	75 AAC
Minimum operational current	500 mAAC	500 mAAC	500 mAAC
Non. rep. surge current I <sub>tsm</sub> (t=10ms)	600 A <sub>p</sub>	1150 A <sub>p</sub>	1750 A <sub>p</sub>
I <sup>2</sup> t for fusing (t=10ms)	1800 A <sup>2</sup> s	6600 A <sup>2</sup> s	15000 A <sup>2</sup> s
Off-state leakage current	5 mAAC	5 mAAC	5 mAAC
Critical dV/dt (@ T <sub>j</sub> init=40°C)	1000 V/us	1000 V/us	1000 V/us
<b>General specifications</b>			
Operational voltage range	180-600 VAC +10%	180-600 VAC +10%	180-600 VAC +10%
Blocking voltage	1200 V <sub>r</sub>	1200 V <sub>r</sub>	1200 V <sub>r</sub>
Power factor	≥ 0.7 at rated voltage	≥ 0.7 at rated voltage	≥ 0.7 at rated voltage
Operating temperature	-40°C to +70°C max. +60°C for 24 VAC supply	-40°C to +70°C max. +60°C for 24 VAC supply	-40°C to +70°C max. +60°C for 24 VAC supply
Approvals / Marks	CE - cULus	CE - cULus	CE - cULus
<b>References</b>			
Control Input:	<b>0-20, 4-20, 12-20 mADC</b>	<b>0-20, 4-20, 12-20 mADC</b>	<b>0-20, 4-20, 12-20 mADC</b>
1 Full Cycle, DC external supply	<b>RGC2P60I25C1DM</b>	<b>RGC2P60I40C1DM</b>	<b>RGC2P60I75C1DFM</b>
1 Full Cycle, AC external supply			<b>RGC2P60I75C1AFM</b>
4 Full Cycles, DC external supply	<b>RGC2P60I25C4DM</b>	<b>RGC2P60I40C4DM</b>	<b>RGC2P60I75C4DFM</b>
4 Full Cycles, AC external supply			<b>RGC2P60I75C4AFM</b>
Control Input:	<b>0-10, 0-5, 1-5 VDC, Pot</b>	<b>0-10, 0-5, 1-5 VDC, Pot</b>	<b>0-10, 0-5, 1-5 VDC, Pot</b>
1 Full Cycle, DC external supply	<b>RGC2P60V25C1DM</b>	<b>RGC2P60V40C1DM</b>	<b>RGC2P60V75C1DFM</b>
1 Full Cycle, AC external supply			<b>RGC2P60V75C1AFM</b>



## Solid state contactors, 3-phase

### 4-20 mA Proportional controllers, 3 poles

Types	<b>RGC3P60AA20..</b> 20 AAC	<b>RGC3P60AA30..</b> 30 AAC
3-phase semiconductor proportional controllers with integrated heatsink, AC operating frequency range 45-65 Hz. Rated isolation voltage 4000 Vrms, 100 kArms short circuit current rating		
Dimensions HxWxD (mm)	110 x 54 x 103	110 x 72 x 126
Features	54 mm solid state contactor with integrated varistors for over-voltage protection, screw with clamp for power connection	72 mm solid state contactor, integrated varistors for over-voltage protection, box clamp for power connection
<b>Input specifications</b>		
Control input	4-20 mADC	4-20 mADC
Voltage drop	<10 VDC @ 20 mADC	<10 VDC @ 20 mADC
<b>Types</b>		
Switching mode	Phase Angle [RGC..E] 1 Full Cycle [RGC..C1]	Phase Angle [RGC..E] 1 Full Cycle [RGC..C1]
<b>Output specifications</b>		
Rated operational current AC-51 @ Ta = 40°C	20 AAC	30 AAC
Minimum operational current	500 mAAC	500 mAAC
Non. rep. surge current I <sub>tsm</sub> (t=10ms)	600 A <sub>p</sub>	1150 A <sub>p</sub>
I <sup>2</sup> t for fusing (t=10ms)	1800 A <sup>2</sup> s	6600 A <sup>2</sup> s
Off-state leakage current	5 mAAC	5 mAAC
Critical dV/dt (@ T <sub>j</sub> init=40°C)	1000 V/us	1000 V/us
<b>General specifications</b>		
Operational voltage range	180-600 VAC +10%	180-600 VAC +10%
Blocking voltage	1200 V <sub>p</sub>	1200 V <sub>p</sub>
Power factor	≥ 0.7 at rated voltage	≥ 0.7 at rated voltage
Operating temperature	-40°C to +70°C	-40°C to +70°C
Approvals / Marks	CE - cULus	CE - cULus
<b>References</b>		
Control Input:	<b>4-20 mADC</b>	<b>4-20 mADC</b>
Phase Angle	<b>RGC3P60AA20E</b>	<b>RGC3P60AA30E</b>
1 Full Cycle	<b>RGC3P60AA20C1</b>	<b>RGC3P60AA30C1</b>

# Solid state contactors, 3-phase

## Proportional controllers with monitoring, 3 poles

Types	RGC3P..20..EP RGC3P..20..M 20 AAC	RGC3P..30..EP RGC3P..30..M 30 AAC	RGC3P..65..EFP RGC3P..65..FM 66 AAC
Semiconductor contactors with integrated heatsink, AC operating frequency 45-65 Hz. Rated isolation voltage output to heatsink of 4000 Vrms, 100 kArms short circuit current rating			
Dimensions HxWxD (mm)	110 x 54 x 118	110 x 72 x 141	141 x 72 x 141 (with fan)
Features	54 mm solid state contactor with integrated varistors for over-voltage protection, system monitoring, screw with clamp for power connection	72 mm solid state contactor with integrated varistors for over-voltage protection, system monitoring, box clamp for power connection	72 mm solid state contactor with fan and system monitoring, integrated varistors for over-voltage protection, box clamp for power connection

### Input specifications

Control input	0-20, 4-20, 12-20 mADC [RGC..I..] 0-10, 0-5, 1-5 VDC [RGC..V..] External potentiometer [RGC..V..]	0-20, 4-20, 12-20 mADC [RGC..I..] 0-10, 0-5, 1-5 VDC [RGC..V..] External potentiometer [RGC..V..]	0-20, 4-20, 12-20 mADC [RGC..I..] 0-10, 0-5, 1-5 VDC [RGC..V..] External potentiometer [RGC..V..]
Input impedance	<250 ohms [RGC..I..] 100k ohms [RGC..V..]	<250 ohms [RGC..I..] 100k ohms [RGC..V..]	<250 ohms [RGC..I..] 100k ohms [RGC..V..]
External supply voltage	24 VDC/AC [RGC..DM] 90-250 VAC [RGC..AM]	24 VDC/AC [RGC..DM] 90-250 VAC [RGC..AM]	24 VDC/AC [RGC..DFM] 90-250 VAC [RGC..AFM]
Max. supply current	90 mADC/AC [RGC..DM] 30 mAAC [RGC..AM]	90 mADC/AC [RGC..DM] 30 mAAC [RGC..AM]	175 mADC/AC [RGC..DFM] 60 mAAC [RGC..AFM]

### Alarm specifications

Alarm output	EMR; 2A 250 VAC / 30 VDC	EMR; 2A 250 VAC / 30 VDC	EMR; 2A 250 VAC / 30 VDC
Alarm condition	Mains loss, Load loss, SSR open cct., SSR short cct., SSR over temperature	Mains loss, Load loss, SSR open cct., SSR short cct., SSR over temperature	Mains loss, Load loss, SSR open cct., SSR short cct., SSR over temperature

### Types

Switching mode	Phase Angle [RGC..E..] 1 Full Cycle [RGC..C1..] 4 Full Cycles [RGC..C4..] 16 Full Cycles [RGC..C16..] Softstart [RGC..S..]	Phase Angle [RGC..E..] 1 Full Cycle [RGC..C1..] 4 Full Cycles [RGC..C4..] 16 Full Cycles [RGC..C16..] Softstart [RGC..S..]	Phase Angle [RGC..E..] 1 Full Cycle [RGC..C1..] 4 Full Cycles [RGC..C4..] 16 Full Cycles [RGC..C16..] Softstart [RGC..S..]
----------------	--	--	--

### Output specifications

Rated operational current AC-51 @ Ta = 40°C	20 AAC	30 AAC	66 AAC
Minimum operational current	500 mAAC	500 mAAC	500 mAAC
Non. rep. surge current I <sub>ism</sub> (t=10ms)	600 Ap	1150 Ap	1750 Ap
I <sup>2</sup> t for fusing (t=10ms)	1800 A <sup>2</sup> s	6600 A <sup>2</sup> s	15000 A <sup>2</sup> s
Off-state leakage current	5 mAAC	5 mAAC	5 mAAC
Critical dV/dt (@ Tj init = 40°C)	1000 V/us	1000 V/us	1000 V/us

### General specifications

Operational voltage range	180-600 VAC +10%	180-600 VAC +10%	180-600 VAC +10%
Blocking voltage	1200 Vp	1200 Vp	1200 Vp
Power factor	≥ 0.7 at rated voltage	≥ 0.7 at rated voltage	≥ 0.7 at rated voltage
Operating temperature	-40°C to +70°C max. +60°C for 24 VAC supply	-40°C to +70°C max. +60°C for 24 VAC supply	-40°C to +70°C max. +60°C for 24 VAC supply
Approvals / Marks	CE - cULus	CE - cULus	CE - cULus



### References

Phase Angle, DC external supply	RGC3P60Y20EDP	RGC3P60Y30EDP	RGC3P60Y65EDFP
Phase Angle, AC external supply	RGC3P60Y20EAP	RGC3P60Y30EAP	RGC3P60Y65EAFP
X Full Cycle, DC external supply	RGC3P60Y20CXDM (X = 1/4/16)	RGC3P60Y30CXDM (X = 1/4/16)	RGC3P60Y65CXDFM (X = 1/4/16)
X Full Cycle, AC external supply	RGC3P60Y20CXAM (X = 1/4/16)	RGC3P60Y30CXAM (X = 1/4/16)	RGC3P60Y65CXAFM (X = 1/4/16)
Softstart + 16 Full Cycles, DC external supply	RGC3P60V20S16DM	RGC3P60V30S16DM	RGC3P60V65S16DFM
Digital Control Input (5-10VDC):	5-10VDC	5-10VDC	5-10VDC
Softstart + ON/OFF, DC external supply	RGC3P60V20SDM	RGC3P60V30SDM	RGC3P60V65SDFM

Y = '1' for 0-20 mA, 4-20 mA or 12-20 mA or 'V' for 0-10 V, 0-5 V, 1-5 V or pot





# 45 mm Solid state contactors for motor switching, 3-phase

Ready for use design - DIN rail mounting

Types	<b>REC2B</b> 4 kW	<b>REC3B</b> 3 kW	<b>REC2R</b> 3 kW
Semiconductor contactors with integrated heatsink. AC operating frequency range 45-65 Hz. Rated isolation voltage $\geq 4000$ Vrms			
Dimensions HxWxD (mm)	105 x 45 x 99.4	105 x 45 x 99.4	105 x 45 x 99.4
Features	2ph switching Electronic motor contactor	3ph switching Electronic motor contactor	2ph switching Electronic motor contactor for reversing
<b>Control specifications</b>			
Control input range	15-32 VDC [REC..D] 90-253 VAC [REC..A]	15-32 VDC [REC..D] 90-253 VAC [REC..A]	15-32 VDC [REC..D] 90-253 VAC [REC..A]
Max. input current	10 mADC [REC..D] 15 mAAC [REC..A]	10 mADC [REC..D] 15 mAAC [REC..A]	10 mADC [REC..D] 15 mAAC [REC..A]
<b>Output specifications</b>			
Rated operational current AC53a @ Ta= 40°C, 400 VAC	6.2 AAC [REC2B..20] 7.6 AAC [REC2B..30] 9.2 AAC [REC2B..40]	5.8 AAC [REC3B..20] 5.8 AAC [REC3B..21] 7.6 AAC [REC3B..30]	6.2 AAC [REC2R..20] 7.6 AAC [REC2R..30]
Motor Rating @ 400 VAC UL508/IEC60947-4-2 @40°C	3HP / 2.2 kW [REC2B..20] 3HP / 3.0 kW [REC2B..30] 3HP / 4.0 kW [REC2B..40]	2HP / 2.2 kW [REC3B..20] 2HP / 2.2 kW [REC3B..21] 3HP / 3.0 kW [REC3B..30]	3HP / 2.2 kW [REC2R..20] 3HP / 3.0 kW [REC2R..30]
Min. operational current	150 mA [RECB..20]	150 mA [REC3B..20]	150 mA [REC2R..20]
Non repet. surge current (I <sub>tsm</sub> ) (t=10 ms)	325 Ap [REC2B..20] 600 Ap [REC2B..30] 800 Ap [REC2B..40]	325 Ap [REC3B48..20] 600 Ap [REC3B60..20] 600 Ap [REC3..21] 800 Ap [REC3..30]	600 Ap
Max. Off-state leak current	< 3 mAAC	< 3 mAAC	< 3 mAAC
I <sup>2</sup> t for fusing (t=10 ms)	525 A <sup>2</sup> s [REC2..20] 525 A <sup>2</sup> s [REC2.48..30] 1800 A <sup>2</sup> s [REC2.60..30] 3200 A <sup>2</sup> s [REC2.40]	525A <sup>2</sup> s [REC3B48..20] 1800 A <sup>2</sup> s [REC3B60..20] 1800 A <sup>2</sup> s [REC3..21] 3200 A <sup>2</sup> s [REC3.40]	1800 A <sup>2</sup> s
Critical dV/dt (@ T <sub>j</sub> init=40°C)	1000 V/μs	1000 V/μs	1000 V/μs
<b>General specifications</b>			
Operational voltage range	48 - 530 VAC [REC..48..] 48 - 600 VAC [REC..60..]	48 - 530 VAC [REC..48..] 48 - 600 VAC [REC..60..]	48 - 530 VAC [REC..48..] 48 - 600 VAC [REC..60..]
Blocking voltage	1200 V <sub>P</sub> [REC..48..] 1600 V <sub>P</sub> [REC..60..]	1200 V <sub>P</sub> [REC..48..] 1600 V <sub>P</sub> [REC..60..]	1200 V <sub>P</sub> [REC..48..] 1600 V <sub>P</sub> [REC..60..]
Power factor	$\geq 0.5$ at rated voltage	$\geq 0.5$ at rated voltage	$\geq 0.5$ at rated voltage
Operating temperature	-25°C to +60°C	-25°C to +60°C	-25°C to +60°C
Terminals	input screw/spring, output screw	input screw/spring, output screw	input screw/spring, output screw
Approvals/Marks	CE - cULus	CE - cULus	CE - cULus
<b>References</b>			
	2.2 kW	2.2 kW	2.2 kW
	<b>REC2B48D20GKE</b>	<b>REC3B48D20GKE</b>	<b>REC2R48D20GKE</b>
	<b>REC2B48A20GKE</b>	<b>REC3B48A20GKE</b>	<b>REC2R48A20GKE</b>
	3.0 kW	<b>REC3B60D20GKE</b>	3.0 kW
	<b>REC2B48D30GKE</b>	<b>REC3B60A20GKE</b>	<b>REC2R48D30GKE</b>
	<b>REC2B48A30GKE</b>	2.2 kW (high I <sub>tsm</sub> )	<b>REC2R48A30GKE</b>
	<b>REC2B60D30GKE</b>	<b>REC3B48D21GKE</b>	<b>REC2R60D30GKE</b>
	<b>REC2B60A30GKE</b>	3.0 kW	<b>REC2R60A30GKE</b>
	4.0 kW	<b>REC3B48D30GKE</b>	
	<b>REC2B48D40GKE</b>	<b>REC3B48A30GKE</b>	
	<b>REC2B48A40GKE</b>		





## Solid state relays accessories

### General accessories

Types	RPM1	RPM1P	RPM1V	RPM2
				
Dimensions HxWxD (mm)	84 x 12.5 x 42	84 x 12.5 x 42	84 x 12.5 x 42	82 x 25 x 39
Description	Din-rail adaptor for PCB relays. (Relay excluded)	Din-rail adaptor with sockets for plug-in PCB relays. (Relay excluded)	DIN-rail adaptor for PCB relays with LED and varistor across output terminals. (Relay excluded)	Din-rail adaptor for PCB relays with an operational voltage ≥ 230 V. (Relay excluded)
Pack Quantity	1	1	1	2
<b>References</b>	<b>RPM1</b>	<b>RPM1P (no LED) RPM1PD (with LED)</b>	<b>RPM1V</b>	<b>RPM2</b>



### Selection guide for SSR assemblies\*

<b>RP...M1</b>	<b>RP...M1P (no LED) RP...M1PD (with LED)</b>	<b>RP...M1V</b>	<b>RP...M2</b>
----------------	---	-----------------	----------------

Types	DIN Adaptor	DIN Adaptor RG	Protection cover RM	Protection cover RA
				
Dimensions HxWxD (mm)	81 x 44 x 13.5	106 x 17.8 x 14	58 x 45 x 9	59 x 45 x 25.5
Description	DIN-rail adaptor for 1-phase SSR & heatsink assemblies. Integrated in heatsink kits.	DIN-rail adaptor for RGS relays.	Clip-on IP20 protection Cover for RAM, RM, RS	Protection cover for RA and RD series
Pack Quantity	1	1	20	25
<b>References</b>	<b>RHS00</b>	<b>RGS1DIN</b>	<b>RMIP20</b>	<b>BBR BBR-S (for RA..S series)</b>

### Selection guide for SSR assemblies\*

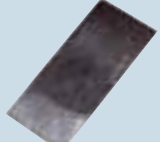

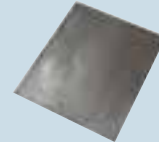

<b>R...H8</b>	<b>RGS...DIN</b>
---------------	------------------





Types	Thermal paste	Thermal pad Slim SSRs	Thermal Pad RM, RA	Thermal pad RZ3
				
Dimensions HxWxD (mm)		34.6 x 14 x 0.13 (RG) 21 x 19 x 0.13 (RF)	42 x 35 x 0.25	70 x 77 x 0.25
Description	2 ml syringe silicon based thermal compound	Thermal pad for RG and RF series	Graphite thermal pad for RA, RD, RM, RAM, RS series	Graphite thermal pad for RZ3 series
Pack Quantity	1	10	50	10
<b>References</b>	<b>HTS02S</b>	<b>RGHT (for RG series) RFHT (for RF series)</b>	<b>KK071CUT</b>	<b>RZHT</b>



\* Conditions may apply. Please ask your Sales representative for further details.

# Solid state relays accessories

## Terminal Adaptors

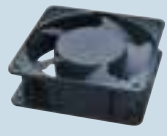

Types	RM fork terminal	RM fork terminal IP20	RM FASTON terminals	RM spacers
				
Dimensions HxWxD (mm)	35 x 16.5 x 25	35 x 16.5 x 29	4.8 / 6.3	M3 x 12
Description	RM, RS, RAM terminal adaptor for 16 mm <sup>2</sup> and 35 mm <sup>2</sup> cable	RM, RS, RAM terminal adaptor for 35 mm <sup>2</sup> cable, IP20	Screw FASTON terminals, flat or 45° angled for output (6.3 mm) and input (4.8 mm) RM, RS, RAM terminals	Standoff spacer for RM, RS, RAM series M3 control terminals
Pack Quantity	10	10	20	20
<b>References</b>	<b>RM625FK</b> (16 mm <sup>2</sup> ) <b>RM635FK</b> (35 mm <sup>2</sup> )	<b>RM635FKP</b>	<b>RM48FO</b> (4.8 mm, flat) <b>RM48F4</b> (4.8 mm, 45°) <b>RM63FO</b> (6.3 mm, flat) <b>RM63F4</b> (6.3 mm, 45°)	<b>RMSP03</b>



Types	RG plug terminals	RG plug terminals	Overload Relay Adaptor	Varistors
				
Description	2 pole spring loaded plug terminal, 2.5 mm <sup>2</sup> for RG series	3 way, 2 pole box clamp plug terminal, 2.5 mm <sup>2</sup> for RGCM3 series	Overload Relay Adaptor for REC and RGCM3 series	Surge / transient voltage protection for SSRs
Pack Quantity	10	10	5	10
<b>References</b>	<b>RGM25</b>	<b>RG3G25</b>	<b>REC3ADAPTOR</b>	275 V: <b>RV02</b> 420 V: <b>RV04</b> 510 V: <b>RV05</b> 625 V: <b>RV06</b> 680 V: <b>RV07</b>

Types	Cables	Fans	Screw Kits	Temperature limit switches
				
Dimensions HxWxD (mm)		40 x 40 x 20 (RHSF40) 60 x 60 x 20 (RHSF60) 120 x 120 x 38 (RHS301F)		6.5 x 5.5 x 3
Description	Cable for RM1E...V, RA2A...C and RA...S models with one-end terminated with a female plug for mounting on the SSR	RHSF40-24 to be mounted with RHS45C, RHS45B, RHS540, RHS542 RHSF60-24/240 to be mounted with RHS90A, RHS112A, RHS703 RHS301F115/230 to be mounted with RHS301 incl. bracket	Screw kits for assembling SSRs to heatsinks. M5 x 10 mm to be used with RA, RD, RM, RAM, RS and RZ3 series. M4 x 15 mm used for RHS38AD heatsink. M5 x 23 / 30 mm to be used with RG series.	Temperature limit switches that may be fitted in the RZ3 housing between SSR and heatsink
	1	1	20	1
<b>References</b>	<b>RCS3-100-1 [RM1E..V]</b> <b>RCS4-100-1 [RA2A..C]</b> <b>RCS4-400-1 [RA2A..C]</b> <b>RCS5-200-1 [RA..S]</b>	<b>RHSF40-24</b> (24 VDC) <b>RHSF60-24</b> (24 VDC) <b>RHSF60-230</b> (240 VAC) <b>RHS301F115</b> (115 VAC) <b>RHS301F230</b> (230 VAC)	<b>SRWKITM5X10MM</b> <b>SRWKITM4X15MM</b> <b>SRWKITM5X23MM</b> <b>SRWKITM5X30MM</b>	<b>UP62-70</b> <b>UP62-80</b> <b>UP62-90</b>

# Solid state relays accessories

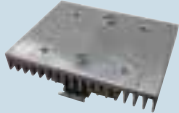
## DIN mount heatsinks for solid state relays

Types	RHS300	RHS37A	RHS10015
			
Dimensions HxWxD (mm) (SSR not included)	105 x 82 x 20	18 x 110 x 52	100 x 82 x 29
Description	Heatsink for 1x 3-phase RZ3 series	Heatsink for 1x 1-phase RG series	Heatsink for max. 2x 1-phase RA, RD, RM, RAM, RS series
<b>Thermal resistance**</b>			
Without fan	5.40°C/W (>30 W)	4.00°C/W (>20 W)	4.00°C/W (>30 W)
With fan	Not available	Not available	Not available
<b>Selection guide for heatsink assemblies*</b>			
Without fan	R...H1	R...H51	R...H47
With fan	Not available	Not available	Not available

Types	RHS100	RHS45C	RHS52A
			
Dimensions HxWxD (mm) (SSR not included)	44 x 82 x 48	45 x 103 x 55	22.5 x 110 x 90
Description	Heatsink for 1x 1-phase RA, RD, RM, RAM, RS series	Heatsink for 1x 1-phase RA, RD, RM, RAM, RS series	Heatsink for 1x 1-phase RG series
<b>Thermal resistance**</b>			
Without fan	3.10°C/W (>25 W)	2.20°C/W (>45 W)	2.00°C/W (>45 W)
With fan	Not available	Not Available	Not Available
<b>Selection guide for heatsink assemblies*</b>			
Without fan	R...H0	R...H15	R...H61
With fan	Not available	Not available	Not available

Types	RHS45B	RHS54..	RHS703..
			
Dimensions HxWxD (mm) (SSR not included)	45 x 103 x 80	54 x 110 x 51 54 x 135 x 51 (with fan)	72 x 110 x 75 72 x 141 x 75 (with fan)
Description	Heatsink for 1x 1-phase RA, RD, RM, RAM, RS series	Heatsink for max. 3x 1-phase RG series, 1x 1-phase RA, RD, RM, RAM, RS series: RHS540 (no fan) RHS540F40-24 (24 VDC fan) Heatsink for max. 2x 1-phase RG series: RHS542 (no fan) RHS542F40-24 (24 VDC fan)	Heatsink for max. 3x 1-phase RG series, 1x 1-phase RA, RD, RM, RAM, RS series: RHS703 (no fan) RHS703F60-24 (24 VDC fan) RHS703F60-230 (240 VAC fan)
<b>Thermal resistance**</b>			
Without fan	1.85°C/W (>50 W)	1.85°C/W (>60 W)	1.10°C/W (>60 W)
With fan	Not Available	0.65°C/W	0.37°C/W
<b>Selection guide for heatsink assemblies*</b>			
Without fan	R...H5	R...H65 [RHS540] R...H66 [RHS542]	R...H75 [RHS703]
With fan	Not available	R...H67 [RHS540F40-24] R...H68 [RHS542F40-24]	R...H76 [RHS703F60-24] R...H77 [RHS703F60-230]



\* Conditions may apply. Please ask your Sales representative for further details.

\*\* Refer to specific heatsink datasheet for further details on heatsink characteristics and assemblies.

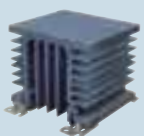

# Solid state relays accessories

## DIN mount heatsinks for solid state relays

Types	RHS90A	RHS301..	RHS112A..
			
Dimensions HxWxD (mm) (SSR not included)	90 x 103 x 80	119 x 82 x 94 124 x 146 x 122 (with fan)	112 x 103 x 80 112 x 120 x 80 (with fan)
Description	Heatsink for 1x 1-phase RA, RD, RM, RAM, RS series	Heatsink for 1x 3-phase RZ3, 2x 1-phase RA, RD, RM, RAM, RS series: RHS301 [no fan] RHS301F115C [115 VAC fan] RHS301F230C [230 VAC fan]	Heatsink for 1x 3-phase RZ3, 2x 1-phase RA, RD, RM, RAM, RS series: RHS112A [no fan] RHS112AF60-24 [24 VDC fan] RHS112AF60-230 [230 VAC fan]
<b>Thermal resistance**</b>			
Without fan	0.97°C/W (>60 W)	0.82°C/W (>80W)	0.76°C/W (>100 W)
With fan	Not Available	0.28°C/W	0.35°C/W
<b>Selection guide for heatsink assemblies*</b>			
Without fan	R...H16	R...H2 [RHS301]	R...H17
With fan	Not available	R...H10 [RHS301F115C] R...H12 [RHS301F230C]	R...H18 [RHS112AF60-24] R...H52 [RHS112AF60-230]

Types	RHS11267DIND	RHS28009F80-24P	RHS28011F80-24P
			
Dimensions HxWxD (mm) (SSR not included)	119 x 125 x 94	280 x 87 x 122	280 x 87 x 122
Description	Heatsink for 1x 3-phase RZ3 series, max 3x 1-phase RG series, 2x 1-phase RA, RD, RM, RAM, RS series	Heatsink for max. 9x 1-phase RG series or 4x 1-phase RA, RD, RM, RAM, RS series with integrated fan and overtemperature protection	Heatsink for max. 11x 1-phase RG series or 3x 1-phase RA, RD, RM, RAM, RS series with integrated fan and overtemperature protection
<b>Thermal resistance**</b>			
Without fan	0.54°C/W (>150 W)	Not available	Not available
With fan	Not available	0.12°C/W (24 VDC)	0.12°C/W (24 VDC)
<b>Selection guide for heatsink assemblies*</b>			
Without fan	R...H78D	Not available	Not available
With fan	Not available	R...H41	R...H44

## Thru wall mount heatsinks for solid state relays

Types	RHS10025D	RHS16225D	RHS16225LD
			
Dimensions HxWxD (mm) (SSR not included)	100 x 100 x 25	162 x 100 x 25	162 x 250 x 25
Description	Heatsink for max. 3x 1-phase RG series, 1x 1-phase RA, RD, RM, RAM, RS series	Heatsink for 1x 3-phase RZ3 series, max. 3x 1-phase RA, RD, RM, RAM, RS and RG series	Heatsink for 1x 3-phase RZ3 series, max. 3x 1-phase RA, RD, RM, RAM, RS and RG series
<b>Thermal resistance**</b>			
Without fan	1.85°C/W (>60 W)	1.30°C/W (>90 W)	0.84°C/W (>120 W)
With fan	Not Available	Not Available	Not Available
<b>Selection guide for heatsink assemblies*</b>			
Without fan	R...H49	R...H55	R...H55L
With fan	Not Available	Not Available	Not Available

\* Conditions may apply. Please ask your Sales representative for further details.

\*\* Refer to specific heatsink datasheet for further details on heatsink characteristics and assemblies.

# Solid state relays accessories

## Thru wall mount heatsinks for solid state relays

### Types

**RHS11267D**

**RHS30040D**

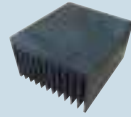

Dimensions HxWxD (mm)  
(SSR not included)

112 x 125 x 67

300 x 200 x 40

Description

Heatsink for max. 3x 1-phase RG series or 1x 1-phase RA, RD, RM, RAM, RS series

Heatsink for max. 12x 1-phase RG series or 8x 1-phase RA, RD, RM, RAM, RS series

### Thermal resistance\*\*

Without fan

0.54°C/W (>150 W)

0.40°C/W (>180 W)

With fan

Not Available

Not Available

### Selection guide for heatsink assemblies\*

Without fan

**R...H78**

**R...H57**

With fan

Not Available

Not Available

## Panel mount heatsinks for solid state relays

### Types

**RHS5050D**

**RHS38AD**

**RHS5840D**

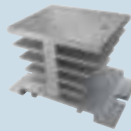

Dimensions WxHxD (mm)  
(SSR not included)

80 x 50 x 51

46 x 76 x 33

81 x 100 x 40

Description

Heatsink for 1x 1-phase RA, RD, RM, RAM, RS series

Heatsink for 1x 1-phase RA, RD, RM, RAM, RS series

Heatsink for max. 3x 1-phase RG series, 1x 1-phase RA, RD, RM, RAM, RS series

### Thermal resistance\*\*

Without fan

3.50°C/W (>25 W)

2.85°C/W (>40 W)

1.80°C/W (>60 W)

With fan

Not available

Not available

Not available

### Selection guide for heatsink assemblies\*

Without fan

**R...H60**

**R...H53**

**R...H48**

With fan

Not available

Not available

Not available

### Types

**RHS10067D**

**RHS10067LD**

**RHS320**

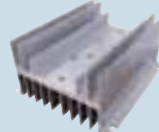

Dimensions WxHxD (mm)  
(SSR not included)

121 x 76 x 67

121 x 140 x 67

240 x 100 x 93

Description

Heatsink for 1x 1-phase RA, RD, RM, RAM, RS series

Heatsink for 2x 1-phase RA, RD, RM, RAM, RS and RG series

Heatsink for 1x 3-phase RZ3 series, max. 3x 1-phase RA, RD, RM, RAM, RS and RG series

### Thermal resistance\*\*

Without fan

1.70°C/W (>20 W)

0.88°C/W (>80 W)

0.40°C/W (>120 W)

With fan

Not available

Not available

Not available

### Selection guide for heatsink assemblies\*

Without fan

**R...H58**

**R...H58L**

**R...H13**

With fan

Not available



Not available

Not available

\* Conditions may apply. Please ask your Sales representative for further details.  
\*\* Refer to specific heatsink datasheet for further details on heatsink characteristics and assemblies.

# Soft starters

## Scroll Compressor soft starters

Types	RSBS	RSBD & RSBT (45 mm)	RSBD & RSBT (120 mm)
Soft starting of 1-Phase (RSBS) and 3-phase (RSBD, RSBT) scroll compressors			
Dimensions (mm)	60.4* x 137 x 81.4	81 x 45 x 125 [RSBT..V11../V51..] 97.5 x 45 x 125 [RSBT..V21../V61..] 106 x 45 x 125 [RSBD..V51../V61..]	150 x 120 x 170
Features	Internally bypassed, Current Limit start Optional auxiliary relay output (Option V22), HP algorithm for high pressure starts	Compact 2- (RSBD) and 3- (RSBT) phase controlled soft starter for scroll compressors. Patented auto-adapt function for reduction of inrush current. Current balancing strategy on RSBD models. No user settings required HP algorithm optimised for multi-compressor systems	Patented Auto-adaptive algorithm Two - (RSBD) and Three phase (RSBT) Controlled versions Internally bypassed 2 Output relays for alarms and top of ramp indication Serial communication for energy variables, alarms, start/stop (RSB...CVC models)
<b>Control specifications</b>			
Control input range	230 VAC	Option E: 110 - 400 VAC [RSBD40../RSBT] Option F: 24 VAC / DC [RSBD40..]	24 VAC/DC & 110-400 VAC
Controlled phases	1	2 [RSBD40..] 3 [RSBT....]	2 [RSBD48..CV..] 3 [RSBT48..CV..]
<b>Output specifications</b>			
Rated operational current (Ie)	25 A [RSBS2325..] 32 A [RSBS2332..]	12/16/25/32/37/45 A [RSBD40..] 16/25/32 A [RSBT..]	55A [RSB.4855CV..] 70A [RSB.4870CV..] 95A [RSB.4895CV..]
Operational voltage	230 VAC (-15%, +10%)	RSBD40: 220 - 400 VAC (-15%, +10%) RSBT22: 220 VAC (-15%, +10%) RSBT40: 400 VAC (-15%, +10%)	220 - 480 VAC (-15%, +10%)
Number of starts per hour	12 (evenly distributed)	12 (evenly distributed)	12 (evenly distributed)
Assigned compressor rating @400 V	<b>RSBS2325... / RSBS2332...****</b> 3.7 kW (5 HP) / 4 kW (5 HP)	<b>RSBD4016/RSBD4025/RSBD4032/ RSBD4037/RSBD4050</b> 5.5kW(5HP)/7.5kW(7.5HP)/11kW(10HP)/15kW (15HP)/18.5kW(20HP)/22kW(25HP) <b>RSBT..16/RSBT..25/RSBT..32</b> 7.5kW (7.5HP)/11.0kW(10HP)/15.0kW(15HP)	<b>RSB.4855CV../ RSB.4870CV../ RSB.4895CV..</b> 22 kW (30 HP) / 30 kW (40 HP) / 45 kW (50 HP)
<b>General specifications</b>			
Internally bypassed	Yes	Yes	Yes
Operational frequency	50/60 Hz ±10%	50/60 Hz +/- 10 Hz	50/60 Hz +/- 10 Hz
Ramp up/Ramp down	< 600ms/0s	<1s/0s	<1s/0s
Default Current limit	40 Arms [RSBS2325..V2..] 45 Arms [RSBS2332..V2..]	3.5xIe [RSBD40..] 40Arms [RSBT..16]/90Arms [RSBT..25]/ 110Arms [RSBT..32]	192.5 Arms [RSB.4855CV..] 245.0 Arms [RSB.4870CV..] 332.5 Arms [RSB.4895CV..]
Operating temperature	-20°C to +65°C (-4°F to +149°F)	RSBD/RSBT..16: -20°C to 60°C (-4°F to +140°F) RSBT..25: -20°C to 55°C (-4°F to +131°F) RSBT..32: -20°C to 50°C (-4°F to +122°F)	-20°C to +60°C (-4°F to +140°F)
Storage temperature	-30°C to +70°C (-22°F to +158°F)	-40°C to +80°C (-40°F to +176°F)	-40°C to +85°C (-40°F to +185°F)
Wrong Phase sequence indication	N/A	Yes	Yes
Degree of Protection	IP 20	IP 20	IP 20 (Housing) / IP 10 (Terminals)
Approvals	CE - UL - cUL	RSBD: CE - cULus - CCC RSBT: CE - cULus** - VDE***	CE - UL - cUL

\* For RSBS23...V22..., auxiliary terminal is 10.5mm protruding

\*\* For options V50/V51/V61

\*\*\* Up to 15 AAC (Up to 32 AAC for RSBT..HPV models only)

\*\*\*\* Assigned compressor rating @ 230 V

# Soft starters

## Centrifugal pump soft starters

### Types

#### RSWT...V00/V10

#### RSWT...V01./V11.

Soft-starters with dedicated, self-learning algorithm for centrifugal pumps.



Dimensions (mm)

RSWT4012/RSWT4016: 130 x 45 x 125  
RSWT4025: 157 x 45 x 125

DIN mount: 180 x 75 x 170  
Panel mount: 177 x 75 x 206

Features

Three phase controlled, internally bypassed. Self-learning algorithm dedicated to centrifugal pumps. RSWT..V00 version - 1-knob adjustment for ramp-up and ramp-down. RSWT..V10 version - Integrated overload protection (Class 10). RSWT40 versions - internally supplied.

Three phase controlled and internally bypassed. RSWT..V01. versions with PTC input protection. RSWT..V11.versions with integrated overload protection, PTC i/p, remote alarm reset. RSWT40 versions - internally supplied. 3 output relays for alarm, top of ramp and run indication.

### Control specifications

Control input range	Option E: 110 - 400 VAC Option F: 24 VAC/DC Option G: 100 - 240 VAC [RSWT60..]	Option E: 110 - 400 VAC [RSWT40..] Option F: 24 VAC/DC [RSWT40....] Option G: 100 - 240 VAC [RSWT60..]
Controlled phases	3	3

### Output specifications

Rated operational current AC 53b	12/16/25 A	32/37/45/55 A
Operational voltage	RSWT40: 220 - 400 VAC (-15%, +10%) RSWT60: 220 - 600 VAC (-15%, +10%)	RSWT40: 220 - 400 VAC (-15%, +10%) RSWT60: 220 - 600 VAC (-15%, +10%)
Number of starts per hour @40°C	20	20
Assigned motor rating @ 400 V	RSWTxx12: 5.5 kW (5HP) RSWTxx16: 7.5 kW (7.5HP) RSWTxx25: 11 kW (10HP)	RSWTxx32: 15kW (20HP) RSWTxx37: 18.5kW (25HP) RSWTxx45: 22kW (30HP) RSWTxx55: 25kW (35HP)



### General specifications

Internally bypassed	Yes	Yes
Operational frequency	50/60 Hz +/- 10%	50/60 Hz +/- 10%
Ramp up/Ramp down	RSWT40...V00: 1 - 20s RSWTxx...V10: 1-20s/0-20s	RSWT40...V010/V011: 1 - 20s RSWTxx...V110/V111: 1-20s/0-20s
Initial torque	Self-adjusted by RSWT	Self-adjusted by RSWT
Operating temperature	-20°C to 60°C (-4°F to +140°F)	-20°C to 60°C (-4°F to +140°F)
Storage temperature	-40°C to +80°C (-40°F to +176°F)	-40°C to +80°C (-40°F to +176°F)
Integrated overload protection	RSWT40...V00: No RSWTxx...V10: Yes	RSWT40...V010/V011: No RSWTxx...V110/V111: Yes
Degree of Protection	IP 20	IP 20 (control circuit) IP 10 (power terminals)
Approvals	CE - cULus - (CCC - pending)	CE - cULus - (CCC - pending)

xx = 40 or 60

# Soft starters

## Motor control - Soft start and stop

Types	RSHR 3-Phase	RSGD	RSDR
Soft starting and stopping of 3-phase motors. Starting / stopping time and initial torque can be independently adjusted			
Dimensions (mm)	158.5 x 90 x 90	106 x 45 x 125 [RSGD..12.. - RSGD..32..] 150 x 45 x 132 [RSGD..37.. - RSGD..45..]	RSDR40055B: 120.5 x 135 x 136 RSDR...66B - 97B: 145.5 x 203 x 167 RSDR..132B - 195B: 155.0 x 203 x 165 RSDR..230B - 500B: 196.0 x 204 x 320
Features	Three phase controlled. In Line or In Delta (6-wire) connection. Wrong Phase sequence detection. Motor PTC protection. Phase Loss Detection	Compact two phase controlled general purpose soft starter. Self-learning algorithm for better current balancing. Improved current reduction capability. Optional alarm and top of ramp relay output	Rotary knobs to adjust start/stop/initial torque parameters. Internally bypassed. Ramp-up/Ramp-down time up to 30s

### Control specifications

Control input range	24-550 VAC/DC (Option "C") 24-600 VAC/DC (Option "D")	Option E: 110 - 400 VAC [RSGD40..] Option F: 24 VAC/DC [RSGD40..] Option G: 100 - 240 VAC [RSGD60..]	24 VDC / 110 VAC (externally supplied)
Controlled phases	3	2	2



### Output specifications

Rated operational current AC 53b	25 A [RSHR..25...] 32 A [RSHR..32...]	12/16/25/32/37/45 A	55/ 66/ 80/ 97/ 132/ 160/ 195/ 230/ 280/ 350/ 430/ 500
Operational voltage	127/220 VAC [RSHR22..] 230/400 VAC [RSHR40..] 277/480 VAC [RSHR48..] 346/600 VAC [RSHR60..] 220-480 VAC [RSHRM ] 400-480 VAC [RSHRM]	RSGD40: 220 - 400 VAC (-15%, +10%) RSGD60: 220 - 600 VAC (-15%, +10%)	RSDR40: 230 - 460 VAC (-15%, +10%)
Number of starts per hour @40°C	7 [RSHR2225.../RSHR4025...] 3 [RSHR4825.../RSHR6025.../RSHRM] 50 [RSHR..32...]	20: [RSGD..12/RSGD..16/RSGD..25] 10: [RSGD..32/RSGD..37/RSGD..45]	10 for (light loads) 5 for (Heavy loads)
Assigned motor rating @ 400 V	In Line Connection/In Delta Connection <b>RSHR4025CV..</b> 11 kW [10 HP] / 20 kW [20 HP] <b>RSHR4032CV..</b> 15 kW [20 HP] / 22kW [30 HP]	<b>RSGDxx12/RSGDxx16/ RSGDxx25</b> 3 kW (3 HP) / 4 kW (5 HP) / 5.5 kW (7.5 HP) 5.5 kW (5.0 HP) / 7.5 kW (7.5 HP) / 11 kW (10 HP) <b>RSGDxx32/RSGDxx37/ RSGDxx45</b> 9 kW (10 HP) / 9kW (10 HP) / 11 kW (15 HP) 15 kW (15 HP) / 18.5 kW (20 HP) / 22 kW (25 HP)	RSDR40055B (30 kW/42 HP) RSDR40066B (37 kW/54 HP) RSDR40080B (45 kW/60 HP) RSDR40097B (55 kW/75 HP) RSDR40132B (75 kW/110 HP) RSDR40160B (90 kW/130 HP) RSDR40195B (110 kW/160 HP) RSDR40230B (132 kW/190 HP) RSDR40280B (160 kW/230 HP) RSDR40350B (200 kW/290 HP) RSDR40430B (250 kW/350HP) RSDR40500B (280 kW/400 HP)

### General specifications

Internally bypassed	No	Yes	Yes
Operational frequency	50/60 Hz ±10%	50/60 Hz ± 10%	50/60 Hz +/- 2 Hz
Ramp up/Ramp down	1-10s / 0-30s; 0-1s / 0-1s [RSHR...V38]	1 - 20s/0 - 20s	1 - 30s/0 - 30s
Initial torque	0-70%	0 - 85%	30 - 100%
Operating temperature	-20°C to +60°C (-4°F to +140°F)	-20°C to 60°C (-4°F to +140°F)	0°C to 60°C (+32°F to +140°F)
Storage temperature	-50°C to +85°C (-58°F to +185°F)	-40°C to +80°C (-40°F to +176°F)	-25°C to +60°C (-13°F to +140°F)
Wrong Phase sequence indication	Yes	Yes	No
Degree of Protection	IP 20	IP 20	IP 20 - RSDR40055B up to RSDR40097B IP 00 - RSDR40132B up to RSDR40500B
Approvals	CE - UL - cUL - CCC	CE - cULus - CCC	CE - UL





# Soft starters

	<b>Proportional controller</b>	<b>Reversing</b>
<b>Types</b>	<b>RSC..AA..+RSO...</b>	<b>RR2A</b>
Phase angle control of 3-phase motors (AC53a) and heaters (AC51a). Reversing motor relay (RR..)		
Dimensions (mm)	65 x 103 x 74	41 x 103 x 74
Features	Proportional output for motor/heater control according to user controlled analogue input	Reversing with interlock, optoisolation 2-pole change-over, built-in transient overvoltage protection, interlocking reversing, LED status indication
<b>Control specifications</b>		
Control input range	0-20 mA (A-input) 4-20 mA (B-input)	10-40 VDC
Max. input current	20 mA	20 mA
Control supply	10 - 32 VDC	-
Max. supply current	180 mA	-
<b>Output specifications</b>		
Rated operational current		
AC 51a	16 Arms [RSO..10] 25 Arms [RSO..25] 50 Arms [RSO..50] 90 Arms [RSO..90] 110 Arms [RSO..110]	-
AC 53a	5 Arms [RSO..25] 15 Arms [RSO..50] 30 Arms [RSO..90] 40 Arms [RSO..110]	5 Arms [RR2A40D150/RR2A48D220] 11 Arms [RR2A40D400/RR2A48D550]
Operational voltage	150-250 Vrms [RSO22..] 220-420 Vrms [RSO40..] 400-510 Vrms [RSO48..] 400-625 Vrms [RSO60..]	400 Vrms [RR2A40D...] 480 Vrms [RR2A48D...]
<b>General specifications</b>		
Connections	Screw type with clamp	Screw type with clamp
Operating temperature	-20°C to +70°C	-20°C to +80°C
Storage temperature	-40°C to +100°C	-40°C to +100°C
Approvals/Marks	CE - UL - CSA - CCC	CE - UL - cUL - CCC
<b>Reference</b>		
	Control module	5 A
	<b>RSC-AAM60</b>	<b>RR2A40D150</b> (1.5 kW)
	Output module: 400 VAC	<b>RR2A40D400</b> (4.0 kW)
	25 A: <b>RSO4025</b> (4 kW*)	11 A
	50 A: <b>RSO4050</b> (11 kW*)	<b>RR2A48D220</b> (2.2 kW)
	90 A: <b>RSO4090</b> (15 kW*)	<b>RR2A48D550</b> (5.5 kW)
	110 A: <b>RSO40110</b> (22 kW*)	

\* Output module can be 200, 400, 480, 600 VAC  
 \* Correct heatsink assembly required. For further details please consult datasheet.  
 \*\* Applicable when device is mounted to heatsink type RHS301





# Motor protection relays

## DMPU series

Types	Main module	Measurement module (5A)	Measurement module (65A)	I/O module
				
Dimensions HxWxD (mm)	35.5 x 90 x 63.2	53.5 x 90 x 63.2	53.5 x 90 x 92	17.5 x 90 x 63.2
Features	Motor start/stop, reverse, start/delta, ANSI motor protection functions, remote control and management, warning, dataloggers	3-phase voltage and split-core current measurement	3-phase voltage and pass through current measurement	Connected to DMPUC-PRB or DMPUC-MTB adds 2 inputs and 2 outputs to the system. Up to 10 modules can be used
<b>Technical specifications</b>				
Power supply	24 VDC $\pm$ 20%	24 VDC from the main module	24 VDC from the main module	24 VDC from the main module
Inputs	3, configurable as contact or temperature	3-phase voltage: 100 to 690 V 3-phase current: 5 A (for higher current use CTD currents transformers series)	3-phase voltage: 100 to 690 V 3-phase current: up to 65 A	2, configurable as contact or temperature
Outputs		2 x SPST relay	2 x SPST relay	2 x SPST relay
Communication	Profibus DPV1 (DMPUC-PRB), Modbus TCP/IP (DMPUC-MTB), Modbus RTU (all)	Via cable to the main module	Via cable to the main module	Plugged in to the main module
<b>General specifications</b>				
Operating temperature	-25°C to +55°C (-13°F to 131°F)	-25°C to +55°C (-13°F to 131°F)	-25°C to +55°C (-13°F to 131°F)	-25°C to +55°C (-13°F to 131°F)
Degree of protection	IP 20	IP 20	IP 20	IP 20
Mounting	DIN-rail	DIN-rail	DIN-rail	DIN-rail
Approvals	CE - cULus listed - C-TIC	CE - cULus listed - C-TIC	CE, cULus listed, C-TIC	CE - cULus listed - C-TIC
<b>References</b>				
	DMPUC-PRB DMPUC-MTB	DMPUC-05	DMPUC-65	DMPUC-R2

# Motor protection relays

## DMPU series

Types	Operator interface	Earth leakage module	Core balance transformers	Programming software
				
Dimensions HxWxD (mm)	96 x 48 x 88.5	17.5 x 90 x 63.2	Hole Ø 35, 70, 120 or 210	
Features	Provides 2x8 characters lines display and 4 fully programmable keys	Connected to DMPUC-PRB or DMPUC-MTB adds direct earth leakage measurement and protection according to EN 60947-2. Ranges: 30 mA to 30 A	Core balance transformers for DMPUC-EL	Set parameters, program the control and monitoring functions of the system, monitor data, download dataloggers. Program operator interface pages and key functions
<b>Technical specifications</b>				
Power supply	24 VDC ±20%	24 VDC from the main module	None	
Inputs		Earth leakage, for transformers 250/1 to 1000/1, 3 as contact		Motor data, desired functions
Outputs		1 x SPST relay dedicated to earth leakage alarm		Configuration file, dataloggers in Excel format files
Communication	RS485 Modbus RTU ports	Plugged in to the main module		Using Modbus RTU or TCP/IP port of the main module
<b>General specifications</b>				
Operating temperature	-25°C to +60°C (-13°F to 140°F)	-25°C to +55°C (-13°F to 131°F)		
Degree of protection	Front: IP 65 Connections: IP 20	IP 20		
Mounting	Front panel	DIN-rail	Back panel	Windows XP, Windows Vista, Windows 7
Approvals	cULus listed	CE - cULus - C-TIC (with CTG)	CE - cULus - C-TIC (with DMPUC-EL)	
<b>References</b>				
	DMPUC-HMI	DMPUC-EL	CTG035 CTG070 CTG120 CTG210	DMPU-PS DMPU-PSHMI



# Variable speed drives

## VariFlex<sup>3</sup> variable speed drives - RVLf series

## Accessories

Types	Size A	Size B	Braking unit
Drives, Inverters			

Dimensions HxWxD (mm)	141 x 72 x 139	144 x 118 x 147	132 x 77 x 130.5
-----------------------	----------------	-----------------	------------------

Features	V/F control Soft PWM. 3 modes selectable, 32 bit Processor, 150% torque at 3Hz, RJ45 Interface, built-in EMI filter, Parameter Lock & Parameter access code, Auto sequencer 8 programmable presets for frequency & run duration, Individual Accel/decel for auto sequencer preset speeds, Five Multi function Inputs, Output relay programmable NO or NC	V/F control Soft PWM. 3 modes selectable, 32 bit Processor, 150% torque at 3Hz, RJ45 Interface, built-in EMI filter, Parameter Lock & Parameter access code, Auto sequencer 8 programmable presets for frequency & run duration, Individual Accel/decel for auto sequencer preset speeds, Five Multi function Inputs, Output relay programmable NO or NC	External braking unit for RVEF frequency drives, with 240 VAC and 480 VAC inverter voltage. Applicable motor rated capacity up to 2.2 kW
----------	--	--	--

### Technical specifications

AC supply voltage	1-ph, 200-240 VAC; 3-ph, 380-480 VAC;	1-ph, 200-240 VAC; 3-ph, 380-480 VAC;	
AC supply frequency	50/60 Hz	50/60 Hz	
Output voltage	3-ph: 200-240 VCA 3-ph: 380-480 VCA	3-ph: 200-240 VCA 3-ph: 380-480 VCA	
Output frequency	0.01~650.00 Hz	0.01~650.00 Hz	
100% RMS output current	1.8 A [RVLFA...020] 2.6 A [RVLFA...040] 4.3 A [RVLFA...075]	7.5 A [RVLFB120150] 10.5 A [RVLFB120220] 4.3 A [RVLFB340075] 7.5 A [RVLFB340150] 10.5 A [RVLFB340220]	
Input displacement factor (cos φ)	> 0.97	> 0.97	

### General specifications

Operating temperature	-10°C to +50°C	-10°C to +50°C	-10°C to +50°C
Storage temperature	-20°C to +60°C	-20°C to +60°C	-20°C to +70°C
Degree of protection	IP 20	IP 20	IP 20
Power connections	Screw terminals	Screw terminals	
Control connections	Screw terminals	Screw terminals	
Drive connections			Screw terminals
Mounting	DIN-rail or panel mounting	DIN-rail or panel mounting	DIN-rail or panel mounting
Integrated cooling fan	No	Yes (1,5-2,2 kW)	
Switching frequency	1 to 16 kHz	1 to 16 kHz	
Approvals	CE - cULus	CE - cULus	CE - cULus

### Braking unit





Rate discharge current	240 V : 7.5 A	480 V : 3 A
Max. discharge current	240 V : 15 A	480 V : 7.5 A

### References

200 - 240 VAC, 1-phase	<b>RVLFA120020F</b> (0.20 kW-0.25 HP) <b>RVLFA120040F</b> (0.40 kW-0.50 HP) <b>RVLFA120075F</b> (0.75 kW-1.00 HP)	<b>RVLFB120150F</b> (1.50 kW-2.00 HP) <b>RVLFB120220F</b> (2.20 kW-3.00 HP)	<b>RVFTBU230</b>
380 - 480 VAC, 3-phase		<b>RVLFB340075F</b> (0.75 kW-1.00 HP) <b>RVLFB340150F</b> (1.50 kW-2.00 HP) <b>RVLFB340220F</b> (2.20 kW-3.00 HP)	<b>RVFTBU480</b>

# Variable speed drives

## VariFlex<sup>2</sup> variable speed drives - RVDF series

Types	Size A IP20	Size B IP20	Size A IP65	Size B IP65
Drives, Inverters				
Dimensions HxWxD (mm)	132 x 72 x 118	140 x 118 x 171	205 x 134 x 174	295 x 232 x 181
Features	Maximum overload of 150% for 60 s, conforms to EN61800-3 for the 2 <sup>nd</sup> environment. Parameters settings by keypad	Maximum overload of 150% for 60 s, conforms to EN61800-3 for the 2 <sup>nd</sup> environment. Parameters settings by keypad	Maximum overload of 150% for 60 s, conforms to EN61800-3 for the 2 <sup>nd</sup> environment. Parameters settings by keypad. IP65 models with power switch, reverse / forward switch and potentiometer	Maximum overload of 150% for 60 s, conforms to EN61800-3 for the 2 <sup>nd</sup> environment. Parameters settings by keypad. IP65 models with power switch, reverse / forward switch and potentiometer

### Technical specifications

AC supply voltage	1-ph, 100-120 VAC 1-ph, 200-240 VAC	1-ph, 200-240 VAC 3-ph, 380-480 VAC	1-ph, 200-240 VAC	1-ph, 200-240 VAC 3-ph, 380-480 VAC
AC supply frequency	50/60 Hz	50/60 Hz	50/60 Hz	50/60 Hz
Output voltage	3-ph, 0-240 VAC	3-ph, 0-240 VAC 3-ph, 0-480 VAC	3-ph, 0-240 VAC	3-ph, 0-240 VAC 3-ph, 0-480 VAC
Output frequency	0-200 Hz	0-200 Hz	0-200 Hz	0-200 Hz
100% RMS output current	1.4 A [RVDFFA...020] 2.3 A [RVDFFA...040] 4.2 A [RVDFFA...075]	7.5 A [RVDFB1...150] 10.5 A [RVDFB1...220] 2.3 A [RVDFB3...075] 3.8 A [RVDFB3...150] 5.2 A [RVDFB3...220]	1.4 A [RVDFFA...020] 2.3 A [RVDFFA...040] 4.2 A [RVDFFA...075]	7.5 A [RVDFB1...150] 10.5 A [RVDFB1...220] 2.3 A [RVDFB3...075] 3.8 A [RVDFB3...150] 5.2 A [RVDFB3...220]
Input displacement factor (cos φ)	> 0.97	> 0.97	> 0.97	> 0.97

### General specifications



Operating temperature	-10°C to +50°C	-10°C to +50°C	-10°C to +50°C	-10°C to +50°C
Degree of protection	IP 20	IP 20	IP 65	IP 65
Power connections	Screw terminals	Screw terminals	Screw terminals	Screw terminals
Control connections	Screw terminals	Screw terminals	Screw terminals	Screw terminals
Mounting	DIN-rail or panel mounting	DIN-rail or panel mounting	Panel mounting	Panel mounting
Integrated cooling fan	yes	yes	yes	yes
Switching frequency	4 to 16 kHz	4 to 16 kHz	4 to 16 kHz	4 to 16 kHz
Approvals	CE - cULus	CE - cULus	CE - cULus	CE - cULus

### References

100-120 VAC, 1-phase	RVDFFA110020 RVDFFA110040 RVDFFA110075			
200-240 VAC, 1-phase	RVDFFA120020F RVDFFA120040F RVDFFA120075F	RVDFB120150F RVDFB120220F	RVDFFA120020FES RVDFFA120040FES RVDFFA120075FES	RVDFB120150FES RVDFB120220FES
380-480 VAC, 3-phase		RVDFB340075F RVDFB340150F RVDFB340220F		RVDFB340075FES RVDFB340150FES RVDFB340220FES

# Variable speed drives

## VariFlex<sup>2</sup> variable speed drives - RVCF series

Types	Size A	Size B	Size C
Drives, Inverters			
Dimensions HxWxD (mm)	163 x 90 x 147	187.1 x 128 x 148	260 x 186 x 195
Features	Maximum overload of 150% of rated current for 60s, conforms to EN 61800-3 for the 2 <sup>nd</sup> environment, parameters accessible via keypad, knob and PC, optional serial communications, optional copy card for drive-to-drive parameter transfer and storage and optional keypad extension cable. Built-in PLC function and PID control	Maximum overload of 150% of rated current for 60s, conforms to EN 61800-3 for the 2 <sup>nd</sup> environment, parameters accessible via keypad, knob and PC, optional serial communications, optional copy card for drive-to-drive parameter transfer and storage and optional keypad extension cable. Built-in PLC function and PID control	Maximum overload of 150% of rated current for 60s, conforms to EN 61800-3 for the 2 <sup>nd</sup> environment, parameters accessible via keypad, knob and PC, optional serial communications, optional copy card for drive-to-drive parameter transfer and storage and optional keypad extension cable. Built-in PLC function and PID control

### Technical specifications

AC supply voltage	3-ph, 380-480 VAC	3-ph, 200-240 VAC 3-ph, 380-480 VAC	3-ph, 200-240 VAC 3-ph, 380-480 VAC
AC supply frequency	50/60 Hz	50/60 Hz	50/60 Hz
Output voltage	3-ph, 0-480 V	3-ph, 0-240 V 3-ph, 0-480 V	3-ph, 0-240 V 3-ph, 0-480 V
Output frequency	0-650 Hz	0-650 Hz	0-650 Hz
100% RMS output current	2.3A [RVCF3400075] 3.8A [RVCF3400150]	17.5A [RVCFB3200370] 5.2A [RVCFB3400220] 8.8A [RVCFB3400370]	26A [RVCF3200550] 35A [RVCF3200750] 13A [RVCF3400550] 17.5A [RVCF3400750] 25A [RVCF3401100]
Input displacement factor (cos φ)	> 0.97	> 0.97	> 0.97

### General specifications

Operating temperature	-10°C to +50°C	-10°C to +50°C	-10°C to +50°C
Storage temperature	-20°C to +60°C	-20°C to +60°C	-20°C to +60°C
Degree of protection	IP 20	IP 20	IP 20
Power connections	Screw terminals	Screw terminals	Screw terminals
Control connections	Screw terminals	Screw terminals	Screw terminals
Mounting	DIN-rail or panel mounting	DIN-rail or panel mounting	Panel mounting
Integrated cooling fan	yes	yes	yes
Switching frequency	2 to 16 kHz	2 to 16 kHz	2 to 16 kHz
Approvals	CE - cULus	CE - cULus	CE - cULus

### References

220-240 VAC, 3-phase		<b>RVCFB3200370</b> (3.70 kW - 5.00 HP)	<b>RVCF3200550</b> (5.50 kW - 7.50 HP) <b>RVCF3200750</b> (7.50 kW - 10.0 HP)
380-480 VAC, 3-phase	<b>RVCF3400075(F)</b> (0.75 kW - 1.00 HP) <b>RVCF3400150(F)</b> (1.50 kW - 2.00 HP)	<b>RVCFB3400220(F)</b> (2.20 kW - 3.00 HP) <b>RVCFB3400370(F)</b> (3.70 kW - 5.00 HP)	<b>RVCF3400550(F)</b> (5.50 kW - 7.50 HP) <b>RVCF3400750(F)</b> (7.50 kW - 10.0 HP) <b>RVCF3401100(F)</b> (11.0 kW - 15.0 HP)

(F): equipped with built-in filter

# Variable speed drives

## VariFlex<sup>2</sup> variable speed drives - RVCF series

Types	Size D	Size E
Drives, Inverters		
Dimensions HxWxD (mm)	360 x 265 x 247.5	553 x 269 x 303.6

Features	Size D	Size E
	<p>Maximum overload of 150% of rated current for 60s, conforms to EN 61800-3 for the 2<sup>nd</sup> environment, parameters accessible via keypad, knob and PC, optional serial communications, optional copy card for drive-to-drive parameter transfer and storage and optional keypad extension cable.</p> <p>Built-in PLC function and PID control</p>	<p>Maximum overload of 150% of rated current for 60s, conforms to EN 61800-3 for the 2<sup>nd</sup> environment, parameters accessible via keypad, knob and PC, optional serial communications, optional copy card for drive-to-drive parameter transfer and storage and optional keypad extension cable.</p> <p>Built-in PLC function and PID control</p>

Technical specifications		
AC supply voltage	3-ph, 200-240 VAC 3-ph, 380-480 VAC	3-ph, 200-240 VAC 3-ph, 380-480 VAC
AC supply frequency	50/60 Hz	50/60 Hz
Output voltage	3-ph, 0-240 V 3-ph, 0-480 V	3-ph, 0-240 V 3-ph, 0-480 V
Output frequency	0-650 Hz	0-650 Hz
100% RMS output current	48 A [RVCFD3201100] 64 A [RVCFD3201500] 80 A [RVCFD3201850] 32 A [RVCFD3401500] 40 A [RVCFD3401850] 48 A [RVCFD3402200]	96 A [RVCFE3202200] 130 A [RVCFE3203000] 64 A [RVCFE3403000] 80 A [RVCFE3403700]
Input displacement factor (cos φ)	> 0.97	> 0.97

General specifications		
Operating temperature	-10°C to +50°C	-10°C to +50°C
Storage temperature	-20°C to +60°C	-20°C to +60°C
Degree of protection	IP 20	IP 00
Power connections	Screw terminals	Screw terminals
Control connections	Screw terminals	Screw terminals
Mounting	Panel mounting	Panel mounting
Integrated cooling fan	yes	yes
Switching frequency	2 to 16 kHz	2 to 16 kHz
Approvals	CE - cULus	CE - cULus

References		
220-240 VAC, 3-phase	<b>RVCFD3201100</b> (11.0 kW - 15.0 HP) <b>RVCFD3201500</b> (15.0 kW - 20.0 HP) <b>RVCFD3201850</b> (18.5 kW - 25.0 HP)	<b>RVCFE3202200</b> (15.0 kW - 20.0 HP)
380-480 VAC, 3-phase	<b>RVCFD3401500</b> (15.0 kW - 20.0 HP) <b>RVCFD3401850</b> (18.5 kW - 25.0 HP) <b>RVCFD3402200</b> (22.0 kW - 30.0 HP)	

# Limit switches - Safety hinge

## Head types

### Safety hinge

### Safety hinge

### Safety hinge



## Family: PS38H

	PS38H M12 connector	PS38H 2m cable	PS38H 2m cable back output
Material body	Thermoplastic	Thermoplastic	Thermoplastic
Dimensions WxHxD (mm)	60 x 110 x 15	60 x 110 x 15	60 x 110 x 15

















## References contact block

Slow action T22: 2NO + 2NC	<b>PS38H-IT2205-T01</b>	<b>PS38H-CT2205-T01</b>	<b>PS38H-CT2205-T02</b>
Slow action T13: 1NO + 3NC	<b>PS38H-IT1305-T01</b>	<b>PS38H-CT1305-T01</b>	<b>PS38H-CT1305-T02</b>

## General specifications (for all types)

Conformance	IEC 947-5-1 and European EN 60947-5-1 standards.Safety system of machinery up to SIL 3 or PLe according to EN ISO 13849-1.	IEC 947-5-1 and European EN 60947-5-1 standards.Safety system of machinery up to SIL 3 or PLe according to EN ISO 13849-1.	IEC 947-5-1 and European EN 60947-5-1 standards.Safety system of machinery up to SIL 3 or PLe according to EN ISO 13849-1.
Air temperature near the device	Operation - 20°C to + 80°C Storage - 20°C to + 80°C	Operation - 20°C to + 80°C Storage - 20°C to + 80°C	Operation - 20°C to + 80°C Storage - 20°C to + 80°C
Degree of protection	IP 67	IP 67	IP 67
Mechanical durability	1,000,000 operations	1,000,000 operations	1,000,000 operations
Operation frequency	1,200 cycles/h	1,200 cycles/h	1,200 cycles/h
B10d	2,000,000 cycles	2,000,000 cycles	2,000,000 cycles
Positive opening operation (according to IEC 947-5-1)	All NC contacts are positive opening operation (min. actuating torque 0.5 Nm)	All NC contacts are positive opening operation (min. actuating torque 0.5 Nm)	All NC contacts are positive opening operation (min. actuating torque 0.5 Nm)
Rated insulation voltage Ui	30 V	400 V	400 V
Protection against electrical shocks (according to IEC 536)	Class II	Class II	Class II
Thermal current Ith	2 A	4 A	4 A
Rated operational current	24 VDC - 2A	24 - 120 - 250 - 400 VCA 4 A 24 VDC 2A / 125 VDC 0.4 A / 250 VDC 0.3 A	24 - 120 - 250 - 400 VAC 4A 24 VDC 2 A / 125 VDC 0.4 A / 250 VDC 0.3 A
Approvals	CE - UL - CSA	CE - UL - CSA	CE - UL - CSA

## Limit switches - Miniature type

Head Types	PO Plain plunger	PY Nylon roller plunger	P8 Cross nylon roller plunger	RT Ø14 Nylon roller lever
				
Dimensions HxWxD (mm)	35 x 60 x 16 1 m PVC cable	35 x 70 x 16 1 m PVC cable	35 x 70 x 16 1 m PVC cable	35 x 92 x 29.5 1 m PVC cable
<b>PS31M (metal*) References contact block</b>				
Snap 1NO+1NC	⊕ PS31M-CS11PO-M00	⊕ PS31M-CS11PY-M00	⊕ PS31M-CS11P8-M00	⊕ PS31M-CS11RT-M00
Slow 1NO+1NC	⊕ PS31M-CT11PO-M00	⊕ PS31M-CT11PY-M00	⊕ PS31M-CT11P8-M00	⊕ PS31M-CT11RT-M00
				
Dimensions WxHxD (mm)	31.5 x 60 x 16 1 m PVC cable	31.5 x 70 x 16 1 m PVC cable	31.5 x 70 x 16 1 m PVC cable	31.5 x 92 x 29.5 1 m PVC cable
<b>PS21M (metal*) References contact block</b>				
Snap 1NO+1NC	⊕ PS21M-CS11PO-M00	⊕ PS21M-CS11PY-M00	⊕ PS21M-CS11P8-M00	⊕ PS21M-CS11RT-M00
Slow 1NO+1NC	⊕ PS21M-CT11PO-M00	⊕ PS21M-CT11PY-M00	⊕ PS21M-CT11P8-M00	⊕ PS21M-CT11RT-M00
Head Types	Plain plunger with fixing nuts	Roller plunger with fixing nuts	Cross roller plunger with fixing nuts	R1 Adjustable lever with Ø18 nylon roller
				
Dimensions (mm) WxHxD	35 x 74 x 16 1 m PVC cable	35 x 84.8 x 16 1 m PVC cable	35 x 84.8 x 16 1 m PVC cable	35 x 86...158 x 38.9 1 m PVC cable
<b>PS31M (metal*) References contact block</b>				
Snap 1NO+1NC	⊕ PS31M-CS11PO-MOL	⊕ PS31M-CS11PY-MOL	⊕ PS31M-CS11P8-MOL	⊕ PS31M-CS11RT-MOL
Slow 1NO+1NC	⊕ PS31M-CT11PO-MOL	⊕ PS31M-CT11PY-MOL	⊕ PS31M-CT11P8-MOL	⊕ PS31M-CT11RT-MOL
				
Dimensions WxHxD (mm)	31.5 x 74 x 16 1 m PVC cable	31.5 x 84.8 x 16 1 m PVC cable	31.5 x 84.8 x 16 1 m PVC cable	31.5 x 86...158 x 38.9 1 m PVC cable
<b>PS21M (metal*) References contact block</b>				
Snap 1NO+1NC	⊕ PS21M-CS11PO-MOL	⊕ PS21M-CS11PY-MOL	⊕ PS21M-CS11P8-MOL	⊕ PS21M-CS11RT-MOL
Slow 1NO+1NC	⊕ PS21M-CT11PO-MOL	⊕ PS21M-CT11PY-MOL	⊕ PS21M-CT11P8-MOL	⊕ PS21M-CT11RT-MOL
<b>General specifications (for all types)</b>				
Mechanical life	>10 000 000 cycles		Rated thermal current (Ith)	10 A (IEC947-5-1)
Operating frequency	3600 cycles/h		Rated insulation voltage (Ui)	400 VAC (IEC947-5-1)
Operating Speed	1...1500 mm/s		Insulation resistance (500 VDC)	2 MΩ
Rated operating current (Ie)	1.5 A/230 V (Cat. AC15)		Degree of protection	IP 67
	1.1 A/24 V (Cat. DC13)		Approvals	CE - UL (upon request)

\* Also available in thermoplastic (T type)

## Limit switches - Limit type

Head Types	PO Plain plunger	PR Roller plunger	RH Plastic roller plunger	RT Nylon roller lever
------------	---------------------	----------------------	------------------------------	--------------------------



### Family: L

	PS21	PS21	PS21	PS21
	Thermoplastic*	Thermoplastic*	Thermoplastic*	Thermoplastic*
Dimensions WxHxD (mm)	30.3 x 73 x 30	30.3 x 84 x 30	30.3 x 92 x 30	30.3 x 106 x 45

### References contact block

Snap 1NO+1NC	⊕	PS21L-PS11P0-T00	PS21L-PS11PR-T00	PS21L-PS11RH-T00	PS21L-PS11RT-T00
Slow 1NO+1NC	⊕	PS21L-PT11P0-T00	PS21L-PT11PR-T00	PS21L-PT11RH-T00	PS21L-PT11RT-T00
Slow Ov.**1NO+1NC	⊕	PS21L-PO11P0-T00	PS21L-PO11PR-T00	PS21L-PO11RH-T00	PS21L-PO11RT-T00
Slow 2NO		PS21L-PT20P0-T00	PS21L-PT20PR-T00	PS21L-PT20RH-T00	PS21L-PT20RT-T00
Slow 2NC	⊕	PS21L-PT02P0-T00	PS21L-PT02PR-T00	PS21L-PT02RH-T00	PS21L-PT02RT-T00
Snap 2NC	⊕	PS21L-PS02P0-T00	PS21L-PS02PR-T00	PS21L-PS02RH-T00	PS21L-PS02RT-T00



### Family: L

	PS42	PS42	PS42	PS42
	Thermoplastic*	Thermoplastic*	Thermoplastic*	Thermoplastic*
Dimensions HxWxD (mm)	57 x 66 x 33	57 x 77 x 33	57 x 85 x 33	57 x 99 x 45

### References contact block

Snap 1NO+1NC	⊕	PS42L-PS11P0-T00	PS42L-PS11PR-T00	PS42L-PS11RH-T00	PS42L-PS11RT-T00
Slow 1NO+1NC	⊕	PS42L-PT11P0-T00	PS42L-PT11PR-T00	PS42L-PT11RH-T00	PS42L-PT11RT-T00
Slow Ov.**1NO+1NC	⊕	PS42L-PO11P0-T00	PS42L-PO11PR-T00	PS42L-PO11RH-T00	PS42L-PO11RT-T00
Slow 2NO		PS42L-PT20P0-T00	PS42L-PT20PR-T00	PS42L-PT20RH-T00	PS42L-PT20RT-T00
Slow 2NC	⊕	PS42L-PT02P0-T00	PS42L-PT02PR-T00	PS42L-PT02RH-T00	PS42L-PT02RT-T00
Snap 2NC	⊕	PS42L-PS02P0-T00	PS42L-PS02PR-T00	PS42L-PS02RH-T00	PS42L-PS02RT-T00

### General specifications (for all types)

Degree of protection	IP 65 (plastic body) IP 66 (metal body)	Rated operational current	
Rated insulation voltage plastic body	(U <sub>i</sub> )	I <sub>e</sub> /AC-15 230 VAC	3.1 A
according to IEC 60947-1 and EN 60947-1	500 V	I <sub>e</sub> /AC-13 24 VDC	2.8 V
according to UL 508, CSA C22-2 n°14	A 600, Q 600	Electrical durability (according to IEC 60947-5-1 annex C)	
Rated insulation voltage metal body	(U <sub>i</sub> )	max. switching frequency Cycles/h	3600
according to IEC 60947-1 and EN 60947-1	400 V (PS21, PS42)	load factor	0.5
	500 V (PS31, PS43)	Air temperature near the device	
according to UL 508, CSA C22-2 n°14	A 300, Q 300 (PS21, PS42)	during operation	-25 to +70°C
	A 600, Q 600 (PS31, PS43)	for storage	-30 to +80°C
Conventional enclosed thermal voltage (U <sub>imp</sub> )	6 kV	Approvals	CE - UL - CSA

\* also available in metal (Y type)    \*\* Ov.: overlapping travel paths

## Limit switches - Limit type

### Head types

**W1** Adjustable lever with Ø50 rubber roller

**R1** Adjustable lever with Ø18 nylon roller

**BE** Ø18 nylon roller lever

**LW** Stainless steel spring cat whisker



### Family: L

	PS21	PS21	PS21	PS21
	Thermoplastic*	Thermoplastic*	Thermoplastic*	Thermoplastic*
Dimensions WxHxD (mm)	30.3 x (126.5-186.5) x 52	30.3 x (98.5-170.5) x 45.5	30.3 x 114 x 33	30.3 x 188 x 30

### References contact block

Snap 1NO+1NC	⊕	PS21L-PS11W1-T00	PS21L-PS11R1-T00	PS21L-PS11BE-T00	PS21L-PS11LW-T00
Slow 1NO+1NC	⊕	PS21L-PT11W1-T00	PS21L-PT11R1-T00	PS21L-PT11BE-T00	PS21L-PT11LW-T00
Slow Ov.**1NO+1NC	⊕	PS21L-PO11W1-T00	PS21L-PO11R1-T00	PS21L-PO11BE-T00	PS21L-PO11LW-T00
Slow 2NO		PS21L-PT20W1-T00	PS21L-PT20R1-T00	PS21L-PT20BE-T00	PS21L-PT20LW-T00
Slow 2NC	⊕	PS21L-PT02W1-T00	PS21L-PT02R1-T00	PS21L-PT02BE-T00	PS21L-PT02LW-T00
Snap 2NC	⊕	PS21L-PS02W1-T00	PS21L-PS02R1-T00	PS21L-PS02BE-T00	PS21L-PS02LW-T00



### Family: L

	PS42	PS42	PS42	PS42
	Thermoplastic*	Thermoplastic*	Thermoplastic*	Thermoplastic*
Dimensions HxWxD (mm)	57 x (118.5-177) x 33	57 x (91.5-163.5) x 33	57 x 107 x 33	57 x 181 x 45

### References contact block

Snap 1NO+1NC	⊕	PS42L-PS11W1-T00	PS42L-PS11R1-T00	PS42L-PS11BE-T00	PS42L-PS11LW-T00
Slow 1NO+1NC	⊕	PS42L-PT11W1-T00	PS42L-PT11R1-T00	PS42L-PT11BE-T00	PS42L-PT11LW-T00
Slow Ov.**1NO+1NC	⊕	PS42L-PO11W1-T00	PS42L-PO11R1-T00	PS42L-PO11BE-T00	PS42L-PO11LW-T00
Slow 2NO		PS42L-PT20W1-T00	PS42L-PT20R1-T00	PS42L-PT20BE-T00	PS42L-PT20LW-T00
Slow 2NC	⊕	PS42L-PT02W1-T00	PS42L-PT02R1-T00	PS42L-PT02BE-T00	PS42L-PT02LW-T00
Snap 2NC	⊕	PS42L-PS02W1-T00	PS42L-PS02R1-T00	PS42L-PS02BE-T00	PS42L-PS02LW-T00

### General specifications (for all types)

Degree of protection	IP 65 (plastic body) IP 66 (metal body)	Rated operational current	
Rated insulation voltage plastic body	(U <sub>i</sub> )	le/AC-15 230 VAC	3.1 A
according to IEC 60947-1 and EN 60947-1	500 V	le/AC-13 24 VDC	2.8 V
according to UL 508, CSA C22-2 n°14	A 600, Q 600	Electrical durability (according to IEC 60947-5-1 annex C)	
Rated insulation voltage metal body	(U <sub>i</sub> )	max. switching frequency Cycles/h	3600
according to IEC 60947-1 and EN 60947-1	400 V (plastic body)	load factor	0.5
	500 V (PS31, PS43)	Air temperature near the device	
according to UL 508, CSA C22-2 n°14	A 300, Q 300 (PS21, PS42)	during operation	-25 to +70°C
	A 600, Q 600 (PS31, PS43)	for storage	-30 to +80°C
Conventional enclosed thermal voltage (U <sub>imp</sub> )	6 kV	Approvals	CE - UL - CSA

\* also available in metal (M type)

\*\* Ov. : overlapping travel paths



## Limit switches - Limit type

**Head types**      **PO** Plain plunger      **PR** Roller plunger      **RH** Plastic roller lever      **RT** Nylon roller lever



### Family: L

	PS43	PS43	PS43	PS43
	Metal	Metal	Metal	Metal
Dimensions HxWxD (mm)	66 x 102.5 x 43	66 x 115.5 x 43	67 x 129.5 x 43	66 x 128.5 x 61.5

### References contact block

Snap 1NO+1NC	⊕	PS43L-PS11PO-M00	PS43L-PS11PR-M00	PS43L-PS11RH-M00	PS43L-PS11RT-M00
Slow 1NO+1NC	⊕	PS43L-PT11PO-M00	PS43L-PT11PR-M00	PS43L-PT11RH-M00	PS43L-PT11RT-M00
Slow Ov.**1NO+1NC	⊕	PS43L-PO11PO-M00	PS43L-PO11PR-M00	PS43L-PO11RH-M00	PS43L-PO11RT-M00
Slow 2NO		PS43L-PT20PO-M00	PS43L-PT20PR-M00	PS43L-PT20RH-M00	PS43L-PT20RT-M00
Slow 2NC	⊕	PS43L-PT02PO-M00	PS43L-PT02PR-M00	PS43L-PT02RH-M00	PS43L-PT02RT-M00
Snap 2NC	⊕	PS43L-PS02PO-M00	PS43L-PS02PR-M00	PS43L-PS02RH-M00	PS43L-PS02RT-M00
Slow 1NO+2NC	⊕	PS43L-PT12PO-M00	PS43L-PT12PR-M00	PS43L-PT12RH-M00	PS43L-PT12RT-M00
Slow 2NO+1NC	⊕	PS43L-PT21PO-M00	PS43L-PT21PR-M00	PS43L-PT21RH-M00	PS43L-PT21RT-M00
Slow 3NC	⊕	PS43L-PT03PO-M00	PS43L-PT03PR-M00	PS43L-PT03RH-M00	PS43L-PT03RT-M00
Slow 3NO		PS43L-PT30PO-M00	PS43L-PT30PR-M00	PS43L-PT30RH-M00	PS43L-PT30RT-M00

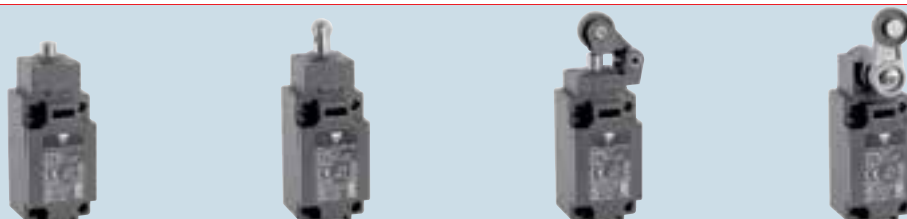

### Family: L

	PS31	PS31	PS31	PS31
	Thermoplastic*	Thermoplastic*	Thermoplastic*	Thermoplastic*
Dimensions HxWxD (mm)	41 x 104 x 40.5	41 x 117 x 40.5	41 x 121 x 40.5	41 x 130 x 59

### References contact block

Snap 1NO+1NC	⊕	PS31L-PS11PO-T00	PS31L-PS11PR-T00	PS31L-PS11RH-T00	PS31L-PS11RT-T00
Slow 1NO+1NC	⊕	PS31L-PT11PO-T00	PS31L-PT11PR-T00	PS31L-PT11RH-T00	PS31L-PT11RT-T00
Slow Ov.**1NO+1NC	⊕	PS31L-PO11PO-T00	PS31L-PO11PR-T00	PS31L-PO11RH-T00	PS31L-PO11RT-T00
Slow 2NO		PS31L-PT20PO-T00	PS31L-PT20PR-T00	PS31L-PT20RH-T00	PS31L-PT20RT-T00
Slow 2NC	⊕	PS31L-PT02PO-T00	PS31L-PT02PR-T00	PS31L-PT02RH-T00	PS31L-PT02RT-T00
Snap 2NC	⊕	PS31L-PS02PO-T00	PS31L-PS02PR-T00	PS31L-PS02RH-T00	PS31L-PS02RT-T00
Slow 1NO+2NC	⊕	PS31L-PT12PO-T00	PS31L-PT12PR-T00	PS31L-PT12RH-T00	PS31L-PT12RT-T00
Slow 2NO+1NC	⊕	PS31L-PT21PO-T00	PS31L-PT21PR-T00	PS31L-PT21RH-T00	PS31L-PT21RT-T00
Slow 3NC	⊕	PS31L-PT03PO-T00	PS31L-PT03PR-T00	PS31L-PT03RH-T00	PS31L-PT03RT-T00
Slow 3NO	⊕	PS31L-PT30PO-T00	PS31L-PT30PR-T00	PS31L-PT30RH-T00	PS31L-PT30RT-T00

\* also available in metal (M type)

\*\* Ov. : overlapping travel paths

# Limit switches - Limit type

## Head types

**W1** Adjustable lever with Ø50 rubber roller

**R1** Adjustable lever with Ø18 nylon roller

**BE** Ø50 nylon roller lever

**LW** Stainless steel spring cat whisker



## Family: L

	PS43 Metal	PS43 Metal	PS43 Metal	PS43 Metal
Dimensions HxWxD (mm)	62 x (147.5-203.5) x 62.5	62 x (133.5-189.5) x 60	62 x 142.5 x 66	62 x 195,5 x 43

## References contact block

Snap 1NO+1NC	PS43L-PS11W1-M00	PS43L-PS11R1-M00	PS43L-PS11W0-M00	PS43L-PS11LW-M00
Slow 1NO+1NC	PS43L-PT11W1-M00	PS43L-PT11R1-M00	PS43L-PT11W0-M00	PS43L-PT11LW-M00
Slow Ov.**1NO+1NC	PS43L-PO11W1-M00	PS43L-PO11R1-M00	PS43L-PO11W0-M00	PS43L-PO11LW-M00
Slow 2NO	PS43L-PT20W1-M00	PS43L-PT20R1-M00	PS43L-PT20W0-M00	PS43L-PT20LW-M00
Slow 2NC	PS43L-PT02W1-M00	PS43L-PT02R1-M00	PS43L-PT02W0-M00	PS43L-PT02LW-M00
Snap 2NC	PS43L-PS02W1-M00	PS43L-PS02R1-M00	PS43L-PS02W0-M00	PS43L-PS02LW-M00
Slow 1NO+2NC	PS43L-PT12W1-M00	PS43L-PT12R1-M00	PS43L-PT12W0-M00	PS43L-PT12LW-M00
Slow 2NO+1NC	PS43L-PT21W1-M00	PS43L-PT21R1-M00	PS43L-PT21W0-M00	PS43L-PT21LW-M00
Slow 3NC	PS43L-PT03W1-M00	PS43L-PT03R1-M00	PS43L-PT03W0-M00	PS43L-PT03LW-M00
Slow 3NO	PS43L-PT30W1-M00	PS43L-PT30R1-M00	PS43L-PT30W0-M00	PS43L-PT30LW-M00



## Family: L

	PS31 Thermoplastic*	PS31 Thermoplastic*	PS31 Thermoplastic*	PS31 Thermoplastic*
Dimensions HxWxD (mm)	50 x (149-205) x 65	41 x (135-191) x 60	50 x 144 x 64.5	41 x 195 x 40.5

## References contact block

Snap 1NO+1NC	PS31L-PS11W1-T00	PS31L-PS11R1-T00	PS31L-PS11W0-T00	PS42L-PS11LW-T00
Slow 1NO+1NC	PS31L-PT11W1-T00	PS31L-PT11R1-T00	PS31L-PT11W0-T00	PS42L-PT11LW-T00
Slow Ov.**1NO+1NC	PS31L-PO11W1-T00	PS31L-PO11R1-T00	PS31L-PO11W0-T00	PS31L-PO11LW-T00
Slow 2NO	PS31L-PT20W1-T00	PS31L-PT20R1-T00	PS31L-PT20W0-T00	PS31L-PT20LW-T00
Slow 2NC	PS31L-PT02W1-T00	PS31L-PT02R1-T00	PS31L-PT02W0-T00	PS31L-PT02LW-T00
Snap 2NC	PS31L-PS02W1-T00	PS31L-PS02R1-T00	PS31L-PS02W0-T00	PS31L-PS02LW-T00
Slow 1NO+2NC	PS31L-PT12W1-T00	PS31L-PT12R1-T00	PS31L-PT12W0-T00	PS31L-PT12LW-T00
Slow 2NO+1NC	PS31L-PT21W1-T00	PS31L-PT21R1-T00	PS31L-PT21W0-T00	PS31L-PT21LW-T00
Slow 3NC	PS31L-PT03W1-T00	PS31L-PT03R1-T00	PS31L-PT03W0-T00	PS31L-PT03LW-T00
Slow 3NO	PS31L-PT30W1-T00	PS31L-PT30R1-T00	PS31L-PT30W0-T00	PS31L-PT30LW-T00

## General specifications (for all types)

Degree of protection	IP 65 (plastic body) IP 66 (metal body)	Rated operational current	
Rated insulation voltage plastic body	(U <sub>i</sub> )	le/AC-15 230 VAC	3.1 A
according to IEC 60947-1 and EN 60947-1	500 V	le/AC-13 24 VDC	2.8 V
according to UL 508, CSA C22-2 n°14	A 600, Q 600	Electrical durability (according to IEC 60947-5-1 annex C)	
Rated insulation voltage metal body	(U <sub>i</sub> )	max. switching frequency Cycles/h	3600
according to IEC 60947-1 and EN 60947-1	400 V (PS21, PS42)	load factor	0.5
	500 V (PS31, PS43)	Air temperature near the device	
according to UL 508, CSA C22-2 n°14	A 300, Q 300 (PS21, PS42)	during operation	-25 to +70°C
	A 600, Q 600 (PS31, PS43)	for storage	-30 to +80°C
Conventional enclosed thermal voltage (U <sub>imp</sub> )	6 kV	Approvals	CE - UL - CSA

\* also available in metal (M type)

\*\* Ov. : overlapping travel paths

# Limit switches - Safety type

**Head types** **Key Actuator 90° adj. head (key must be ordered separately)**

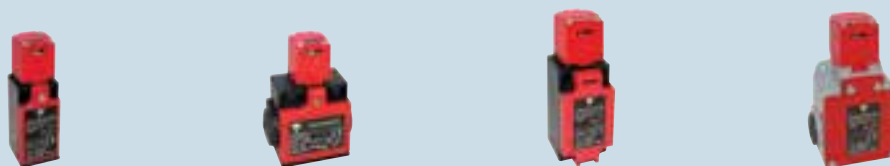

## Family: S

	PS21	PS42	PS31	PS43
	Thermoplastic*	Thermoplastic*	Thermoplastic*	Thermoplastic*
Dimensions HxWxD (mm)	30.3 x 90 x 30	57 x 83 x 33	41.3 x 109.5 x 41	43 x 104.5 x 66

### References contact block

Snap 1NO+1NC	⊕	PS21S-PS1105-T00	PS42S-PS1105-T00	PS31S-PS1105-T00	PS43S-PS1105-Y00
Snap 2NC	⊕	PS21S-PS0205-T00	PS42S-PS0205-T00	PS31S-PS0205-T00	PS43S-PS0205-Y00
Slow 1NO+1NC	⊕	PS21S-PT1105-T00	PS42S-PT1105-T00	PS31S-PT1105-T00	PS43S-PT1105-Y00
Slow Ov.**1NO+1NC	⊕	PS21S-PO1105-T00	PS42S-PO1105-T00	PS31S-PO1105-T00	PS43S-PO1105-Y00
Slow 2NC	⊕	PS21S-PT0205-T00	PS42S-PT0205-T00	PS31S-PT0205-T00	PS43S-PT0205-Y00
Slow 2NO+1NC	⊕			PS31S-PT2105-T00	PS43S-PT2105-Y00
Slow 1NO+2NC	⊕			PS31S-PT1205-T00	PS43S-PT1205-Y00
Slow 3NC	⊕			PS31S-PT0305-T00	PS43S-PT0305-Y00

**Head types** **Key actuator fully turnable head (key must be ordered separately)**

**Hinge Switch  
Operated lever\***

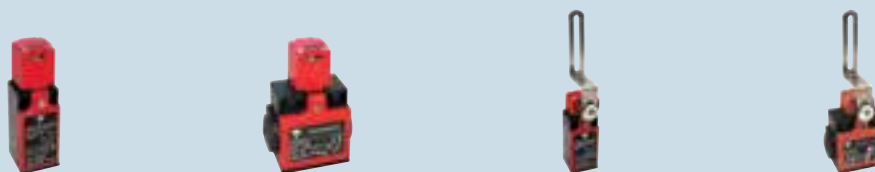

## Family: S / H

	PS21	PS42	PS21	PS42
	Thermoplastic*	Thermoplastic*	Thermoplastic*	Thermoplastic*
Dimensions HxWxD (mm)	30.3 x 98.6 x 30	57 x 91.5 x 33	30.3 x 157 x 42	57 x 150 x 42

### References contact block

Snap 1NO+1NC	⊕	PS21S-PS1109-T00	PS42S-PS1109-T00	PS21H-PS11HC-T00	PS42H-PS11HC-T00
Snap 2NC	⊕	PS21S-PS0209-T00	PS42S-PS0209-T00	PS21H-PS02HC-T00	PS42H-PS02HC-T00
Slow 1NO+1NC	⊕	PS21S-PT1109-T00	PS42S-PT1109-T00	PS21H-PT11HC-T00	PS42H-PT11HC-T00
Slow Ov.**1NO+1NC	⊕	PS21S-PO1109-T00	PS42S-PO1109-T00	PS21H-PO11HC-T00	PS42H-PO11HC-T00
Slow 2NC	⊕	PS21S-PT0209-T00	PS42S-PT0209-T00	PS21H-PT02HC-T00	PS42H-PT02HC-T00

**Head types** **Hinge shaft  
Zinc plated steel**

**Hinge Shaft  
Stainless steel**

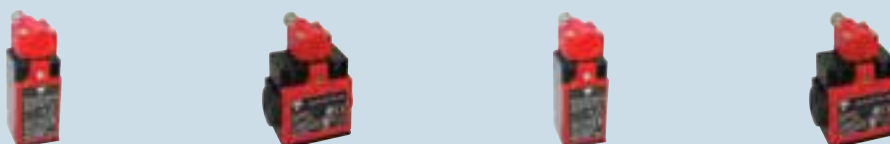

## Family: H

	PS21	PS42	PS21	PS42
	Thermoplastic*	Thermoplastic*	Thermoplastic*	Thermoplastic*
Dimensions HxWxD (mm)	30.3 x 79.5 x 51.2	57 x 72.5 x 52.5	30.3 x 79.5 x 51.2	30.3 x 72.5 x 52.5

### References Contact Block

Snap 1NO+1NC	⊕	PS21H-PS11HZ-T00	PS42H-PS11HZ-T00	PS21H-PS11HS-T00	PS42H-PS11HS-T00
Snap 2NC	⊕	PS21H-PS02HZ-T00	PS42H-PS02HZ-T00	PS21H-PS02HS-T00	PS42H-PS02HS-T00
Slow 1NO+1NC	⊕	PS21H-PT11HZ-T00	PS42H-PT11HZ-T00	PS21H-PT11HS-T00	PS42H-PT11HS-T00
Slow Ov.**1NO+1NC	⊕	PS21H-PO11HZ-T00	PS42H-PO11HZ-T00	PS21H-PO11HS-T00	PS42H-PO11HS-T00
Slow 2NC	⊕	PS21H-PT02HZ-T00	PS42H-PT02HZ-T00	PS21H-PT02HS-T00	PS42H-PT02HS-T00

\* also available in metal (M type)

\*\* Ov. : overlapping travel paths

# Limit switches - Safety type

## Head types

**Pull wire activated head  
16m cable max**



### Family: R

	<b>PS31</b> Metal	<b>PS43</b> Metal
Dimensions HxWxD (mm)	40 x 162.75 x 43	63 x 158.25 x 43.3
<b>References contact block</b>		
Snap 1NO+1NC	PS31R-PS11N7-Y00	PS43R-PS11N7-Y00
Snap 2NC	PS31R-PS02N7-Y00	PS43R-PS02N7-Y00
Slow 1NO+1NC	PS31R-PT11N7-Y00	PS43R-PT11N7-Y00
Slow Ov.**1NO+1NC	PS31R-PO11N7-Y00	PS43R-PO11N7-Y00
Slow 2NC	PS31R-PT02N7-Y00	PS43R-PT02N7-Y00
Slow 2NO+1NC	PS31R-PT21N7-Y00	PS43R-PT21N7-Y00
Slow 1NO+2NC	PS31R-PT12N7-Y00	PS43R-PT12N7-Y00
Slow 3NC	PS31R-PT03N7-Y00	PS43R-PT03N7-Y00

## Head types

**Pull wire activated head  
with pull button reset - 16m cable max**



### Family: H

	<b>PS31</b> Metal	<b>PS43</b> Metal
Dimensions HxWxD (mm)	40 x 162.75 x 43	63 x 158.25 x 44
<b>References contact block</b>		
Snap 1NO+1NC	PS31R-PS11N7-YK0	PS43R-PS11N7-YK0
Snap 2NC	PS31R-PS02N7-YK0	PS43R-PS02N7-YK0
Slow 1NO+1NC	PS31R-PT11N7-YK0	PS43R-PT11N7-YK0
Slow Ov.**1NO+1NC	PS31R-PO11N7-YK0	PS43R-PO11N7-YK0
Slow 2NC	PS31R-PT02N7-YK0	PS43R-PT02N7-YK0
Slow 2NO+1NC	PS31R-PT21N7-YK0	PS43R-PT21N7-YK0
Slow 1NO+2NC	PS31R-PT12N7-YK0	PS43R-PT12N7-YK0
Slow 3NC	PS31R-PT03N7-YK0	PS43R-PT03N7-YK0

## General specifications (for all types)

Degree of protection	IP 65 (plastic body) IP 66 (metal body)	Rated operational current
Rated insulation voltage plastic body	(U <sub>i</sub> ) 500 V according to IEC 60947-1 and EN 60947-1	le/AC-15 230 VAC 3.1 A le/AC-13 24 VDC 2.8 V
Rated insulation voltage metal body	(U <sub>i</sub> ) 400 V (PS21, PS42) 500 V (PS31, PS43) according to IEC 60947-1 and EN 60947-1	Electrical durability (according to IEC 60947-5-1 annex C) max. switching frequency Cycles/h 3600 load factor 0.5
Conventional enclosed thermal voltage (U <sub>imp</sub> )	6 kV	Air temperature near the device during operation -25 to +70°C for storage -30 to +80°C
		Approvals CE - UL - CSA

\* also available in metal (Y type) \*\* Ov. : overlapping travel paths

# Limit switches - Safety type with pull button reset

Head Types	PO Steel plunger	PR Steel plunger with nylon roller	R3 Plastic roller lever on metal plunger	RT Lever with nylon roller
				



<b>Family: K</b>				
	PS21	PS21	PS21	PS21
	Thermoplastic*	Thermoplastic*	Thermoplastic*	Thermoplastic*
Dimensions HxWxD (mm)	30.3 x 88 x 36.5	30.3 x 99 x 36.5	30.3 x 107 x 36.5	39 x 106 x 45

<b>References contact block</b>					
Snap 1NO+1NC	⊕	PS21K-PS11PO-T00	PS21K-PS11PR-T00	PS21K-PS11R3-T00	PS43S-PS1105-Y00
Snap 2NC	⊕	PS21K-PS02PO-T00	PS21K-PS02PR-T00	PS21K-PS02R3-T00	PS43S-PS0205-Y00
Slow 1NO+1NC	⊕	PS21K-PT11PO-T00	PS21K-PT11PR-T00	PS21K-PT11R3-T00	PS43S-PT1105-Y00
Slow 2NC	⊕	PS21K-PT02PO-T00	PS21K-PT02PR-T00	PS21K-PT02R3-T00	PS21K-PT02RT-T00

				
--	---	---	---	---

<b>Family: K</b>				
	PS42	PS42	PS42	PS42
	Thermoplastic*	Thermoplastic*	Thermoplastic*	Thermoplastic*
Dimensions HxWxD (mm)	57 x 81 x 36.5	57 x 92 x 36.5	57 x 100 x 36.5	57 x 99 x 45

<b>References contact block</b>					
Snap 1NO+1NC	⊕	PS42K-PS11PO-T00	PS42K-PS11PR-T00	PS42K-PS11R3-T00	PS42K-PS11RT-T00
Snap 2NC	⊕	PS42K-PS02PO-T00	PS42K-PS02PR-T00	PS42K-PS02R3-T00	PS42K-PS02RT-T00
Slow 1NO+1NC	⊕	PS42K-PT11PO-T00	PS42K-PT11PR-T00	PS42K-PT11R3-T00	PS42K-PT11RT-T00
Slow 2NC	⊕	PS42K-PT02PO-T00	PS42K-PT02PR-T00	PS42K-PT02R3-T00	PS42K-PT02RT-T00

Head Types	R4 Roller Lever, external side actuation	LR Roller Lever Ø22, side actuation
		

<b>Family: K</b>		
	PS21	PS42
	Thermoplastic*	Thermoplastic*
Dimensions HxWxD (mm)	44 x 107 x 36.5	57 x 112 x 36.5

<b>References contact block</b>			
Snap 1NO+1NC	⊕	PS21K-PS11R4-T00	PS42K-PS11LR-T00
Snap 2NC	⊕	PS21K-PS02R4-T00	PS42K-PS02LR-T00
Slow 1NO+1NC	⊕	PS21K-PT11R4-T00	PS42K-PT11LR-T00
Slow 2NC	⊕	PS21K-PT02R4-T00	PS42K-PT02LR-T00

<b>General specifications (for all types)</b>			
Degree of protection	IP 65	Rated operational current	
Rated insulation voltage plastic body	(U <sub>i</sub> )	le/AC-15 230 VAC	3.1 A
according to IEC 60947-1 and EN 60947-1	500 V	le/AC-13 24 VDC	2.8 V
according to UL 508, CSA C22-2 n°14	A 600, Q 600	Electrical durability (according to IEC 60947-5-1 annex C)	
Rated insulation voltage metal body	(U <sub>i</sub> )	max. switching frequency Cycles/h	3600
according to IEC 60947-1 and EN 60947-1	400 V	load factor	0.5
	500 V	Air temperature near the device	
according to UL 508, CSA C22-2 n°14	A 300, Q 300 (PS21, PS42)	during operation	-25 to +70°C
	A 600, Q 600 (PS31, PS43)	for storage	-30 to +80°C
Conventional enclosed thermal voltage (U <sub>imp</sub> )	6 kV	Approvals	CE - UL - CSA

\* Also available in metal (Y type) other types available

# Industrial and Midi industrial relays

	Industrial relays		Midi industrial relays	
Types	RCP 8 (2 Poles)	RCP 11 (3 Poles)	RMI 2-10 (2 Poles)	RMI 4-5 (4 Poles)
				

Dimensions HxWxD (mm)	56 x 35.5 x 35.5	56 x 35.5 x 35.5	36 x 21.5 x 28	36 x 21.5 x 28
No. of Contacts	2 Change-over (octal)	3 change-over (undecal)	2 Change-over	4 Change-over
Contact rating	10 A	10 A	10 A	5 A
Features standard with	Test button / Flag / LED	Test button / Flag / LED	Test button / Flag / LED	Test button / Flag / LED

## Output specifications

Max. load AC1	12 A / 250 VAC	12 A / 250 VAC	12 A / 250 VAC	6 A / 250 VAC
Min. load	100 mA / 12 VDC	100 mA / 125 VDC	100 mA / 5 VDC	100 mA / 5 VDC
Electrical life	> 100.000 cycles	> 100.000 cycles	> 100.000 cycles	> 100.000 cycles
Switching power	2500 VA (resistive)	2500 VA (resistive)	2500 VA (resistive)	1250 VA (resistive)

## General specifications

Voltage ranges VDC	6 - 12 - 24 - 48 - 60 - 100 - 110	6 - 12 - 24 - 48 - 60 - 100 - 110	5 - 6 - 9 - 12 - 24 - 36 - 48 - 60 - 100 - 110 - 220 - 240	5 - 6 - 9 - 12 - 24 - 36 - 48 - 60 - 100 - 110 - 220 - 240
Voltage ranges VAC	6 - 12 - 24 - 48 - 115/120 - 230	6 - 12 - 24 - 48 - 115/120 - 230	6 - 12 - 24 - 36 - 48 - 115/120 - 220 - 240 - 380	6 - 12 - 24 - 36 - 48 - 115/120 - 220 - 240 - 380
Insulation according to	EN 61810-5	EN 61810-5	EN 61810-5	EN 61810-5
Consumption	1.5 W DC-2.5 VA AC	1.5 W DC-2.5 VA AC	1 W DC-1.5 VA AC	1 W DC-1.5 VA AC
Approvals / Conformity	UL - CSA - TÜV - IMQ	UL - CSA - TÜV - IMQ	UL - CSA - TÜV - IMQ	UL - CSA - TÜV - IMQ

## References

5 VDC			RMIA/B2-105 DC	RMIA/B4-55 DC
6 VAC	RCP80026 VDC	RCP110036 VDC	RMIA/B2-106 AC	RMIA/B4-56 AC
6 VDC	RCP80026 VAC	RCP110036 VAC	RMIA/B2-106 DC	RMIA/B4-56 DC
12 VAC	RCP800212 VAC	RCP1100312 VAC	RMIA/B2-1012 AC	RMIA/B4-512 AC
12 VDC	RCP800212 VDC	RCP1100312 VDC	RMIA/B2-1012 DC	RMIA/B4-512 DC
24 VAC	RCP800224 VAC	RCP1100324 VAC	RMIA/B2-1024 AC	RMIA/B4-524 AC
24 VDC	RCP800224 VDC	RCP1100324 VDC	RMIA/B2-1024 DC	RMIA/B4-524 DC
48 VAC	RCP800248 VAC	RCP1100348 VAC	RMIA/B2-1048 AC	RMIA/B4-548 AC
48 VDC	RCP800248 VDC	RCP1100348 VDC	RMIA/B2-1048 DC	RMIA/B4-548 DC
60 VDC	RCP800260 VDC	RCP1100360 VDC	RMIA/B2-1060 DC	RMIA/B4-560 DC
100 VDC	RCP8002100 VDC	RCP11003100 VDC	RMIA/B2-10100 DC	RMIA/B4-5100 DC
110 VDC	RCP8002110 VDC	RCP11003110 VDC	RMIA/B2-10110 DC	RMIA/B4-5110 DC
115/120 VAC	RCP8002115/120 VAC	RCP11003115/120 VAC	RMIA/B2-10115 AC	RMIA/B4-5115 AC
230 VAC	RCP8002230 VDC	RCP11003230 VDC	RMIA/B2-10230 AC	RMIA/B4-5230 AC

	Industrial relays sockets		Midi industrial relays sockets	
Types	ZPD 8XA ZPD 11XA	ZPD 8A ZPD 11A	ZMI 2NA ZMI 4NA	ZMI 2 / 3 / 4SA
				

## General specifications





Dimensions HxWxD (mm)	65 X 27 X 38	65 X 27 X 38	42.5 x 75 x 27	42.5 x 75 x 27
Rated volt. / Rated curr.	10 A @ 400 VAC	10 A @ 400 VAC	10 A @ 300 VAC	10/12 A @ 300 VAC
Insulation voltage	> 3 kV	> 3 kV	> 4 kV	> 4 kV
Socket material	Self-ext. PA6 + GF (V1)	Self-ext. PA6 + GF (V1)	Self-ext. PA6 + GF (V2)	Self-ext. PA6 + GF (V2)
Mounting	DIN-rail	DIN-rail	DIN-rail	DIN-rail
Degree of protection	IP 20	IP 20	IP 20	IP 20
Approvals	CE - UL - CSA (10 A 300 VCA)	CE - UL	CE - UL - IMQ - RINA	CE - UL - CSA

## References



For RCP 8 / RCP 11	ZPD 8XA / ZPD 11XA	ZPD 8A / ZPD 11A		
For RMI2-10 / RMI4-5			ZPD 8A / ZPD 11A	ZMI 2 / 3 / 4SA

# Midi industrial relays

## Midi industrial relays





Types	RPY 1	RPY 2	RPY 3	RPY 4
				
Dimensions HxWxD (mm)	36 x 21.5 x 28	36 x 21.5 x 28	36 x 31.5 x 28	36 x 41.5 x 28
No. of Contacts	Faston or PCB	Faston or PCB	Faston or PCB	Faston or PCB
Contact rating	1 Change-over	2 Change-over	3 Change-over	4 Change-over
Terminal types	16 A	10 A	10 A	10 A
<b>Output specifications</b>				
Max. load AC1	16 A	10 A	10 A	10 A
Electrical life	1 x 10 <sup>5</sup>	1 x 10 <sup>5</sup>	1 x 10 <sup>5</sup>	1 x 10 <sup>5</sup>
Switching power	1 HP at 240 VAC 1/2 HP at 120 VAC	3/4 HP at 240 VAC 1/3 HP at 120 VAC	3/4 HP at 240 VAC 1/3 HP at 120 VAC	3/4 HP at 240 VAC 1/3 HP at 120 VAC
<b>General specifications</b>				
Voltage ranges VDC	6 - 9 - 12 - 24 - 36 - 48 100 - 110 - 220 - 240	6 - 9 - 12 - 24 - 36 - 48 100 - 110 - 220 - 240	6 - 9 - 12 - 24 - 36 - 48 100 - 110 - 220	6 - 9 - 12 - 24 - 36 - 48 100 - 110 - 220
Voltage ranges VAC	6 - 12 - 24 - 36 - 48 - 110 120 - 120 - 220 - 240 - 380	6 - 12 - 24 - 36 - 48 - 110 120 - 120 - 220 - 240 - 380	6 - 12 - 24 - 36 - 48 - 110 120 - 120 - 220 - 240 - 380	6 - 12 - 24 - 36 - 48 - 110 120 - 120 - 220 - 240 - 380
Insulation Coil / Contact	2000/1200 VAC	2000/1200 VAC	2000/1200 VAC	2000/1200 VAC
Consumption	DC=0.9 W - AC=1.2 VA	DC=0.9 W - AC=1.2 VA	DC=1.4 W - AC=2 VA	DC=1.5 W - AC=2.5 VA
Approvals / Conformity	UL - CSA - TÜV	UL - CSA - TÜV	UL - CSA - TÜV	UL - CSA - TÜV
<b>References</b>				
Consult your Carlo Gavazzi Partner or Distributor	Several options available: Led, diode, etc...	Several options available: Led, diode, etc...	Several options available: Led, diode, etc...	Several options available: Led, diode, etc...



## Midi industrial relays sockets

Types	ZPY08A	ZPY11A	ZPY14A
			
<b>General specifications</b>			
Dimensions HxWxD (mm)	27.8 x 30 x 69.8	27.8 x 40 x 69.8	27.8 x 50.5 x 69.8
Rated volt. / Rated curr.	10 A @ 300 VAC	10 A @ 300 VAC	10 A @ 300 VAC
Insulation voltage	> 4 kW	> 4 kW	> 4 kW
Socket material	PA6 - V2	PA6 - V2	PA6 - V2
Mounting	DIN Rail	DIN Rail	DIN Rail
Degree of protection	IP 00	IP 00	IP 00
Approvals	UL - cUL - CSA	UL - cUL - CSA	UL - cUL - CSA
<b>References</b>			
Consult your Carlo Gavazzi Partner or Distributor	For Relays: RPYA 001 and RPYA 002	For Relays: RPYA 003	For Relays: RPYA 004

## Power relays

### Power relays

Types	NA (1/2 Poles)	NB (1/2 Poles)	NF (1/2 Poles)	NP (1/2 Poles)
				
Dimensions HxWxD (mm)	36 x 50.5 x 33.5	55 x 50.5 x 54.5	36 x 50.5 x 54.5	36 x 50.5 x 33.5
No. of Contacts	1 Normally open 2 Normally open	1 Normally open 2 Normally open	1 Normally open 2 Normally open	1 Normally open 2 Normally open
Contact rating	30 A	30 A	30 A	30 A
Terminal types	Faston	Bolt	Faston	PCB
<b>Output specifications</b>				
Max. load AC1	30 A (1NO) - 25 A (2NO)	30 A (1NO) - 25 A (2NO)	30 A (1NO) - 25 A (2NO)	30 A (1NO) - 25 A (2NO)
Electrical life	1 x 10 <sup>5</sup>	1 x 10 <sup>5</sup>	1 x 10 <sup>5</sup>	1 x 10 <sup>5</sup>
Switching power	7500 VA / 840 W	7500 VA / 840 W	7500 VA / 840 W	7500 VA / 840 W
<b>General specifications</b>				
Voltage ranges VDC	3 - 6 - 12 - 24 - 48 100 - 110 - 200	3 - 6 - 12 - 24 - 48 100 - 110 - 200	3 - 6 - 12 - 24 - 48 100 - 110 - 200	3 - 6 - 12 - 24 - 48 100 - 110 - 200
Voltage ranges VAC	6 - 12 - 24 - 48 - 120 - 220	6 - 12 - 24 - 48 - 120 - 220	6 - 12 - 24 - 48 - 120 - 220	6 - 12 - 24 - 48 - 120 - 220
Insulation according to	4000 VAC	4000 VAC	4000 VAC	4000 VAC
Consumption	DC=1.9 W - AC=2.7 VA	DC=1.9 W - AC=2.7 VA	DC=1.9 W - AC=2.7 VA	DC=1.9 W - AC=2.7 VA
Approvals / Conformity	UL - cUL	UL - cUL	UL - cUL	UL - cUL

Types	CF (2 Poles)	CS (2 Poles)
		
Dimensions (mm) WxHxD	26.42 x 68.58 x 34.54	26.42 x 52.32 x 34.54
No. of Contacts	2 Normally open 2 Change-over	2 Normally open 2 Change-over
Contact rating	30 A	30 A
Terminal types	Faston	PCB
<b>Output specifications</b>		
Max. load AC1	30 A (2NO) - 20 A (2CO)	30 A (2NO) - 20 A (2CO)
Electrical life	1 x 10 <sup>5</sup>	1 x 10 <sup>5</sup>
Switching power	8310 VA / 840 W	8310 VA / 840 W
<b>General specifications</b>		
Voltage ranges VDC	6 - 12 - 24 - 48	6 - 12 - 24 - 48
Voltage ranges VAC	24 - 120 - 208 - 240 - 277	24 - 120 - 208 - 240 - 277
Insulation according to	4000 VAC	4000 VAC
Consumption	DC=1.7 W - AC=4 VA	DC=1.7 W - AC=4 VA
Approvals / Conformity	UL - cUL	UL - cUL



# Sockets for electromechanical relays

Types	ZD 35/2A	ZD 50/2A	ZD 35/3A	ZD 50/3A
-------	----------	----------	----------	----------



## General specifications

Rated volt. / Rated curr.	12 A @ 300 VAC	12 A @ 300 VAC	12 A @ 300 VAC	12 A @ 300 VAC
Insulation voltage	> 5 kV	> 5 kV	> 5 kV	> 5 kV
Socket material	Self-ext. PA 6 + GF (V1)	Self-ext. PA 6 + GF (V1)	Self-ext. PA 6 + GF (V1)	Self-ext. PA 6 + GF (V1)
Mounting	DIN-rail	DIN-rail	DIN-rail	DIN-rail
Degree of protection	IP 20	IP 20	IP 20	IP 20
Approvals	UL - CSA (12 A, 300 VCA)	UL - CSA (12 A, 300 VCA)	UL - CSA (12 A, 300 VCA)	UL - CSA (12 A, 300 VCA)

## References

For relay:	MZ 1P 5/10 A	MZ B 1P 5/10 A	MZ 1P 5/10 A	MZ B 1P 5/10 A
	M15 M 8A	MZ 2P 5/10 A	M15 M 8 A	MZ 2P 5/10 A
	M25 1P 12 A	MZ 1P 16 A	M25 1P 12 A	MZ 1P 16 A
	LC 10 A	M15 M 8 A	LC 10 A	M15 M 8 A
		M25 1P 16 A		M25 1P 16 A
		M25 2P 8 A		M25 2P 8 A
	LC 5/16 A		LC 5/16 A	

For detailed informations consult your Carlo Gavazzi Partner or Distributor

Hold down spring to be ordered separately:  
 • SZD15 for M15/M25 relays  
 • SZD20 for LC relays  
 • SZD25 for MZ relays

Hold down spring to be ordered separately:  
 • SZD15 for M15/M25 relays  
 • SZD20 for LC relays  
 • SZD25 for MZ relays

Hold down spring to be ordered separately:  
 • SZD15 for M15/M25 relays  
 • SZD20 for LC relays  
 • SZD25 for MZ relays

Hold down spring to be ordered separately:  
 • SZD15 for M15/M25 relays  
 • SZD20 for LC relays  
 • SZD25 for MZ relays

## Types

## Additional modules for ZMI and ZD sockets

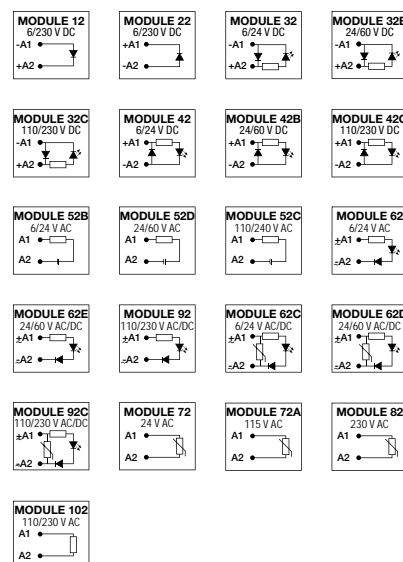
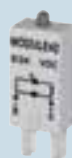

## General specifications

Dimensions (mm) WxHxD	23 x 12.5 x 8.5
Terminal material	CuSn
Degree of protection	IP 40
Operating temperature	-40°C to +70°C
Ambient humidity	85RH non condensing
Approvals / Conformity	No approvals

## References

Consult your Carlo Gavazzi Partner or Distributor





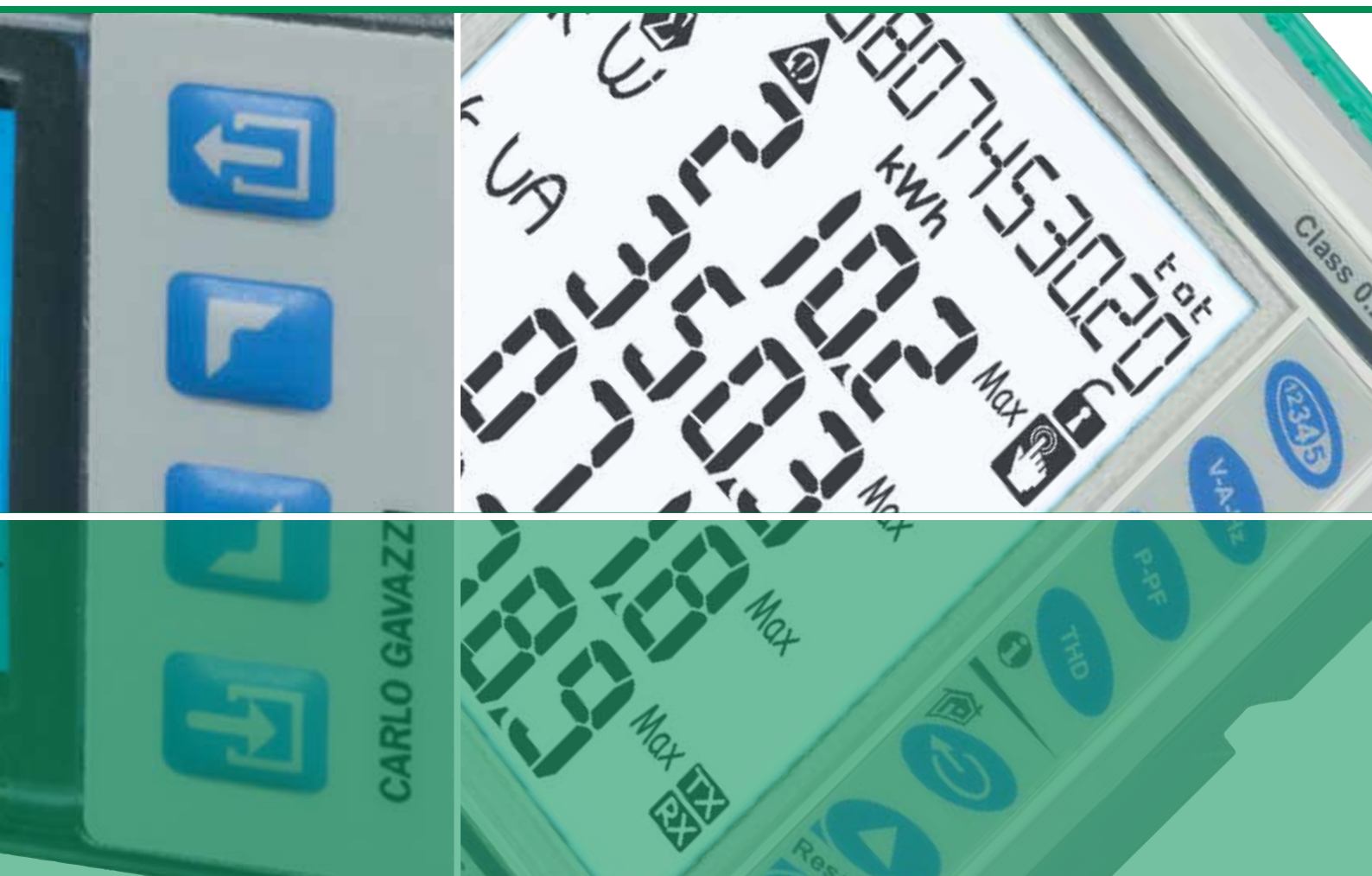

# Controls



Energy management	164
Current transformers	176
Energy monitoring solution	184
PV monitoring solution	187
Monitoring relays	192
Timers	204
Counters	209
Surge arresters	212
Digital panel meters	214
Converters and Gateway	218
Safety modules	219
Configurable safety modules	223
Switching power supplies	225

## Energy management

	Energy meter	Energy analyzer	Energy meters	
Types	EM10 DIN	EM11 DIN	EM21 72D/72V	EM21 72R
				
Dimensions HxWxD (mm)	90 x 18 x 67	90 x 18 x 67	72 x 72 x 65	72 x 72 x 65
Description	1-phase energy meter 1-DIN module	1-phase energy analyzer 1-DIN module	3-phase energy meter 4-DIN modules and 72 x 72 panel mounting	3-phase energy meter 4-DIN modules and 72 x 72 panel mounting
Function	kWh	V, A, Hz, W, Wdmd, var, PF, kWh, kvarh TRMS method	System: kWh, kvarh, W, var, PF, Hz, Phase sequence Single-phase: V <sub>LN</sub> , V <sub>LL</sub> , A, PF TRMS method	System: kWh, kvarh, W, var, PF, Hz, Phase sequence Single-phase: V <sub>LN</sub> , V <sub>LL</sub> , A, PF TRMS method

### Input specifications

Range code	120 VAC [AV7] 230 VAC [AV8] Ib: 5 A, I <sub>max</sub> : 32 AAC	120 VAC [AV7] 230 VAC [AV8] Ib: 5 A, I <sub>max</sub> : 32 AAC	120 / 230 VAC, 400 VAC In: 5 A; I <sub>max</sub> : 6 A (72 D) 3-phase by CTV current sensor (72V)	120 / 230 VAC, 400 VAC In: 5 A; I <sub>max</sub> : 6 A 3-phase by included current sensor
Accuracy		±0.5% RDG (V, A)	±0.5% RDG (V, A)	±0.5% RDG (V) ±1% RDG (A)
Active energy	Class 1 (EN62053-21) Class B (EN50470-3)	Class 1 (EN62053-21) Class B (EN50470-3)	Class 1 (EN62053-21) Class B (EN50470-3)	Class 2 (EN62053-21) Class A (EN50470-3)
Reactive energy		Class 2 (EN62053-23)	Class 2 (EN62053-23)	
Display	LCD 5+1 DGT (energies)	LCD 4 DGT (inst. variables) 5+1 DGT (energies)	LCD 3 DGT (inst. variables) 6+1 DGT (energies)	LCD 3 DGT (inst. variables) 6+1 DGT (energies), LCD

### Output specifications

Pulse output	1-open collector	1-open collector	1 static opto-mosfet	1 static opto-mosfet
Alarm output		1-relay		
Communication			RS485 (2-wire, Modbus) M-BUS by means of VMU-B	RS485 (2-wire, Modbus) M-BUS by means of VMU-B



### General specifications

Power supply	Self power supply [X]	Self power supply [X]	Self power supply	Self power supply
Approvals / Marks	CE - cULus MID certification (AV8)	CE - cULus MID certification (AV8)	CE - cULus MID certification (72D)	CE - cULus

### References

For ordering key details, please refer to [www.productselection.net](http://www.productselection.net)

# Energy management

	Energy meter Energy analyzer EM210	Quick-fit dual energy meter EM270	3-phase current transformer TCD
<b>Types</b>	<b>EM210</b>	<b>EM270</b>	<b>TCD</b>
			
<b>Dimensions HxWxD (mm)</b>	72 x 72 x 65	72 x 72 x 65	TCD1: 72 x 75 x 66.8 TCD2: 72 x 105 x 50 TCD3: 78 x 135 x 50
<b>Description</b>	3-phase energy analyzer 4-DIN modules and 72 x 72 panel mounting	3-phase energy analyzer 4-DIN modules and 72 x 72 panel mounting	3-phase current transformers for EM270 quick fit meter. Connection to the meter by means of RJ11 connector (included).
<b>Function</b>	System: $\pm$ kWh, kvarh, W, var, PF, Phase- sequence Single-phase: $V_{LL}$ , $V_{LN}$ , A, PF TRMS method	System: kWh, kvarh, kW, kvar Single-phase: kWh, W, $W_{dmd}$ , $W_{dmd\ max}$ , A, $V_{LL}$ , $V_{LN}$ Virtual sum of the two 3-phase or six 1-phase loads TRMS method	Suitable to be installed downstream the circuit breakers (same width). Automatic setting of the CT ratio in the meter
<b>Input specifications</b>			
<b>Range</b>	120 / 230 VAC, 400 VAC In: 5 A; I <sub>max</sub> : 6 A	120 / 230 VAC, 400 VAC In: from 160 to 630 A by TCD	TCD1: 160 A TCD2: 250 A TCD3: 630 A
<b>Accuracy</b>	$\pm$ 0.5% RDG (V, A)	$\pm$ 0.5% RDG (V, A)	Equivalent to class 0.5 (EN60044-1)
<b>Active energy</b>	Class 1 (EN62053-21) Class B (EN50470-3)	Equivalent to Class 1 (EN62053-21)	
<b>Reactive energy</b>	Class 2 (EN62053-23)	Equivalent to Class 2 (EN62053-23)	
<b>Display</b>	LCD 3 DGT (inst. variables) 6+1 DGT (energies)	LCD 3 DGT (inst. variables) 6+1 DGT (energies)	
<b>Output specifications</b>			
<b>Pulse output</b>	1 static opto-mosfet	2 static opto-mosfet	
<b>Communication</b>	RS485 (2-wire, Modbus) M-BUS by means of VMU-B	RS485 (2-wire, Modbus)	
<b>General specifications</b>			
<b>Power supply</b>	Self power supply	Self power supply	n.a.
<b>Approvals / Marks</b>	CE, cULus	CE	CE
<b>References</b>			
For ordering key details, please refer to <a href="http://www.productselection.net">www.productselection.net</a>			

# Energy management

## Quick fit dual energy meter EM271

## 3-phase current transformer TCD\_M

### Types



Dimensions HxWxD (mm)

72 x 72 x 65

TCD0X: 3 by 26 x 40 x 26, hole 9.6  
TCD1X: 3 by 31 x 46 x 31, hole 15.5  
TCD2X: 3 by 41 x 66 x 38, hole 15.5  
TCD3X: 3 by 50 x 78 x 39, hole 20.5

Description

Quick fit energy analyzer with daisy chaining of voltage and serial connections and fast RJ connection of TCD\_M 3-phase split-core current sensors, for retrofit applications.  
Managing of two 3-phase or six 1-phase loads  
4-DIN modules and 72 x 72 panel mounting

3-phase split core current sensors for EM271 quick fit meter.  
Connection to the meter by means of RJ11 connector (included)

Function

System: kWh, kvarh, kW, kvar  
Single-phase: kWh, W, W<sub>dmd</sub>, W<sub>dmd max</sub>, A, V<sub>LL</sub>, V<sub>LN</sub>  
Virtual sum of the two 3-phase or six 1-phase loads  
TRMS method

Suitable to be installed in any existing installation.  
Automatic setting of the CT ratio in the meter

### Input specifications

Range

120 / 230 VAC, 400 VAC  
In: from 60 to 400 A by TCD\_M

TCD0X: 60 A  
TCD1X: 100 A  
TCD2X: 200 A  
TCD3X: 400 A

Accuracy

±0.5% RDG (V, A)

Equivalent to class 1 (EN60044-1)

Active energy

Equivalent to Class 1 (EN62053-21)

Reactive energy

Equivalent to Class 2 (EN62053-23)

Display

LCD  
3 DGT (inst. variables)  
6+1 DGT (energies), LCD

### Output specifications

Pulse output

2 static opto-mosfet

Communication

RS485 (2-wire, Modbus)

### General specifications

Power supply

Self power supply

Approvals / Marks



CE

CE

### References

For ordering key details, please refer to [www.productselection.net](http://www.productselection.net)

# Energy management

	Multifunction meter	Energy meter	Energy analyzer
Types	WM10 DIN	EM23 DIN	EM24 DIN
			
Dimensions HxWxD (mm)	90 x 72 x 67	90 x 72 x 67	90 x 72 x 67
Description	3-phase multifunction meter 4 DIN modules	3-phase energy meter 4 DIN modules	3-phase energy analyzer 4 DIN modules
Function	System: $V_{LN}$ , $V_{LL}$ , W, var, PF, Hz, phase sequence Single-phase: $V_{LN}$ , $V_{LL}$ , A, W, var TRMS method	System: kWh, kvarh, W, var, phase sequence Single-phase: A TRMS method	System: $\pm$ kWh, $\pm$ kvarh, $V_{LL}$ , $V_{LN}$ , var, VA, $W_{dmd}$ , W, $VA_{dmd}$ , Hz, hour counter, gas and water Max: $A_{dmd}$ , $W_{dmd}$ , $VA_{dmd}$ Single-phase: $V_{LL}$ , $V_{LN}$ , A, W, var, VA, PF, kWh, kvarh TRMS method
<b>Input specifications</b>			
Range code	400 $V_{LLAC}$ Ib: 10 A; I <sub>max</sub> 65 A 3-phase	208 / 400 $V_{LL}$ [AV2]; 400 $V_{LL}$ [AV9] Ib: 10 A; I <sub>max</sub> 65 A	120 / 208 $V_{LL}$ [AV6]; 400 $V_{LL}$ [AV5] In: 1 / 5 A, I <sub>max</sub> : 10 AAC; 208/400 $V_{LL}$ [AV2] 400 $V_{LL}$ [AV9] Ib: 10 A, I <sub>max</sub> : 65 AAC
Accuracy	$\pm$ 0.5% RDG (V, A)	$\pm$ 0.5% RDG (V, A)	$\pm$ 0.5% RDG (V, A)
Active energy		Class 1 (EN62053-21) Class B (EN50470-3)	Class 1 (EN62053-21) Class B (EN50470-3)
Reactive energy		Class 2 (EN62053-23)	Class 2 (EN62053-23)
Display	LCD 3 x 3 DGT (inst. variables)	LCD 3 x 3 DGT (inst. variables) 6 +1 DGT (energies)	LCD 3x4 DGT (inst. variables) 8 DGT (energies)
<b>Output specifications</b>			
Pulse output		1-open collector	2-open collector / relay
Alarm output			2-relay / open collector
Communication		Modbus RTU (S1)	Modbus RTU (S1) / M-BUS (Mx) / Dupline (DP)
Inputs			3 digital input
<b>General specifications</b>			
Power supply	Self power supply	Self power supply	Self power supply [X]. Auxiliary power supply: 18 to 60 VAC / DC [L], 115 / 230 VAC [D], according to the model
Approvals / Marks	CE	CE - MID certification	CE - cULus (AV5 and AV6) MID certification
<b>References</b>			
For ordering key details, please refer to <a href="http://www.productselection.net">www.productselection.net</a>			

# Energy management

## Energy meter

### Types

**EM110**



Dimensions HxWxD (mm)

90 x 18 x 63

Description

1-phase energy meter kWh  
1-DIN module

Function

kWh

### Input specifications

Range code

120 VAC [AV7]  
230 VAC [AV8]  
Ib: 5 A, I<sub>max</sub>: 45 AAC;  
1-phase

Accuracy

n.a.

Active energy

Class 1 (EN62053-21)  
Class B (EN50470-3)

Reactive energy

n.a.

Display

Electromechanical  
6+1 DGT (energy)

### Output specifications

Pulse output

1-open collector (O1)

Communication

Inputs

### General specifications

Power supply

Self power supply [X]

Approvals / Marks

CE



### References

For ordering key details, please refer to [www.productselection.net](http://www.productselection.net)



# Energy management

## Energy analyzer

Types	EM111	EM112
		
Dimensions HxWxD (mm)	90 x 18 x 63	90 x 36 x 63
Description	1-phase energy analyser with Touch Tech technology 1-DIN module	1-phase energy analyser with Touch Tech technology 2-DIN modules
Function	$V_{LN}$ , A, Hz, $\pm W$ , $W_{dmd}$ , $W_{dmd\ max}$ , $\pm var$ , PF, $\pm kWh$ , $\pm kvarh$ , kWh+ by tariff (2) TRMS method	$V_{LN}$ , A, Hz, $\pm W$ , $W_{dmd}$ , $W_{dmd\ max}$ , $\pm var$ , PF, $\pm kWh$ , $\pm kvarh$ , kWh+ by tariff (2) TRMS method

### Input specifications

Range code	120 VAC [AV7] 230 VAC [AV8] Ib: 5 A, I <sub>max</sub> : 45 AAC; 1-phase	120 VAC [AV1] 230 VAC [AV0] Ib: 5 A, I <sub>max</sub> : 100 AAC; 1-phase
Accuracy	$\pm 0.5\%$ RDG (V, A)	$\pm 0.5\%$ RDG (V, A)
Active energy	Class 1 (EN62053-21) Class B (EN50470-3)	Class 1 (EN62053-21) Class B (EN50470-3)
Reactive energy	Class 2 (EN62053-23)	Class 2 (EN62053-23)
Display	Backlit LCD with touch keypad 4 DGT (inst. Variables) 7 DGT (energies)	backlit LCD with touch keypad and supercapacitor backup (up to 48h) up to 2 x 4 DGT (inst. variables) 8 DGT (energies)

### Output specifications

Pulse output	1-open collector (O1)	1-open collector (O1)
Communication	Modbus RTU (S1) M-bus (M1)	Modbus RTU (S1) M-bus (M1)
Inputs	1 (dual tariff management)	1 (dual tariff management)



### General specifications

Power supply	Self power supply [X]	Self power supply [X]
Approvals / Marks	CE	CE

### References

For ordering key details, please refer to [www.productselection.net](http://www.productselection.net)

# Energy management

	Multifunction indicator	Power analyzers	
Types	WM12-DIN	WM14 DIN	WM14 Advanced
			
Dimensions HxWxD (mm)	90 x 108 x 64.5	90 x 108 x 64.5	90 x 108 x 64.5
Description	3-phase multifunction power indicator. 6-DIN modules	3-phase power analyzer. 6-DIN modules	3-phase power analyzer. 6-DIN modules
Function	System: $V_{LL}$ , $V_{LN}$ , An, VA, $V_{Admd}$ , $W_{dmd}$ , W, var, PF, Hz Max: A, $W_{dmd}$ Single phase: $V_{LL}$ , $V_{LN}$ , A, VA, W, var, PF	System: kWh, kvarh, $V_{LL}$ , An, PF, W, var, VA, $W_{dmd}$ , $V_{Admd}$ , Hz, hour meter Max: A, $A_{dmd}$ , $W_{dmd}$ Single phase: $V_{LL}$ , $V_{LN}$ , A, $A_{dmd}$ , PF, W, var, VA	System: kWh, kvarh, $V_{LL}$ , $V_{LN}$ , An, PF, W, var, VA, $W_{dmd}$ , $V_{Admd}$ , Hz, hour meter; Max: $W_{dmd}$ , $V_{Admd}$ Single phase: $V_{LL}$ , $V_{LN}$ , A, $A_{dmd}$ , PF, W, var, VA, THD (A, V) Max: $V_{LN}$ , A, $A_{dmd}$ , W Min: $V_{LN}$ , A, PF
<b>Input specifications</b>			
Range code	400 / 660 $V_{LL}$ / 5(6) AAC [AV5] 100 / 208 $V_{LL}$ / 5(6) AAC [AV6]	400 / 660 $V_{LL}$ / 5(6) AAC [AV5] 100 / 208 $V_{LL}$ / 5(6) AAC [AV6]	400 / 660 $V_{LL}$ / 5(6) AAC [AV5], 100 / 208 $V_{LL}$ / 5(6) AAC [AV6]
Accuracy	$\pm 0.5\%$ FS (V, A)	$\pm 0.5\%$ FS (V, A)	$\pm 0.5\%$ FS (V, A)
Active energy		class 1	class 1
Reactive energy		class 2	class 2
Display	LED 3x3-digit	LED 3x3-digit 8+1-digit (energies)	LED 3x3-digit 8+-digit (energies)
<b>Output specifications</b>			
Pulse output			2 (open collector) [O]
Alarm output			2 (relays) with PLC-type control function on 16 variables (AND / OR) [R]
Communication	RS485 port (on request) [S]	RS485 port (on request) [S]	RS485 port (on request) [S]
<b>General specifications</b>			
Power supply	24 VAC [A], 48 VAC [B], 115 VAC [C], 230 VAC [D], 18 to 60 VDC [3]	24 VAC [A] 48 VAC [B] 115 VAC [C] 230 VAC [D] 18 to 60 VDC [3]	18 to 60 VAC / DC [L], 90 to 260 VAC / DC [H]
Approvals / Marks	CE - cURus	CE - cURus - cCSAus	CE - cURus - cCSAus
<b>References</b>			
For ordering key details, please refer to <a href="http://www.productselection.net">www.productselection.net</a>			

# Energy management

## Multifunction meter Power analyzers

Types	WM12 96	WM14 96 Basic/Profibus	WM14 96 Advanced
-------	---------	------------------------	------------------



Dimensions HxWxD (mm)	96 x 96 x 46	96 x 96 x 46	96 x 96 x 46
Function	3-phase multifunction power indicator. 96 x 96 panel mounting	3-phase power analyzer 96 x 96 panel mounting	3-phase power analyzer. 96 x 96 panel mounting
Function	System: $V_{LL}$ , $V_{LN}$ , A, An, VA, $V_{Admd}$ , W, $W_{dmd}$ , var, PF, Hz Max: A, $W_{dmd}$ Single phase: $V_{LL}$ , $V_{LN}$ , A, VA, W, var, PF	System: kWh, kvarh, $V_{LL}$ , An, PF, W, var, VA, $W_{dmd}$ , $V_{Admd}$ , Hz, hour meter Max: A, $A_{dmd}$ , $W_{dmd}$ Single phase: $V_{LL}$ , $V_{LN}$ , A, $A_{dmd}$ , PF, W, var, VA	System: kWh, kvarh, $V_{LL}$ , $V_{LN}$ , An, PF, W, var, VA, $W_{dmd}$ , $V_{Admd}$ , Hz, hour meter Max: $W_{dmd}$ , $V_{Admd}$ Single phase: $V_{LL}$ , $V_{LN}$ , A, $A_{dmd}$ , PF, W, var, VA, THD Max: $V_{LN}$ , A, $A_{dmd}$ , W Min: $V_{LN}$ , A, PF

### Input specifications

Range code	400 / 660 $V_{LL}$ / 5(6) AAC [AV5], 100 / 208 $V_{LL}$ / 5(6) AAC [AV6]	400 / 660 $V_{LL}$ / 5(6) AAC [AV5], 100 / 208 $V_{LL}$ / 5(6) AAC [AV6]	400 / 660 $V_{LL}$ / 5(6) AAC [AV5], 100 / 208 $V_{LL}$ / 5(6) AAC [AV6]
Accuracy	$\pm 0.5\%$ FS (V, A)	$\pm 0.5\%$ FS (V, A)	$\pm 0.5\%$ FS (V, A)
Active energy		class 1	class 1
Reactive energy		class 2	class 2
Display	LED 3x3-digit	LED 3x3-digit 8+1-digit (energies)	LED 3x3-digit 8+1-digit (energies)

### Output specifications

Pulse output			2 (open collector) [O]
Alarm output			2 (relays) with PLC-type control function on 16 variables (AND / OR) [R]
Communication	RS485 port (on request) [S]	RS485 port (on request) [S]	RS485 port (on request) [S]



### General specifications

Power supply	24 VAC [A], 48 VAC [B], 115 VAC [C], 230 VAC [D], 18 to 60 VDC [3]	24 VAC [A], 48 VAC [B], 115 VAC [C], 230 VAC [D], 18 to 60 VDC [3], 90 to 260 AC/DC [H] DG version only	18 to 60 VAC/DC [L], 90 to 260 VAC/DC [H]
Approvals/Marks	CE - cURus	CE - cURus - cCSAus	CE - cURus - cCSAus Advanced version [AX]



### References

For ordering key details, please refer to [www.productselection.net](http://www.productselection.net)



# Energy management

	Energy analyzer	Modular power quality analyzers	
Types	EM26 96	WM30 96	WM40 96
			
Dimensions HxWxD (mm)	96 x 96 x 61	96 x 96 x 50	96 x 96 x 50
Description	3-phase energy analyzer 96 x 96 panel mounting	3-phase modular power quality analyzer 96 x 96 panel mounting	3-phase modular power quality analyzer 96 x 96 panel mounting
Function	System: $\pm$ kWh, $\pm$ kvarh, $V_{LL}$ , $V_{LN}$ , var, VA, W, $W_{dmd}$ , $VA_{dmd}$ , VA, PF, Hz, THD, hour counter, gas and water Max: $A_{dmd}$ , $W_{dmd}$ , $VA_{dmd}$ Single-phase: $V_{LL}$ , $V_{LN}$ , A, W, var, VA, PF, $A_{dmd}$ , kWh, kvarh TRMS method	System: total/partial $\pm$ kWh and $\pm$ kvarh, $V_{LN}$ , $V_{LL}$ , VA, W, var, PF, Hz, THD (V,A) Single phase: $V_{LN}$ , $V_{LL}$ , VA, A, An, W, var, PF, THD Phase-sequence-asymmetry loss	System: Total/partial $\pm$ kWh and $\pm$ kvarh (multi-tariff), $V_{LN}$ , $V_{LL}$ , VA, W, var, PF, Hz, THD, K-factor Single phase: $V_{LN}$ , $V_{LL}$ , VA, A, An (calculated or measured), W, var, PF, THD, TDD; Phase sequence-asymmetry-loss Load profile, event stamping, data logger, utility and hour counters
<b>Input specifications</b>			
Range code	120 / 208 $V_{LL}$ [AV6], 400 / 660 $V_{LL}$ [AV5] In: 1 / 5A, I <sub>max</sub> : 10AAC	400 / 690 $V_{LL}$ AC1(2)A [AV4] 400 / 690 $V_{LL}$ AC5(6)A [AV5] 100 / 208 $V_{LL}$ AC5(6)A [AV6] 100 / 208 $V_{LL}$ AC1(2)A [AV7]	400 / 690 $V_{LL}$ AC1(2)A [AV4] 400 / 690 $V_{LL}$ AC5(6)A [AV5] 100 / 208 $V_{LL}$ AC5(6)A [AV6] 100 / 208 $V_{LL}$ AC1(2)A [AV7]
Accuracy	$\pm$ 0.5% RDG (V, A)	$\pm$ 0.2% RDG (V, A)	$\pm$ 0.2% RDG (V, A)
Active energy	class 1	Class 0.5 according to EN62053-21 Class C according to EN50470-3	Class 0.5 according to EN62053-21 Class C according to EN50470-3
Reactive energy	class 2	class 2 according to EN62053-23	class 2 according to EN62053-23
Display	LCD 3x4-digit (inst. variables) 8-digit (energies)	LCD 4x4-digit backligh 9+1-digit (energies)	LCD 4x4-digit backligh 9+1-digit (energies)
<b>Output specifications</b>			
Pulse output	3-open collector [O3] / relay [B2]	Up to 2 digital output modules	Up to 8 digital outputs
Alarm output	2-relay [R2] / open collector [O3]	Up to 4 freely configuration virtual alarms	Up to 16 freely configuration virtual alarms
Communication	RS485 (2-wire) [S1] M-BUS by means of VMU-B	Modbus RS485/232 port + RTC [S1], BACnet SMTP [B3] Modbus TCP Ethernet port [E2], BACNet-IP [B1], Ethernet/IP [E6]	Modbus RS485/232 port + RTC [S1], BACnet SMTP [B3] Optical port (ANSI type 2) Modbus TCP Ethernet port [E2], BACNet-IP [B1], Ethernet/IP [E6]
Analogue output		up to 2	up to 8
Inputs	3 digital inputs [I3]		
<b>General specifications</b>			
Power supply	18 to 60 VAC/DC [L] 90 to 260 VAC/DC [H]	18 to 60 VAC/DC [L] 90 to 260 VAC/DC [H]	18 to 60 VAC/DC [L] 90 to 260 VAC/DC [H]
Approvals / Marks	CE - cULus - MID (only H)	CE - cULus "Listed"	CE - cULus "Listed"
<b>References</b>			
For ordering key details, please refer to <a href="http://www.productselection.net">www.productselection.net</a>			

# Energy management



	Modular power quality analyzers		Modular power quality transducer
Types	WM3 96	WM5 96	PQT H
			
Dimensions HxWxD (mm)	96 x 96 x 124	96 x 96 x 124	90 x 90 x 140
Description	3-phase modular power quality analyzer 96 x 96 panel mounting	3-phase modular smart power quality analyzer 96 x 96 panel mounting	3-phase modular smart power quality transducer 96 x 96 panel mounting
Function	System: total/partial $\pm$ kWh, $\pm$ kvarh (4 tariff), $V_{L1}$ , $V_{L2}$ , An, VA, $V_{Admd}$ , W, $W_{dmd}$ , var, PF, Hz, THD Single phase: $V_{L1}$ , $V_{L2}$ , A, W, var, PF, THD	System: kWh, kvarh, $V_{L1}$ , $V_{L2}$ , An, W, var, VA, PF, Hz Single-phase: $V_{L1}$ , $V_{L2}$ , A, W, var, VA, PF, THD THD and single H up to the 63rd H (V, A)	System: kWh, kvarh, $V_{L1}$ , $V_{L2}$ , An, W, var, VA, PF, Hz Single-phase: $V_{L1}$ , $V_{L2}$ , A, W, var, VA, PF, THD THD and single H up to the 63rd H (V, A)
<b>Input specifications</b>			
Range code	400 VAC-1/5 AAC [AV5] 690 VAC-1/5 AAC [AV7]	120/208 $V_{LL}$ [AV6], 400/690 $V_{LL}$ [AV5] In: 1/5A, I <sub>max</sub> : 10 AAC	120/208 $V_{LL}$ [AV6], 400/690 $V_{LL}$ [AV5] In: 1/5A, I <sub>max</sub> : 10 AAC
Accuracy	$\pm$ 0.5% RDG (V, A)	$\pm$ 0.2% RDG (V, A)	$\pm$ 0.2% RDG (V, A)
Active energy	1 (kWh)	Class 0.5 (EN62053-22)	Class 0.5 (EN62053-22)
Reactive energy	2 (kvarh)	Class 2 (EN62053-23)	Class 2 (EN62053-23)
Display	Matrix LCD 4x4-digit (instantaneous variables) 4x9-digit (energies)	Matrix LCD 4x4-digit (instantaneous variables) 4x9-digit (energies)	
<b>Output specifications</b>			
Pulse output	Up to 2 single / dual open collector or relay modules	Up to 16, by: single / dual or quadruple open collector or relay modules	Up to 16, by: single / dual or quadruple open collector or relay modules
Alarm output	Up to 2 single / dual open collector or relay modules	Up to 16, by: single / dual or quadruple open collector or relay modules	Up to 16, by: single / dual or quadruple open collector or relay modules
Communication	RS 422 / 485 port RS232 port + RTC	RS422 / 485, RS232+RTC modules. Optical port (ANSI C12.18/Modbus) Internet / Ethernet comm. with WEB server capability [E2]	RS422 / 485, RS232+RTC modules. Optical port (ANSI C12.18/Modbus) Internet / Ethernet comm. with WEB server capability [E2]
Analogue output	Up to 2 single / dual analog output modules	Up to 8, by single / dual (mA/V) output modules	Up to 8, by single / dual (mA/V) output modules
Inputs	Up to 3 digital inputs	Up to 12 ( $W_{dmd}$ , $V_{Admd}$ sync.; tariff, contact status reading)	Up to 12 ( $W_{dmd}$ , $V_{Admd}$ sync.; tariff, contact status reading)
<b>General specifications</b>			
Power supply	18 to 60 VAC/DC [L] 90 to 260 VAC/DC [H]	18 to 60 VAC/DC [L], 90 to 260 VAC/DC [H]	18 to 60 VAC/DC [L], 90 to 260 VAC/DC [H]
Approvals / Marks	CE - cURus - CSA	CE - cURus - CSA	CE - cURus - CSA
<b>References</b>			
For ordering key details, please refer to <a href="http://www.productselection.net">www.productselection.net</a>			

# Energy management

	Compact power transducers		DC Transducer
Types	CPT DIN	CPT DIN Advanced	CVT DIN
			
Dimensions HxWxD (mm)	83.5 x 45 x 98.5	83.5 x 45 x 98.5	89 x 71.5 x 58.5
Description	3-phase compact power transducer	3-phase compact power transducer	1-phase compact transducer for DC measurements 4 din modules
Function	4-digit data format instantaneous variable, 8+1-digit format energy variables, 5+2-digit data format hours TRMS method System: kWh, kvarh, V <sub>LL</sub> , An, PF, W, var, VA, W <sub>dmd</sub> , VA <sub>dmd</sub> , Hz, hour meter Max: W <sub>dmd</sub> Single-phase: V <sub>LL</sub> , V <sub>LN</sub> , A, Admd, PF, W, var, VA	4-digit data format instantaneous variable, 8+1-digit format energies, 5+2-digit format hours TRMS method System: kWh, kvarh, V <sub>LL</sub> , V <sub>LN</sub> , An, PF, W, var, VA, W <sub>dmd</sub> , VA <sub>dmd</sub> , Hz, hour Max: W <sub>dmd</sub> , VA <sub>dmd</sub> Single-phase: V <sub>LL</sub> , V <sub>LN</sub> , A, Admd, PF, W, var, VA, THD, (A, V) Max: V <sub>LN</sub> , A, Admd, W Min: V <sub>LN</sub> , A, PF	Single-phase AC, DC. Measurements V, A, Hz
<b>Input specifications</b>			
Range code	120 / 208 VAC [AV6], 400 / 690 VAC [AV5], 1 AAC and 5 AAC	120 / 208 VAC [AV6], 400 / 690 VAC [AV5], 1 AAC and 5 AAC	1 A / 100 VAC [AV1], 60 mVDC / 10 VDC [AV2], 5 A / 100 VAC [AV4], 5 A / 500 VAC [AV5], 200 VDC / 1 ADC [AV6],
Accuracy	±0.5% RDG (A,V)	±0.5% RDG (A,V)	±0.5% RDG (A,V)
Active energy	kWh: class 1	kWh: class 1 (EN62053-21)	
Reactive energy	kvarh: class 2	kvarh: class 2 (EN62053-23)	
<b>Output specifications</b>			
Pulse output		2 (open collector) [O2]	
Alarm output		2 (relays) with PLC-type control function on 16 variables (AND / OR) [R2]	
Communication	RS422/485 [S1], RS232 [S2]	RS422/485 [S1], RS232 [S2]	
Analogue output		Up to 3: 20 mA [A1-3], 10 VDC [V1-3]	0 to 20 mA [1], 4 to 20 mA [2], 0 to 10 V [3], 0 to ±1 V [4]
<b>General specifications</b>			
Power supply	18 to 60 VAC/DC [L], 90 to 260 VAC/DC [H]	18 to 60 VAC/DC [L], 90 to 260 VAC/DC [H]	24 VAC [A], 48 VAC [B], 115 VAC [C], 230 VAC [D]
Approvals / Marks	CE - cURus - CSA	CE - cURus - CSA	CE
<b>References</b>			
For ordering key details, please refer to <a href="http://www.productselection.net">www.productselection.net</a>			

# Energy management

## DC energy analyzers

Types	VMU-E	VMU-X
		

Dimensions	1-DIN module	1-DIN module
Description	DC energy analyzer: V, A, W, kWh	Power supply module for VMU-E unit

### Input specifications

Range code	400 VDC 20 A [AV00] (up 1000 A with external shunt) 400 VDC 1000 A [AV10] (by 10 V current sensor)
Accuracy	±0.5% RDG (V, A)
Active energy	Class 1
Display	LCD 6 digitsLCD 6 digits

### Output specifications

Pulse output	1 opto-mosfet
Alarm output	1 opto-mosfet
Communication	RS485

### General specifications

Power supply	Self power supply through VMU-X unit [X]	38 to 265 VAC/DC [X]
Approvals / Marks	CE	CE

### References

For ordering key details, please refer to [www.productselection.net](http://www.productselection.net)

# Current transformers

## Current transformers

### Types

#### CTD 1Z

#### CTD 2Z

#### CTD 3Z



Dimensions HxWxD (mm)	76 x 44 x 31	86 x 56 x 42	99 x 75 x 45
-----------------------	--------------	--------------	--------------

### Input specifications

	Current transformer 1-phase AC	Current transformer 1-phase AC	Current transformer 1-phase AC
Operating frequency	48 to 62 Hz	48 to 62 Hz	48 to 62 Hz
Max. system voltage	0.72 kV	0.72 kV	0.72 kV
Rated insulation level	3 kV / 1 min @ 50 Hz	3 kV / 1 min @ 50 Hz	3 kV / 1 min @ 50 Hz
Security factor	≤ 5	≤ 5	≤ 5

### Output specifications

Secondary current	5 A	5 A	5 A
-------------------	-----	-----	-----

### General specifications

Class	1 / 3	0.5 / 1 / 3	0.5 / 1 / 3
Bus-bar size (mm) [diameter]	[22]	30 x 10 / 25 x 20 [28]	40 x 10 / 30 x 20 / 25 x 25 [33]
Standards	EN 61869-2	EN 61869-2	EN 61869-2

### Primary current

	Burden (VA)			Burden (VA)			Burden (VA)					
	Class	0.5	1	3	Class	0.5	1	3	Class	0.5	1	3
Accuracy class depending on the burden of the secondary circuit	50 A			1.5	40 A			2.5	100 A	1.5		
	60 A		1.5		50 A			2.5	150 A	1.5		
	75 A		1.5		100 A	2.5			200 A	1.5		
	80 A		1.5		150 A	2.5			250 A	2.5		
	100 A		2.5		200 A	3.75			300 A	2.5		
	125 A		2.5		250 A	5			400 A	5		
	150 A		2.5		300 A	5			500 A	5		
	200 A		3.75		400 A	5			600 A	5		
	250 A		3.75		500 A	5						
	300 A		3.75		600 A	5						

### References

For ordering key details, please refer to [www.productselection.net](http://www.productselection.net)



# Current transformers

## Current transformers

Types	TADK	TADK2	CTD 1X	CTD 2X
				
Dimensions HxWxD (mm)	115.5 x 75 x 44	115.5 x 75 x 44	66 x 46 x 30	86 x 56 x 42

Input specifications				
	Current transformer 1-phase AC	Current transformer 1-phase AC	Current transformer 1-phase AC	Current transformer 1-phase AC
Operating frequency	48 to 62 Hz	48 to 62 Hz	48 to 62 Hz	48 to 62 Hz
Max. system voltage	0.72 kV	0.72 kV	0.72 kV	0.72 kV
Rated insulation level	3 kV/1 min @ 50 Hz	3 kV/1 min @ 50 Hz	3 kV/1 min @ 50 Hz	3 kV/1 min @ 50 Hz
Security factor	≤ 5	≤ 5	≤ 5	≤ 5

Output specifications				
Secondary current	5 A standard (1 A on request)	5 A standard (1 A on request)	5 A 1 A	5 A 1 A

General specifications				
Class	0.5	0.5	0.5 / 1 / 3	0.5 / 1 / 3
Bus-bar size (mm) [diameter]	no (wounded primary)	25 x 5 (fixed bar)	20 x 5 [23]	32 x 5 / 30 x 10 / 25 x 20 / 25 x 12 [24]
Standards	IEC 60185	IEC 60185	EN 60044-1	EN 60044-1

Primary current																
	Burden (VA)			Burden (VA)			Burden (VA)			Burden (VA)						
	Class	0.5	1	3	Class	0.5	1	3	Class	0.5	1	3	Class	0.5	1	3
Accuracy class depending on the burden of the secondary circuit	1 A	10			1 A	10			50 A		1	1.25	40 A			1.25
	5 A	10			5 A	10			60 A		1	1.25	50 A			1.5
	10 A	10			10 A	10			70 A		1.5	1.75	60 A			2
	15 A	10			15 A	10			75 A	1	1.25	1.75	70 A			2.5
	25 A	10			25 A	10			80 A	1.25	1.5	2	75 A		1.75	2.5
	40 A	10			40 A	10			100 A	1.5	1.75	2.25	80 A		2	2.75
					50 A	10			120 A	1.75	2	2.5	100 A		2.5	3
					60 A	10			125 A	2	2.25	2.75	120 A		2.75	3.75
					80 A	10			150 A	2.25	2.5	3	125 A	2	2.75	3.75
					100 A	10			160 A	2.5	2.75	3.25	150 A	3	4	5
					150 A	10			200 A	3	3.25	3.75	160 A	3	4	5
					200 A	10			250 A	4.5	4.75	5.25	200 A	4	5	6.5
					250 A	10			300 A	5	5.5	6	250 A	5.5	7	8
													300 A	7	8.5	9.5
													400 A	12	13.5	14.5
													500 A	14	15.5	16.5
												600 A	17.5	19	20	

**References**

For ordering key details, please refer to [www.productselection.net](http://www.productselection.net)

# Current transformers

## Current transformers

Types	CTD 3X	CTD 4X	CTD 8V CTD 8H	CTD 8Q
				

Dimensions HxWxD (mm)	109 x 77 x 42	113 x 90 x 42	133 x 87 x 40 104 x 117 x 40	144 x 129 x 40
-----------------------	---------------	---------------	---------------------------------	----------------

### Input specifications

	Current transformer 1-phase AC	Current transformer 1-phase AC	Current transformer 1-phase AC	Current transformer 1-phase AC
Operating frequency	48 to 62 Hz	48 to 62 Hz	48 to 62 Hz	48 to 62 Hz
Max. system voltage	0.72 kV	0.72 kV	0.72 kV	0.72 kV
Rated insulation level	3 kV/1 min @ 50 Hz	3 kV/1 min @ 50 Hz	3 kV/1 min @ 50 Hz	3 kV <sub>RMS</sub> , 50 Hz, 1min
Security factor	≤ 5	≤ 5	≤ 5	≤ 5

### Output specifications

Secondary current	5 A 1 A	5 A 1 A	5 A 1 A	5 A 1 A
-------------------	------------	------------	------------	------------

### General specifications

Class	0.5 / 1 / 3	0.5 / 1 / 3 / 5P5	0.5 / 1 / 3	0.5
Bus-bar size (mm) [diameter]	51 x 15 / 40 x 20 / 32 x 32 / 40 x 20 [41]	64 x 20 / 51 x 43 / [51]	80 x 30	55 x 100
Standards	EN 60044-1	EN 60044-1	EN 60044-1	EN 60044-1

### Primary current



	Burden (VA)			Burden (VA)			Burden (VA)			Burden (VA)					
	Class	0.5	1	3	Class	0.50	1	3	5	Class	0.5				
Accuracy class depending on the burden of the secondary circuit	50 A			1.75	150 A			2.5	5	150 A		2	1000 A	15	
	60 A			2	200 A			3.25	6	200 A		4	1500 A	15	
	70 A			2.25	250 A	2.5		4.5		250 A		5	2000 A	15	
	75 A			3	300 A	3		4		300 A		2	2500 A	15	
	80 A			3	400 A	6		9		400 A	3	5	8	3000 A	15
	100 A		2	3.5	500 A	10		12.5		500 A	5	7	10	4000 A	15
	120 A		2.25	4	600 A	11		13.5		600 A	6	10	12		
	125 A		2.5	4.5	700 A	12.5		15		700 A	6	10	12		
	150 A	2.25	3	6	750 A	13		15.5		750 A	8	12	15		
	160 A	2.5	3.5	6.5	800 A	14		16.5		800 A	8	12	15		
	200 A	3	4.5	8.5	1000 A	17.5		20		1000 A	10	15	20		
	250 A	3.5	6.5	10.5	1200 A	20		22.5		1200 A	12	15	20		
	300 A	7	10	13	1250 A	20		22.5		1250 A	12	15	20		
	400 A	9	14	17	1500 A	27.5		30		1500 A	15	20	25		
	500 A	14	18	21	1600 A	27.5		30		1600 A	15	20	25		
	600 A	17	21	24						2000 A	20	25	30		
700 A	22	26	29						2500 A	25	30	40			
750 A	24	28	31												
800 A	25	29	32												

### References

For ordering key details, please refer to [www.productselection.net](http://www.productselection.net)

# Current transformers

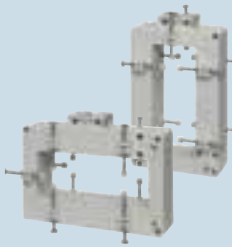
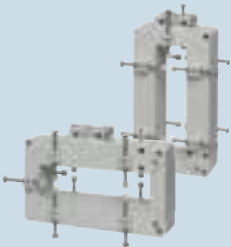
## Current transformers

Types	CTD 9V CTD 9H	CTD 10V CTD 10H	CTD 11V CTD 11H	CTD 12V CTD 12H
				
Dimensions HxWxD (mm)	178 x 92 x 40 109 x 162 x 40	178 x 107 x 40 124 x 162 x 40	178 x 98 x 40 115x160x40	178 x 125 x 40 140 x 157 x 40

### Input specifications

	Current transformer 1-phase AC	Current transformer 1-phase AC	Current transformer 1-phase AC	Current transformer 1-phase AC
Operating frequency	48 to 62 Hz	48 to 62 Hz	48 to 62 Hz	48 to 62 Hz
Max. system voltage	0.72 kV	0.72 kV	0.72 kV	0.72 kV
Rated insulation level	3 kV / 1 min @ 50 Hz	3 kV / 1 min @ 50 Hz	3 kV <sub>RMS</sub> , 50 Hz	3 kV <sub>RMS</sub> , 50 Hz
Security factor	≤ 5	≤ 5	≤ 5	≤ 5

### Output specifications

Secondary current	5 A 1 A	5 A 1 A	5 A 1 A	5 A 1 A
-------------------	------------	------------	------------	------------

### General specifications

Class	0.5 / 1 / 3	0.5 / 1 / 3	0.5	0.5
Bus-bar size (mm)	125 x 35	125 x 50	125 x 37	125 x 53
Standards	EN 60044-1	EN 60044-1	EN 60044-1	EN 60044-1

### Primary current

	Burden (VA)			Burden (VA)			Burden (VA)		Burden (VA)	
	Class	0.5	1	3	Class	0.50	1	3	Class	0.5
Accuracy class depending on the burden of the secondary circuit	400 A		3	6	400 A	1	7	10	1000 A	15
	500 A	2	4	8	500 A	3	10	14	1500 A	15
	600 A	4	6	10	600 A	5	12	17	2000 A	15
	700 A	4	8	10	700 A	8	15	20	2500 A	15
	750 A	4	8	10	750 A	10	15	20	3000 A	15
	800 A	4	8	10	800 A	10	15	20	4000 A	15
	1000 A	6	10	13	1000 A	12	20	25		
	1200 A	8	12	15	1200 A	15	25	30		
	1250 A	8	12	15	1250 A	15	25	30		
	1500 A	10	15	18	1500 A	20	30	40		
	1600 A	10	15	18	1600 A	20	30	40		
	2000 A	15	20	24	2000 A	25	40	50		
	2500 A	20	25	30	2500 A	30	50	60		
3000 A	25	30	35	3000 A	30	50	60			
3200 A	25	30	35	3200 A	30	50	60			

### References

For ordering key details, please refer to [www.productselection.net](http://www.productselection.net)

# Current transformers

## Split core current transformers

### Types

#### CTD 5S

#### CTD 6S

#### CTD 8S



Dimensions HxWxD (mm)	94 x 83 x 40	114 x 107 x 40	133 x 87 x 40
-----------------------	--------------	----------------	---------------

### Input specifications

	Split core current transformer 1-phase AC	Split core current transformer 1-phase AC	Split core current transformer 1-phase AC
Operating frequency	48 to 62 Hz	48 to 62 Hz	48 to 62 Hz
Max. system voltage	0.72 kV	0.72 kV	0.72 kV
Rated insulation level	3 kV <sub>RMS</sub> , 50 Hz, 1min	3 kV <sub>RMS</sub> , 50 Hz, 1min	3 kV <sub>RMS</sub> , 50 Hz, 1min
Security factor	≤ 5	≤ 5	≤ 5

### Output specifications

Secondary current	5 A 1 A	5 A 1 A	5 A 1 A
-------------------	------------	------------	------------

### General specifications

Class	1	1	1
Bus-bar size (mm)	27 x 32	52 x 51	81 x 31
Standards	EN 60044-1	EN 60044-1	EN 60044-1

### Primary current

Accuracy class depending on the burden of the secondary circuit	Burden (VA)			Burden (VA)			Burden (VA)		
	Class	1	3	Class	1	3	Class	1	3
	100 A		1.5		150 A		1.5	150 A	
125 A	1.5	1.5		200 A	1.5	2	200 A		1.5
150 A	1.5	2.5		250 A	1.5	3.75	250 A		2
200 A	1.5	5		300 A	1.5	5	300 A		2
250 A	1.5	5		400 A	2.5	5	400 A	3	5
300 A	2.5	7.5		500 A	5	10	500 A	5	7
400 A	5	10		600 A	7.5	15	600 A	6	10
				700 A	7.5	15	700 A	6	10
				750 A	7.5	15	750 A	8	12
				800 A	10	15	800 A	8	12
				1000 A	10	15	1000 A	10	15
							1200 A	12	15
							1250 A	12	15
							1500 A	15	20
							1600 A	15	20
							2000 A	20	25
							2500 A	25	30

### References

For ordering key details, please refer to [www.productselection.net](http://www.productselection.net)

# Current transformers

## Split core current transformers      Active current sensor

### Types      CTD 9S      CTD 10S      ROG 400

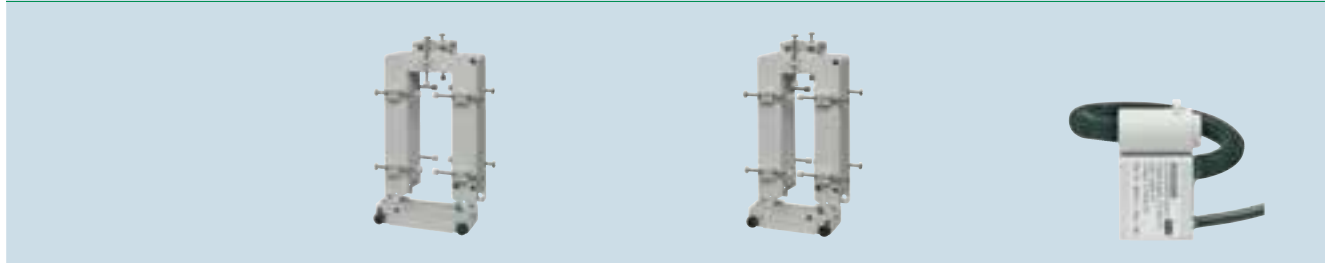

Dimensions HxWxD (mm)	178 x 92 x 40	178 x 107 x 40	54 x 29 x 17
-----------------------	---------------	----------------	--------------

### Input specifications

	Split core current transformer 1-phase AC	Split core current transformer 1-phase AC	Split core AC current sensor 1-phase AC
Operating frequency	48 to 62 Hz	48 to 62 Hz	45 to 65 Hz
Max. system voltage	0.72 kV	0.72 kV	
Rated insulation level	3 kV <sub>RMS</sub> , 50 Hz, 1min	3 kV <sub>RMS</sub> , 50 Hz, 1min	3 kV <sub>RMS</sub> , 50 Hz
Security factor	≤ 5	≤ 5	

### Output specifications

Secondary current	5 A 1 A	5 A 1 A	4 to 20 mA DC
-------------------	------------	------------	---------------

### General specifications

Class	1	1	
Bus-bar size (mm) [diameter]	125 x 35	125 x 50	[40]
Standards	EN 60044-1	EN 60044-1	

### Primary current

	Burden (VA)		Burden (VA)			
	Class	1	3	Class	1	3
Accuracy class depending on the burden of the secondary circuit	400 A		3	400 A	1	7
	500 A	2	4	500 A	3	10
	600 A	4	6	600 A	5	12
	700 A	4	8	700 A	8	15
	750 A	4	8	750 A	10	15
	800 A	4	8	800 A	10	15
	1000 A	6	10	1000 A	12	20
	1200 A	8	12	1200 A	15	25
	1250 A	8	12	1250 A	15	25
	1500 A	10	15	1500 A	20	30
	1600 A	10	15	1600 A	20	30
	2000 A	15	20	2000 A	25	40
	2500 A	20	25	2500 A	30	50
	3000 A	25	30	3000 A	30	50
	3200 A	25	30	3200 A	30	50

400 AAC

### References

For ordering key details, please refer to [www.productselection.net](http://www.productselection.net)

# Current transformers

## Split core current sensors for EM21 72V

### Types

**CTV-1X**



**CTV-2X**



**CTV-3X**



### Input / output specifications

Primary current 50/60 Hz	60 A (1-70 A)	100 A (1-120 A)	200 A
Secondary output	333 mV	333 mV	333 mV

### General specifications

Accuracy	1%	1%	1%
Linearity	0.5%	0.5%	0.5%
Phase error at nominal current	$\leq 4^\circ$	$\leq 2^\circ$	$\leq 2^\circ$
Max. system voltage	660 V	660 V	660 V
Opening angle	180°	180°	180°
Certifications	CE - cURus	CE - cURus	CE - cURus

### References

**CTV1X60A333MV**

**CTV2x100A333MV**

**CTV3X200A333MX**

### Types

**CTV-4X**



**CTV-8X**



### Input / output specifications

Primary current 50/60 Hz	400 A (20-480 A max)	800 A (1-1000 A max)
Secondary output	333 mV	333 mV

### General specifications

Accuracy	1%	1%
Linearity	0.5%	
Phase error at nominal current	$\leq 2^\circ$	$\leq 2^\circ$
Max. system voltage	660 V	660 V
Opening angle	180°	
Certifications	CE - cURus	CE - cURus





### References

**CTV4X400A333MV**

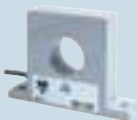

**CTV8X800A333MV**

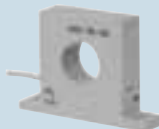
# Current transformers

## Current transformers for monitoring relays

Types	MI	MP	A 82	E 83
				
Dimensions HxWxD (mm)	45 x 52 x 16 [5 / 20] 67.5 x 95 x 20 [100 / 500]	45 x 120 x 16 [5 / 20] 114 x 150 x 23 [100 / 500]	67.5 x 95 x 20	56 x 22.5 x 49
Function	1-phase AC. Output voltage. Cable hole	3-phase AC. Output voltage. Cable hole	1-phase AC. Output 0 / 4-20 mA DC, 0-10 VDC (A82-30). Cable hole. Led indication	1-phase AC. Output 4-20 mA DC. Cable hole. DIN-rail mounting
<b>Input specifications</b>				
Input current	0.5 - 5 AAC [5] 2 - 20 AAC [20] 10 - 100 AAC [100] 50 - 500 AAC [500]	0.5 - 5 AAC [5] 2 - 20 AAC [20] 10 - 100 AAC [100] 50 - 500 AAC [500]	0 - 25 AAC [25] 0 - 50 AAC [50] 0 - 100 AAC [100] 0 - 250 AAC [250] 0 - 500 AAC [500]	0 - 5 AAC 0 - 10 AAC 0 - 15 AAC 0 - 20 AAC 0 - 25 AAC 0 - 30 AAC 0 - 50 AAC
Max. current continuously	20 AAC [5] 50 AAC [20] 250 AAC [100] 750 AAC [500]	20 AAC [5] 50 AAC [20] 250 AAC [100] 750 AAC [500]	600 AAC	100 AAC
Dielectric voltage	6 kV ACrms	6 kV ACrms	6 kV ACrms	
<b>Output specifications</b>				
Output value	0.4 - 4 Vp The output voltage is proportional to the input current	0.4 - 4 Vp The output voltage is proportional to the highest current value in the 3 conductors which are drawn through the holes of the current metering transformer	A82 - 10: 0-20 mA DC A82 - 20: 4-20 mA DC A82 - 30: 0-10 VDC The output current (A82-10, A82-20) and voltage (A82-30) are proportional to the input current	4 - 20 mA DC The output current is proportional to the input current
Output tolerance	± 5% @ In	± 5% @ In	± 2% @ 50 Hz	± 2% @ 50 Hz
Rated insulation voltage (cable)	250 VACrms	250 VACrms	250 VACrms	
<b>General specifications</b>				
Cable hole diameter	10.5 mm [5 / 20] 27 mm [100 / 500]	3 x 12 mm [5 / 20] 3 x 27 mm [100 / 500]	27 mm	12 mm
Connection cable	2 m PVC 2 x 0.5 mm <sup>2</sup>	2 m PVC 2 x 0.5 mm <sup>2</sup>	A82-10, A82-30: 2 m, 3x0.25 m <sup>2</sup> A82-20: 2 m, 2x0.25 m <sup>2</sup>	Screw terminal 2 x 1.5 mm <sup>2</sup>
Operating temperature	-20°C to +60°C	-20°C to +60°C	-20°C to +50°C	-20°C to +50°C
<b>References</b>				
	MI 5	MP 3005	A 82-XX 25	E 83-20 50
	MI 20	MP 3020	A 82-XX 50	
	MI 100	MP 3100	A 82-XX 100	
	MI 500	MP 3500	A 82-XX 250	
			A 82-XX 500	
			XX = 10: 0-20 mA DC = 20: 4-20 mA DC = 30: 0-10 VDC	



# Energy monitoring solution

	Aggregation server	Aggregation server
Types	Em <sup>2</sup> -Server	VMU-Y EM
		
Dimensions		2-DIN module
Description	Em <sup>2</sup> -Server is a cloud solution capable of aggregating information from up to 100 installations powered by VMU-C EM units. Data from the plants are transmitted through Internet, stored inside the embedded database and presented by the integrated web interface. Em <sup>2</sup> -Server + VMU-C EM is a solid, reliable and plug'n play architecture aimed at managing multiple sites projects	VMU-Y EM is an embedded solution capable of aggregating information from up to 10 installations powered by VMU-C EM units. Data from the plants are transmitted through Internet, stored inside the embedded database and presented by the integrated web interface. VMU-Y EM + VMU-C EM is a solid, reliable and plug'n play architecture aimed at managing multi-site installations
Type	Virtual Machine Software	Micro PC
Storage memory		32 GB
Back-up memory		Micro-SD / Micro-SDHC / USB
<b>Compatibility</b>		
Host Operating System	Operating system compatible with VMWARE 64 bit technology	
Virtual Machine Compatibility	VMWARE 64 bit	
Hardware compatibility	64 bit architecture compatible with VMWARE 64 bit	
Cloud compatibility	Hosting providers compatible with VMWARE technology	
<b>Software/Firmware specification</b>		
Data acquisition	By means of Carlo Gavazzi's DP (Data push) protocol	By means of Carlo Gavazzi's DP (Data push) protocol
Integrated operating system	64 bit Linux	Embedded Linux
Integrated Data Base	Industrial class SQL relational database	Industrial class SQL relational database
User Interface	Integrated multi-user, multilingual web interface	Integrated multi-user, multilingual web interface
<b>LED</b>		
Status and colour	One led with different colors for modem communication, data synchronization, alarms and power supply	One led with different colors for modem communication, data synchronization, alarms and power supply
<b>Communication port and Output specifications</b>		
Ethernet		1 port for Internet / LAN connection
USB		1 USB "A" (for USB stick) and 1 USB "mini-A" (service port)
<b>Connections</b>		
Ethernet		RJ-45 connector (10 / 100 Base-T)
USB		High Speed USB 2.0
<b>General specifications</b>		
Managed VMU-C PV units	From 20 to 100	Up to 10
Software installation	By DVD containing the Em <sup>2</sup> -Server Virtual machine	
Licensing	Perpetual license based on connected VMU-C EM units	
Voltage supply		From 12 to 28 VDC
Power consumption		≤ 5 W
Approvals / Marks		CE - cULus listed
<b>References</b>		
For ordering key details, please refer to <a href="http://www.productselection.net">www.productselection.net</a>		

For ordering key details, please refer to [www.productselection.net](http://www.productselection.net)





# Energy monitoring solution

	Web-server	Modem
<b>Types</b>	<b>VMU-C EM</b>	<b>VMU-W</b>
		
<b>Dimensions</b>	2-DIN module	2-DIN module
<b>Description</b>	Web-server which controls and supervises any electrical installation acquiring information from energy meters, power analyzers and VMU I/O modules. It provides information via Internet, so data are available anywhere	Modem based on "UMM" (Universal Mobile Modem) communication technology for data communication when wired Internet is not available. Suitable to be used in combination with VMU-C only
<b>Type</b>	Micro PC	Universal Mobile Modem
<b>Storage memory</b>	4 GB	
<b>Back-up memory</b>	Micro-SD / Micro-SDHC / USB	
<b>Mobile communication specifications</b>		
<b>SIM card</b>		SIM (25 x 15 mm) for data communication (M2M)
<b>Compatibility</b>		Modem compatible with quad-band GSM-GPRS-EDGE standards; dual-band UMTS-HSPA
<b>Supported services</b>		Internet communication; SMS
<b>Communication port and Output specifications</b>		
<b>RS485</b>	1 port for VMU I/O modules, 1 port for power analyzers and energy meters	
<b>Ethernet</b>	1 port for Internet / LAN connection	
<b>USB</b>	1 USB "A" (for USB stick) and 1 USB "mini-A" (service port)	
<b>LED</b>		
<b>Status and colour</b>	One LED with different colours for internal BUS communication, communication ports, alarms and power supply	Single colour green for ON/OFF Single colour blue for communication link status
<b>Antenna</b>		
<b>Connector</b>		RP-SMA female
<b>Type</b>		Stilo antenna included (available cable connected adhesive mount antenna as option)
<b>Connections</b>		
<b>RS485</b>	3 screw terminals per port	
<b>Ethernet</b>	RJ-45 connector (10 / 100 Base-T)	
<b>USB</b>	High Speed USB 2.0	
<b>Power supply</b>		
<b>Voltage supply</b>	From 12 to 28 VDC	From 12 to 28 VDC
<b>Power consumption</b>	≤ 5 W	≤ 5 W
<b>Approvals/Marks</b>		
	CE - cULus listed	CE - cULus listed - R&TTE 99 / 5 / CE, FCC / IC / PTCRB
<b>References</b>		
For ordering key details, please refer to <a href="http://www.productselection.net">www.productselection.net</a>		

# Energy monitoring solution

## VMU I/O optional modules

Types	VMU-M EM	VMU-P EM	VMU-O EM
			
Dimensions	1-DIN module	1-DIN module	1-DIN module
Description	Master unit 6-DGT readout	Environment variable measurement unit	Inputs / outputs unit

Function	VMU-M performs the local bus management of VMU-P both measuring units and VMU-O I/O unit	2 temperatures, 1 analogue and 1 pulse rate output	VMU-O allows to add, for every single unit, available in the local bus two digital inputs and two relay outputs
----------	--	--	---

### Input specifications

Range code	2 Pt100 or Pt1000, 3-wires (-50.0 to +200.0°C) or one digital input and one pulse input, for local management	2 Pt100 or Pt1000, 3-wires 1 analogue input (20 mA or 120 mV). 1 pulse rate input (0 to 1000 Hz max.) [2TIW]	2 digital inputs for "Protection trip detection or others"
Accuracy	±(0.5%RDG + 5DGT)	±(0.2%RDG + 1DGT)	

### Output specifications

Alarm	Real and virtual alarm management of all variables coming from VMU-M and VMU-P with local event logging		2 digital outputs for alarm notification of local alarms or as a digital input status changing. SPST relay type
Serial communication	Local bus: up to 1 VMU-P and 3 VMU-O units RS485 communication port (Modbus)	Local bus: one VMU-P unit per bus	Local bus: up to 3 VMU-O units
Others		Front multicolour LED to show the status of the unit	Front multicolour LED to show the status of the unit



### General specifications

Power supply	12 to 28 VDC power supply	Self-power supply from VMU-M unit	Self-power supply from VMU-M unit
Approvals / Marks	cULus approved	cULus approved	cULus approved



### References

For ordering key details, please refer to [www.productselection.net](http://www.productselection.net)

# PV monitoring solution



	Aggregation server	Aggregation server
Types	Eos-Server	VMU-Y PV
		
Dimensions		2-DIN module
Description	Eos-Server is a cloud solution capable of aggregating information from up to 100 PV plants powered by VMU-C PV units. Data from the plants are transmitted through Internet, stored inside the embedded database and presented by the integrated web interface. Eos-Server + VMU-C PV is a solid, reliable and plug'n play architecture aimed at managing portfolios of plants	VMU-Y PV is an embedded solution capable of aggregating information from up to 10 PV plants powered by VMU-C PV units. Data from the plants are transmitted through Internet, stored inside the embedded database and presented by the integrated web interface. VMU-Y PV + VMU-C PV is a solid, reliable and plug'n play architecture aimed at managing portfolios of plants
Type	Virtual Machine Software	Micro PC
Storage memory		32 GB
Back-up memory		Micro-SD / Micro-SDHC / USB
<b>Compatibility</b>		
Host operating system	Operating system compatible with VMWARE 64 bit technology	
Virtual machine compatibility	VMWARE 64 bit	
Hardware compatibility	64 bit architecture compatible with VMWARE 64 bit	
Cloud compatibility	Hosting providers compatible with VMWARE technology	
<b>Software/Firmware specification</b>		
Data acquisition	By Means of Carlo Gavazzi's DP protocol	By Means of Carlo Gavazzi's DP (Data push) protocol
Integrated operating system	64 bit Linux	Embedded Linux
Integrated Data Base	Industrial class SQL relational database	Industrial class SQL relational database
User Interface	Integrated multi-user, multilingual web interface	Integrated multi-user, multilingual web interface
<b>LED</b>		
Status and colour	One led with different colors for modem communication, data synchronization, alarms and power supply	One led with different colors for modem communication, data synchronization, alarms and power supply
<b>Communication port and Output specifications</b>		
Ethernet		1 port for Internet / LAN connection
USB		1 USB "A" (for USB stick) and 1 USB "mini-A" (service port)
<b>Connections</b>		
Ethernet		RJ-45 connector (10 / 100 Base-T)
USB		High Speed USB 2.0
<b>General specifications</b>		
Managed VMU-C PV units	From 20 to 100	Up to 10
Software installation	By DVD containing the Eos-Server Virtual machine	
Licensing	perpetual license based on connected VMU-C PV units	
Voltage Ssply		From 12 to 28 VDC
Power consumption		≤ 5 W
Approvals / Marks		CE - cULus listed
<b>References</b>		
For ordering key details, please refer to <a href="http://www.productselection.net">www.productselection.net</a>		

# PV monitoring solution

	Web-server	Modem
<b>Types</b>	<b>VMU-C PV</b>	<b>VMU-W</b>
		
Dimensions HxWxD (mm)	2-DIN module	2-DIN module
Description	VMU-C is a Web-server which controls and supervises a photovoltaic installation acquiring information from Eos-Array groups, inverters and energy meters. The VMU-C provides information via Internet so data are available wherever you are. VMU-C is also capable of M2M communication by scheduling FTP uploads or by interacting with its HTTP API.	Modem based on "UMM" (Universal Mobile Modem) communication technology for data communication when wired Internet is not available. This unit is suitable to be used in combination with VMU-C only.
Type	Micro PC	Universal Mobile Modem
Storage memory	4 GB	
Back-up memory	Micro-SD / Micro-SDHC / USB	
<b>Mobile communication specifications</b>		
SIM card		SIM (25 x 15 mm) for data communication (M2M)
Compatibility		Modem compatible with quad-band SM-GPRS-EDGE standards; dual-band UMTS-HSPA
Supported services		Internet communication; SMS
<b>LED</b>		
Status and colour	One led with different colors for internal BUS communication, communication ports, alarms and power supply	Single colour green for ON/OFF. Single colour blue for communication link status
<b>Communication port and Output specifications</b>		
RS485	1 port for Eos-Arrays, 1 port for inverters and energy meters	
Ethernet	1 port for Internet / LAN connection	
USB	1 USB "A" (for USB stick) and 1 USB "mini-A" (service port)	
<b>Antenna</b>		
Connector	RP-SMA female	
Type	Stilo antenna included (available cable connected adhesive mount antenna as option)	
<b>Connections</b>		
RS485	3 screw terminals per port	
Ethernet	RJ-45 connector (10 / 100 Base-T)	
USB	High Speed USB 2.0	
<b>General specifications</b>		
Voltage supply	From 12 to 28 VDC	From 12 to 28 VDC
Power consumption	≤ 5 W	≤ 5W
Approvals / Marks	CE - cULus listed	CE - cULus listed - R&TTE 99 / 5 / CE, FCC / IC / PTCRB
<b>References</b>		
For ordering key details, please refer to <a href="http://www.productselection.net">www.productselection.net</a>		

# PV monitoring solution

## EOS-Array solar control solution

Types	VMU-M	VMU-S	VMU-P
			
Dimensions HxWxD (mm)	1-DIN module	1-DIN module	1-DIN module
Description	Master unit 6-DGT readout	String unit, with built-in protection fuseholder	Environment variable measurement unit
Function	VMU-M performs the local bus management of VMU-S, VMU-P both measuring units and VMU-O I/O unit	Variables measuring unit, DC current, voltage, power and energy metering. String control and efficiency measurement	PV module temperature, air temperature, sun irradiation and wind speed metering

### Input specifications

Range code	2 Pt100 or Pt1000, 3-wire (-50.0°C to +200.0°C) or one digital input and one pulse input. [T2]	Direct connections 16 A / 1000 VDC [AV10]. Measurements: V, A, W, Wh	2 Pt100 or Pt1000, 3-wire (PV and air temperature). 1 irradiance input (up to 120 mV [2TIW] or 4-20 mA [2TCW]). 1 wind speed input (0 to 1000 Hz max.)
Accuracy	±(0.5% RDG + 5DGT)	±(0.5% RDG + 2DGT)	±(0.2% RDG + 1DGT)

### Output specifications

Alarm	Real and virtual alarm management of all variables coming from VMU-M, VMU-S, and VMU-P with event logging		
Serial communication	Local bus: up to 15 mixed VMU-S, VMU-P and VMU-O units RS485 communication port (Modbus) [S1]	Local bus: up to 15 VMU-S units in the same bus [S]	Local bus: one VMU-P unit per bus [S]
Others	Data logger (V, A, W, PV cell and air temperature, irradiation, wind speed) DC/AC efficiency	Diagnostics functions: antitheft control, fuse blow detection, wrong PV panel connection. Front multicolour LED to show the status of the unit	Front multicolour LED to show the status of the unit

### General specifications

Power supply	12 to 28 VDC power supply [A]	Self-power supply from VMU-M unit [X]	Self-power supply from VMU-M unit [X]
Approvals / Marks	CE - cULus Listed	CE - cULus Listed	CE - cULus Listed

### References

For ordering key details, please refer to [www.productselection.net](http://www.productselection.net)

# PV monitoring solution

## EOS-Array solar control solution

### Types

#### VMU-O...AT

#### VMUAT



Dimensions HxWxD (mm)	1-DIN module	1-DIN module
Description	Inputs/outputs unit	Optical fiber anti-theft sensor
Function	VMU-O allows to add, for every single unit, available in the local bus two digital inputs and two relay outputs	

### Input specifications

Range code	2 digital inputs for "Protection trip detection or others" [R2]	Optical fiber plastic type PF0221000
------------	---	--------------------------------------

### Output specifications

Alarm	2 digital outputs for alarm notification as string alarm or as a digital input status changing. SPST relay type. [R2]	NPN or PNP
Serial communication	Local bus: up to 7 VMU-O units	
Others	Front multicolour LED to show the status of the unit	

### General specifications



Power supply	Self-power supply from VMU-M unit [X]	Self power supply through VMU-O AT unit [X]
Approvals / Marks	CE - cULus Listed	CE

### References

For ordering key details, please refer to [www.productselection.net](http://www.productselection.net)



# PV monitoring solution

## EOS-Array Lite solar control solution

Types	VMU-ML	VMU-S0	VMU-P
			
Dimensions HxWxD (mm)	1-DIN module	1-DIN module	1-DIN module
Description	Master unit 6-DGT readout	String unit, with built-in protection fuseholder	Environment variable measurement unit
Function	VMU-ML performs the local bus management of VMU-S0, VMU-P both measuring units and VMU-O output unit	Variables measuring unit, DC current and voltage	PV module temperature, air temperature, sun irradiation
<b>Input specifications</b>			
Range code		Direct connections 16 A / 1000 VDC [AV10]. Measurements: V, A	1 Pt100 or Pt1000, 3-wire (PV and air temperature). 1 irradiation input (up to 120 mV [1TI] or 4 - 20 mA [2TCW])
Accuracy		±(0.5%RDG + 2DGT)	±(0.2%RDG + 1DGT)
<b>Output specifications</b>			
Alarm	Single real or virtual alarm management of all variables coming from VMU-ML, VMU-S0, and VMU-P with event logging		
Serial communication	Local bus: up to 15 mixed VMU-S0, VMU-P and VMU-O units RS485 communication port (Modbus) [S1]	Local bus: up to 15 VMU-S0 units in the same bus [S]	Local bus: one VMU-P unit per bus [S]
Others	Front dual colour LED to show the status of the unit	Diagnostics functions: wrong PV panel connection	Front multicolor LED to show the status of the unit
<b>General specifications</b>			
Power supply	12 to 28 VDC power supply [A]	Self-power supply from VMU-ML unit [X]	Self-power supply from VMU-ML unit [X]
Approvals / Marks	CE - cULus Listed	CE - cULus Listed	CE - cULus Listed
<b>References</b>			
For ordering key details, please refer to <a href="http://www.productselection.net">www.productselection.net</a>			

# Monitoring relays

## Current relays

Types	DIA 01 PIA 01	DIA 53	DIB 01 PIB 01
			
Dimensions HxWxD (mm) DIN RAIL housing Plug-in housing	80 x 22.5 x 99.5 [D] 80 x 36 x 94 [P]	81 x 17.5 x 67.2 [Mini-D]	80 x 22.5 x 99.5 [D] 80 x 36 x 94 [P]
Function	Over current monitoring relay. 1-phase AC / DC. Direct input or on CT 5A. Setpoint adjustable. Hysteresis adjustable	Over current monitoring relay. 1-phase AC. Setpoint adjustable. 2-wire connection. Reaction time < 50 ms for F versions. 12 mm hole for insulated current carrying wire	Over or under current monitoring relay. 1-phase AC / DC TRMS. Direct input or on CT 10A. Setpoint adjustable. Hysteresis adjustable. Delay time adjustable. 12 mm hole for insulated current carrying wire [100 A]

## Input specifications

Measuring range	0.5 - 5 AAC/DC	2 - 20 AAC [20A] 5 - 50 AAC [50A] 10 - 100 AAC [100A]	0.1 - 5 mAAC/DC [5 MA] 1 - 50 mAAC/DC [50 MA] 10-500 mAAC/DC [500 MA] 0.1-5 AAC/DC [5 A] 1-10 AAC/DC [10 A] 2-100 AAC [100 A]
-----------------	----------------	---	--

## Output specifications

	1 x SPDT relay	Static output	1 x SPDT relay
Max. load AC1	8 A / 250 VAC		8 A / 250 VAC
Max. load DC12	5 A / 24 VDC	100 mA	5 A / 24 VDC
Electrical life	>1 x 10 <sup>5</sup> operations		>1 x 10 <sup>5</sup> operations

## General specifications

Power supply	24-48 VAC/DC [D48] 115 / 230 VAC [B23]	40 VDC max. Powered by the measured current	24-48 VAC/DC [D48] 115 / 230 VAC [B23] 24 VDC / 24-240 VAC [M24]
Approvals / Marks	CE - UL - CSA	CE - UL - CSA	CE - UL - CSA

## References



DIA01C D48 5A	DIA53S 724 20A	DIB01C ... 5MA
PIA01C D48 5A	DIA53S 724 50A	DIB01C ... 50MA
DIA01C B23 5A	DIA53S 724 100A	DIB01C ... 500MA
PIA01C B23 5A	DIA53S 724 20A F	DIB01C ... 5A
	DIA53S 724 50A F	DIB01C ... 10A
	DIA53S 724 100A F	DIB01C M24 100A
		PIB01C ... 5MA
		PIB01C ... 50MA
		PIB01C ... 500MA
		PIB01C ... 5A
		PIB01C ... 10A

... = insert code for Power Supply







# Monitoring relays

## Current relays

Types	DIB 71	DIB 02 PIB 02	DIC 01 PIC 01
			
Dimensions HxWxD (mm)	81 x 35.5 x 67.2 [Mini-D]	80 x 22.5 x 99.5 [D] 80 x 36 x 94 [P]	80 x 45 x 99.5 [D] 80 x 36 x 94 [P]
DIN RAIL housing			
Plug-in housing			
Function	Over or under current monitoring relay. 1-phase AC/DC TRMS. Direct input or on CT 5 A. Setpoint adjustable. Hysteresis adjustable. Delay time adjustable	Over or under current monitoring relay. 1-phase AC/DC TRMS. Input on shunt or CT MI / MP. Setpoint adjustable. Hysteresis adjustable. Delay time adjustable	Process signal monitoring relay. 1-phase AC/DC TRMS. Direct input, CT A82 or CT MI / MP. 2 setpoints separately adjustable. Hysteresis adjustable. 2 delay functions separately adjustable
<b>Input specifications</b>			
Measuring range	0.1 - 5 mAAC/DC [5MA] 1 - 50 mAAC/DC [50MA] 10 - 500 mAAC/DC [500 MA] 0.1 - 5 AAC/DC [5A]	6 - 150 mVAC/DC 0.4 - 4 V <sub>P</sub>	0.5 - 20 mAAC/DC 0.1 - 10 VAC/DC 0.4 - 4 V <sub>P</sub>
<b>Output specifications</b>			
	1 x SPDT relay	1 x SPDT relay	1 x SPDT relay [P] 2 x SPDT relays [D]
Max. load AC1	5 A / 250 VAC	8 A / 250 VAC	5 A / 250 VAC
Max. load DC12	5 A / 24 VDC	5 A / 24 VDC	5 A / 24 VDC
Electrical life	>1 x 10 <sup>5</sup> operations	>1 x 10 <sup>5</sup> operations	>1 x 10 <sup>5</sup> operations
<b>General specifications</b>			
Power supply	24 / 48 VAC [B48] 115 / 230 VAC [B23]	24 - 48 VAC/DC [D48] 115 / 230 VAC [B23]	24 - 48 VAC/DC [D48] 115 / 230 VAC [B23]
Approvals / Marks	CE - UL - CSA	CE - UL - CSA	CE - UL - CSA
<b>References</b>			
	DIB71C B48 5MA	DIB02C D48 150MV	DIC01D D48 AV0
	DIB71C B48 50MA	PIB02C D48 150MV	PIC01C D48 AV0
	DIB71C B48 500MA	DIB02C B23 150MV	DIC01D B23 AV0
	DIB71C B48 5A	PIB02C B23 150MV	PIC01C B23 AV0
	DIB71C B23 5MA		
	DIB71C B23 50MA		
	DIB71C B23 500MA		
	DIB71C B23 5A		





# Monitoring relays

## Voltage relays

Types	DUA 01 PUA 01	DUA 52	DUA 55	DUB 01 PUB 01
				
Dimensions HxWxD (mm) DIN RAIL housing Plug-in housing	80 x 22.5 x 99.5 [D] 80 x 36 x 94 [P]	81 x 17.5 x 67.2 [Mini-D]	81 x 17.5 x 67.2 [Mini-D]	80 x 22.5 x 99.5 [D] 80 x 36 x 94 [P]
Function	Over current and voltage monitoring relay. 1-phase AC/DC. Setpoint adjustable. Hysteresis adjustable	Under voltage monitoring relay for DC battery. Setpoint adjustable. Hysteresis adjustable. Measures its own power supply	Over and under voltage monitoring relay. 1-phase (measures its own power supply) AC TRMS	Over or under voltage monitoring relay. 1-phase AC/DC TRMS. Setpoint adjustable. Hysteresis adjustable. Delay time adjustable.
<b>Input specifications</b>				
Measuring range	2 - 500 VAC/DC 0.4 - 4 V <sub>P</sub>	8 - 28 VDC [724] 38 - 58 VDC [748]	208 / 220 / 230 / 240 VAC	0.1 - 10 VAC/DC [10 V] 2-500 VAC/DC [500 V]
<b>Output specifications</b>				
	1 x SPDT relay	1 x SPDT relay	1 x SPDT relay	1 x SPDT relay
Max. load AC1	8 A / 250 VAC	5 A / 250 VAC	5 A / 250 VAC	8 A / 250 VAC
Max. load DC12	5 A / 24 VDC	5 A / 24 VDC	5 A / 24 VDC	5 A / 24 VDC
Electrical life	>1 x 10 <sup>5</sup> operations	>1 x 10 <sup>5</sup> operations	>1 x 10 <sup>5</sup> operations	>1 x 10 <sup>5</sup> operations
<b>General specifications</b>				
Power supply	24 - 48 VAC/DC [D48] 115 / 230 VAC [B23]	8 - 28 VDC [724] 38 - 58 VDC [748]	208 - 480 VAC	24-48 VAC/DC [D48] 115 / 230 VAC [B23]
Approvals / Marks	CE - UL - CSA	CE - UL - CSA	CE - UL - CSA	CE - UL - CSA
<b>References</b>				
	<b>DUA01C D48 500V</b>	<b>DUA52 C724</b>	<b>DUA55 CM44</b>	<b>DUB01C D48 10V</b>
	<b>PUA01C D48 500V</b>	<b>DUA52 C748</b>		<b>DUB01C D48 500V</b>
	<b>DUA01C B23 500V</b>			<b>PUB01C D48 10V</b>
	<b>PUA01C B23 500V</b>			<b>PUB01C D48 500V</b>
				<b>DUB01C B23 10V</b>
				<b>DUB01C B23 500V</b>
				<b>PUB01C B23 10V</b>
				<b>PUB01C B23 500V</b>





# Monitoring relays

## Voltage relays

Types	DUB 71	DUB 02 PUB 02	DUB 03 PUB 03	DUC 01 PUC 01
				
Dimensions HxWxD (mm)	81 x 35.5 x 67.2 [Mini-D]	80 x 22.5 x 99.5 [D] 80 x 36 x 94 [P]	80 x 22.5 x 99.5 [D] 80 x 36 x 94 [P]	80 x 45 x 99.5 [D] 80 x 36 x 94 [P]
DIN RAIL housing				
Plug-in housing				
Function	Over or under voltage monitoring relay. 1-phase AC/DC TRMS. Setpoint adjustable. Hysteresis adjustable. Delay time adjustable	Over and under voltage monitoring relay. 1-phase (measures its own power supply) AC TRMS. Over and under voltage setpoints separately adjustable. Hysteresis adjustable. Delay time adjustable (ON/OFF)	Over or under voltage monitoring relay. 1-phase (measures its own power supply) AC/DC TRMS. Setpoint adjustable. Hysteresis adjustable. Delay time adjustable	Over and under voltage monitoring relay. 1-phase AC/DC TRMS. 2 setpoints separately adjustable. Hysteresis adjustable. 2 delay functions separately adjustable
<b>Input specifications</b>				
Measuring range	0.1 - 10 VAC/DC [10 V] 2-500 VAC/DC [500 V]	24/115/230 VAC	24/48/115/240 VAC/DC	2 - 500 VAC/DC [500 V]
<b>Output specifications</b>				
	1 x SPDT relay	1 x SPDT relay	1 x SPDT relay [P]	1 x SPDT relay [C] 2 x DPDT relay [D]
Max. load AC1	5 A / 250 VAC	8 A / 250 VAC	8 A / 250 VAC	8 A / 250 VAC
Max. load DC12	5 A / 24 VDC	5 A / 24 VDC	5 A / 24 VDC	5 A / 24 VDC
Electrical life	>1 x 10 <sup>5</sup> operations	>1 x 10 <sup>5</sup> operations	>1 x 10 <sup>5</sup> operations	>1 x 10 <sup>5</sup> operations
<b>General specifications</b>				
Power supply	24/48 VAC [B48] 115 / 230 VAC [B23]	24/115/230 VAC	12 - 240 VAC/DC	24 - 48 VAC/DC [D48] 115 / 230 VAC [B23]
Approvals / Marks	CE - UL - CSA	CE - UL - CSA	CE - UL - CSA	CE - UL - CSA
<b>References</b>				
	DUB71C B48 10V	DUB02C T23	DUB03C W24	DUC01D D48 500V
	DUB71C B48 500V	PUB02C T23	PUB03C W24	PUC01C D48 500V
	DUB71C B23 10V			DUC01D B23 500V
	DUB71C B23 500V			PUC01C B23 500V

# Monitoring relays

## 3-phase voltage relays

Types	DPA 01 PPA 01	DPA 51 DPA 71	DPA 03 PPA 03	DPA 53
				
Dimensions HxWxD (mm) DIN RAIL housing	80 x 22.5 x 99.5 [D]	81 x 17.5 x 67.2 <sup>[Mini-D]</sup> 81 x 35.5 x 67.2 <sup>[Mini-D]</sup>	80 x 22.5 x 99.5 [D]	81 x 17.5 x 67.2 <sup>[Mini-D]</sup>
Plug-in housing	80 x 36 x 94 [P]		80 x 36 x 94 [P]	
Function	Phase sequence, total and partial phase loss monitoring relay. 3-phase AC (measures its own power supply). Regenerated voltage	Phase sequence, total and partial phase loss monitoring relay. 3-phase AC (measures its own power supply). Regenerated voltage	Under voltage, phase sequence, total and partial phase loss monitoring relay. 3-phase (measures its own power supply) AC TRMS	Under voltage, phase sequence, total and partial phase loss monitoring relay. 3-phase (measures its own power supply) AC TRMS

## Input specifications

Measuring range	208 - 240 VAC [M23] 208 - 415 VAC [P] [M44] 208 - 480 VAC [D] [M44] 380 - 415 VAC [P] [M48] 380 - 480 VAC [D] [M48] 380 - 600 VAC [M60] 380 - 690 VAC [M69]	208 - 240 VAC [M23] 208 - 480 VAC [M44] 380 - 480 VAC [M48]	208 - 240 VAC [M23] 380 - 415 VAC [P] [M48] 380 - 480 VAC [D] [M48] 600 - 690 VAC [M69]	208 - 240 VAC [M23] 380 - 480 VAC [M48]
-----------------	---	---	--	--

## Output specifications

	1 x SPDT relay [C] 1 x DPDT relay [D]	1 x SPDT relay [C] 1 x DPDT relay [D]	1 x SPDT relay	1 x SPDT relay
Max. load AC1	8 A / 250 VAC	5 A / 250 VAC	8 A / 250 VAC	5 A / 250 VAC
Max. load DC12	5 A / 24 VDC	5 A / 24 VDC	5 A / 24 VDC	5 A / 24 VDC
Electrical life	>1 x 10 <sup>5</sup> operations	>1 x 10 <sup>5</sup> operations	>1 x 10 <sup>5</sup> operations	>1 x 10 <sup>5</sup> operations

## General specifications



Power supply	208 - 240 VAC [M23] 208 - 415 VAC [P] [M44] 208 - 480 VAC [D] [M44] 380 - 415 VAC [P] [M48] 380 - 480 VAC [D] [M48] 380 - 600 VAC [M60] 380 - 690 VAC [M69]	208 - 240 VAC [M23] 208 - 480 VAC [M44] 380 - 480 VAC [M48]	208 - 240 VAC [M23] 380 - 415 VAC [P] [M48] 380 - 480 VAC [D] [M48] 600 - 690 VAC [M69]	208 - 240 VAC [M23] 380 - 480 VAC [M48]
Approvals / Marks	CE - UL - CSA	CE - UL - CSA	CE - UL - CSA	CE - UL - CSA

## References

DPA01D M23	DPA51C M44	DPA03C M23	DPAS3C M23
PPA01D M23	DPA71D M23	PPA03C M23	DPAS3C M48
DPA01C M44	DPA71D M48	DPA03C M48	
PPA01C M44		PPA03C M48	
DPA01D M48		DPA03C M69	
PPA01D M48			
DPA01C M60			
DPA01C M69			



# Monitoring relays

## 3-phase voltage relays

Types	DPA 55	DPB 01 PPB 01	DPB 51
			
Dimensions HxWxD (mm) DIN RAIL housing Plug-in housing	81 x 17.5 x 67.2 [Mini-D]	80 x 22.5 x 99.5 [D] 80 x 36 x 94 [P]	90 x 17.5 x 67.2 [Mini-D]
Function	Over and under voltage, phase sequence, total and partial phase loss monitoring relay. 3-phase (measures its own power supply) AC TRMS. Two tolerance voltage windows	Over and under voltage monitoring relay with phase loss and phase sequence. 3-phase +N (measures its own power supply) AC TRMS. N versions without phase sequence detection. W4 versions supplied between L and N. 2 setpoints separately adjustable. Delay time adjustable	Over and under voltage monitoring relay with phase loss, neutral loss and phase sequence. 3-phase +N (measures its own power supply) AC TRMS. 2 setpoints separately adjustable. Delay time adjustable
<b>Input specifications</b>			
Measuring range	208 - 480 VAC	208 - 240 VAC [M23] 380 - 415 VAC [P] [M48] 380 - 480 VAC [D] [M48]	208 - 480 VAC
<b>Output specifications</b>			
	1 x SPDT relay	1 x SPDT relay	1 x SPDT relay
Max. load AC1	5 A / 250 VAC	8 A / 250 VAC	5 A / 250 VAC
Max. load DC12	5 A / 24 VDC	5 A / 24 VDC	5 A / 24 VDC
Electrical life	>1 x 10 <sup>5</sup> operations	>1 x 10 <sup>5</sup> operations	>1 x 10 <sup>5</sup> operations
<b>General specifications</b>			
Power supply	208 - 480 VAC	208 - 240 VAC [M23] 380 - 415 VAC [P] [M48] 380 - 480 VAC [D] [M48] [W]	208 - 480 VAC
Approvals / Marks	CE - UL - CSA	CE - UL - CSA	CE - UL - CSA
<b>References</b>			
	DPA55C M44	DPB01C M23	DPB51C M44
		PPB01C M23	DPB51C M44T
		DPB01C M23 N	DPB51C M44B006
		PPB01C M23 N	DPB51C M44B006T
		DPB01C M48	
		PPB01C M48	
		DPB01C M48 W4	
		PPB01C M48 W4	
		DPB01C M48 N	
		PPB01C M48 N	
		DPB01C M48 N W4	
		PPB01C M48 N W4	

# Monitoring relays

## 3-phase voltage relays

Types	DPB 71	DPB 02 PPB 02	DPC 01 PPC 01
			
Dimensions HxWxD (mm) DIN RAIL housing Plug-in housing	81 x 35.5 x 67.2 [Mini-D]	80 x 22.5 x 99.5 [D] 80 x 36 x 94 [P]	80 x 45 x 99.5 [D] 80 x 36 x 94 [P]
Function	Over and under voltage monitoring relay with phase loss and phase sequence. 3-phase +N (measures its own power supply) AC TRMS. 2 setpoints separately adjustable. Delay time adjustable	Asymmetry monitoring relay with phase sequence / phase loss. 3-phase +N (measures its own power supply) AC TRMS. Adjustable asymmetry. Delay time adjustable	Over and under voltage monitoring relay with phase loss / phase sequence, asymmetry and tolerance. 3-phase +N (measures its own power supply) AC TRMS. Setpoint separately adjustable by function

### Input specifications

Measuring range	208 - 240 VAC [M23] 380 - 480 VAC [M48]	208 - 240 VAC [M23] 380 - 415 VAC [P] [M48] 380 - 480 VAC [D] [M48]	208 - 240 VAC [M23] 380 - 415 VAC [P] [M48] 380 - 480 VAC [D] [M48] 600 - 690 VAC [M69] Frequency 50 - 60 Hz 100 - 115 VAC [M11 400Hz] 208 - 240 VAC [M23 400Hz] 380 - 415 VAC [M48 400Hz] 440 - 480 VAC [M49 400Hz] 600 - 690 VAC [M69 400Hz] Frequency 50 - 400 Hz
-----------------	--	---	--

### Output specifications

Max. load AC1	1 x SPDT relay 5 A / 250 VAC	1 x SPDT relay 8 A / 250 VAC	2 x SPDT relay 8 A / 250 VAC
Max. load DC12	5 A / 24 VDC	5 A / 24 VDC	5 A / 24 VDC
Electrical life	>1 x 10 <sup>5</sup> operations	>1 x 10 <sup>5</sup> operations	>1 x 10 <sup>5</sup> operations



### General specifications

Power supply	208 - 240 VAC [M23] 380 - 480 VAC [M48]	208 - 240 VAC [M23] 380 - 415 VAC [P] [M48] 380 - 480 VAC [D] [M48]	100 - 115 VAC [M11] 208 - 240 VAC [M23] 380 - 415 VAC [P] [M48] 380 - 480 VAC [D] [M48] 440 - 480 VAC [M49] 600 - 690 VAC [M69]
Approvals / Marks	CE - UL - CSA	CE - UL - CSA	CE - UL - CSA

### References

	DPB71C M23	DPB02C M23	DPC01D M23
	DPB71C M48	PPB02C M23	PPC01D M23
		DPB02C M48	DPC01D M48
		PPB02C M48	PPC01D M48
			DPC01D M69
			DPC01D M11 400HZ
			DPC01D M23 400HZ
			DPC01D M48 400HZ
			DPC01D M49 400HZ
			DPC01D M69 400HZ

# Monitoring relays

	3-phase multifunction voltage relays		Interface protection relays
Types	DPC 71 PPC 71	DPC 02	DPC 72
			
Dimensions (mm) HxWxD			
DIN RAIL housing	81 x 35.5 x 67.2 [D]	80 x 45 x 99.5 [D]	90 x 71.6 x 66.3 [D]
Plug-in housing	81.2 x 35.5 x 75 [P]		
Function	Over and under voltage monitoring relay with phase loss / phase sequence, asymmetry and tolerance. 3-phase +N (measures its own power supply) AC TRMS. Setpoints separately adjustable by function	Over and under voltage / over and under frequency with phase loss and phase sequence monitoring relay. 3-phase+N (measures its own power supply) AC TRMS. Setpoints separately adjustable. Separately adjustable delay times. Adjustable frequency range	Digital interface protection relay with over and under voltage / over and under frequency, phase loss and phase sequence controls. Frequency derivative monitoring [B001, B003], voltage quality [B002], RS485 port, event counter, datatimestamping and auto-test function. 3-phase (measures its own power supply) AC TRMS. Setpoints separately adjustable. Separately adjustable delay times. Programmable via PC (DpcSoft free configuration software)

## Input specifications

Measuring range	208 - 240 VAC [M23] 380 - 415 VAC [P] [M48] 380 - 480 VAC [D] [M48]	Voltage: 208 - 240 VAC [M23] 380 - 415 VAC [M48] 440 - 480 VAC [M49] 600 - 690 VAC [M69] Frequency: 50 / 60 Hz	Voltage: 380-415 VAC [M48] Frequency: 45-65 Hz
-----------------	---	--	---

## Output specifications

Max. load AC1	2 x SPDT relays 5 A / 250 VAC	2 x SPDT relays 8 A / 250 VAC	1 x DPDT relays 8 A / 250 VAC
Max. load DC12	5 A / 24 VDC	5 A / 24 VDC	5 A / 24 VDC
Electrical life	>1 x 10 <sup>5</sup> operations	>1 x 10 <sup>5</sup> operations	>1 x 10 <sup>5</sup> operations

## General specifications



Power supply	208 - 240 VAC [M23] 380 - 415 VAC [P] [M48] 380 - 480 VAC [D] [M48]	208 - 240 VAC [M23] 308 - 415 VAC [M48] 440 - 480 VAC [M49] 600 - 690 VAC [M69]	308 - 415 VAC [M48]
Approvals / Marks	CE - UL - CSA	CE - UL - CSA - ENEL DK 5950 [B003]	CE - VDE 0126-1-1 [B002]

## References

DPC71D M23	DPC02D M23	DPC72D M48 B001
PPC71D M23	DPC02D M48	DPC72D M48 B002
DPC71D M48	DPC02D M49	
PPC71D M48	DPC02D M69	
	DPC02D M23 B003	
	DPC02D M48 B003	



# Monitoring relays

## Interface protection relays

Types	PI96	PI-DIN
		
Dimensions HxWxD (mm)	96 x 96 x 85.9	90 x 71.6 x 66.3
Description	Single or three-phases systems monitoring relay interface protection with energy metering and logging of max-min and avg values for: $V_{LL}$ , $V_{UV}$ , VA, VAR, PF, kWh, THD	Single or three-phases systems monitoring relay interface protection
<b>Measuring input</b>		
Voltage range	230 V <sub>LN</sub> , 400 V <sub>LL</sub>	230 V <sub>LN</sub> , 400 V <sub>LL</sub>
Frequency range	47.5 to 51.5 Hz	47.5 to 51.5 Hz
Current range	I <sub>n</sub> 5A, I <sub>max</sub> 6A (bigger currents CT)	None
Display	LCD, 4 lines 4 DGT, 1 line 10 DGT	LCD, 2 lines 4 DGT, 1 line 8 DGT
<b>Input specifications</b>		
VDE-AR-N-4105	-	2 digitals
CEI 0-21	6 digitals	4 digitals
<b>Output specifications</b>		
Type	4 x SPST relays (N.O.)	2 x SPDT relays
Max. load AC1	5 A @ 250 VAC	8 A @ 250 VAC
Serial communication protocol	RS485-RS232	RS485
Protocol	Modbus RTU	Modbus RTU
<b>General specifications</b>		
Power supply	115..230 VCA -20% +15% (48..62 Hz) Option 24 VDC -20% +10%	115..230 VCA -20% +15% (48..62 Hz) Option 24 VDC -20% +10%
Approvals / Marks	CE - CEI 0 - 21	CE - VDE V 0126-1-1:2013 - VDE AR N 4105 - CEI 0 - 21
<b>References</b>		
CEI 0-21 (AC aux power)	<b>PI960021HI6R4S1XX</b>	<b>PIDIN0021HI4R2S1XX</b>
CEI 0-21 (DC aux power)	<b>PI960021LI6R4S1XX</b>	<b>PIDIN0021LI4R2S1XX</b>
VDE V 0126-1-1:2013 (AC aux power) VDE AR N 4105 (AC aux power)		<b>PIDIN0126HI2R2S1XX</b>
VDE V 0126-1-1:2013 (DC aux power) VDE AR N 4105 (DC aux power)		<b>PIDIN0126LI2R2S1XX</b>





# Monitoring relays



	Frequency relays		Cosφ relays
Types	DFB 01 PFB 01	DFC 01	DWA 01 PWA 01
			
Dimensions HxWxD (mm)			
DIN RAIL housing	80 x 22.5 x 99.5 [D]	80 x 45 x 99.5 [D]	80 x 22.5 x 99.5 [D]
Plug-in housing	80 x 36 x 94 [P]		80 x 36 x 94 [P]
Function	Frequency monitoring relay. 1-phase AC (measures its own power supply). 2 setpoints separately adjustable. Delay time adjustable	Frequency monitoring relay. 1-phase AC (measures its own power supply). 2 setpoints separately adjustable. 2 separately adjustable delay times. 2 separate relay outputs	Cosφ monitoring relay. 1- or 3-phase AC (measures its own power supply). Direct input or through external CT. Power ON delay adjustable
<b>Input specifications</b>			
Measuring range	50 / 60 Hz	50 / 60 Hz	cosφ : 0.1-0.99
<b>Output specifications</b>			
	1 x SPDT relay	2 x SPDT relay	1 x SPDT relay
Max. load AC1	8 A / 250 VAC	8 A / 250 VAC	8 A / 250 VAC
Max. load DC12	5 A / 24 VDC	5 A / 24 VDC	5 A / 24 VDC
Electrical life	>1 x 10 <sup>5</sup> operations	>1 x 10 <sup>5</sup> operations	>1 x 10 <sup>5</sup> operations
<b>General specifications</b>			
Power supply	24 - 240 VAC	24 - 48 VAC [B48] 115 - 230 VAC [B23]	208 - 240 VAC [M23] 380 - 415 VAC [P] [M48] 380 - 480 VAC [D] [M48]
Approvals / Marks	CE - UL - CSA	CE - UL - CSA	CE - UL - CSA
<b>References</b>			
	<b>DFB01C M24</b>	<b>DFC01D B48</b>	<b>DWA01C M23 5A</b>
	<b>PFB01C M24</b>	<b>DFC01D B23</b>	<b>PWA01C M23 5A</b>
			<b>DWA01C M48 5A</b>
			<b>PWA01C M48 5A</b>

# Monitoring relays

## Power and power factor relays

Types	DWB 01 PWB 01	DWB 02 PWB 02	DWB 03 PWB 03
			
Dimensions HxWxD (mm)	80 x 45 x 99.5 [D]	80 x 45 x 99.5 [D]	80 x 45 x 99.5 [D]
DIN RAIL housing	80 x 36 x 94 [P]	80 x 36 x 94 [P]	80 x 36 x 94 [P]
Plug-in housing	80 x 36 x 94 [P]	80 x 36 x 94 [P]	80 x 36 x 94 [P]
Function	Power factor monitoring relay. 1- or 3-phase (measures its own power supply) AC TRMS. Direct input or through external CT. 2 separately adjustable setpoints. Delay time adjustable. Power ON delay adjustable	Active power monitoring relay. 1- or 3-phase (measures its own power supply) AC TRMS. Direct input or through external CT. 2 separately adjustable setpoints. Delay time adjustable. Power ON delay adjustable	Active power monitoring relay. 1- or 3-phase AC TRMS power direction (measures its own power supply). Direct input or through external CT. 2 separately adjustable setpoints. Delay time adjustable. Power ON delay adjustable
<b>Input specifications</b>			
Measuring range	cosφ : 0.1 - 0.99	208 - 690 VAC 0.5 - 5 AAC 1 - 10 AAC 0.4 - 4 Vp	208 - 690 VAC 0.5 - 5 AAC 1 - 10 AAC 0.4 - 4 Vp
<b>Output specifications</b>			
Max. load AC1	1 x SPDT relays 8 A / 250 VAC	1 x SPDT relays 8 A / 250 VAC	1 x SPDT relays 8 A / 250 VAC
Max. load DC12	5 A / 24 VDC	5 A / 24 VDC	5 A / 24 VDC
Electrical life	>1 x 10 <sup>5</sup> operations	>1 x 10 <sup>5</sup> operations	>1 x 10 <sup>5</sup> operations
<b>General specifications</b>			
Power supply	208 - 240 VAC [M23] 380 - 415 VAC [P] [M48] 380 - 480 VAC [D] [M48] 600 - 690 VAC [M69]	208 - 240 VAC [M23] 380 - 415 VAC [P] [M48] 380 - 480 VAC [D] [M48] 600 - 690 VAC [M69]	208 - 240 VAC [M23] 380 - 415 VAC [P] [M48] 380 - 480 VAC [D] [M48] 600 - 690 VAC [M69]
Approvals / Marks	CE - UL - CSA	CE - UL - CSA	CE - UL - CSA
<b>References</b>			
	DWB01C M23 10A	DWB02C M23 10A	DWB03C M23 10A
	PWB01C M23 10A	PWB02C M23 10A	PWB03C M23 10A
	DWB01C M48 10A	DWB02C M48 10A	DWB03C M48 10A
	PWB01C M48 10A	PWB02C M48 10A	PWB03C M48 10A
	DWB01C M69 10A	DWB02C M69 10A	DWB03C M69 10A

# Monitoring relays, timers

	Temperature relays	Pump alternating relays	Timers, Delay on operate
<b>Types</b>	<b>DTA 01 PTA 01 DTA 02 PTA 02</b>	<b>DLA 71 DLA 73</b>	<b>DAA 01 PAA 01</b>
			
<b>Dimensions HxWxD (mm)</b>			
DIN RAIL housing	80 x 22.5 x 99.5 [D]	81 x 35.5 x 67.2 [Mini-D]	80 x 22.5 x 99.5 [D]
Plug-in housing	80 x 36 x 94 [P]		80 x 36 x 94 [P]
<b>Function</b>	Motor temperature monitoring relays. PTC insulated input. Automatic set-point. Short circuit detection. Latch, test and reset function (DTA02, PTA02)	Pump alternating relay. For 2 or 3 pumps. Differential or sequential mode. Automatic rotation of the pumps. Output relay managed by one independent input contact (DLA73)	Delay on operate (manual start)
<b>Input specifications</b>			
<b>Time range</b>			0.1 s - 1 s / 1 s - 10 s 6 s - 60 s / 60 s - 600 s 0.1 h - 1 h / 1 h - 10 h 10 h - 100 h
<b>Output specifications</b>			
	1 x SPDT relay 1 x SPST relay [DTA01]	2 x SPST relay [DLA71] [2P] 3 x SPST relay [DLA71] [3P] 3 x SPST relay [DLA73]	1 x SPDT relay [C] 2 x SPDT relays [D]
<b>Max. load AC1</b>	8 A / 250 VAC	5 A / 250 VAC	8 A / 250 VAC
<b>Max. load DC12</b>	5 A / 24 VDC	5 A / 24 VDC	5 A / 24 VDC
<b>Electrical life</b>	>1 x 10 <sup>5</sup> operations	>1 x 10 <sup>5</sup> operations	>1 x 10 <sup>5</sup> operations
<b>General specifications</b>			
<b>Power supply</b>	24 - 48 VAC/DC [D48] 115 VAC [115] 230 VAC [230]	24 / 48 VAC [B48] 115 / 230 VAC [B23]	24 VDC / 24 - 240 VAC [C] 24 - 240 VAC/DC [D]
<b>Approvals / Marks</b>	CE - UL - CSA	CE - UL - CSA	CE - UL - CSA
<b>References</b>			
	<b>DTA01C D48</b>	<b>DLA71D B48 2P</b>	<b>DAA01C M24</b>
	<b>PTA01C D48</b>	<b>DLA71T B48 3P</b>	<b>PAA01C M24</b>
	<b>DTA01C 115</b>	<b>DLA71D B23 2P</b>	<b>DAA01D M24</b>
	<b>PTA01C 115</b>	<b>DLA71T B23 3P</b>	<b>PAA01D M24</b>
	<b>DTA01C 230</b>	<b>DLA73T B23 2P</b>	
	<b>PTA01C 230</b>	<b>DLA73T B48 2P</b>	
	<b>DTA02C D48</b>		
	<b>PTA02C D48</b>		
	<b>DTA02C 115</b>		
	<b>PTA02C 115</b>		
	<b>DTA02C 230</b>		
	<b>PTA02C 230</b>		

# Timers

## Delay on operate

Types	DAA 51 DAA 71	FAA 01 FAA 08	HAA 08 HAA 14
-------	------------------	------------------	------------------



Dimensions HxWxD (mm)  
DIN RAIL housing

81 x 17.5 x 67.2 <sup>[Mini-D]</sup>  
81 x 35.5 x 67.2 <sup>[Mini-D]</sup>

48 x 48 x 83.4

28 x 21.5 x 64

Plug-in housing

Function

Delay on operate (automatic start)

Delay on operate.  
Symmetrical recycler.  
Interval.  
One shot

Delay on operate.  
Symmetrical recycler with  
ON or OFF first.  
Interval

## Input specifications

	DAA 51 DAA 71	FAA 01 FAA 08	HAA 08 HAA 14	
Time range	0.1 s - 1 s 1 s - 10 s 6 s - 60 s 60 s - 600 s 0.1 h - 1 h 1 h - 10 h 10 h - 100 h	Full scale 12 0.02 - 1.2 s 0.2 - 12 s 2 - 120 s 0.2 - 12 m 2 - 120 m 0.2 - 12 h 2 - 120 h	Full scale 30 0.05 - 3 s 0.5 - 30 s 5 - 300 s 0.5 - 30 m 5 - 300 m 0.5 - 30 h 5 - 300 h	0.1 s - 1 s 1 s - 10 s 6 s - 60 s 60 s - 600 s 0.1 h - 1 h 1 h - 10 h 10 h - 100 h

## Output specifications

	DAA 51 DAA 71	FAA 01 FAA 08	HAA 08 HAA 14
	1 x SPDT relay [C] 1 x DPDT relay [D]	1 x DPDT relay 11-pin [01] 8-pin [08]	1 x 4PDT relay [Q] 1 x DPDT relay [D] 14-pin [14] 8-pin [08]
Max. load AC1	5 A / 250 VAC	5 A / 250 VAC	5 A / 250 VAC
Max. load DC12	5 A / 24 VDC	5 A / 24 VDC	5 A / 24 VDC
Electrical life	>1 x 10 <sup>5</sup> operations	>1 x 10 <sup>5</sup> operations	>1 x 10 <sup>5</sup> operations



## General specifications

	DAA 51 DAA 71	FAA 01 FAA 08	HAA 08 HAA 14
Power supply	24 VDC / 24-240 VAC [CM24] 24-240 VAC / DC [DM24] 12-240 VAC / DC [DW24]	12-240 VAC / DC	24-240 VAC / DC
Approvals / Marks	CE - UL - CSA - RINA - CCC [DAA51_B001]	CE - UL - CSA	CE - UL - CSA



## References

DAA51C M24	FAA01D W24	HAA14Q M24
DAA71D M24	FAA08D W24	HAA08D M24
DAA71D W24		

# Timers





	Delay on release		True delay on release
Types	DBA 02 PBA 02	DBA 52	D/PBB 01 D/PBB 02
			
Dimensions HxWxD (mm)			
DIN RAIL housing	80 x 22.5 x 99.5 [D]	81 x 17.5 x 67.2 [Mini-D]	80 x 22.5 x 99.5 [D]
Plug-in housing	80 x 36 x 94 [P]		80 x 36 x 94 [P]
Function	Delay on release	Delay on release	True delay on release
<b>Input specifications</b>			
Time range	0.1 s - 1 s / 1 s - 10 s 6 s - 60 s / 60 s - 600 s 0.1 h - 1 h / 1 h - 10 h 10 h - 100 h	0.1 s - 1 s / 1 s - 10 s 6 s - 60 s / 60 s - 600 s 0.1 h - 1 h / 1 h - 10 h 10 h - 100 h	D/PBB01: 0.1 s - 1 s / 1 s - 10 s 6 s - 60 s / 60 s - 600 s D/PBB02: 60 s - 600 s / 0.1 h - 1 h 1 h - 10 h
<b>Output specifications</b>			
	1 x SPDT relay	1 x SPDT relay	1 x SPDT relay [C] 1 x DPDT relay [D]
Max. load AC1	8 A / 250 VAC	5 A / 250 VAC	8 A / 250 VAC
Max. load DC12	5 A / 24 VDC	5 A / 24 VDC	5 A / 24 VDC
Electrical life	>1 x 10 <sup>5</sup> operations	>1 x 10 <sup>5</sup> operations	>1 x 10 <sup>5</sup> operations
<b>General specifications</b>			
Power supply	24 VDC / 24-240 VAC	24 VDC / 24-240 VAC	24-240 VAC / DC [M24] 12-24 VDC [724]
Approvals / Marks	CE - UL - CSA	CE - UL - CSA	CE - UL - CSA
<b>References</b>			
	<b>DBA02C M24</b>	<b>DBA52C M24</b>	<b>DBB01C M24</b>
	<b>PBA02C M24</b>		<b>PBB01C M24</b>
			<b>DBB01D M24</b>
			<b>PBB01D M24</b>
			<b>DBB01C 724</b>
			<b>PBB01C 724</b>
			<b>DBB01D 724</b>
			<b>PBB01D 724</b>
			<b>DBB02C M24</b>
			<b>PBB02C M24</b>
			<b>DBB02D M24</b>
			<b>PBB02D M24</b>

# Timers

	True delay on release	Recycler	
Types	DBB 51	DCB 01 PCB 01	DCB 51
			
Dimensions HxWxD (mm) DIN RAIL housing Plug-in housing	81 x 17.5 x 67.2 [Mini-D]	80 x 22.5 x 99.5 [D] 80 x 36 x 94 [P]	81 x 17.5 x 67.2 [Mini-D]
Function	True delay on release	Asymmetrical recycler with ON and OFF time first. One shot. Two state delay on operate	Asymmetrical recycler with ON or OFF first
<b>Input specifications</b>			
Time range	1 s - 10 s [10S] 6 s - 60 s [1M] 60 s - 600 s [10M]	0.1 - 1 s / 1 - 10 s 6 - 60 s / 60 s - 600 s 0.1 h 1 h / 1 h - 10 h 10 h - 100 h	0.1 - 1 s / 1 - 10 s 6 - 60 s / 60 s - 600 s 0.1 h 1 h / 1 h - 10 h 10 h - 100 h
<b>Output specifications</b>			
	1 x SPDT relay	1 x SPDT relay [C] 2 x SPDT relays [D]	1 x SPDT relay
Max. load AC1	5 A / 250 VAC	8 A / 250 VAC	5 A / 250 VAC
Max. load DC12	5 A / 24 VDC	5 A / 24 VDC	5 A / 24 VDC
Electrical life	>1 x 10 <sup>5</sup> operations	>1 x 10 <sup>5</sup> operations	>1 x 10 <sup>5</sup> operations
<b>General specifications</b>			
Power supply	24 VDC / 24-240 VAC	24 VDC / 24-240 VAC [C] 24-240 VAC / DC [D]	24 VDC / 24-240 VAC
Approvals / Marks	CE - UL - CSA - RINA	CE - UL - CSA	CE - UL - CSA
<b>References</b>			
	DBB51C M24 10S	DCB01C M24	DCB51C M24
	DBB51C M24 1M	PCB01C M24	
	DBB51C M24 10M	DCB01D M24	
		PCB01D M24	

# Timers

## Multifunction

Types	DMB 01 PMB 01	DMB 51 PMB 71	FMB 01	DMC 01 PMC 01
				
Dimensions HxWxD (mm) DIN RAIL housing	80 x 22.5 x 99.5 [D]	81 x 17.5 x 67.2 [Mini-D] 81 x 35.5 x 67.2 [Mini-D]	48 x 48 x 83.4	80 x 22.5 x 99.5 [D] 80 x 45 x 99.5 [D] 80 x 36 x 94 [P]
Plug-in housing	80 x 36 x 94 [P]			

Function	DMB 01 PMB 01	DMB 51 PMB 71	FMB 01	DMC 01 PMC 01
	<b>Multifunction:</b> <ul style="list-style-type: none"> <li>• Delay on operate - manual start</li> <li>• Delay on release</li> <li>• Interval - manual start</li> <li>• Symmetrical recycler</li> <li>• Double interval</li> <li>• Interval on trigger open</li> </ul>	<b>Multifunction:</b> <ul style="list-style-type: none"> <li>• Delay on operate - manual start</li> <li>• Delay on release</li> <li>• Interval - manual start</li> <li>• Symmetrical recycler</li> <li>• Double interval</li> <li>• Interval on trigger open</li> </ul>	<b>Multifunction:</b> (Trigger, Gate and Reset inputs) <ul style="list-style-type: none"> <li>• Delay on operate - manual start</li> <li>• Delay on release</li> <li>• Interval - manual start</li> <li>• Symmetrical recycler</li> <li>• Double interval</li> <li>• Interval on trigger open</li> </ul>	<b>Multifunction:</b> <ul style="list-style-type: none"> <li>• Delay on operate - manual start</li> <li>• Delay on operate - automatic and manual start</li> <li>• Delay on release</li> <li>• Interval - manual start</li> <li>• Interval - automatic and manual start</li> <li>• Interval - manual start with no time reset</li> <li>• Interval - automatic and manual start with no time reset</li> </ul>

## Input specifications

Time range	DMB 01 PMB 01	DMB 51 PMB 71	FMB 01	DMC 01 PMC 01
	0.1 s - 1 s / 1 s - 10 s 6 s - 60 s / 60 s - 600 s 0.1 h - 1 h / 1 h - 10 h 10 h - 100 h	0.1 s - 1 s / 1 s - 10 s 6 s - 60 s / 60 s - 600 s 0.1 h - 1 h / 1 h - 10 h 10 h - 100 h	Full scale: 12 0.02 - 1.2 s / 0.2 - 12 s 2 - 120 s / 0.2 - 12 m 2 - 120 m / 0.2 - 12 h 2 - 120 h Full scale: 30 0.05 - 3 s / 0.5 - 30 s 5 - 300 s / 0.5 - 30 m 5 - 300 m / 0.5 - 30 h 5 - 300 h	0.1 s - 1 s / 1 s - 10 s 6 s - 60 s / 60 s - 600 s 0.1 h - 1 h / 1 h - 10 h 10 h - 100 h

## Output specifications

	DMB 01 PMB 01	DMB 51 PMB 71	FMB 01	DMC 01 PMC 01
	1 x SPDT relay [C] 1 x DPDT relay [D]	1 x SPDT relay [C] 1 x DPDT relay [D]	1 x DPDT relay	1 x SPDT relay [C] 2 x SPDT relay [D]
Max. load AC1	8 A / 250 VAC	5 A / 250 VAC	5 A / 250 VAC	8 A / 250 VAC
Max. load DC12	5 A / 24 VDC	5 A / 24 VDC	5 A / 24 VDC	5 A / 24 VDC
Electrical life	>1 x 10 <sup>5</sup> operations	>1 x 10 <sup>5</sup> operations	>1 x 10 <sup>5</sup> operations	>1 x 10 <sup>5</sup> operations

## General specifications



Power supply	DMB 01 PMB 01	DMB 51 PMB 71	FMB 01	DMC 01 PMC 01
	24 VDC & 24-240 VAC [C] 24-240 VAC/DC [D]	24 VDC & 24-240 VAC [M24] 12-240 VAC/DC [W24]	12-240 VAC/DC	24 VDC [724] 24 / 48 VAC [B48] 115 / 230 VAC [B23] 24 VAC [024] 115 VAC [115] 230 VAC [230]
Approvals / Marks	CE - UL - CSA - RINA	CE - UL - CSA - RINA - CCC [DMB51_B006]	CE - UL - CSA	CE - UL - CSA

## References

	DMB 01 PMB 01	DMB 51 PMB 71	FMB 01	DMC 01 PMC 01
	DMB01C M24 PMB01C M24	DMB51C M24 DMB51C W24	FMB01D W24	DMC01C xxx PMC01C yyy
	DMB01D M24 PMB01D M24	DMB71D M24 DMB71D W24		DMC01D xxx PMC01D yyy





xxx= 724, B23, B48  
yyy= 724, 024, 115, 230





# Timers

	Mini-E timers	Star delta	
Types	EAS EBS ECS	DAC 01 PAC 01	DAC 51
			
Dimensions HxWxD (mm) DIN RAIL housing	56 x 22.5 x 49 [Mini-E] 56 x 22.5 x 44 [Mini-E] [F]	80 x 22.5 x 99.5 [D]	81 x 17.5 x 67.2 [Mini-D]
Plug-in housing		80 x 36 x 94 [P]	
Function	EAS - Delay on operate (automatic start). EBS - Interval (automatic start). ECS - Symmetrical recycler (ON/OFF automatic start) thyristor output. Screw or fast-ON connection. DIN-rail or chassis mounting	Star delta	Star delta
<b>Input specifications</b>			
Time range	[10S]: 0.5 s - 10 s [1M]: 0.1 m - 1 m [10M]: 1 m - 10 m	0.1 s - 1 s / 1 s - 10 s 6 s - 60 s / 60 s - 600 s	0.1 s - 1 s / 1 s - 10 s 6 s - 60 s / 60 s - 600 s
Star to delta relay (neutral centre position)		50 - 130 ms between star to delta position	50 - 130 ms between star to delta position
<b>Output specifications</b>			
	Static output 500 mA, 700 mA [F]	1 x SPDT relay (with neutral centre position)	1 x SPDT relay (with neutral centre position)
Max. load AC1		8 A / 250 VAC	5 A / 250 VAC
Max. load DC12		5 A / 24 VDC	5 A / 24 VDC
Electrical life		>1 x 10 <sup>5</sup> operations	>1 x 10 <sup>5</sup> operations
<b>General specifications</b>			
Power supply	24-230 VAC / DC [EAS] 24-230 VAC [EBS], [ECS]	24-240 VAC / DC [M24] 380-415 VAC [M40]	24-240 VAC / DC
Approvals / Marks	CE - UL - CSA	CE - UL - CSA	CE - UL - CSA
<b>References</b>			
	EAS S M23 ...	DAC01C M24	DAC51C M24
	EAS S M23 ... F	PAC01C M24	
	EBS S M23 ...	DAC01C M40	
	EBS S M23 ... F	PAC01C M40	
	ECS S M23 A ...		
	ECS S M23 B ...		
	ECS S M23 A ... F		
	ECS S M23 B ... F		
	... = insert code for Time Range		



# Counters

Electromechanical counters				
Types	EMCT46/EMCT47	E2CT4	E1CT4	ECH4
				
Version	Micro	Mini	Standard	Combination time and energy meter
Dimensions HxWxD (mm)	13.8 x 25x 35.2 20 x 30 x 36.2	24 x 48 x 53.8	24 x 48 x 49	48 x 48 x 38
Technical data				
Number of digit	6/7	5	6	7/8
Reset	no	yes	no	no
Digit height, visible (mm)	4 x 1.7 / 4 x 1.2	4 x 1.7	4 x 1.7	4 x 1.7
Panel cut-out (mm)	e.g. 27x 14	45 x 22 / 31 x 20	45 x 22 / 31 x 20	46 x 46 X Ø50.5
Mounting type	Panel / PCB	Panel / base mount / PCB	Panel / base mount / PCB	Panel / DIN-rail
Degree of protection	up to IP 65	IP 41	IP 41	IP 52 front side
Pulse voltage min. / max.	1.5 to 24 VDC	24 to 230 VAC 12 to 24 VDC	24 to 230 VAC 12 to 24 VDC	0 to 260 VAC 0 to 260 VDC
Max. count frequency	10 Hz	10 Hz	10 Hz	10 Hz
Min. power consumption	70 mW	130 mW	50 mW	1 W / 3 V
References				
	EMCT46xxxxxx EMCT47xxxxxx	E2CT4xxxxxx	E1CT4xxxxxx	ECH4

Electronic counters				
Types	FKA	DCT86	DMF861	DMF862
				
Version	LCD-Panel mount	LED-Panel mount	LED-Panel mount	LED-Panel mount
Dimensions HxWxD (mm)	DIN 48 x 24	DIN 48 x 24	DIN 48 x 24	DIN 48 x 24
Function				
Totaliser	yes			
Pulse counter		yes	yes	2 pulse counters, Pulse counter and timer, Pulse and frequency meter or 2 timers
Position display for encoders			yes	
Frequency meter/Tachometer			yes	
Timer			yes	
Technical data				
Number of digit	8	6	6	6
Reset	manual / electric	manual / electric	manual / electric	manual / electric
Digit height, visible (mm)	8	8	8	8
Panel cut-out(mm)	45 x 22	45 x 22	45 x 22	45 x 22
Degree of protection	IP 65 front side	IP 65 front side	IP 65 front side	IP 65 front side
Min. power consumption (W/VA)	12000	60000	60000	60000
Power supply	Lithium battery	10 to 30 VDC	10 to 30 VDC	10 to 30 VDC
Count inputs	NPN/PNP 10 to 260 VAC/DC	NPN/PNP	NPN/PNP	NPN/PNP
References				
	FKAxxxxxx	NI-DCT86xxxxxx	NI-DMF861xxxxxx	NI-DMF862xxxxxx

# Counters

## Digital multifunction

### Types

**DMF1461**

**DMF1462**



Version	LED - Panel mount	LED - Panel mount
Dimensions HxWxD (mm)	DIN 96 x 48	DIN 96 x 48

### Function

Pulse counter	Yes	2 pulse counters, Pulse counter and timer, Pulse and frequency meter or 2 timers
Position display for encoders	Yes	
Frequency meter / Tachometer	Yes	
Timer	Yes	

### Technical data

Number of digit	6	6
Reset	manual / electric	manual / electric
Preset	-	-
Digit height, visible (mm)	14	14
Panel cut-out (mm)	92 x 45	92 x 45
Degree of protection	IP 65 front side	IP 65 front side
Max. count frequency (Hz)	60000	60000
Supply voltage	90...260 VAC / 10...30 VDC	90...260 VAC / 10...30 VDC
Count inputs	Schmitt-Trigger	Schmitt-Trigger

### References

**DMF1461xx0**

**DMF1462xx0**

## Hour meter electromechanical

### Types

**E1HM4**

**E2HM4**

**E2HM35**

**E1HM35**



Version	Panel mount	Panel mount	Panel mount	DIN rail
Dimensions HxWxD (mm)	DIN 48 x 24 - DIN 25 x 53	DIN 48 x 48	Ø71.1 x 37.3	90 x 36 x 66

### Technical data

Number of digit	7/8	7/8	6	7
Time range	0.01~99999.99h	0.01~99999.99h	0.01~99999.99h	0.01~99999.99h
Digit height, visible (mm)	4	4	3.5	3.5
Panel cut-out(mm)	45 x 22 / 50 x 25	46 x 46	Ø56.7	-
Degree of protection	IP 65 front side	IP 65 front side	IP 65 front side	IP 65 front side
Min. power consumption (W/VA)	0.5 / 1.2	0.5 / 1.2	0.8 / 0.4	1 / 2.5
Voltage range	20...264 VAC 10...130 VDC / 24 VDC	20...264 VAC - 100...130 VAC 10...30 VDC	115...230 VAC 10...80 VDC	230 VAC 10...27 VDC

### References



**E1HM4xxxxxx**

**E2HM4xxxxxx**

**E2HM35xxxxxx**





**E1HM35xxxxxx**

# Counters

	Hour meter electronic LCD		Electronic multifunction counters
Types	FSA01	FSA02	DMF61 / DMF62
			
Version	LCD panel mount	LCD panel mount	LCD panel mount
Dimensions HxWxD (mm)	DIN 24 x 48	DIN 24 x 48	DIN 48 x 48
<b>Technical data</b>			
Number of digit	7	8	2 x 6
Time range	0.01 h; h.min	0.01 h; h.min	
Max. Count frequency (Hz)			s. min. h or hh.mm.ss
Preset			61 : 1 / 62 : 2
Reset	manual	manual	electronic
Digit height, visible (mm)	8	8	
Panel cut-out (mm)	45 x 22	45 x 22	45 x 45
Mounting type	Panel mount	Panel mount	Panel mount
Degree of protection	IP 65 front side	IP 65 front side	IP 65 front side
Power supply	Lithium battery (>8years)	Lithium battery (>8years)	90 to 260 VAC 11 to 30 VDC
Output			Relay or Optocoupler
Input			2 count inputs, gate, reset, lock, MPI, 4 optional inputs
<b>References</b>			
	FSA01xxxxx	FSA02xxxxx	DMF6101xxxx0 DMF6201xxxx0

## Surge arresters





### Surge arresters for AC lines

Types	DSF A/P	DSB A 52	DSB P 53	DSB P 54
				
Dimensions HxWxD (mm)	90 x 18 x 72 [51] 90 x 36 x 72 [52] 90 x 54 x 72 [53] 90 x 72 x 72 [54]	90 x 36 x 72	90 x 54 x 72	90 x 72 x 72
Description	No backup fuse Surge arresters for AC lines single or 3phase network types TN-S; TT; IT; TN-C Removable cartridges No leakage current	Surge arresters for AC lines single phase. Removable cartridges	Surge arresters for AC lines three phase Removable cartridges	Surge arresters for AC lines three phase Removable cartridges
<b>Output specifications</b>				
Out (Alarm)	1 x SPDT relay	1 x SPDT relay (option)	1 x SPDT relay (option)	1 x SPDT relay (option)
<b>General specifications</b>				
SPD class	Class II	Class II	Class II	Class II
Max. continuous voltage Uc	150 VAC 300 VAC 385 VAC 460 VAC 550 VAC 750 VAC	275 VAC / 350 VDC 385 VAC / 500 VDC	275 VAC / 350 VDC 385 VAC / 500 VDC 440 VAC / 580 VDC	275 VAC / 350 VDC 385 VAC / 500 VDC 440 VAC / 580 VDC
I <sub>n</sub> (8/20)	20 kA 10 kA [DSF5xCA750]	20 kA / pole	20 kA / pole	20 kA / pole
I <sub>max</sub> (8/20)	50 kA 25 kA [DSF5xCA750]	40 kA / pole	40 kA / pole	40 kA / pole
I <sub>imp</sub> (10/350)	-	-	-	-
Response time	< 25 ns	< 25 ms with GDT 25 ms (L-N), 100 ms (N-PE) without GDT	< 25 ms	< 25 ms with GDT 25 ms (L-N), 100 ms (N-PE) without GDT
Back-up fuse	Not required up to 200 kArms	125 A gL	125 A gL	125 A gL
Mounting	DIN rail	DIN rail	DIN rail	DIN rail
Temperature range	-40°C to +80°C -40°F to +176°F	-40°C to +80°C -40°F to +176°F	-40°C to +80°C -40°F to +176°F	-40°C to +80°C -40°F to +176°F
Approvals / Marks	CE, UR (UL 1449 3rd ED.), CSA	CE: IEC61643	CE: IEC61643	CE: IEC61643

### References

For ordering key details, please refer to [www.productselection.net](http://www.productselection.net)

# Surge arresters

	Surge arresters for PV systems		Surge arresters for communication lines	
Types	DSF D	DSC	DSB S	DSB DP
				
Dimensions HxWxD (mm)	90 x 36 x 72 [52] 90 x 54 x 72 [53]	90 x 18 x 72 [51] 90 x 36 x 72 [52] 90 x 54 x 72 [53] 90 x 72 x 72 [54]	90 x 12 x 71.5	90 x 12 x 71.5

Description	No backup fuse, 2-pole [52] or 3-pole [53] surge arresters for P.V. installations No leakage	Class I and II Surge arresters for DC systems	Surge arresters for RS485 communication lines Removable cartridges	Surge arresters for Dupline® and Smarthouse® communication lines Removable cartridges
-------------	---	---	---	--

## Output specifications

Out (Alarm)	1 x SPDT relay	1 x SPDT relay	None	None
-------------	----------------	----------------	------	------

## General specifications



SPD class	Class II	Class I, II	Class C1/C2/C3 (IEC 60643-21)	Class C1/C2/C3 (IEC 60643-21)
Max. continuous voltage $U_c$	600 VDC [600, 1200] 1000 VDC [1000] 1200 VDC [1200]	1000 V	6 VDC	18 VDC
$I_n$ (8/20)	20 kA [600, 1200] 12.5 kA [1000]	20 kA / pole	10 kA / pole	10 kA / pole
$I_{max}$ (8/20)	40 kA [600, 1200] 25 kA [1000]	40 kA / pole	20 kA / pole	20 kA / pole
$I_{imp}$ (10/350)	-	12.5 kA / pole	-	-
Response time	< 25 ns	<25 ns	<1 ns	<1 ns
Back-up fuse	Not required up to 200 kArms	N.A.		
Mounitng	DIN rail	DIN rail	DIN rail	DIN rail
Temperature range	-40°C to +80°C -40°F to +176°F	-40°C to +80°C -40°F to +176°F	-40°C to +80°C -40°F to +176°F	-40°C to +80°C -40°F to +176°F
Approvals / Marks	CE, UR (UL 1449 3 <sup>rd</sup> ED.), UTE C 61-740-51, CSA	CE: IEC616431; UTE C61-740-51	CE: IEC 60643-21	CE: IEC 60643-21

## References

DSF52XD600PV	DSC54CD1000PV	DSB51XXP	DSB51XXDP
DSF52CD600PV	DSC54XD1000PV		
DSF52XD1000PV			
DSF52CD1000PV			
DSF53XD1200PV			
DSF53CD1200PV			

# Digital panel meters

## Ammeters, voltmeters and frequency meters

Types	DI3 DIN	DI3 72	LDI 3
			
Dimensions HxWxD (mm)	89 x 52.5 x 58.5	72 x 72 x 75.5	48 x 96 x 83
Function	3-digit meter. 1-phase AC, DC. Voltmeter, ammeter frequency meter	Microprocessor based indicator. AC / DC Ammeter, Voltmeter. Freq. meter 3-digit display red LED. Height: 14.2 mm	Microprocessor based indicator. AC / DC Ammeter, Voltmeter. Freq. meter 3-digit display

### Input specifications

Range code	1 A / 100 VAC [AV1] 5 A / 500 VAC [AV5] 1 A / 60 mV / 100 V / 500 VDC [AV6] 1 Hz to 1000 Hz [F1K]	[AV1]: 1 AAC / 100 VAC [AV5]: 5 AAC / 500 VAC [AV6]: 1 ADC / 60 mV / 100 V / 500 VDC	[AV1]: 1 AAC / 100 VAC [AV5]: 5 AAC / 500 VAC [AV6]: 1 ADC / 60 mV / 100 V / 500 VDC [F1K]: 1 to 1000Hz
Accuracy	0.5% FS (0.1% FS frequency meter)	±0.5% FS	±0.5% FS (±0.3% FS frequency meter)
Indication	Max.	999 [AV1 / AV5]	999 [AV1 / AV5], 000 [AV1 / AV5]
	Min.	000 [AV1 / AV5] -99 [AV6]	000 [AV1 / AV5] -99 [AV6]
Range selection / decimal point pos.	Selectable by DIP-switch	Selectable by DIP-switch	Selectable by DIP-switch
Display refresh time	1 time/s	1 time/s	1 time/s



### General specifications

Power supply	24 VAC [A] 48 VAC [B] 115 VAC [C] 230 VAC [D]	24 VAC [A], 48 VAC [B], 115 VAC [C], 230 VAC [D]	24 VAC [A], 48 VAC [B], 115 VAC [C], 230 VAC [D]
Option		IP65[EX]	IP65[IX], tropicalization [XT]
Safety Standards	EN 61010-1, IEC 61010-1, VDE0411	EN 61010-1, IEC 61010-1, VDE0411	EN 61010-1, IEC 61010-1, VDE0411
Approvals / Marks	CE - CSA	CE - CSA	CE - c CSA us

### References

For ordering key details, please refer to [www.productselection.net](http://www.productselection.net)

# Digital panel meters

	Ammeters and voltmeters		Thermometer and ohmmeter
Types	LDI 35 AV0	LDI 35 AV2	LDI 35 CF
			
Dimensions HxWxD (mm)	48 x 96 x 83	48 x 96 x 83	48 x 96 x 83
Function	Microprocessor based indicator/controller, AC / DC ammeter, voltmeter, 3½-digit or 3-digit + dummy zero display	Microprocessor based indicator/controller, AC / DC ammeter, voltmeter, 3½-digit or 3-digit + dummy zero display	Microprocessor based indicator/controller, Temperature resistance Measuram. in C° or F° 3½-digit or 3-digit + dummy zero display
<b>Input specifications</b>			
Range code	Current: 2 mA DC, 20 mA DC Voltage: 200 mV DC, 20 VDC, 200 VDC [AV0]	Current: 2 AAC/DC, 5 AAC/DC Voltage: 200 VAC/DC, 500 VAC/DC [AV2]	Pt100, Ni100 [CFX]; Pt1000 [CFP]; TC-J-LK-S-T [CFX/CFP]; 200.0Ω [CFX]; 2000Ω [CFP]
Accuracy	±0.3% FS	DC: ±0.3% FS, AC: ±0.5% FS	TC, PT100/1000, resistance ±0.3% FS Ni 100 ±0.5% FS
Indication	Max.	3½-dgt: 1999, 3+0-dgt: 9990	Depending on range and type of the temperature probe
	Min.	3½-dgt: -1999, 3+0-dgt: -1990	
Resistance			0 to 200 Ω (2000 Ω)
Range election / decimal point pos.	Programmable	Programmable	Programmable
Display refresh time	4 times/s	4 times/s	4 times/s
<b>Functions</b>			
	Password protection. Scaling factor. Diagnostics. Digital filter programm. Max. data hold.	Password protection. Scaling factor. Diagnostics. Digital filter programm. Max. data hold.	Password protection. Scaling factor. Diagnostics. Digital filter programm. Max. data hold.
<b>Output specifications</b>			
Setpoints	1 optional alarm [1] 5 A / 250 VAC / DC. Excit. output 40 mA / 15 VDC [AX]	1 optional alarm [1] 5 A / 250 VAC / DC. Excit. output 40 mA / 15 VDC [AX]	1 optional alarm [1] 5 A / 250 VAC / DC. Excit. output 40 mA / 15 VDC [AX]
<b>General specifications</b>			
Power supply	120 [E], 230 [D], 240 [F], 24 [A], 48 [B], 115 [C] VAC, 9 - 32 [3] VDC, 40 - 150 [6] VDC	120 [E], 230 [D], 240 [F], 24 [A], 48 [B], 115 [C] VAC, 9 - 32 [3] VDC, 40-150 [6] VDC	120 [E], 230 [D], 240 [F], 24 [A], 48 [B], 115 [C] VAC, 9 - 32 [3] VDC, 40-150 [6] VDC
Option	IP65[IX], excit. out [AX], tropicalization [XT]	IP65[IX], excit. out [AX], tropicalization [XT]	IP65[IX], excit. out [AX], tropicalization [XT]
Safety Standards	EN 61010-1, IEC 61010-1, VDE0411	EN 61010-1, IEC 61010-1, VDE0411	EN 61010-1, IEC 61010-1, VDE0411
Approvals / Marks	CE - c CSA us	CE - c CSA us	CE - c CSA us
<b>References</b>			
For ordering key details, please refer to <a href="http://www.productselection.net">www.productselection.net</a>			

# Digital panel meters

## Ammeters and voltmeters

### Types

### LDM 30

### LDM 35 H

### LDM 40



Dimensions HxWxD (mm)                      48 x 96 x 83                                      48 x 96 x 83                                      48 x 96 x 83

Function    3-digit + dummy 0  $\mu$ P-based indicator, red LED display                                      3 1/2-digit  $\mu$ P-based indicator and controller, 3 1/2-DGT or 3-DGT + dummy 0 red LED display                                      4-digit  $\mu$ P-based indicator and controller

### Input specifications

Range code    1A / 100 VAC [AV1]; 5A / 500 VAC [AV5]                                      (0.2-2-20 mA, 0.2-2-20 V) [LSE]; (0.2- 2-5 A, 20-200-500 V) [HSX]; DC and AC TRMS                                      (0.2-2-20 mA, 0.2-2-20 V) [LSE]; (0.2- 2-5 A, 20-200-500 V) [HSX]; DC and AC TRMS

Accuracy     $\pm 0.5\%FS, \pm 1DGT$                                       DC:  $\pm(0.3\%RDG + 3DGT)$   
AC:  $\pm(0.5\%RDG + 3DGT)$                                       DC:  $\pm(0.1\%RDG + 2DGT)$   
AC:  $\pm(0.3\%RDG + 2DGT)$

Indication    Max.    9990    9999

Min.    000    0 (AC) -9999 (DC)  
4-digit LED red

Range selection / decimal point pos.                                      Selectable by dipswitch                                      Programmable                                      Programmable

Display refresh time                                      2 times/s                                      5 times/s                                      5 times/s

### Functions

Signal / display scaling, Digital filter. Peak and valley

Signal / display scaling, Digital filter. Peak and valley

### Output specifications

Up to 2 Alarm relay, [1-2]

Up to 2 Alarm relay, [1-2],  
Analogue 0 to 20 mA,  
0 to 10 V [AV],  
RS485

### General specifications

Power supply    24 / 48 VAC [B], 115 / 230 VAC [D]                                      90 to 260 VAC / DC [H], 18 to 60 VAC / DC [L]                                      90 to 260 VAC / DC [H], 18 to 60 VAC / DC [L]

Option    Tropicalization [XT], IP 65 [IX]                                      Tropicalization [TX]                                      Tropicalization [T]

Safety Standards    EN61010-1 IEC61010-1                                      EN61010-1 IEC61010-1                                      EN61010-1 IEC61010-1

Approvals / Marks    CE - c UR us - c CSA us                                      CE - c UR us - c CSA us                                      CE - c UR us - c CSA us

### References

For ordering key details, please refer to [www.productselection.net](http://www.productselection.net)



# Digital panel meters

## Modular meter and conditioner

Types	UDM 35	UDM40/USC	UDM 60
			

Dimensions HxWxD (mm)	48 x 96 x 105	44 x 113 x 107 (USC) 48 x 96 x 105 (UDM40)	48 x 96 x 105
Function	MODULAR Microprocessor-based indicator / controller AC/DC Ammeter / Voltmeter / resistance / temperature measurement	MODULAR Microprocessor-based indicator / controller AC/DC Ammeter / Voltmeter / resistance / temperature measurement	MODULAR 6-DGT $\mu$ P-based controller

### Input specifications

Range code	0.2-2-20 mA DC/AC 0.2-2-20 VDC/AC [LSX] + AUX 13 VDC [LSE] or 25 VDC [LSF]; 0.2-2-5 A DC/AC; 20-200-500 V DC/AC [HSX]; TC: J-K-S-T-E, Pt100-250-500- 1000 [TRX]; 0.02-0.2-2-20 k $\Omega$ [TRX] 0.001 Hz to 50 Hz for DC signal [TF1] 0.001 Hz to 50 Hz for AC signal [TF2]	0.2-2-20 mA DC/AC 0.2-2-20 VDC/AC [LSX] + AUX 13 VDC [LSE] or 25 VDC [LSF]; 0.2-2-5 A DC/AC; 20-200-500 VDC/AC [HSX]; TC: J-K-S-T-E, Pt100-250-500- 1000 [TRX]; 0.02-0.2-2-20 k $\Omega$ [TRX] 0.001 Hz to 50 Hz for DC signal [TF1] 0.001 Hz to 50 Hz for AC signal [TF2]	Speed, frequency, rate, period, totalizer 0.001 Hz to 50 Hz for DC signal [TF1] 0.001 Hz to 50 Hz for AC signal [TF2]
Accuracy	0.1% RDG	0.1% RDG	$\pm$ (0.001%RDG + 3DGT)
Indication	Max.	1999	9 999 999
	Min.	0 (AC) -1999 (DC), 3 1/2-digit LED red	0 (AC) -9999 (DC), 4-digit LED. Colours: red, green, orange
Range election / decimal	Programmable	Programmable	Programmable
Display refresh time	5 times/s	5 times/s	

### Functions

	Password protection. Scaling factor. Min Max data storage. Programmable digital filter. Range selection. Programmable via PC	Password protection. Scaling factor. Min Max data storage. 16 linearization points. Programmable digital filter. Range selection. Programmable via PC	Signal/display scaling. Analogue output scaling. Digital filter. Peak and valley. Linearization. Combination of the inputs according to predefined functions. Pulse metering and totalizing
--	---	---	---

### Output specifications

Setpoints	Analogue 0 to 20 mA, 0 to 10 V [AV] Serial RS485 [SX], Serial RS232 [SY], Single relay output [R1], Dual relay output [R2], Dual relay + dual open coll. output [R4], Four relay output [R5]	Analogue 0 to 20 mA, 0 to 10 V [AV] Serial RS485 [SX], Serial RS232 [SY], Single relay output [R1], Dual relay output [R2], Dual relay + dual open coll. output [R4], Four relay output [R5]	Analogue 0 to 20 mA, 0 to 10 V [AV] Serial RS485 [SX], Serial RS232 [SY], Single relay output [R1], Dual relay output [R2], Dual relay + dual open coll. output [R4], Four relay output [R5]
-----------	---	---	---





### General specifications

Power supply	90 to 260 AC/ DC [H], 18 to 60 VAC/DC [L] 10 to 28 VDC [3]	90 to 260 AC/DC [H], 18 to 60 VAC/DC [L] 10 to 28 VDC [3]	90 to 260 AC/DC [H], 18 to 60 VAC/DC [L] 10 to 28 VDC [3]
Option	Tropicalization [TX]	Tropicalization [TX]	Tropicalization [TX]
Safety Standards	EN 61010-1, IEC 61010-1	EN 61010-1, IEC 61010-1	EN 61010-1, IEC 61010-1
Approvals / Marks	CE - c UR us - c CSA us	CE - c UR us - c CSA us	CE - c UR us - c CSA us

### References





For ordering key details, please refer to [www.productselection.net](http://www.productselection.net)

# Converters and gateway



	Serial converter		Ethernet gateway	M-bus converter
Types	SIU-PC2	SIU-PC3	SIU-TCP2	VMU-B
				
Dimensions HxWxD (mm)	Front: 100 x 67	Front: 60 x 37.5	Front: 78 x 65	Front: 90 x 17.5
Function	RS422 / RS485 to RS232 converter	RS422 / RS485 to USB converter	Ethernet to RS232 / 485 Gateway	Modbus to M-bus converter
<b>Port 1</b>				
Port connections	RS232 9-pole, female	USB type A	Ethernet, 10 / 100 Mbps RJ45	RS485
Baud rate	Max 230400 Baud	Max 961.6 kBaud	Max 230400 Baud	
<b>Port 2</b>				
Port connections	RS422, RS485 2-wire and 4-wire communication	RS232, RS485 2-wire communication	RS232, RS485 2-wire and 4-wire communication	M-bus
<b>General specifications</b>				
Power supply	12 to 30 VDC Suggested adapter: SPD12-10T (120 to 240 VAC/DC)	Self supplied by USB port	9 to 30 VDC AD5V1A: AC / DC power supply adapter (on request)	18 to 260 VAC/DC
Approvals / Marks	CE - FCC	CE - FCC	CE	CE
<b>References</b>				
	<b>SIU PC2</b>	<b>SIU PC3</b>	<b>SIU TCP2</b>	<b>VMUBM1US1B1X01</b>
	<b>SIU PC2I (2kV insulated)</b>			

# Safety modules

## Emergency stop and safety gates





Types	NES02D	NES13D	NDS12B	NA13CT
				
Dimensions HxWxD (mm)	99 x 22.5 x 114	99 x 22.5 x 114	99 x 22.5 x 114	99 x 22.5 x 114
Safety category	Up to category 4 (EN ISO 13849-1:2008)	Up to category 4 (EN ISO 13849-1:2008)	Up to category 2 (EN 13849-1: 2007)	3 (EN 954-1)
Performance level	e	e		
Function	Category 0 emergency stop module safety gates (mech. switches)	Category 0 emergency stop module safety gates (mech. switches)	Category 1 emergency stop module	Category 1 emergency stop module
<b>Output specifications</b>				
	2 x NO safety relay	3 x NO safety relay + 1 NC relay	1 x NO safety relay instant 1 x NO safety relay delayed 1 x NO auxiliary relay instant	3 x NO safety relay + 1 NC relay
Max. load AC1	6 A @ 230 VAC	6 A @ 230 VAC	5 A @ 230 VAC	6 A @ 230 VAC
Max. load DC12	6 A @ 24 VDC	6 A @ 24 VDC	5 A @ 24 VDC	
Electrical life	> 10 <sup>5</sup> operations	> 10 <sup>5</sup> operations	> 10 <sup>5</sup> operations	> 10 <sup>5</sup> operations
<b>Input specifications</b>				
Type	2 x NO, voltage free	2 x NO, voltage free	2 x NO, voltage free	
<b>General specifications</b>				
Power supply	24 VAC / DC -15% +10%	24 VAC / DC -15% +10%	24 VAC / DC ±10%	18 VAC ±10% 24 VDC ±10%
Screw terminals	Fixed [SA, SC] Detachable [DA, DC]	Fixed [SA, SC] Detachable [DA, DC]	Fixed [SA] Detachable [DA]	Fixed
Start	Automatic / Manual [SA, DA] Monitored manual [SC, DC]	Automatic / Manual [SA, DA] Monitored manual [SC, DC]	Automatic / Manual	Automatic / Manual
Approvals / Marks	CE - UL - TÜV	CE - UL - TÜV	CE	CE - UL
<b>References</b>				
	<b>NES02DB24SA</b>	<b>NES13DB24SA</b>	<b>NDS12BB24SA</b>	<b>NA13CT</b>
	<b>NES02DB24SC</b>	<b>NES13DB24SC</b>	<b>NDS12BB24DA</b>	
	<b>NES02DB24DA</b>	<b>NES13DB24DA</b>		
	<b>NES02DB24DC</b>	<b>NES13DB24DC</b>		

# Safety modules





	Two hand device	Safety mat & edge	
Types	ND12D	NSE02C	NST02C
			
Dimensions HxWxD (mm)	99 x 22.5 x 114	80 x 22.5 x 99.5	80 x 22.5 x 99.5
Safety category	4 (EN 954-1)	3 (EN 13849-1: 2007)	3 (EN 13849-1: 2007)
Performance level		b (EN ISO 13849-1:2008)	b (EN ISO 13849-1:2008)
Function	Two hand device	Safety mat & edge module	Safety mat module
<b>Output specifications</b>			
	2 x NO safety relay	2 x NO safety relay	2 x NO safety relay
Max. load AC1	8 A @ 230 VAC	5 A @ 230 VAC	5 A @ 230 VAC
Max. load DC12		5 A @ 24 VDC	5 A @ 24 VDC
Electrical life	> 10 <sup>5</sup> operations	> 10 <sup>5</sup> operations	> 10 <sup>5</sup> operations
<b>Input specifications</b>			
Type	2 x NO, 2 x NC, voltage free	2-wire mats or safety edges	4-wire mats (SM...)
<b>General specifications</b>			
Power supply	24 VAC/DC -15% +10% 110 VAC -15% +10% [110CG] 230 VAC -15% +10% [230CG]	24 VAC/DC ±15%	24 VAC/DC ±15%
Screw terminals	Fixed	Fixed	Fixed
Start	Automatic	Automatic / Manual [SA, DA] Monitored manual [SC, DC]	Automatic / Manual [SA, DA] Monitored manual [SC, DC]
Approvals / Marks	CE - UL - TÜV	CE - TÜV	CE - TÜV
<b>References</b>			
	<b>ND12D</b>	<b>NSE02CB24SA</b>	<b>NST02CB24SA</b>
	<b>ND12D110CG</b>	<b>NSE02CB24SC</b>	<b>NST02CB24SC</b>
	<b>ND12D230CG</b>		

# Safety modules

## Safety gates (magnetic sensors)

Types	NSO02	NSO13	NSC02	NSC13
				
Dimensions HxWxD (mm)	99 x 22.5 x 114	99 x 22.5 x 114	99 x 22.5 x 114	99 x 22.5 x 114
Safety category	Up to category 4 (EN ISO 13849-1:2008)	Up to category 4 (EN ISO 13849-1:2008)	Up to category 4 (EN ISO 13849-1:2008)	Up to category 4 (EN ISO 13849-1:2008)
Performance level				
Function	Safety gates module	Safety gates module	Safety gates module	Safety gates module
<b>Output specifications</b>				
	2 x NO safety relay	3 x NO safety relay + 1 NC relay	2 x NO safety relay	3 x NO safety relay + 1 NC relay
Max. load AC1	6 A @ 230 VAC	6 A @ 230 VAC	5 A @ 230 VAC	6 A @ 230 VAC
Max. load DC12	6 A @ 24 VDC	6 A @ 24 VDC	6 A @ 24 VDC	6 A @ 24 VDC
Electrical life	> 10 <sup>5</sup> operations	> 10 <sup>5</sup> operations	> 10 <sup>5</sup> operations	> 10 <sup>5</sup> operations
<b>Input specifications</b>				
Type	2 x NO, SMS or mechanical	2 x NO, SMS or mechanical	1 x NO, 1 x NC, SMS or mechanical	1 x NO, 1 x NC, SMS or mechanical
<b>General specifications</b>				
Power supply	24 VAC/DC -15% +10%	24 VAC/DC -15% +10%	24 VAC/DC -15% +10%	24 VAC/DC -15% +10%
Screw terminals	Fixed [SA, SC] Detachable [DA, DC]	Fixed [SA, SC] Detachable [DA, DC]	Fixed [SA, SC] Detachable [DA, DC]	Fixed [SA, SC] Detachable [DA, DC]
Start	Automatic / Manual [SA, DA] Monitored manual [SC, DC]	Automatic / Manual [SA, DA] Monitored manual [SC, DC]	Automatic / Manual [SA, DA] Monitored manual [SC, DC]	Automatic / Manual [SA, DA] Monitored manual [SC, DC]
Approvals / Marks	CE - UL - TÜV	CE - UL - TÜV	CE - UL - TÜV	CE - UL - TÜV
<b>References</b>				
	<b>NSO02DB24SA</b>	<b>NSO13DB24SA</b>	<b>NSC02DB24SA</b>	<b>NSC13DB24SA</b>
	<b>NSO02DB24SC</b>	<b>NSO13DB24SC</b>	<b>NSC02DB24SC</b>	<b>NSC13DB24SC</b>
	<b>NSO02DB24DA</b>	<b>NSO13DB24DA</b>	<b>NSC02DB24DA</b>	<b>NSC13DB24DA</b>
	<b>NSO02DB24DC</b>	<b>NSO13DB24DC</b>	<b>NSC02DB24DC</b>	<b>NSC13DB24DC</b>

## Safety modules

	Safety light curtains	Lift levelling	Standstill monitor	Exstensions
Types	NLG02D NLG13D	NA12DLIFT	MF1C	NE14D
				
Dimensions HxWxD (mm)	99 x 22.5 x 114	99 x 22.5 x 114	80 x 45 x 99.5	99 x 22.5 x 114
Safety category	Up to category 4 (EN 954-1)		3 (EN 954-1)	Up to category 4
Performance level	<sup>e</sup> (EN ISO 13849-1:2008)			<sup>e</sup> (EN ISO 13849-1:2008)
Function	Light curtains safety modules	Lift levelling module (EN 81-1, 81-2, EN 12015, EN 12016)	Standstill monitor safety module 1-phase or 3-phase	Extension safety module
<b>Output specifications</b>				
	2 x NO safety relay [NLG02] 3 x NO safety relay + 1 NC relay [NLG13]	2 x NO safety relay	2 x NO safety relay	4 x NO safety relay + 1NC (feedback)
Max. load AC1	6 A @ 230 VAC	6 A @ 230 VAC	8 A @ 230 VAC	8 A @ 230 VAC
Max. load DC12	6 A @ 24 VDC			
Electrical life	> 10 <sup>5</sup> operations	> 10 <sup>5</sup> operations	> 10 <sup>5</sup> operations	> 10 <sup>5</sup> operations
<b>Input specifications</b>				
Type	2 x NO min 10 mA / 17 V max 60 mA / 38 V [NLG02] max 30 mA / 38 V	2 x NO	Up to 500 VAC	2 x NO, voltage free
<b>General specifications</b>				
Power supply	24 VDC - 15% +10%	24 VAC/DC ±15%	24 VAC/DC ±15%	24 VAC/DC -15% +10% 110 VAC -15% +10% [110CG] 230 VAC -15% +10% [230CG]
Screw terminals	Fixed [SA, SC] Detachable [DA, DC]	Fixed	Fixed	Fixed
Start	Automatic / Manual [SA, DA] Monitored manual [SC, DC]			
Approvals / Marks	CE - UL - TÜV	CE - TÜV	CE - UL - TÜV	CE - UL - TÜV
<b>References</b>				
	NLG02D724SA	NA2DLIFT	MF1C	NE14D
	NLG02D724SC			NE14D110CG
	NLG02D724DA			NE14D230CG
	NLG02D724DC			
	NLG13D724SA			
	NLG13D724SC			
	NLG13D724DA			
	NLG13D724DC			

# Configurable safety modules

<b>Types</b>	<b>CERTUS Master Module</b>
	<b>CMM</b>
	
Dimensions HxWxD (mm)	99 x 22.5 x 114
Safety category	4
Safety level	SIL 3, according to IEC 61508 SIL CL 3, according to IEC 62061 PLe and Cat. 4, according to ISO/EN 13489-1
Performance level	e
Function	Can stand-alone managing and monitoring different safety sensors and commands at the same time. Manages up to 14 expansion units

## Safety inputs and outputs specifications



CMM as a stand alone unit	- 8 digital inputs, PNP active high according to EN 61131-2 - 2 pairs of solid state programmable safety outputs (OSSD), PNP active high 400 mA at 24 VDC max
Max. digital inputs with expansion modules	128
Max. digital outputs with expansion modules	16 pairs (OSD)
Max. n° of expansion modules	14

## Non-Safety inputs and outputs specifications

Test outputs	4
Programmable digital signal outputs	2
Input for Start/Restart interlock and EDM	2

## General specifications

Rated voltage	24 VDC ±20% / supply from Class II
Digital inputs	PNP active high, according to EN 61131-2
OSSD	PNP active high - 400 mA @ 24 VDC
Enclosure protection class	IP 20
Terminal blocks protection class	IP 2x

<b>Types</b>	<b>I/O Expansion Modules</b>		
	<b>C 8I 20</b>	<b>C 8I / C 16I</b>	<b>C 12I 8TO</b>
			
Dimensions HxWxD (mm)	99 x 22.5 x 114		
Safety category	4		
Performance level	e		
Function	expansion modules		

## General specifications

PFHd (IEC 61508:1998)	5.72E-9	5.75E-9 (C 8I); 7.09E-9 (C 16I)	3.24E-9
Rated voltage	24 VDC ±20%		
Dissipated power	3 W max		
Digital inputs	8 / PNP active high according to EN 61131-2	8 (C 8I) / 16 (C 16I)	12 / PNP active high according to EN 61131-2
Test output	4 for sensor monitoring and checking short-circuits and overloads	4 for sensor monitoring and checking short-circuits and overloads	8 for sensor monitoring and checking short-circuits and overloads

# Configurable safety modules

## OSSD + standard Relay Expansion Modules

### Types

#### C 2OSSD / C 4OSSD

#### C 2R / C 4R



Dimensions HxWxD (mm)	99 x 22.5 x 114
Safety category	4
Performance level	e
Function	expansion modules

### General specifications

PHFd (IEC 61508:1998)	3.16E-9 (C 2OSSD) / 3.44E-9 (C 4OSSD)
Rated voltage	24 VDC ±20%
Dissipated power	3 W max
Digital output	2 (C 2OSSD); 4 (C 4OSSD)
Switching voltage	240 VAC
Switching current	6 A max
Contacts	2 NO + 1 NC (C 2R) connectable to 1 OSSD pair 4 NO + 2 NC (C 4R) connectable to 2 OSSD pairs

## Data and Diagnostics Communication + Bus Transfer Expansion Modules

### Types

#### C DDC

#### C BT



Dimensions HxWxD (mm)	99 x 22.5 x 114
Safety category	4
Performance level	e

Function	Communication with most common industrial fieldbus system	Interface expansion module allowing the connection of remote expansions. Ideal solution for the interconnection of the safety functions of several machines in a production line
----------	---	--

### General specifications



Connection	Shielded cable compatible with RS485
Max connection distance	100 m
Max number of CBT modules per system	5

References	C PFBUS - Profibus C DNET - DeviceNET C CAN - CANopen C EIP - Ethernet IP C ECAT - EtherCAT C PFNET - PROFINET C OMMS - Universal Serial Bus	C BT1 – 1 connection (1 input or 1 output) C BT2 – 2 connections (1 input and 1 output)  The C BT1 is placed at the beginning or at the end of the network connected with a single cable, whilst the C BT2 goes in the middle.
------------	--	---







# Switching power supplies

## Single phase switching power supplies

Types	5 / 10 / 18 W				30 / 60 W			90 / 100 W		
										
Dimensions HxWxD (mm)	90 x 22.5 x 114				90 x 40.5 x 114			90 x 54 x 114		
<b>Output specifications</b>										
Voltage	5 VDC	12 VDC	15 VDC	24 VDC	12 VDC	24 VDC	48 VDC	12 VDC	24 VDC	48 VDC
Current SPD 5 W	1 A	420 mA	340 mA	210 mA						
Current SPD 10 W	2 A	840 mA	670 mA	420 mA						
Current SPD 18 W	3 A	1.5 A	1.2 A	750 mA						
Current SPD 30 W					2.5 A	1.25 A	625 mA			
Current SPD 60 W					5 A	2.5 A	1.25 A			
Current SPD 90 W									3.8 A	
Current SPD 100 W								8.4 A	4.2 A	2.1 A
Line regulation		±1%				±0.5%			±1%	
Load regulation		±2%				±0.5%			±1%	
Efficiency	75%	77%	77%	77%	86%	89%	89%		85%	
<b>Input specifications</b>										
Voltage range	Multi voltage: 90 to 265 VAC or 120 to 370 VDC				Multi voltage: 85 to 264 VAC or 90 to 375 VDC			Multi voltage: 90 to 264 VAC or 120 to 375 VDC		
Frequency range	47 to 63 Hz				47 to 63 Hz			47 to 63 Hz		
<b>General specifications</b>										
Ambient temperature	-40°C to +71°C				-40°C to +71°C			-35°C to +71°C		
Storage	-40°C to +85°C				-40°C to +85°C			-40°C to +85°C		
Derating (>60°C)	3 % / °C				2.5 % / °C			2.5 % / °C		
Approvals / Marks	cULus - TÜV - CE - Class I DIV2				cULus - TÜV - CE - Class I DIV2			cULus - TÜV - CE - Class I DIV2		
Installation	DIN Rail				DIN Rail			DIN Rail		
Connection	Screw terminals / Spring terminals (B)				Screw terminals / Spring terminals (B)			Screw terminals / Spring terminals (B)		
<b>Main features</b>										
	Adjustable output voltage. Internal noise filter. Short circuit protection. Overload protection (110-135%)				Adjustable output voltage. Internal noise filter. Short circuit protection. Overload protection (110-135%). Output "Power ready" signal VDC (only model 24 VDC).			Adjustable output voltage. Internal noise filter. Short circuit protection. Overload protection (102-108%), PFC. Overvoltage protection (102-106%). Output "Power ready" signal VDC.		
LED indicator for "power on"	Yes				Yes			Yes		
LED indicator for DC "too low"	Yes				No - SPD24 with transistor output			Yes with relay output		
<b>References</b>										
<b>5 VDC</b>										
Screw terminals	SPD05051 / SPD05101 SPD05181									
Spring terminals	SPD05051B / SPD05101B SPD05181B									
<b>12 VDC</b>										
Screw terminals	SPD12051 / SPD12101 SPD12181				SPD12301 / SPD12601			SPD121001		
Spring terminals	SPD12051B / SPD12101B SPD12181B				SPD12301B / SPD12601B					
<b>24 VDC</b>										
Screw terminals	SPD24051 / SPD24101 SPD24181				SPD24301 / SPD24601			SPD24901L / SPD241001L		
Spring terminals	SPD24051B / SPD24101B SPD24181B				SPD24301B / SPD24601B					
<b>48 VDC</b>										
Screw terminals					SPD48301 / SPD48601			SPD481001		
Spring terminals					SPD48301B / SPD48601B					





# Switching power supplies

## Single phase switching power supplies



Types	120 W / 120 W(N)			240 W		300 W		480 W	
									
Dimensions HxWxD (mm)	124.5 x 64 x 123.6			124.5 x 83.5 x 123.6		124.5 x 83.5 x 123.6		124.5 x 175.5 x 123.6	
<b>Output specifications</b>									
Voltage	12 VDC	24 VDC	48 VDC	24 VDC	48 VDC	24 VDC	48 VDC	24 VDC	48 VDC
Current	10 A	5 A	2.5 A	10 A	5 A	12.5 A	6.25 A	20 A	10 A
Line regulation		±0.5%	±0.5%		±0.5%		±0.5%		±0.5%
Load regulation		±1%	±1%		±1%		±1%		±1%
Efficiency	84%	86%	86%	89%	90%	89%	90%	89%	90%
<b>Input specifications</b>									
Voltage range	Autoselect: 90 to 132 VAC, 180 to 264 VAC, 120 to 375 VDC			Autoselect: 90 to 132 VAC, 180 to 264 VAC, 120 to 375 VDC		Autoselect: 90 to 132 VAC, 180 to 264 VAC, 120 to 375 VDC		Autoselect: 90 to 132 VAC, 186 to 264 VAC, 120 to 370 VDC	
Frequency range	47 to 63 Hz			47 to 63 Hz		47 to 63 Hz		47 to 63 Hz	
PFC	0.7			0.75		0.75		0.99	
<b>General specifications</b>									
Ambient temperature	-35°C to +71°C			-40°C to +71°C		-30°C to +71°C		-40°C to +71°C	
Storage	-40°C to +85°C			-40°C to +85°C		-40°C to +85°C		-40°C to +85°C	
Derating (>60°C)	2.5 % / °C			2.5 % / °C		2.5 % / °C		2.5 % / °C > 56°C	
Approvals / Marks	cULus - TÜV - CE - Class DIV2			cULus - TÜV - CE - Class DIV2		cULus - TÜV - CE - Class DIV2		cULus - TÜV - CE - Class DIV2	
Installation	DIN Rail			DIN Rail		DIN Rail		DIN Rail	
Connection	Screw terminals / Spring terminals (B)			Screw terminals / Spring terminals (B)		Screw terminals / Spring terminals (B)		Screw terminals / Spring terminals (B)	
<b>Main features</b>									
	Adjustable output voltage. Internal noise filter. Short circuit protection. Overload protection (110-145%). Parallel connection up to 3 supplies and PFC function on (N) model only			Adjustable output voltage. Internal noise filter. Short circuit protection. Overload protection (110-145%). Parallel connection up to 3 supplies standard. PFC function integrated		Parallel function, PFC and Output ready		Adjustable output voltage. Internal noise filter. Short circuit protection. Overload protection (120-140%). Parallel connection up to 3 supplies standard. PFC function integrated	
LED indicator for "power on"	Yes			Yes		Yes, 24 V with output ready		Yes	
LED indicator for DC "too low"	Yes - with relay output (SPD24 only)			Yes - with relay output (SPD24 only)		Yes		Yes - with relay output (SPD24 only)	
<b>References</b>									
<b>12 VDC</b>									
Screw terminals	SPD121201 SPD121201N								
Detach. screw terminals	SPD121201B SPD121201BN								
<b>24 VDC</b>									
Screw terminals	SPD241201 SPD241201N			SPD242401		SPD243001		SPD244801	
Detach. screw terminals	SPD241201B SPD241201BN			SPD242401B		SPD243001B		SPD244801B	
<b>48 VDC</b>									
Screw terminals	SPD481201 SPD481201N			SPD482401		SPD483001		SPD484801	
Detach. screw terminals	SPD481201B SPD481201BN			SPD482401B		SPD483001B		SPD484801B	

# Switching power supplies

## Three phase switching power supplies





Types	SPD 120 W 3-ph		SPD 240 W 3-ph		SPD 480 W 3-ph		SPD 960 W 3-ph	
								
Dimensions HxWxD (mm)	124 x 74.3 x 118.8		124 x 89.0 x 118.8		124 x 150 x 118.8		126.2 x 275.8 x 118.8	
<b>Output specifications</b>								
Voltage	12 VDC	24 VDC	24 VDC	48 VDC	24 VDC	48 VDC	24 VDC	48 VDC
Current	10 A	5 A	10 A	5 A	20 A	10 A	40 A	20 A
Line regulation	±1%		±1%		±1%		±1%	
Load regulation	±1%		±1%		±1%		±1%	
Efficiency	87%	89%	90%	91%	90%	91%	92%	93%
<b>Input specifications</b>								
Voltage range	340 to 575 VAC 480 to 820 VDC		340 to 575 VAC 480 to 820 VDC		340 to 575 VAC 480 to 820 VDC		340 to 575 VAC 480 to 820 VDC	
Frequency range	47 to 63 Hz		47 to 63 Hz		47 to 63 Hz		47 to 63 Hz	
PFC	0.55		0.55		0.65		0.80	
<b>General specifications</b>								
Ambient temperature	-40°C to +71°C		-25°C to +71°C		-30°C to +71°C		-40°C to +71°C	
Storage	-40°C to +85°C		-25°C to +85°C		-40°C to +85°C		-40°C to +85°C	
Derating	2.5 % / °C > 61°C		2.5 % / °C > 61°C		2.5 % / °C > 61°C		3.5 % / °C > 61°C	
Approvals / Marks	cULus - TÜV - CE		cULus - TÜV - CE		cULus - TÜV - CE		cULus - TÜV - CE	
Installation	DIN Rail		DIN Rail		DIN Rail		DIN Rail	
Connection	Screw terminals		Screw terminals		Screw terminals / Detach conn.		Screw terminals	
<b>Main features</b>								
	Can be used as Bi or Three phase, Parallel function and PFC		Can be used as Bi or Three phase, Parallel function and PFC		Can be used as Bi or Three phase, Parallel function and PFC		Can be used as Bi or Three phase. Active parallel function and PFC	
LED indicator for "power on"	Yes, 24 V with output ready		Yes, 24 V with output ready		Yes, 24 V with output ready		Yes, 24 V with output ready	
LED indicator for DC "too low"	Yes		Yes		Yes		Yes	
<b>References</b>								
<b>12 VDC</b>								
Screw terminals	SPD121203							
<b>24 VDC</b>								
Screw terminals	SPD241203		SPD242403		SPD244803 SPD244803B		SPD249603 SPD249603L (without parallel function and output ready)	
<b>48 VDC</b>								
Screw terminals			SPD482403		SPD484803 SPD484803B		SPD489603	

# Switching power supplies, redundant modules

	Bi-phase switching power supplies			Redundant modules	
Types	100 W			SPD Redundant Module	SPM Redundant Module
					
Dimensions HxWxD (mm)	90 x 54 x 114			90 x 54 x 114	91 x 35 x 56
<b>Output specifications</b>					
Voltage	12 VDC	24 VDC	48 VDC	24 VDC	24 VDC
Current	8.4 A	4.2 A	2.1 A	20 A	10 A
Line regulation	±1%				
Load regulation	±1%				
Efficiency	86%	87%	89%		
<b>Input specifications</b>					
Voltage range	340 to 575 VAC, 480 to 820 VAC			21 to 28 VDC	21 to 48 VDC
Frequency range	47 to 63Hz				
PFC	0.55				
<b>General specifications</b>					
Ambient temperature	-40°C to +71°C			-40°C to +71°C	
Storage	-40°C to +85°C			-40°C to +85°C	
Derating (>60°C)	2.5% / °C				
Approvals / Marks	cULus - TÜV - CE - Class I DIV2			cULus - TÜV - CE	
Installation	DIN Rail			DIN Rail	DIN Rail
Connection	Screw terminals			Screw terminals	Screw terminals
<b>Main features</b>					
	Parallel function, PFC and Output ready			2 Relay outputs for remote monitoring	
LED indicator for "power on"	Yes - with relay output (SPD24 only)			Yes - with relay output (SPD24 only)	
LED indicator for DC "too low"	Yes				
<b>References</b>					
<b>12 VDC</b>					
Screw terminals	<b>SPD121002</b>				
<b>24 VDC</b>					
Screw terminals	<b>SPD241002</b>	<b>SPD24RM20</b>		<b>SPM2RM2410</b>	
<b>48 VDC</b>					
Screw terminals	<b>SPD481002</b>				

# Switching power supplies

## Low profile DIN rail mounting

Types	SPM 1	SPM 3	SPM 4	SPM 5
				
Dimensions HxWxD (mm)	91 x 18 x 55.5	91 x 52 x 55.5	91 x 71 x 55.5	91 x 90 x 55.5
<b>Output specifications</b>				
Voltage	5 VDC, 12 VDC, 15 VDC, 24 VDC	5 VDC, 12 VDC, 15 VDC, 24 VDC	5 VDC, 12 VDC, 15 VDC, 24 VDC	5 VDC, 12 VDC, 15 VDC, 24 VDC, 24 VDC (S ver.)
Current	1.5 A - 0.83 A 0.67 A - 0.42 A	3.0 A - 2.1 A 2.0 A - 1.3 A	7.0 A - 4.5 A 4.0 A - 2.5 A	12 A - 6 A - 5 A 4.2 A - 3.8 A
Line regulation	±1%	±1%	±1%	±1%
Load regulation	±1%	±1%	±1%	±1%
<b>Input specifications</b>				
Voltage range	Autoselec.. 90 to 264 VAC, 120 to 370 VDC	Autoselec.. 90 to 264 VAC, 120 to 370 VDC	Autoselec.: 90 to 264 VAC, 120 to 370 VDC	Autoselec.: 90 to 264 VAC, 120 to 370 VDC
Frequency range	47 to 63 Hz	47 to 63 Hz	47 to 63 Hz	47 to 63 Hz
<b>General specifications</b>				
Ambient temperature	-25°C to +71°C	-25°C to +71°C	-25°C to +71°C	-25°C to +71°C
Storage	-25°C to +85°C	-25°C to +85°C	-25°C to +85°C	-25°C to +85°C
Derating (>60°C)	2.5 % / °C	2.5 % / °C	2.5 % / °C	2.5 % / °C
Approvals / Marks	cULus - TÜV - CE - Class1 DIV2	cULus - TÜV - CE - Class1 DIV2	cULus - TÜV - CE - Class1 DIV2	cULus - TÜV - CE - Class1 DIV2
Installation	DIN Rail	DIN Rail	DIN Rail	DIN Rail
Connection	Screw terminals	Screw terminals	Screw terminals	Screw terminals
<b>Main features</b>				
		Adjustable output voltage	Adjustable output voltage	Adjustable output voltage
LED indicator for "power on"	Yes	Yes	Yes	Yes
LED indicator for DC "too low"	Yes	Yes	Yes	Yes
<b>References</b>				
5 VDC	<b>SPM1-051</b>	<b>SPM3-051</b>	<b>SPM4-051</b>	<b>SPM5-051</b>
12 VDC	<b>SPM1-121</b>	<b>SPM3-121</b>	<b>SPM4-121</b>	<b>SPM5-121</b>
15 VDC	<b>SPM1-151</b>	<b>SPM3-151</b>	<b>SPM4-151</b>	<b>SPM5-151</b>
24 VDC	<b>SPM1-241</b>	<b>SPM3-241</b>	<b>SPM4-241</b>	<b>SPM5-241</b>
24 VDC (class 2 UL)				<b>SPM5-241S</b>



# Switching power supplies

## Enclosed switching power supplies

Types	SPPC 25 W	SPPC 35 W	SPPC 50 W	SPPC 75 W
				
Dimensions HxWxD (mm)	79 x 51 x 28.8	101.6 x 63.5 x 33	99 x 82 x 35	129 x 98 x 38
<b>Output specifications</b>				
Voltage	5 V, 12 V, 24 V	5 V, 12 V, 24 V	5 V, 12 V, 15 V, 24 V, 48 V	5 V, 12 V, 24 V, 48 V
Current	5 A, 2.1 A, 1.1 A	6 A, 3 A, 1.5 A	8 A, 4.2 A, 3.4 A, 2.2 A, 1.12 A	12 A, 6 A, 3.2 A, 1.62 A
Line regulation	±0.5%	±0.5%	±0.5%	±0.5%
Load regulation	±2.0%, ±1.0%, ±1.0%	±1.0%	±1.0%	±2.0%
Efficiency (typ)	115 VAC 230 VAC	76%, 80%, 84% 78%, 82%, 85%	79%, 83%, 86% 80%, 84%, 87%	79%, 84%, 87%, 88% 80%, 85%, 88%, 89%
<b>Input specifications</b>				
Voltage range	90 to 264 VAC 127 to 370 VDC	90 to 264 VAC 127 to 370 VDC	90 to 264 VAC 27 to 370 VDC	90 to 264 VAC 127 to 370 VDC
Frequency range	47 to 63 Hz	47 to 63 Hz	47 to 63 Hz	47 to 63 Hz
<b>General specifications</b>				
Ambient temperature	-25°C to +70°C	-25°C to +70°C	-25°C to +70°C	-25°C to +70°C
Storage	-40°C to +85°C	-40°C to +85°C	-40°C to +85°C	-40°C to +85°C;
Derating (>50°C)	2% / °C	2% / °C	1.5% / °C	1.5% / °C
Cooling	Free air convection	Free air convection	Free air convection	Free air convection
Approvals / Marks	UL60950-1 2 <sup>nd</sup> Ed; IEC 60950-1:2005 (2 <sup>nd</sup> Ed); EN60950-1:2006	UL60950-1 2 <sup>nd</sup> Ed; IEC 60950-1:2005 (2 <sup>nd</sup> Ed); EN60950-1:2006	UL60950-1 2 <sup>nd</sup> Ed; IEC 60950-1:2005 (2 <sup>nd</sup> Ed); EN60950-1:2006	UL60950-1 2 <sup>nd</sup> Ed; IEC 60950-1:2005 (2 <sup>nd</sup> Ed); EN60950-1:2006
Installation	Screw terminal	Screw terminal	Screw terminal	Screw terminal
<b>Main features</b>				
Mounting	Horizontal and Vertical (DIN rail mounting accessories available)	Horizontal and Vertical (DIN rail mounting accessories available)	Horizontal and Vertical (DIN rail mounting accessories available)	Horizontal and Vertical (DIN rail mounting accessories available)
<b>References</b>				
5 VDC	SPPC 525 1	SPPC 535 1	SPPC 550 1	SPPC 575 1
12 VDC	SPPC 1225 1	SPPC 1235 1	SPPC 1250 1	SPPC 1275 1
15 VDC			SPPC 1550 1	
24 VDC	SPPC 2425 1	SPPC 2435 1	SPPC 2450 1	SPPC 2475 1
48 VDC			SPPC 4850 1	SPPC 4875 1

# Switching power supplies

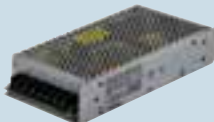
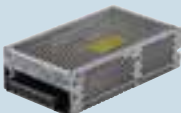
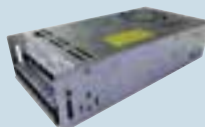
## Compact enclosed switching power supplies

Types	SPPC 150 W	SPPC 150 W (PFC) Power Factor Correction	SPPC 200 W	SPPC 240 W
				
Dimensions HxWxD (mm)	199 x 98 x 38	194 x 99 x 50	199 x 99 x 50	199 x 99 x 50
<b>Output specifications</b>				
Voltage	5 VDC, 12 VDC, 15 VDC, 24 VDC, 48 VDC	5 VDC, 12 VDC, 15 VDC, 24 VDC, 48 VDC	5 V, 12 V, 24 V, 48 V	12 V, 24 V
Current	26 A, 12.5 A, 10 A, 6.5 A, 3.3A	30 A, 12.5 A, 10 A, 6.3 A, 3.2 A	40 A, 16.7 A, 8.4 A, 4.2 A	20 A, 10 A
Line regulation	± 0.5%	± 0.5%	±0.5%	±0.5%
Load regulation	±1%	±1%	±1.0%	±1.0%
Efficiency (typ)	up to 85%	up to 87%	79%, 84%, 86%, 87.5%	84%, 86%
Built-in active PFC		PFC > 0.98 @ 115 VAC; PFC > 0.95 @ 230 VAC	(115 VAC): PF>0.98 (230 VAC): PF>0.96	(115 VAC): PF>0.98 (230 VAC): PF>0.96
<b>Input specifications</b>				
Voltage range	88 to 132 VAC 176 to 264 VAC 124 to 186 VDC 248 to 370 VDC	88 to 264 VAC 124 to 370 VDC	85 to 264 VAC 120 to 370 VDC	85 to 264 VAC 120 to 370 VDC
Frequency range	47 to 63 Hz	47 to 63 Hz	47 to 63 Hz	47 to 63 Hz
<b>General specifications</b>				
Ambient temperature	-25°C to +70°C	-25°C to +70°C	-25°C to +70°C	-25°C to +70°C
Storage	-40°C to +85°C	-30°C to +85°C	-40°C to +85°C	-40°C to +85°C
Output short circuit	Long-term, Auto recovery	Long-term, Auto recovery	Long-term, Auto recovery	Long-term, Auto recovery
Derating (>50°C)	2.5% / °C	2.5% / °C	2% / °C	2% / °C
Cooling	Free air convection	Free air convection	Forced air (built-in DC fan controlled by load and internal temperature)	Forced air (built-in DC fan controlled by load and internal temperature)
Approvals / Marks	CE - cURus - RoHS	CE - cURus - RoHS - CB	UL60950-1 2 <sup>nd</sup> Ed; IEC 60950-1:2005 (2 <sup>nd</sup> Ed); EN60950-1:2006	UL60950-1 2 <sup>nd</sup> Ed; IEC 60950-1:2005 (2 <sup>nd</sup> Ed); EN60950-1:2006
Installation	Screw terminal	Screw terminal	Screw terminal	Screw terminal
<b>Main features</b>				
Mounting	Horizontal and Vertical (DIN rail mounting accessories available)	Horizontal and Vertical (DIN rail mounting accessories available)	Horizontal and Vertical (DIN rail mounting accessories available)	Horizontal and Vertical (DIN rail mounting accessories available)
<b>References</b>				
5 VDC	SPPC-5150 1	SPPC-5150 1F	SPPC 5200 1FC	
12 VDC	SPPC-12150 1	SPPC-12150 1F	SPPC 12200 1FC	SPPC 12240 1FC
15 VDC	SPPC-15150 1	SPPC-15150 1F		
24 VDC	SPPC-24150 1	SPPC-24150 1F	SPPC 24200 1FC	SPPC 24240 1FC
48 VDC	SPPC-48150 1	SPPC-48150 1F	SPPC 48200 1FC	

# Switching power supplies

## Compact enclosed switching power supplies

Types	SPPC 320 W	SPPC 480 W	SPPC 600 W	SPPC 800 W
				
Dimensions HxWxD (mm)	199 x 99 x 50	218 x 116.5 x 41	218 x 116.5 x 41	226 x 116.5 x 41
<b>Output specifications</b>				
Voltage	5 V, 12 V, 24 V, 48 V	12 V, 24 V, 36 V, 48 V	12 V, 24 V, 36 V, 48 V	24 V, 48 V
Current	55 A, 25 A, 13 A, 6.7 A	34 A, 22 A, 14 A, 11 A	(100 to 127 VAC): 34 A, 22 A, 14 A, 11 A (128 to 264 VAC): 42 A, 26.5 A, 17.5 A, 13.6 A	(100 to 127 VAC): 27 A, 14 A (128 to 264 VAC): 33 A, 16.5 A
Line regulation	±0.5%	±0.5%, ±0.5%, ±0.5%, ±0.2%	±0.5%	±0.5%
Load regulation	±1.0%	±1.0%	±1.0%	±1.0%
Efficiency (typ)	79%, 84.5%, 87%, 87.5%	88%, 89%, 90%, 90%	88%, 89%, 90%, 90%	88%, 89%
Built-in active PFC	(115 VAC): PF>0.98 (230 VAC): PF>0.96	(115 VAC): PF>0.98 (230 VAC): PF>0.96	(115 VAC): PF>0.98 (230 VAC): PF>0.96	(115 VAC): PF>0.98 (230 VAC): PF>0.96
<b>Input specifications</b>				
Voltage range	85 to 264 VAC 120 to 370 VDC	90 to 264 VAC 127 to 370 VAC	90 to 264 VAC 127 to 370 VAC	90 to 264 VAC 127 to 370 VAC
Frequency range	47 to 63 Hz	47 to 63 Hz	47 to 63 Hz	47 to 63 Hz
<b>General specifications</b>				
Ambient temperature	-25°C to +70°C	-30°C to +70°C	-30°C to +70°C	-30°C to +70°C
Storage	-40°C to +85°C	-40°C to +85°C	-40°C to +85°C	-40°C to +85°C
Derating (>50°C)	2% / °C	2% / °C	2% / °C	2% / °C
Cooling	Forced air (built-in DC fan controlled by load and internal temperature)	Forced air (built-in DC fan controlled by load and internal temperature)	Forced air (built-in DC fan controlled by load and internal temperature)	Forced air (built-in DC fan controlled by load and internal temperature)
Approvals / Marks	UL60950-1 2 <sup>nd</sup> Ed; IEC 60950-1:2005 (2 <sup>nd</sup> Ed); EN60950-1:2006	UL60950-1 2 <sup>nd</sup> Ed; IEC 60950-1:2005 (2 <sup>nd</sup> Ed); EN60950-1:2006	UL60950-1 2 <sup>nd</sup> Ed; IEC 60950-1:2005 (2 <sup>nd</sup> Ed); EN60950-1:2006	UL60950-1 2 <sup>nd</sup> Ed; IEC 60950-1:2005 (2 <sup>nd</sup> Ed); EN60950-1:2006
Installation	Screw terminal	Screw terminal	Screw terminal	Screw terminal
<b>Main features</b>				
Mounting	Horizontal and Vertical (DIN rail mounting accessories available)	Horizontal and Vertical (DIN rail mounting accessories available)	Horizontal and Vertical (DIN rail mounting accessories available)	Horizontal and Vertical (DIN rail mounting accessories available)
<b>References</b>				
5 VDC	SPPC 5320 1FC			
12 VDC	SPPC 12320 1FC	SPPC 12480 1FC	SPPC 12600 1FC	
15 VDC		SPPC 24480 1FC	SPPC 24600 1FC	SPPC 24800 1FC
24 VDC	SPPC 24320 1FC	SPPC 36480 1FC	SPPC 36600 1FC	
48 VDC	SPPC 48320 1FC	SPPC 48480 1FC	SPPC 48600 1FC	SPPC 48800 1FC



# Switching power supplies

## Low profile switching power supply Battery Charger

**Types** **SPM5BC**



Dimensions HxWxD (mm) 91 x 90 x 57

### Output specifications

Rated voltage	12 VDC, 24 VDC, 12 VDC, 24 VDC
Charging voltage	13.6 VDC, 27.2 VDC, 13.6 VDC, 27.2 VDC
Current	2.5 A, 1.25 A, 4.5 A, 2.5 A
Line regulation	±1%
Load regulation	±1%
Efficiency (typ)	84%, 86%, 84%, 86%
min.	86%, 88%, 86%, 88%
max.	

### Input specifications

Voltage range	90 to 264 VAC 120 to 375 VDC
Frequency range	47 to 63 Hz

### General specifications

Ambient temperature	-40°C to +51°C
Storage	-40°C to +85°C
Derating (+51°C to +61°C)	2.5% /°C
Cooling	Free air convection
Approvals / Marks	IEC 60068-2-6, IEC 60068-2-27 EN 61000-6-3, EN 55022 Class B, EN 61000-3-2, EN 61000-3-3, EN 61000-6-2, EN 55024, EN 61000-4-2 level 4, EN 61000-4-3 level 3, EN 61000-4-4 level 4, EN 61000-4-5 L-N level 3, EN 61000-4-6 level 3, EN 61000-4-8 level 4, EN 61000-4-11, EN 61204-3, ENV 50204 Level 2
Installation	Screw terminal

### Main features

Mounting	Horizontal and Vertical (DIN rail mounting accessories available)
----------	--

### References

12 VDC 30 W	<b>SPM5BC 1230</b>
24 VDC 30 W	<b>SPM5BC 2430</b>
12 VDC 60 W	<b>SPM5BC 1260</b>
24 VDC 60 W	<b>SPM5BC 2460</b>

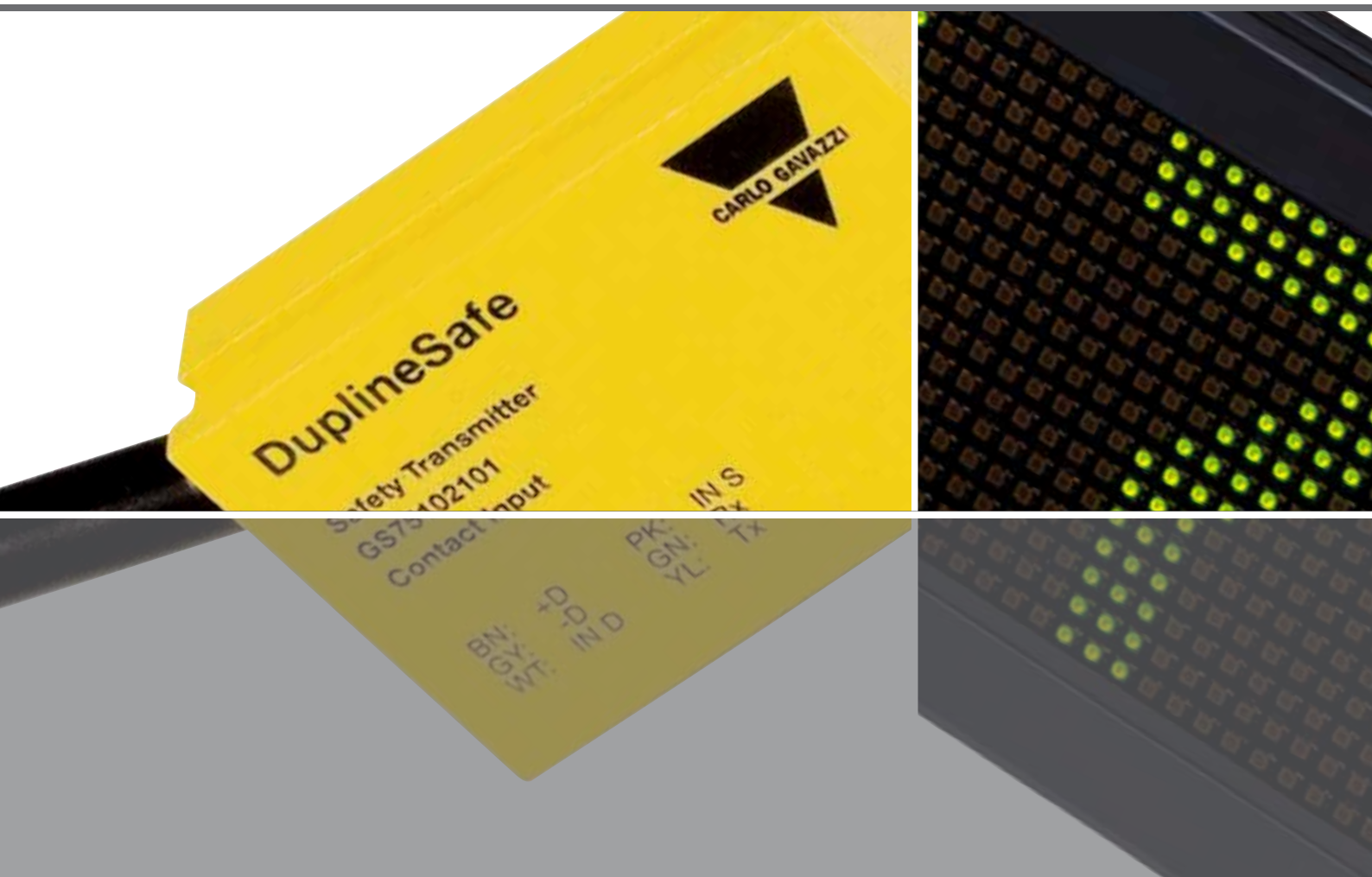



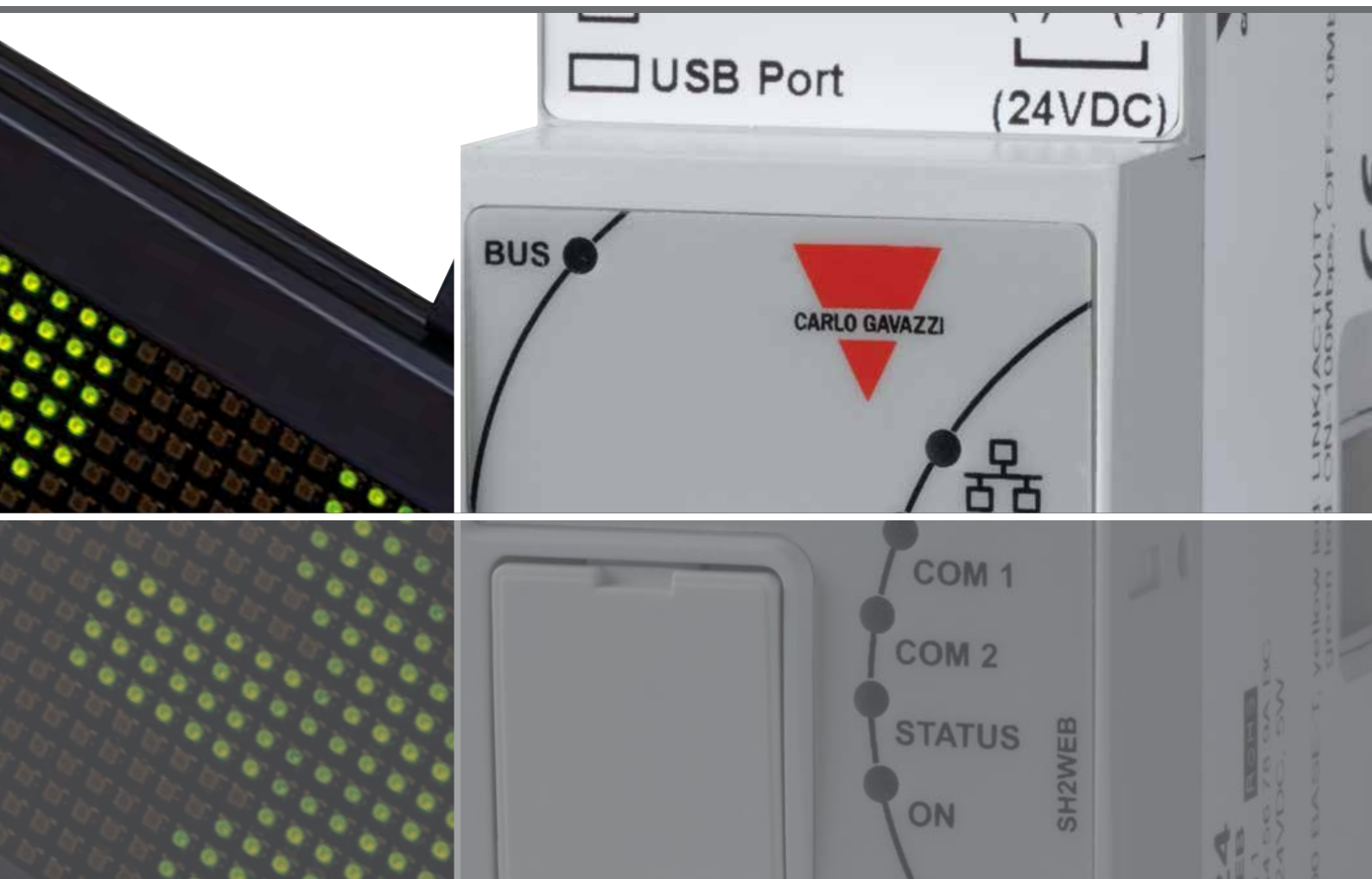

# Fieldbuses







Dupline® Home and Building automation	236
Dupline® Parking guidance system	251
Dupline® DuplineSafe	255
Dupline® Industrial	257
Dupline® Irrigation	270
Dupline® Elevator	271





# Dupline® Home and Building automation

	Controller		Bus generators	
Function	Home	Building	Wired	Wireless
				
Dimensions (mm)	2 DIN module	2 DIN module	2 DIN module	2 DIN module
Functions	Controller with home/building automation functions and energy data logging configurable by software	BACnet controller, BTL certified, converting Dupline and Energy Meter data points to BACnet/IP objects	Master channel generator	Wireless base unit for generating wireless network
<b>Electrical specifications</b>				
Power supply	24 VDC ± 20%	24 VDC ± 20%	24 VDC ± 20%	24 to 240 VAC/DC
<b>General specifications</b>				
LEDs	Green, yellow, blue, red	Green, yellow, blue, red	Green, yellow	Green, yellow, blue
Mounting	DIN-rail (2 modules)	DIN-rail (2 modules)	DIN-rail (2 modules)	DIN-rail (2 modules)
Degree of protection	Front: IP 40 Screw terminal: IP 20	Front: IP 40, Screw terminal: IP 20	Front: IP 40, Screw terminal: IP 20	Front: IP 40, Screw terminal: IP 20
Pollution degree	2 (IEC 60664-1, par. 4.6.2)		2 (IEC 60664-1, par. 4.6.2)	2 (IEC 60664-1, par. 4.6.2)
Operating temperature	-20°C to +50°C	-20°C to +50°C	-20°C to +50°C	-20°C to +50°C
Storage temperature	-30°C to +70°C	-30°C to +70°C	-50°C to +85°C	-50°C to +85°C
Humidity (non condensing)	90% @ 40°C	90% @ 40°C	20 to 80 %	20 to 80 %
Main features	Home automation master unit with datalogging capability. Linux based PC with 2 USB ports, ethernet port, 2 RS485 ports, local bus	Automatically creates BACnet/ IP objects for all Dupline and energy meter data points. Ethernet port for BACnet/IP communication	Dupline® bus generator. Connection of up to 250 slave modules	Wireless bus generator. Connection of up to 250 slave modules. Based on IEEE 802.15.4, @ 2.4 GHz
<b>References</b>				
	<b>SH2WEB24</b>	<b>SB2WEB24</b>	<b>SH2MCG24</b>	<b>SH2WBU230</b>





# Dupline® Home and Building automation

	Bus generator	Network module	Communication module	Digital input module
<b>Function</b>	<b>DALI Master</b>	<b>Repeater</b>	<b>Mobile modem</b>	<b>4 inputs</b>
				
<b>Dimensions (mm)</b>	2 DIN module	2 DIN module	2 DIN module	2 DIN module
<b>Functions</b>	DALI Master and DALI Power supply	Repeater and isolator	Universal modem extension for Sx2WEB24	Input module, configurable as contact or pulse counter
<b>Electrical specifications</b>				
<b>Inputs</b>				4
<b>Outputs</b>				
<b>Power supply</b>	230 VAC	230 VAC	24 VDC ± 20%	24 VDC ± 20%
<b>General specifications</b>				
<b>LEDs</b>	Green, yellow, yellow	Green, yellow, yellow	Green, blue	Green, yellow, red
<b>Mounting</b>	DIN-rail (2 modules)	DIN-rail (2 modules)	DIN-rail (2 modules)	DIN-rail (2 modules)
<b>Degree of protection</b>	Front: IP 40, Screw terminal: IP 20	Front: IP 40, Screw terminal: IP 20	Front: IP 40, Screw terminal: IP 20	Front: IP 40, Screw terminal: IP 20
<b>Pollution degree</b>	2 (IEC 60664-1, par. 4.6.2)	2 (IEC 60664-1, par. 4.6.2)	2 (IEC 60664-1, par. 4.6.2)	2 (IEC 60664-1, par. 4.6.2)
<b>Operating temperature</b>	-20°C to +50°C	0°C to +50°C	-20°C to +50°C	-20°C to +50°C
<b>Storage temperature</b>	-40°C to +70°C	-50°C to +85°C	-30°C to +70°C	-50°C to +85°C
<b>Humidity (non condensing)</b>	20-80 %	20-90 %	90% @ 40°C	20 to 80 %
<b>Main features</b>	Acts as a gateway between Smart Dupline® and DALI. Enables the use of DALI lighting actuators in the system	Extends the transmission distance by regenerating the carrier signal and providing 300 mA bus output. Acts as an isolator between primary and secondary Dupline®	Quad band: GSM, GPRS, EDGE Dual-band UMTS, GPRS, HSPA Available for Europe and USA	Voltage free, NPN, PNP, counter
<b>References</b>				
	<b>SB2DALI230</b>	<b>SB2REP230</b>	<b>SH2UMMF124</b>	<b>SH2INDI424</b>



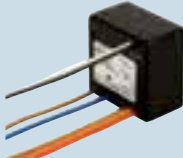

## Dupline® Home and Building automation

	Output modules		Relay modules	
Output type	Solid state relay	SPST relay	Bistable relay	Bistable relay
				
Dimensions (mm)	2 DIN module	2 DIN module	2 DIN module	2 DIN module
Functions	Four-solid-state relay output module	Four-relay output module	Four-relay output module	Two-relay output module with energy measurement
<b>Electrical specifications</b>				
Outputs	4	4	4	2
Power supply	24 VDC ± 20%	24 VDC	Bus	230 VAC
<b>General specifications</b>				
LEDs	Green, yellow, red	Green, yellow, red	Green, yellow, red	Green, yellow, red
Mounting	DIN-rail (2 modules)	DIN-rail (2 modules)	DIN-rail (2 modules)	DIN-rail (2 modules)
Degree of protection	Front: IP 40, Screw terminal: IP 20	Front: IP 40, Screw terminal: IP 20	Front: IP 40, Screw terminal: IP 20	Front: IP 40, Screw terminal: IP 20
Pollution degree	2 (IEC 60664-1, par. 4.6.2)	2 (IEC 60664-1, par. 4.6.2)	2 (IEC 60664-1, par. 4.6.2)	2 (IEC 60664-1, par. 4.6.2)
Operating temperature	-20°C to +50°C	-20°C to +50°C	-20°C to +50°C	-20°C to +50°C
Storage temperature	-50°C to +85°C	-50°C to +85°C	-50°C to +85°C	-50°C to +85°C
Humidity (non condensing)	20 to 80 %	20 to 80 %	20 to 80 %	20 to 80 %
Main features	Load: 10 W x 4 Local bus	Load: 5 A, voltage free x 4 Local bus	Load: 16 A, 230 VAC x 4 Local bus	Load: 16 A, 230 VAC x 2 Energy reading, Local bus
<b>References</b>				
	<b>SH2SSTRI424</b>	<b>SH2RE1A424</b>	<b>SH2RE16A4</b>	<b>SH2RE16A2E230</b>

# Dupline® Home and Building automation





Output type	Relay modules		Roller blind modules	
	Bistable relay	Bistable relay	SPST relay	SPST relay
				
Dimensions (mm)	50 x 30 x 18	26 x 39 x 17	50 x 50 x 30	2 DIN module
Functions	Wireless relay output module with energy measurement	Small sized remote relay output	Decentralized module for up/down control of one rollerblind motor	Relay output module for up/down control of two AC rollerblind motors
<b>Electrical specifications</b>				
Outputs	1	1	1 SPST relay & 1 SPDT relay	2 SPST + 2 SPDT relay
Motor type			AC	AC
Power supply	230 VAC	Bus	230 VAC ± 15%	24 VDC ± 20%
<b>General specifications</b>				
LEDs	Green, blue			Green, yellow, red
Mounting	DIN-rail (2 modules)	Decentralized	Eurobox	DIN-rail (2 modules)
Degree of protection	Front: IP 40, Screw terminal: IP 20			Front: IP 40, Screw terminal: IP 20
Pollution degree	2 (IEC 60664-1, par. 4.6.2)	3 (IEC 60664)	3 (IEC 60664)	2 (IEC 60664-1, par. 4.6.2)
Operating temperature	-20°C to +50°C	-20°C to +50°C	-20°C to +50°C	-20°C to +50°C
Storage temperature	-50°C to +85°C	-50°C to +85°C	-50°C to +85°C	-50°C to +85°C
Humidity (non condensing)	20 to 80 %	20 to 80 %	20 to 80 %	20 to 80 %
Main features	Load: 16 A, 250 VAC, Energy reading, Wireless	Load: 13 A, 250 VAC	Up/down control, tilting, local bus	Up/down control, tilting, local bus
<b>References</b>				
	<b>SHDWRE16AE230</b>	<b>BDA-RE13A-U</b>	<b>SHDRODC230</b>	<b>SH2ROAC224</b>

## Dupline® Home and Building automation



	Roller blind modules	Dimmer modules		Transparent module
Output type	SPST relay	Power mosfet	1 to 10 V output	
				
Dimensions (mm)	2 DIN module	2 DIN module	2 DIN module	8.5 x 90 x 67
Functions	Relay output module for up/down control of two DC rollerblind motors	Power dimmer up to 500 W for R, L, C load and LED lamps	Analogue output dimmer for adjustable ballast with 1 to 10 V input	Transparent module for simplifying the wiring of the smart-house installation
<b>Electrical specifications</b>				
Outputs	2 SPST + 2 SPDT relay	1	4	
Motor type	DC			
Power supply	24 VDC ± 20%	230 VAC	24 VDC ± 20%	No power supply needed
<b>General specifications</b>				
LEDs	Green, yellow, red	Green, yellow, red	Green, yellow, red	
Mounting	DIN-rail (2 modules)	DIN-rail (2 modules)	DIN-rail (2 modules)	DIN-rail
Degree of protection	Front: IP 40, Screw terminal: IP 20	Front: IP 40, Screw terminal: IP 20	Front: IP 40, Screw terminal: IP 20	Front: IP 40 Screw terminal: IP 20
Pollution degree	2 (IEC 60664-1, par. 4.6.2)	2 (IEC 60664-1, par. 4.6.2)	2 (IEC 60664-1, par. 4.6.2)	2 (IEC 60664-1, par. 4.6.2)
Operating temperature	-20°C to +50°C	-20°C to +50°C	-20°C to +50°C	-20°C to +50°C
Storage temperature	-50°C to +85°C	-50°C to +85°C	-50°C to +85°C	-30°C to +70°C
Humidity (non condensing)	20 to 80 %	20 to 80 %	20 to 80 %	20 to 80 %
Main features	Up/down control, tilting, local bus	Local bus / Energy reading		
<b>References</b>				
			<b>SH2D10V424</b>	<b>SH1DUPFT</b>
With energy reading	<b>SH2RODC224</b>	<b>SH2D500WE230</b>		
Without energy reading		<b>SH2D500W1230</b>		





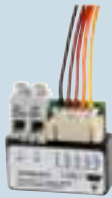

# Dupline® Home and Building automation

Analogue input modules				
Function	Input module	Input module	Input module	Input module
				
Dimensions (mm)	50 x 30 x 18	50 x 30 x 18	50 x 30 x 18	50 x 30 x 18
Functions	Input module with 3 analogue inputs	Input module with 4 analogue inputs	Input module with 2 analogue inputs	Input module with 2 analogue inputs
Electrical specifications				
Inputs	3 x 0-10 VDC	2 x 0-10 VDC, 1 x thermistor 10K3 input 1 x variable resistor 1-11 KΩ	1 x thermistor 10K3 1 x variable resistor 1-11 KΩ	2* Ni1000/Pt1000 inputs
Power supply	24 VDC	24 VDC	Bus	Bus
General specifications				
Mounting	Inside wall box or environmental sensor housings	Inside wall box or environmental sensor housings	Inside wall box or environmental sensor housings	Inside wall box or environmental sensor housings
Degree of protection	IP 20	IP 20	IP 20	IP 20
Pollution degree	2 (IEC 60664-1, par. 4.6.2)	2 (IEC 60664-1, par. 4.6.2)	2 (IEC 60664-1, par. 4.6.2)	2 (IEC 60664-1, par. 4.6.2)
Operating temperature	0°C to +50°C	0°C to +50°C	0°C to +50°C	0°C to +50°C
Storage temperature	-50°C to +85°C	-50°C to +85°C	-50°C to +85°C	-50°C to +85°C
Humidity (non condensing)	20 to 90 %	20 to 90 %	20 to 90 %	20 to 90 %
References				
	<b>SHPINV324</b>	<b>SHPINV2T1P124</b>	<b>SHPINT1P1</b>	<b>SHPINNI2</b>

# Dupline® Home and Building automation



	Analogue input modules		Analogue output modules
Function	Input module	Pulse counter	0 to 10 V output
			
Dimensions (mm)	50 x 30 x 18	28 x 14 x 10	50 x 30 x 18
Functions	Input module with 2 analogue inputs	Decentral 4 input pulse counter module	Output module with 2 analogue outputs
<b>Electrical specifications</b>			
Inputs	2 x 0-20 / 4-20 mA inputs		
Outputs	2 x 0-10 VDC		
Power supply	24 VDC	Powered by bus	24 VDC
<b>General specifications</b>			
Mounting	Inside wall box or environmental sensor housings	small sized plug-in	Inside wall box or environmental sensor housings
Degree of protection	IP 20	IP 20	IP 20
Pollution degree	2 (IEC 60664-1, par. 4.6.2)		2(IEC 60664-1, par. 4.6.2)
Operating temperature	0°C to +50°C	0°C to +50°C	0°C to +50°C
Storage temperature	-50°C to +85°C	-50°C to +70°C	-50°C to +85°C
Humidity (non condensing)	20 to 90 %	20 to 90%	20 to 90 %
<b>References</b>			
	<b>SHPINA224</b>		<b>SHPOUTV224</b>
SO inputs		<b>SHPINCNTS04</b>	
Contact inputs		<b>SHPINCNT4</b>	

# Dupline® Home and Building automation

Light Switch interfaces		Input modules		
Function	Input module	Input/output	Digital	Voltage
				
Dimensions (mm)	28 x 28 x 10	28 x 28 x 10	89 x 66 x 29	28 x 28 x 10
Functions	Input module for voltage free outputs	Input / output module for voltage free outputs and PNP transistor inputs	Input module for voltage free outputs or NPN transistor outputs.	Opto-isolated input voltage module, 90-265 VAC
<b>Electrical specifications</b>				
Inputs	4/8	4	4-contact or NPN transistor inputs	90 - 265 VAC
Outputs		4 PNP		
Power supply	Powered by bus	Powered by bus	Powered by bus	Powered by bus
<b>General specifications</b>				
LEDs			Green, yellow, red	
Mounting	In a junction box or behind a switch/pushbutton input	In a junction box or behind a switch/pushbutton input	DIN-rail mounting	
Degree of protection	IP 20	IP 20	IP 20	IP 20
Pollution degree				3 (IEC 60664)
Operating temperature	0°C to +50°C	0°C to +50°C	-20°C to +50°C	-20°C to +50°
Storage temperature	-20°C to +70°C	-20°C to +70°C	-50°C to +85°C	-50° to +70°C
Humidity (non condensing)	20 to 80%	20 to 80 %	20 to 80%	20 to 80%
<b>References</b>				
			<b>BDD-INCON4-U</b>	<b>BDA-INVOL-U</b>
4 contacts	<b>BDB-INCON4-U</b>			
8 contacts	<b>BDB-INCON8-U</b>			
Output voltage 3.3 V		<b>BDB-IOCP8-U</b>		
Output voltage 8 V		<b>BDB-IOCP8A-U</b>		

# Dupline® Home and Building automation

## Glass Switches

Function	Switch	Dimming	Temperature
			
Dimensions (mm)	120 x 80 x 27.2, 80 x 80 x 27.9	120 x 80 x 27.2, 80 x 80 x 27.9	120 x 80 x 27.2, 80 x 80 x 27.9
Functions	Programmable glass touch switch	Programmable glass touch switch for dimming control	Programmable glass touch switch for temperature control

### Electrical specifications

Number of switches	4/6	4	4
Power supply	24 VDC	24 VDC	24 VDC

### General specifications



Colour	Black/white	Black/white	Black/white
LEDs	Blue/white	Blue/white	Blue/white
Mounting	Ø60 box, 503 box	Ø60 box, 503 box	Ø60 box, 503 box
Degree of protection	IP 20	IP 20	IP 20
Pollution degree	3 (IEC 60664)	3 (IEC 60664)	3 (IEC 60664)
Operating temperature	-10°C to +50°C	-10°C to +50°C	-10°C to +50°C
Storage temperature	-20°C to +70°C	-20°C to +70°C	-20°C to +70°C
Humidity (non condensing)	20 to 80%	20 to 80%	20 to 80%
Remarks	Approved according to UL60950, integrated temperature probe	Approved according to UL60950	Approved according to UL60950, integrated temperature probe

### References

4 push buttons, Ø60 box	<b>SHG060WLS4, SHG060BLS4</b>		
6 push buttons, 503 box	<b>SHG503WLS6, SHG503BLS6</b>		
display for dimming, Ø60 box		<b>SHG060WSLD, SHG060BSLD</b>	
display for dimming, 503 box		<b>SHG503WSLD, SHG503SLD</b>	
temperature display, Ø60 box			<b>SHG060WSLT, SHG060BSLT</b>
temperature display, 503 box			<b>SHG503WSLT, SHG503BSLT</b>

# Dupline® Home and Building automation

## Light Switches

Function	4 pushbutton	4 pushbutton	4 pushbutton + PIR + Luxmeter
			
Dimensions (mm)	44 x 44 / 55 x 55	44 x 44 / 55 x 55	44 x 44 / 55 x 55
Functions	Light switch for building automation applications	Wireless light switch for building automation applications	Light switch and PIR sensor for detecting presence and/or movement in indoor installations

### Electrical specifications

Number of switches	4	4	4
Power supply	Powered by bus	Supplied by battery, type Lithium button 2450 3V	Powered by bus

### General specifications



Colour	Black/white	Black/white	Black/white
LEDs	White/blue	Red/blue	White/blue
Mounting	Wallbox Btcino, Niko, Fuga / Elko, Gira, Jung	Wallbox Btcino, Niko, Fuga / Elko, Gira, Jung	Wallbox Btcino, Niko, Fuga / Elko, Gira, Jung
Degree of protection	IP 20	IP 20	IP 20
Pollution degree	3 (IEC 60664)	3 (IEC 60664)	3 (IEC 60664)
Operating temperature	-20°C to +50°C	-20°C to +50°C	0°C to +50°C
Storage temperature	-30°C to +60°C	-30°C to +60°C	-20°C to +70°C
Humidity (non condensing)	20 to 80%	20 to 80%	20 to 80%
Other functions			Operating distance: 8 m Angle: 90°
Remarks	Approved according to UL60950	Approved according to UL60950	Approved according to UL60950

### References

44 x 44 Wallbox Btcino, Niko, Fuga	<b>B4X-LS4-U</b>	<b>SHA4XWLS4</b>	<b>SHA4XLS4P90L</b>
55 x 55 Wallbox Elko, Gira, Jung	<b>B5X-LS4-U</b>	<b>SHE5XWLS4</b>	<b>SHE5XPLS4P90L</b>
44 x 44 Wallbox Btcino, Niko, Fuga Temperature and humidity	<b>SHA4XLS4TH</b>		
55 x 55 Wallbox Elko, Gira, Jung Temperature and humidity	<b>SHE5XLS4TH</b>		

# Dupline® Home and Building automation

## Movement / Presence sensors

Function	Temperature display	150° PIR /Luxmeter	90° PIR/Luxmeter
			
Dimensions (mm)	44 x 44 / 55 x 55	44 x 44 / 55 x 55	44 x 44 / 55 x 55
Functions	Temperature controller with display	PIR sensor for detecting presence and/or movement in indoor installations	PIR sensor for detecting presence and/or movement in indoor installations

### Electrical specifications

Number of switches	4		
Power supply	Powered by bus	Powered by bus	Powered by bus

### General specifications





Colour	White/black	White/black	White/black
LEDs	White/blue	White/blue	White/blue
Mounting	Wallbox Btcino, Niko, Fuga / Elko, Gira, Jung	Wallbox Btcino, Niko, Fuga / Elko, Gira, Jung	Wallbox Btcino, Niko, Fuga / Elko, Gira, Jung
Degree of protection	IP 20	IP 20	IP 20
Pollution degree	3 (IEC 60664)	3 (IEC 60664)	3 (IEC 60664)
Operating temperature	-10°C to +50°C	-20°C to +50°C	0°C to +50°C
Storage temperature	-20°C to +70°C	-30°C to +70°C	-20°C to +70°C
Humidity (non condensing)	20 to 80%	20 to 80%	20 to 80%
Remarks	Approved according to UL60950	Operating distance: 8 m angle:150°	Operating distance: 8 m Angle: 90°

### References

44 x 44 Wallbox Btcino, Niko, Fuga	<b>SHA4XTEMDIS</b>	<b>SHA4XP150/SHA4XP150L</b>	<b>B4X-PIR90-U</b>
55 x 55 Wallbox Elko, Gira, Jung	<b>SHE5XTEMDIS</b>	<b>SHE5XP150/SHE5XP150L</b>	<b>B5X-PIR90-U</b>
44 x 44 Wallbox Btcino, Niko, Fuga + luxmeter			<b>SHA4XP90L</b>
55 x 55 Wallbox Elko, Gira, Jung + luxmeter			<b>SHE4XP90L</b>

# Dupline® Home and Building automation

## Movement / Presence sensors

Function	90° PIR/ Luxmeter	90° PIR/ Luxmeter	90° PIR/ Luxmeter	360° PIR/ Luxmeter
				
Dimensions (mm)	104 x 55 x 57	Ø 76 x 25	67 x 52 x 34	Ø 90 x 40
Functions	PIR sensor for detecting presence and/or movement in indoor installations	PIR sensor for detecting presence and/or movement in indoor installations	PIR sensor for detecting presence and/or movement in indoor / outdoor installations	PIR sensor for detecting presence and/or movement in indoor installations with a built-in luxmeter

### Electrical specifications

Power supply	Powered by bus	Powered by bus	Powered by bus	Powered by bus
--------------	----------------	----------------	----------------	----------------





### General specifications

Colour	White	White	White	White
LEDs	Red	Blue	Red	Blue
Mounting	Wall mounting	LK ceilingbox PL52 or PL55	Wall mounting	Ceiling mounting
Degree of protection	IP 40	IP 20	IP 64 / IP 20	IP 20
Pollution degree	3 (IEC 60664)	3 (IEC 60664)	3 (IEC 60664)	3 (IEC 60664)
Operating temperature	0°C to +50°C	0°C to +50°C	-20°C to +50°C	0°C to +50°C
Storage temperature	-20°C to +70°C	-20°C to +70°C	-30°C to +70°C	-20°C to +70°C
Humidity (non condensing)	20 to 80%	20 to 80%	20 to 80%	20 to 80%
Main features	Operating distance: 12 m Angle: 90°	Operating distance: ≤ 8 m Angle: 90°	Operating distance: 0.5 - 15 m Angle: 90°	Operating distance: ≤ 7.5 m Angle: 360° Lens: dual detecting zones

### References





	<b>BSD-PIR90-U</b>	<b>BSB-PIR90-U</b>	<b>SHSQP360L</b>
Luxmeter	<b>SHSDP90L</b>	<b>SHSBP90L</b>	
Outdoor			<b>BSP-PIR90-U</b>
Indoor			<b>BSP-PIR90A-U</b>
Outdoor + luxmeter			<b>SHSPP90L</b>
Indoor + luxmeter			<b>SHSPP90LA</b>

# Dupline® Home and Building automation





	Touch displays		Environmental sensors	
Function	Graphical display	Display	RGB LED	Blind
				
Dimensions (mm)	187 x 147 / 147 x 107	80 x 90 x 26	80 x 90 x 26	80 x 90 x 26
Functions	High definition 7" and 4.3" colour touchscreens, BACnet, Modbus and KNX gateway	Room sensors for CO <sub>2</sub> , temperature and %RH measurement - with display	Room sensors for CO <sub>2</sub> , temperature and %RH measurement - with LED indication	Room sensors for CO <sub>2</sub> , temperature and %RH measurement
<b>Electrical specifications</b>				
Power supply	24 VDC ± 20%	Bus	Bus	Bus
<b>General specifications</b>				
Mounting	Wall mounting	Wall mounting	Wall mounting	Wall mounting
Indication	Display	Display	Red, green, blue	None
Degree of protection	Front: IP66 Rear: IP20	IP 20	IP 20	IP 20
Pollution degree		2 (IEC 60664-1, par. 4.6.2)	2 (IEC 60664-1, par. 4.6.2)	2 (IEC 60664-1, par. 4.6.2)
Operating temperature	0°C to +50°C	-20°C to +50°C	-20°C to +50°C	-20°C to +50°C
Storage temperature	-20°C to +70°C	-40°C to +70°C	-40°C to +70°C	-40°C to +70°C
Humidity (non condensing)	5 to 85% RH	0 to 90 %	0 to 90 %	0 to 90 %
Main features	Windows CE, 7", 800 x 480 pixel / 4.3", 480 x 272 pixel, Ethernet port, BACnet, Modbus, KNX, data logging, configurable graphical display and alarms management	CO <sub>2</sub> measuring range: 0 to 2000 ppm CO <sub>2</sub> measurement: Dual source infrared NDIR technology Temperature measuring range: -20°C to +50°C (-4 to 122°F) Humidity measuring range: 0 to 100 %RH	CO <sub>2</sub> measuring range: 0 to 2000 ppm CO <sub>2</sub> measurement: Dual source infrared NDIR technology Temperature measuring range: -20°C to +50°C (-4 to 122°F) Humidity measuring range: 0 to 100 %RH	CO <sub>2</sub> measuring range: 0 to 2000 ppm CO <sub>2</sub> measurement: Dual source infrared NDIR technology Temperature measuring range: -20°C to +50°C (-4 to 122°F) Humidity measuring range: 0 to 100 %RH
<b>References</b>				
7", 800 x 480 pixel	<b>BTM-T7-24</b>			
4.3", 480 x 272 pixel	<b>BTM-T4-24</b>			
Display, CO <sub>2</sub> + temperature	<b>SHSUCOTD</b>			
Display, CO <sub>2</sub> + temperature + humidity	<b>SHSUCOTH</b>			
Display, temperature + humidity	<b>SHSUTH</b>			
Display, temperature	<b>SHSUTD</b>			
RGB Led, CO <sub>2</sub> + temperature	<b>SHSUCOTL</b>			
RGB Led, temperature + humidity	<b>SHSUCOTHL</b>			
CO <sub>2</sub> + temperature	<b>SHSUCOT</b>			
CO <sub>2</sub> + temperature + humidity	<b>SHSUCOTH</b>			
Temperature + humidity	<b>SHSUTH</b>			
Temperature	<b>SHSUT</b>			







# Dupline® Home and Building automation

	Smoke	Water	Window	Alarm
Function	Smoke detector	Water sensor	Wireless sensor	Keypad
				
Dimensions (mm)	Ø 100 x 54 mm	70 x 39 x 15.5	sensor: 60 x 30 x 15.5 , magnet: 32 x 10.2 x 11.5	130 x 50 x 8
Functions	Smoke detector for home/ building applications	Water detection sensor for home/building applications	wireless, battery powered reed sensor with additional input	Programmable keypad for building access control and alarm control in indoor and outdoor applications
<b>Electrical specifications</b>				
Inputs			reed, voltage free	12 pushbuttons
Power supply	Powered by bus / 9 VDC battery	Powered by bus	battery	9-17 VDC
<b>General specifications</b>				
Colour	White	White	White	Black / white
LEDs	Red		Red/blue	Yellow, red, green, programmable
Mounting	Ceiling mounting	Wall mounting	Wall mounting, screw and double side tape	Wall box mounting
Degree of protection	IP 43	IP 67	IP20	IP 67
Pollution degree			2 (IEC 60664-1, par. 4.6.2)	
Operating temperature	0°C to +50°C	-20°C to +50°C	-20°C to +50°C	-15°C to +60°C
Storage temperature	-5°C to +85°C	-50°C to +85°C	-30°C to +85°C	-30° to 80°C
Humidity (non condensing)	20 to 80%	20 to 80 %	20 to 80 %	100%
Main features	Detection area: 60 m <sup>2</sup>	Input for Felson probe		28 user-programmable codes, Buzzer output
<b>References</b>				
		<b>BSF-WAT-U</b>		<b>BACC-KEYPAD-DC-U</b>
Battery backup	<b>BSG-SMOA-U</b>			
No battery backup	<b>BSG-SMO-U</b>			
reed contact			<b>SHDWWISEN</b>	
reed contact + voltage free			<b>SHDWWISENINI</b>	





## Dupline® Home and Building automation

	Enviromental sensor		Light	Temperature
Function	Weather station	Anemometer	Luxmeter	Outdoor
				
Dimensions (mm)	96 × 77 × 118	183 x 137 x 145	55 x 53 x 36	67 x 35 x 15
Functions	Weather station for measurement of temperature, wind speed, brightness and precipitation	Anemometer for building automation applications	Luxmeter for indoor / outdoor installations	Temperature sensor for indoor and outdoor applications
<b>Electrical specifications</b>				
Power supply	12 to 40 VDC / 12 to 28 VAC	Powered by bus	Powered by bus	Powered by bus
<b>General specifications</b>				
Colour	White		White	Light grey
Mounting	Wall mounting	Wall mounting	Wall mounting	Direct wall mounting
Connection				Cable / plug
Degree of protection	IP 44	IP 54	IP 44	IP 67
Pollution degree		2 (IEC 60664-1, par. 4.6.2)		
Operating temperature	-30°C to +50°	-20°C to +60°C	-30°C to +60°C	-40°C to +60°C
Storage temperature	-30°C to +70°C	-20°C to +60°C		-55°C to +85°C
Humidity (non condensing)	5 to 95%	20 to 80%		20 to 80%
Main features	GPS receiver	Measuring range: 2 to 25 m/s Heating system	Measuring range: 0 to 20 kLux	
Remarks				Approved according to UL60950
<b>References</b>				
	<b>SHOWEAGPS</b>	<b>BSN-ANE-U</b>	<b>BSH-LUX-U</b>	
Cable, 2 m				<b>BSI-TEMANAB-U</b>
Plug, M12				<b>BSI-TEMANA-U</b>





# Dupline® Parking guidance system

	Sensors	Carpark monitor	Passive indicators	Bus controlled indicators
<b>Types</b>	GP6220../GP6240..	GP3482 9091	GP6289..	GP6265..
				
<b>Dimensions (mm)</b>	Ø118 x 76	77 x 72 x 70	Ø118 x 76	Ø118 x 76
<b>Functions</b>	Ultrasonic sensors for detection of cars with or without LED indication	Configurable device for monitoring of free parking bays in an carpark	Passive indicator for sensor	3 coloured bus controlled indicator
<b>Housing type</b>	Direct mounting on ceiling	Mounting on DIN rail	Direct mounting on ceiling	Direct mounting on ceiling
<b>Electrical specifications</b>				
<b>Number of channels</b>	2 - 3	-	-	1 - 2
<b>Features/Signal types</b>	1 x signal for occupancy. 1 x signal for common calibration	Programmable device with builtin RS485 for displays. 120 sensors can be connected to the Monitor module	No programming. Only wire connected	Colours can be controlled via the Dupline® bus
<b>Power supply</b>	3-wire system with Dupline® and sensor supply	Dupline® 3-wire system with power for the L1 and L2 bus		3-wire system with Dupline® and LED supply
<b>General specifications</b>				
<b>Degree of protection</b>	IP 34	IP 20	IP 34	IP 34
<b>Operating temperature</b>	-40°C to +70°C	-40°C to +50°C	-40°C to +70°C	-40°C to +70°C
<b>Storage temperature</b>	-40°C to +85°C	-50°C to +85°C	-50°C to +85°C	-50°C to +85°C
<b>References</b>				
Red/Green LED	GP6220 2201		GP6289 0101	
Red/Blue LED	GP6220 2202		GP6289 0102	
Without LED	GP6240 2224			
Red/Green/Orange LED	GP6220 3301			GP6265 2301 GP6265 2301-1
Red/Green/Blue LED	GP6220 3302			GP6265 2302
Red/Blue/Orange LED	GP6220 3303			GP6265 2303
Red/Green LED US-version	GP6220 2201-US		GP6289 0101-US	
Red/Blue LED US-version	GP6220 2202-US		GP6289 0102-US	
Without LED US-version	GP6240 2224-US			
Red/Green/Orange LED US-version	GP6220 3301-US			GP6265 2301-US GP6265 2301-1-US
Red/Green/Blue LED US-version	GP6220 3302-US			GP6265 2302-US
Red/Blue/Orange LED US-version	GP6220 3303-US			GP6265 2303-US
Dupline® Carpark monitor		GP3482 9091 724		
Dupline® Carpark monitor for automatic booking systems		GP3482 9091 724-1		



# Dupline® Parking guidance system

	Carpark interface		Master Zone Counter	
Types	GP3496 0005	GP32900003	GP32900030	GPMZC-SET
				
Dimensions (mm)	77 x 72 x 70	35 x 90 x 63,5	35 x 90 x 63,5	105 x 90 x 63,5
Functions	Interface for Modbus-RTU with the function of a slave	Channel Generator function for L <sub>1</sub> or L <sub>2</sub>	Controller in the Dupline® zone counting system	Master Zone Counter up to 3840 places
Housing type	Mounting on DIN rail	Mounting on DIN rail	Mounting on DIN rail	Mounting on DIN rail
<b>Electrical specifications</b>				
Power supply	20-30 VDC 3-wire system	15-24 VDC ±20% 3-wire system	15-24 VDC ±20%	15-24 VDC ±20%
<b>Features</b>				
	RS232/RS422/RS485 port for making an interface to the control system. Multidropping of up to 16 devices on RS485	Channel Generator and power function for supplying the L <sub>1</sub> or the L <sub>2</sub> bus	Controller unit with webserver included. Ethernet port + 2 x RS485 ports	Complete zone count solution comprised of 1 x GP3290 0030 700 and 2 x GP3290 0003 700
<b>General specifications</b>				
Degree of protection	IP 20	IP 20	IP 20	IP 20
Operating temperature	-40°C to +50°C	-20°C to +50°C	-20°C to +50°C	-20°C to +50°C
Storage temperature	-50°C to +85°C	-30°C to +70°C	-30°C to +70°C	-30°C to +70°C
<b>References</b>				
Dupline® Master Module	<b>GP3496 0005 700</b>			
Dupline® Carpark Master Zone Counter				<b>GPMZC-SET</b>
Channel Generator with power on the 3 wire	<b>GP3290 0003 700</b>			
Carpark Controller with webserver	<b>GP3290 0030 700</b>			



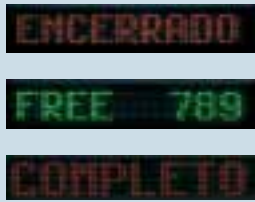

# Dupline® Parking guidance system

	Software	Displays		
Types	DUP-PGS-SWxx	GP67630106	GP67630107-08	GP67630109-11
				
Dimensions (mm)		145 x 145 x 60	145 x 240 x 60	145 x 335 x 60
Functions	A data logging, visualization and alarm handling software package to be installed in a windows based PC	Able to show green arrow, red cross or single digit	Able to show green arrow, red cross or single digit, together with disabled sign	3 character display with high flexibility to show digits, arrow, cross and disabled sign
Housing type		Aluminium box with plexiglass front	Aluminium box with plexiglass front	Aluminium box with plexiglass front
<b>Electrical specifications</b>				
Power supply		18-24 VDC / 15-25 W	18-24 VDC / 30-50 W	18-24 VDC / 40-60 W
<b>Features</b>				
	Client/server program that is developed to the GP34960005 Carpark Master Module together with Moxa RS485/ethernet connectors	Guides the driver by showing moving green arrow or red cross for a lane or area in the carpark	Guides the disabled driver by showing moving green arrow or red cross for a lane or area in the carpark	Guides the driver or disabled driver by showing moving green arrow or red cross as well as number of free spaces for a lane or area in the carpark
<b>General specifications</b>				
Degree of protection		IP 55	IP 55	IP 55
Pollution degree		3 (IEC 60664)	3 (IEC 60664)	3 (IEC 60664)
Operating temperature		-15°C to +50°C	-15°C to +50°C	-15°C to +50°C
Humidity		0 to 90% non condensing	0 to 90% non condensing	0 to 90% non condensing
<b>References</b>				
Dupline Carpark 250 parking spaces	<b>DUP-PGS-SW250</b>			
Dupline Carpark 500 parking spaces	<b>DUP-PGS-SW500</b>			
Dupline Carpark 1000 parking spaces	<b>DUP-PGS-SW1000</b>			
Dupline Carpark 2000 parking spaces	<b>DUP-PGS-SW2000</b>			
Dupline Carpark 3000 parking spaces	<b>DUP-PGS-SW3000</b>			
Dupline Carpark 4000 parking spaces	<b>DUP-PGS-SW4000</b>			
Dupline Carpark 5000 parking spaces	<b>DUP-PGS-SW5000</b>			
Dupline Carpark 6000 parking spaces	<b>DUP-PGS-SW6000</b>			
Dupline Carpark 7000 parking spaces	<b>DUP-PGS-SW7000</b>			
Dupline Carpark 8000 parking spaces	<b>DUP-PGS-SW8000</b>			
Dupline Carpark 9000 parking spaces	<b>DUP-PGS-SW9000</b>			
Dupline Carpark 10000 parking spaces	<b>DUP-PGS-SW10000</b>			
1 segment display		<b>GP67630106</b>		
2 segment display			<b>GP67630107</b>	
			<b>GP67630108</b>	
3 segment display				<b>GP67630109</b>
				<b>GP67630110</b>
				<b>GP67630111</b>





# Dupline® Parking guidance system

Displays			
Types	GP67630116	GP6763 0112 - 14	GP6763 0115
			
Dimensions (mm)	145 x 430 x 60	145 x 910 x 60 (113+114) 145 x 815 x 60 (112)	210 x 1170 x 60
Functions	4 character display with high flexibility to show digits, arrow and cross	8 character display. 113+114 has also disabled, red cross or green arrow function	9 character display. 113+114 has also disabled, red cross or green arrow function
Housing type	Aluminium box with plexiglass front	Aluminium box with plexiglass front	Aluminium box with plexiglass front
Electrical specifications			
Power supply	18-24 VDC / 60-100 W	18 - 24 VDC 35-50 W power consumption	18 - 24 VDC Typical 35 W power consumption
Features			
	Guides the driver by showing moving green arrow or red cross as well as number of free spaces for a lane or area in the carpark	Show a text on max. 8 character. The text is of costumers own choise. RS 485 communication	Show a text on max. 9 character. The text is of costumers own choise. RS 485 communication
General specifications			
Degree of protection	IP 55	IP 55	IP 55
Pollution degree	3 (IEC 60664)	3 (IEC 60664)	3 (IEC 60664)
Operating temperature	-15°C to +50°C	-15°C to +50°C	-15°C to +50°C
Humidity	0 to 90% non condensing	0 to 90% non condensing	0 to 90% non condensing
References			
4 segment display	<b>GP6763 0116</b>		
		<b>GP6763 0112</b>	
8 segment display		<b>GP6763 0113</b>	
		<b>GP6763 0114</b>	
9 segment display			<b>GP6763 0115</b>

# Dupline® DuplineSafe

	Input module	Output module	Gateway / interface	
<b>Types</b>	<b>GS7510 2101</b>	<b>GS3830 0143</b>	<b>GS3891 0125</b>	<b>GSTI 50</b>
				
<b>Dimensions (mm)</b>	57.5 x 36.0 x 16.4	144 x 77 x 70	144 x 77 x 70	55 x 70 x 15
<b>Functions</b>	Bus-powered safety input module	DuplineSafe relay output module. Monitors up to 63 DuplineSafe inputs	Profibus-DP Gateway passive with Safety mapping	Dupline® Modbus interface module with Safety mapping
<b>Housing type</b>		DIN-rail mounting H8	DIN-rail mounting H8	Compact plastic housing
<b>Electrical specifications</b>				
<b>Number of channels</b>	2	2		
<b>Features/Signal types</b>	1 x NC contact	2 x NO Relays Force Guided contact	Reads/controls up to 128 inputs/outputs through Profibus-DP, Communication speed up to 12 MBaud	
<b>Power supply</b>	Powered through the Dupline® network	230 VAC ± 15%	115 = 115 VAC 230 = 230 VAC	Powered by the RS485 com port
<b>General specifications</b>				
<b>Degree of protection</b>	IP 67	IP 20	IP 20	IP 20
<b>Pollution degree</b>	3 (IEC 60664)	3 (IEC 60664)		
<b>Operating temperature</b>	-40°C to +50°C	-25°C to +50°C	0°C to +50°C	-20°C to +60°C
<b>Storage temperature</b>	-40°C to +70°C	-30°C to +70°C	-20°C to +85°C	-30°C to +85°C
<b>Humidity (non condensing)</b>	20 to 80%	20 to 80%	20 to 80%	
<b>Remarks</b>	Approved according to IEC/EN 61508, EN 62061 and ISO/EN 13849-1 PL e	Approved according to IEC/EN 61508, EN 62061 and ISO/EN 13849-1 PL e	Certified by PNO	Supports Modbus RTU function code 3 and code 16
<b>References</b>				
<b>Cable connection</b>	<b>GS7510 2101</b>			
<b>Cable connection cULus approved</b>	<b>GS7510 2192</b>			
<b>Plug connector</b>	<b>GS7510 2101-1</b>			
<b>Plug connector cULus approved</b>	<b>GS7510 2192-1</b>			
<b>Output relay</b>	<b>GS3830 0143</b>			
<b>Gateway / interface</b>			<b>GS3891 0125</b>	<b>GSTI 50</b>



# Dupline® DuplineSafe

	Optical fibre converter	Repeater	Configuration tool	
Types	GS3492/GS3493	GS3892 0000	GS7380 0080	GS7380 0081
				
Dimensions (mm)	77 x 72 x 70	77 x 144 x 70	28 x 90 x 145	25 x 50 x 100
Functions	Optical repeater for converting DuplineSafe from electrical to optical transmission media	DuplineSafe signal repeater for extension of transmission distance	Configuration and test unit for DuplineSafe	USB Configuration unit for DuplineSafe
Housing type	DIN-Rail, H4	DIN-Rail H8	Handheld	Handheld
<b>Electrical specifications</b>				
Number of channels	Adjusts automatically	Adjusts automatically		
Features/Signal types	All Dupline® signal types	Regenerates the Dupline® signal carrier through channel generator output		Windows based programming tool for safety output relay module and safety input modules
Power supply	230 = 115/230 VAC	024 = 024 VAC 115 = 115 VAC 230 = 230 VAC	9 V battery 6LR61	Supplied by the USB port
<b>General specifications</b>				
Degree of protection	IP 20	IP 40	IP 40	IP 40
Pollution degree				3 (IEC 60664)
Operating temperature	0°C to +50°C	0°C to +50°C	-10°C to +45°C	0°C to +50°C
Storage temperature	-20°C to +85°C	-50°C to +85°C	-20°C to +70°C	-20°C to +60°C
Humidity (non condensing)				
Remarks	Operates pair-wise. Runs on 50/125, 62.5/125 or 100/140 micro m with STN connectors		Adapt 7380 is included	
<b>References</b>				
		<b>GS3892 0000</b>	<b>GS7380 0080</b>	<b>GS7380 0081</b>
Optical/electrical converter	<b>GS3492 0000</b>			
Electrical/optical converter	<b>GS3493 0000</b>			



# Dupline® Industrial

## Channel generators/interfaces

Types	G3490	G3496	G3800
			
Dimensions (mm)	77 x 72 x 70	77 x 72 x 70	77 x 144 x 70
Functions	Standard channel generator	Plug & Play RS232/RS485 Interface with built-in protocols for specific PLC brands and Modbus	Controller and Modbus Interface with built-in GSM Modem (option) or external Radio Modem Logger (option)
Housing type	DIN-Rail, H4	DIN-Rail, H4	DIN-Rail, H8
<b>Electrical specifications</b>			
Number of channels	Selectable	Selectable	Selectable
Features/Signal types		Possibility for 3-wire operation with DC-power on the 3 <sup>rd</sup> wire	4 x Contact/PNP input +4 x PNP 10-30 VDC output 2 x RS232+1 x RS485. Possibility for alarms, monitoring and control via SMS messages
Power supply	024 = 24 VAC 115 = 115 VAC 230 = 230 VAC 824 = 15-30 VDC	700 = 20-30 VDC	800 = 10-30 VDC 230 = 115-230 VAC
<b>General specifications</b>			
Degree of protection	IP 20	IP 20	IP 20
Operating temperature	-20°C to +50°C	0°C to +50°C	0°C to +50°C
Storage temperature	-50°C to +85°C	-50°C to +85°C	-20°C to +85°C
Remarks		Built-in protocol for specific PLC brands for easy interfacing	Up to 32 controllers can be networked together via RS485 or Ethernet via converter module
<b>References</b>			
Channel Generator	<b>G3490 0000</b>		
Optolink	<b>G3496 0000</b>		
LG	<b>G3496 0001</b>		
GE-Fanuc	<b>G3496 0002</b>		
Mitsubishi	<b>G3496 0003</b>		
Omron	<b>G3496 0004</b>		
Modbus	<b>G3496 0005</b>		
Allen-Bradley	<b>G3496 0006</b>		
Schneider	<b>G3496 0007</b>		
Koyo	<b>G3496 0008</b>		
Matsushita	<b>G3496 0009</b>		
Siemens	<b>G3496 0010</b>		
Toshiba	<b>G3496 0011</b>		
IDEC	<b>G3496 0012</b>		
-GSM Modem, -RS485			<b>G3800 0015</b>
+GSM Modem, -RS485			<b>G3800 1015</b>
-GSM Modem, +RS485			<b>G3800 0016</b>
+GSM Modem, +RS485			<b>G3800 1016</b>
-GSM Modem, +RS485, +Logging			<b>G3800 0036</b>
+GSM Modem, +RS485, +Logging			<b>G3800 1036</b>

# Dupline® Industrial

	Channel generators/interfaces		Digital input modules	
Types	G3891	GTI50	G3410 5501	G3420
				

Dimensions (mm)	77 x 144 x 70	55 x 70 x 15 mm	77 x 72 x 70	77 x 72 x 70
Functions	Gateways to Fieldbus systems (Profibus-DP, DeviceNet etc.)	Dupline® Modbus RTU Interface module for Text Displays and Touch screens	Dupline® powered transmitter with 8 monostable volt-free contacts	Input module for external supply with optoisolated inputs
Housing type	DIN-Rail, H8	Closed plastic housing with 25p male sub-D	DIN-Rail, H4	DIN-Rail, H4

## Electrical specifications

Number of channels	Selectable		8	8
Features/Signal types		Supports Modbus RTU function code 3 and code 16	Volt-free input contacts	Contact/NPN Voltage (6-265 VAC/DC)
Power supply	230 = 115/230 VAC	Powered by RS485 port	Powered by Dupline®	024 = 24 VAC 115 = 115 VAC 230 = 230 VAC 800 = 10-30 VDC

## General specifications





Degree of protection	IP 20	IP 20	IP 20	IP 20
Operating temperature	0°C to +50°C	-20°C to +60°C	-20°C to +50°C	-20°C to +50°C
Storage temperature	-20°C to +85°C	-50°C to +85°C	-50°C to +85°C	-50°C to +85°C
Remarks			Low power consumption	

## References





GTI50	
Profibus-DP with C. G.	<b>G3891 0020</b>
Profibus-DP analogue output multiplex	<b>G3891 0021</b>
DeviceNet	<b>G3891 0050</b>
Lonworks	<b>G3891 0051</b>
Modbus / TCP	<b>G3891 0052</b>
Profibus-DP passive	<b>G3891 0120</b>
8 channel	<b>G3410 5501</b>
Contact/NPN	<b>G3420 5501</b>
Voltage	<b>G3420 5502</b>

# Dupline® Industrial





## Digital input modules

Types	G4420 7401	G5010	G6391 0240	G8810 2201
				
Dimensions (mm)	36 x 85 x 58	49 x 22.5 x 56	34.2 x 37.5 x 36.8	28 x 14 x 10
Functions	Input module for counting of pulses from energy meters, item detectors etc	Dupline powered single input Module	Plug-in module to EM4 or WM22 with 2 SO input contacts for measuring water, gas etc	Small-sized 2-channel monostable transmitter
Housing type	DIN-Rail, H2	DIN-Rail, Mini-E	Plug-in	Plug-in
<b>Electrical specifications</b>				
Number of channels	4	1	2	2
Features/Signal types	Contact input (DIN 43 864). Max. count frequency: 14 Hz	Contact input	Reads actual internal value of total energy and/or reactive energy from EM4/WM22 and transmits to Dupline®. 2 x SO contact input	2 contact inputs for push buttons
Power supply	230 = 230 VAC 724 = 15-30 VDC	Powered through the Dupline® network	Powered through the Dupline® network and EM4/WM22	Supplied by Dupline®
<b>General specifications</b>				
Degree of protection	IP 40	IP 20	IP 20	IP 65
Operating temperature	-20°C to +60°C	-20°C to +50°C	0°C to +50°C	-40°C to +70°C
Storage temperature	-20°C to +85°C	-50°C to +85°C	-20°C to +85°C	-40°C to +70°C
Remarks	Decentral counting. Counter values stored in non-volatile memory			Address coding by GAP 1605
<b>References</b>				
4 channel Counter	<b>G4420 7401</b>			
1 channel		<b>G5010 1106</b>		
2 channels		<b>G5010 2206</b>		<b>G8810 2201</b>
2 channel plug-in module			<b>G6391 0240</b>	





# Dupline® Industrial



	Digital I/O modules		Digital output modules	
Types	G3440 4443	G3440 5543	G3430 / G3830	G34305545
				
Dimensions (mm)	77 x 72 x 70	77 x 72 x 70	77 x 72 x 70 77 x 144 x 70 (H8)	77 x 72 x 70
Functions	Combined I/O module for external supply with optoisolated inputs and relay outputs	I/O module for digital signals	Output modules for external supply with isolated outputs	Central relay module with 8 x SPST relays for resistive loads
Housing type	DIN-Rail, H4	DIN-Rail, H4	DIN-Rail, H4 DIN-Rail, H8 (G3830 5543)	DIN-Rail, H4
<b>Electrical specifications</b>				
Number of channels	4	6	1, 2, 4, 8	8
Features/Signal types	2 x 6-265 VAC/DC inputs + 2 x SPST relay outputs	4 opto isolated inputs and 2 SPST relay outputs	10 A SPDT relay 5 A SPST relay 0.7 A NPN transistor 0.7 A PNP transistor	8 x 16 A/250 VAC relays Inrush current: <130 A
Power supply	024 = 24 VAC 115 = 115 VAC 230 = 230 VAC 824 = 15-30 VDC	230 = 230 VAC	024 = 24 VAC 115 = 115 VAC 230 = 230 VAC 800 = 10-30 VDC 824 = 15-30 VDC	024 = 24 VAC 115 = 115 VAC 230 = 230 VAC
<b>General specifications</b>				
Degree of protection	IP 20	IP 20	IP 20	IP 20
Operating temperature	-20°C to +50°C	-20°C to +50°C	-20°C to +50°C	-5°C to +50°C
Storage temperature	-50°C to +85°C	-50°C to +85°C	-50°C to +85°C	-50°C to +85°C
Remarks				Total module load max. 32 A
<b>References</b>				
2 input + 2 output SPST	<b>G3440 4443</b>			
4 input + 2 output SPST		<b>G3440 5543</b>		
1 x 10 A SPDT			<b>G3430 1149</b>	
2 x 10 A SPDT			<b>G3430 2249</b>	
4 x 5 A SPST			<b>G3430 4443</b>	
4 x 16 A SPST			<b>G3430 4445</b>	
8 x 5 A SPST			<b>G3830 5543</b>	
8 x 0.7 A NPN			<b>G3430 5511</b>	
8 x 0.7 A PNP			<b>G3430 5521</b>	
8 x 16 A SPST (Max. 32 A)				<b>G3430 5545</b>

# Dupline® Industrial

	Digital output modules	Analogue input modules		
Types	G8830 1143	G3429 6470	G3210 1161	G3210 1111
				
Dimensions (mm)	26 x 39 x 17	77 x 72 x 70	77 x 36 x 70	77 x 36 x 70
Functions	Decentral relay module with 1 x SPST relay for control of lights	Universal analogue input module for external supply	Analogue input module powered from Dupline® and input signal	Dupline®- powered Analogue input module for Pt100 temperature sensor
Housing type	Compact regular, with solid cables. For decentral installation	DIN-Rail, H4	DIN-Rail, H2	DIN-Rail, H2
<b>Electrical specifications</b>				
Number of channels	1	Selectable	1	1
Features/Signal types	1 x 13 A/250 VAC relay Inrush current: <130 A	4 x isolated analogue input. Input type individually configurable (0-20 mA, 4-20 mA, 0-10 VDC)	1 x 4-20 mA input	1 x Pt100 3-wire input Ranges: (-50°C to +40°C) (+30°C to +120°C) (-10°C to +100°C)
Power supply	Powered through the Dupline® network	024 = 24 VAC 115 = 115 VAC 230 = 230 VAC 800 = 10-30 VDC	Powered through the Dupline® network and 4-20 mA input signal	Powered through the Dupline® network
<b>General specifications</b>				
Degree of protection	IP 20	IP 20	IP 20	IP 20
Operating temperature	0°C to +50°C	0°C to +50°C	0°C to +50°C	0°C to +50°C
Storage temperature	-50°C to +85°C	-20°C to +85°C	-50°C to +85°C	-50°C to +85°C
Remarks	Recommended minimum load 100 mA / 12 V	Protocol freely selectable (Analink, Multiplexed BCD or 8-bit)	Uses Analink 8-bit protocol	Uses Analink 8-bit protocol. Built-in cable compensation
<b>References</b>				
Universal analogue output	<b>G3429 6470</b>			
Dupline powered analogue input	<b>G3210 1161</b>			
-50°C to +40°C	<b>G3210 1111</b>			
+30°C to +120°C	<b>G3210 1112</b>			
-10°C to +100°C	<b>G3210 1113</b>			
1 x 13 A SPST	<b>G8830 1143</b>			

# Dupline® Industrial

	Analogue output modules	Decentral analogue input modules		
Types	G3439 6470	G8810 6265	G8810 6311	G8810 6312
				
Dimensions (mm)	77 x 72 x 70	50 X 30 X 18	50 X 30 X 18	50 X 30 X 18
Functions	Universal analogue output module for external supply	Decentral analogue module with 3 x 0-10 VDC inputs designed for HVAC systems	Decentral analogue module with 2 x 0-10 VDC, 1 x thermistor and 1 x variable resistor inputs designed for HVAC systems	Decentral analogue module with 1 x thermistor and 1 x variable resistor inputs designed for HVAC systems
Housing type	DIN-Rail, H4	Compact housing for decentral installation	Compact housing for decentral installation	Compact housing for decentral installation
<b>Electrical specifications</b>				
Number of channels	Selectable	3	4	2
Features/Signal types	4 x analogue outputs. Output type configurable for 0-20 mA, 4-20 mA or 0-10 VDC	3 x 0-10 VDC input	2 x 0-10 VDC input 1 x thermistor 10k3 input 1 x variable resistor 1 - 11 KΩ input	1 x thermistor 10k3 input 1 x variable resistor 1 - 11 KΩ input
Power supply	024 = 24 VAC 115 = 115 VAC 230 = 230 VAC 800 = 10-30 VDC	Powered from external 15 - 30 VDC	Powered from external 15 - 30 VDC	Dupline® powered
<b>General specifications</b>				
Degree of protection	IP 20	IP 20	IP 20	IP 20
Operating temperature	0°C to +50°C	0°C to +50°C	0°C to +50°C	0°C to +50°C
Storage temperature	-20°C to +85°C	-20°C to +85°C	-20°C to +85°C	-20°C to +85°C
Remarks	Protocol freely selectable (Analink, Multiplexed BCD or 8-bit)	Analink protocol 8 bit resolution	Analink protocol 8 bit resolution	Analink protocol 8 bit resolution
<b>References</b>				
Universal analogue output	<b>G3439 6470</b>			
Decentral 3 x input		<b>G8810 6265</b>		
Decentral 4 x input			<b>G8810 6311</b>	
Decentral 2 x input Bus powered				<b>G8810 6312</b>



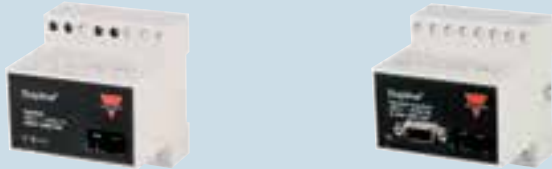

<b>Dupline® Industrial</b>			
	<b>Digital sensors</b>		<b>Temperature Sensor</b>
<b>Types</b>	<b>G6110 1145</b>	<b>G8910 1101</b>	<b>G8911 1010</b>
			
<b>Dimensions (mm)</b>	M18 x 55	Ø11 x 68	67 x 35 x 15
<b>Functions</b>	Dupline® powered inductive proximity switch	Dupline® powered magnet proximity switch	Temperature sensor for outdoor use. With built-in PT1000 transducer
<b>Housing type</b>	M18	Cylindrical	Flat pack sensor housing
<b>Electrical specifications</b>			
<b>Number of channels</b>	1	1	1
<b>Features/Signal types</b>	Detects proximity of metal objects	Detects proximity of magnet	1 x Analink Range: -30°C to +60°C
<b>Power supply</b>	Powered through the Dupline® network	Powered through the Dupline® network	Powered through the Dupline® network
<b>General specifications</b>			
<b>Degree of protection</b>	IP 67	IP 67	IP 67
<b>Operating temperature</b>	-25°C to +70°C	-20°C to +50°C	-25°C to +70°C
<b>Storage temperature</b>	-30°C to +80°C	-20°C to +70°C	-55°C to +85°C
<b>Remarks</b>	Available with cable or M12 connector. Flush mounting	Available in Ø 11 plastic housing or with M14 metal thread	8-bit resolution
<b>References</b>			
<b>Cable</b>	<b>G6110 1145</b>		
<b>M12 plug</b>	<b>G6110 1145-1</b>		<b>G8911 1010</b>
<b>Ø11</b>		<b>G8910 1101</b>	
<b>M14</b>		<b>G8910 1101-G</b>	

# Dupline® Industrial



Types	Repeater		Optolink interface	
Housing	D3892 0000	G3491 0000	G3491 0090	
				
Dimensions (mm)	77 x 144 x 70	77 x 72 x 70	77 x 72 x 70	
Functions	Dupline® signal Repeater for extension of transmission distance	RS232 to fibre optic interface	RS232 to fibre opto-link interface	
Housing type	DIN-Rail, H8	DIN-Rail, H4	DIN-Rail, H4	
<b>Electrical specifications</b>				
Number of channels	Adjusts automatically	Adjusts automatically	Adjusts automatically	
Features/Signal types	All Dupline® signal types. Regenerates the Dupline® signal carrier through channel-generator output	Reads/controls up to 63 Dupline® systems which are networked through optolinks (G3491 0000)	Used as interface between computer or PLC with RS232 and a fibre optic Lan-ring	
Power supply	024 = 24 VAC 115 = 115 VAC 230 = 230 VAC	024 = 24 VAC 115 = 115 VAC 230 = 230 VAC	024 = 24 VAC 115 = 115 VAC 230 = 230 VAC	
<b>General specifications</b>				
Degree of protection	IP 20	IP 20	IP 20	
Operating temperature	0°C to +50°C	0°C to +50°C	0°C to +50°C	
Storage temperature	-50°C to +85°C	-50°C to +85°C	-20°C to +85°C	
Remarks		Operates with G3491 0090	Operates with G3491 0000	
<b>References</b>				
Repeater (Booster)	<b>D3892 0000</b>			
Dupline® fibre interface	<b>G3491 0000</b>			
RS232 to optolink interface	<b>G3491 0090</b>			



# Dupline® Industrial

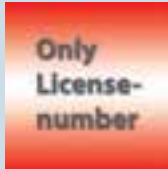

	Converters		Display modules	Power supply
Types	G3491 0040	G3492 / G3493	G5460 6606	G3485 0000
				
Dimensions (mm)	77 x 72 x 70	77 x 72 x 70	96 x 96 x 78	77 x 72 x 70
Functions	Private line Modem for long distance transmission of Dupline® signals	Optical repeater for converting Dupline® from electrical to optical transmission media	LED status indicator for 16 Dupline® channels	3-wire power supply, used when multiple Dupline® modules are supplied through a DCbus
Housing type	DIN-Rail, H4	DIN-Rail, H4	Panel mounting	DIN-Rail, H4
<b>Electrical specifications</b>				
Number of channels	Adjusts automatically	Adjusts automatically	16	Selectable
Features/Signal types	Digital, 8-bit analogue, non-multiplexed 3 1/2 digit BCD analogue	All Dupline® signal types	Each of the 16 LED's indicates the status of the digital channels assigned to it	Supply current ≤ 4 A (up to 25°C) or ≥ 3 A (up to 50°C)
Power supply	024 = 24 VAC 115 = 115 VAC 230 = 230 VAC	230 = 115/230 VAC	024 = 24 VAC 115 = 115 VAC 230 = 230 VAC	15-30 VDC
<b>General specifications</b>				
Degree of protection	IP 20	IP 20	IP 40	IP 20
Operating temperature	0°C to +50°C	0°C to +50°C	0°C to +50°C	-5°C to +50°C
Storage temperature	-20°C to +85°C	-20°C to +85°C	-20°C to +60°C	-20°C to +85°C
Remarks	Operates pair-wise	Operates pair-wise. Runs on 0/125, 62.5/125 or 100/140 micro m with STN connectors		Multiple units can be connected in parallel to increase length and size of a Dupline® system
<b>References</b>				
Long distance modem	<b>G3491 0040</b>			
Optical/electrical converter	<b>G3492 0000</b>			
Electrical/optical converter	<b>G3493 0000</b>			
LED indicator for Dupline	<b>G5460 6606</b>			
3-wire power supply	<b>G3485 0000 700</b>			

# Dupline® Industrial

Software			
Types	DUPDATAACC	DUP-SERV-ADD	DUP-SERV-SW
			
Functions	Software package with DDE-driver and ActiveXdriver for G3800. Controller and interface unit	A data logging, visualization and alarm handling software package to be installed in a windows based PC	A data logging, visualization and alarm handling software package to be installed in a windows based PC
<b>Features</b>			
	All Dupline® signal types. Copy and paste of dynamic Dupline links into EXCEL spreadsheets	Works only with G3800 xx36. Log and control energy consumption, analogue values and digital events and alarms	Works only with G3800 xx36. Log and control energy consumption, analogue values and digital events and alarms
<b>References</b>			
DDE-Server	<b>DUPDATAACC</b>		
Dupline-Online One License			<b>DUP-SERV-SW</b>
ADD-License to Dupline-Online		<b>DUP-SERV-ADD</b>	
Dupline-Online two license			<b>DUP-SERV-SW2</b>





# Dupline® Industrial

## Accessories

Types	GAP1605	GTU8	G3282 2002 230
			
Dimensions (mm)	120 x 65 x 22	145 x 90 x 28	77 x 36 x 70
Functions	Dupline® coding device for assigning addresses to Dupline® I/O modules and sensors	Dupline® test unit for monitoring and control of Dupline® channels	Dupline® bus separator
Housing type	Handheld	Handheld	H2 Housing
<b>Electrical specifications</b>			
Number of channels	NA	Adjusts automatically	2
Features/Signal types		Digital, multiplexed BCD, 8-bit analogue signals and split I/O. Also prepared to calibrate sensors in Carpark system	Disconnect the secondary side of the Dupline® bus when a short-circuit is detected
Power supply	9 V battery	Powered through the Dupline® network	230 V
<b>General specifications</b>			
Degree of protection	IP 40	IP 40	IP 20
Operating temperature	0°C to +50°C	0°C to +50°C	0°C to +50°C
Storage temperature	-20°C to +60°C	-20°C to +85°C	-20°C to +85°C
Remarks		Options for latching digital signals and for reading multiplexed BCD values	
<b>References</b>			
Programmer	GAP1605		
Display			
Monitoring and control unit	GTU8		
Bus separator	G3282 2002 230		





# Dupline® Industrial

## Accessories





Types	ADAPT 1605	ANT1	ANT2	D3212 4000
				
Dimensions (mm)	25 x 50 x 100		15 x 35 x 120	36 x 70 x 77
Functions	Codings adaptor between GAP1605 and Dupline® modules without standard connection plug	GSM antenna 900 MHz	Active antenna used for radio controlled clock	Synchronizer module for analogue modules
Housing type	Handheld box		Glued plastic casing	H2 housing
<b>Electrical specifications</b>				
Features/Signal types	4 clip-on terminals for Dupline® modules. Includes a M12 plug for modules like G8911 1010		Input signal is 77.5 kHz	Max. 112 analogue signals with up to 12 bit resolution
Power supply		Powered by G3800 XXXX	Powered by G3800 XXXX	Powered by Dupline®
<b>General specifications</b>				
Degree of protection	IP 20	IP 67	IP 40	IP 40
Operating temperature	0°C to +50°C	-25°C to +60°C	0°C to +50°C	-20°C to +50°
Storage temperature	-20°C to +60°C	-20°C to +60°C	-20°C to +60°C	-50°C to +85°C
Remarks				Transmits always on A1-A4
<b>References</b>				
Adaptor	<b>ADAPT 1605</b>			
Antenna		<b>ANT1</b>	<b>ANT2</b>	
Synchronizer				<b>D3212 4000</b>

# Dupline® Industrial



## Accessories

Types	DT01/DT02	ETHCONV 2	ETHCONV 3	ETHCONV 4
				
Dimensions (mm)	17.5 x 70 x 77	22 x 75.2 x 80	22 x 90 x 100.4	29 x 89.2 x 118.5
Functions	Cable termination unit	Ethernet to RS232 converter	Ethernet to RS232 converter	Ethernet to RS485 converter
Housing type	H1 housing	Metal housing	Metal housing	Plast housing
<b>Electrical specifications</b>				
Number of channels		1	2	2
Features/Signal types	Removes distortion caused by reflection	1 port RJ45 10/100 Mbit TCP/IP based ethernet	2 port RJ45 10/100 Mbit TCP/IP based ethernet	2 port RJ45 10/100 Mbit TCP/IP based ethernet
Power supply	No power needed	12-48 VDC/130 mA	12-30 VDC/305 mA	12-30 VDC/305 mA
<b>General specifications</b>				
Degree of protection	IP 20	IP 20	IP 20	IP 30
Operating temperature	-20°C to +50°C	0°C to +55°C	0°C to +55°C	0°C to +55°C
Storage temperature	-50°C to +85°C	-40°C to +75°C	-40°C to +75°C	-40°C to +75°C
Remarks		Automatic dedicated installation tool available	Automatic dedicated installation tool available	Automatic dedicated installation tool available
<b>References</b>				
Standard Dupline®	<b>DT01</b>			
Hi-line Dupline®	<b>DT02</b>			
1 Channel		<b>ETHCONV2</b>		
2 Channels			<b>ETHCONV3</b>	<b>ETHCONV4</b>

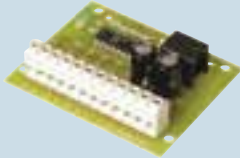
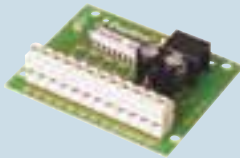

# Dupline® Irrigation

	Digital I/O modules		Converter	Tools
Types	GH3440 4412	GH6440 4412	GH3485 0000	GHTU8
				
Dimensions (mm)	77 x 72 x 70	80 x 77 x 50	77 x 72 x 70	145 x 90 x 28
Functions	I/O module for irrigation valve control	I/O module for irrigation valve control	Dupline® to Hi-Line converter	Dupline test unit for monitoring and control of Dupline® channels. Used for Hi-line modules
Housing type	DIN-Rail, H4	Fully molded housing for under ground installation	DIN-Rail, H4	Handheld
<b>Electrical specifications</b>				
Number of channels	4	4	Adjusts automatically	Adjusts automatically
Features/Signal types	2 outputs for control of 3-wire 12 VDC latching valve, and 2 contact inputs	2 outputs for control of 3-wire 12 VDC latching valve, and 2 contact inputs	Converts the Dupline® signal to Hi-Line 28 VDC level for control of irrigation valves (see GH3440 4412 and GH6440 4412)	Digital, multiplexed BCD and 8-bit analogue signals
Power supply	Powered through Hi-Line signal (see GH34850000)	Powered through Hi-Line signal (see GH34850000)	724 = 20-30 VDC	Powered through the Dupline® network
<b>General specifications</b>				
Degree of protection	IP 20	IP 67	IP 20	IP 40
Operating temperature	0°C to +50°C	0°C to +50°C	0°C to +50°C	0°C to +50°C
Storage temperature	-50°C to +85°C	-50°C to +85°C	-50°C to +85°C	-20°C to +85°C
Remarks				Options for latching digital signals and for reading multiplexed BCD values
<b>References</b>				
2 outputs and 2 inputs	<b>GH3440 4412</b>	<b>GH6440 4412</b>		
Converter			<b>GH3485 0000</b>	
Monitoring and control unit				<b>GHTU8</b>

# Dupline® Elevator

	Input module	Output module	Input/output module
<b>Types</b>	<b>G2120</b>	<b>G2130</b>	<b>G2140 4421</b>
			
<b>Dimensions (mm)</b>	Open PCB 72.3 x 59	Open PCB 74 x 59	Open PCB 54 x 40
<b>Functions</b>	8 contact inputs for push buttons or transistors. LED indications for supply and carrier	8 outputs for control of floor indicators and lamps. LED indications for supply and carrier	2 push button inputs. 2 PNP-transistor outputs. LED indications for supply and carrier
<b>Housing type</b>	Snap locks or DIN-rail (vertical or horizontal)	Snap locks or DIN-rail (vertical or horizontal)	Snap locks or DIN-rail (vertical or horizontal)
<b>Electrical specifications</b>			
<b>Number of channels</b>	8	8	4
<b>Features/Signal types</b>	3-wire operation with DC-power on wire 3	3-wire operation with DC-power on wire 3	3-wire operation with DC-power on wire 3
<b>Power supply</b>	700 = 10 - 30 VDC	700 = 10 - 30 VDC	700 = 10 - 30 VDC
<b>General specifications</b>			
<b>Operating temperature</b>	-20°C to +50°C	-20°C to +50°C	-20°C to +50°C
<b>References</b>			
<b>NPN</b>	<b>G2120 5501 700</b>	<b>G2130 5511 700</b>	
<b>PNP</b>	<b>G2120 5502 700</b>	<b>G2130 5521 700</b>	<b>G2140 4421 700</b>

# Dupline® Elevator

	Input/output module	Master modules	
Types	G2140 55.0	G2196	G3496
			
Dimensions (mm)	Open PCB 74 x 59	Open PCB 86 x 54	77 x 72 x 70
Functions	4 push-button inputs 4 transistor outputs LED indications for supply and carrier	128 signals RS 485/RS 232 interface to control system LED indications for supply, carrier and RS485Tx	Plug & Play RS232/RS485 Interface with built-in protocols for specific PLC brands and Modbus
Housing type	Snap locks or DIN-rail (vertical or horizontal)	Snap locks or DIN-rail (vertical or horizontal)	DIN-Rail, H4
<b>Electrical specifications</b>			
Number of channels	8	128 inputs and 128 outputs	Selectable
Features/Signal types	3-wire operation with DC-power on wire 3	3-wire operation with DC-power on wire 3	Possibility for 3-wire operation with DC-power on the 3 <sup>rd</sup> wire
Power supply	700 = 10 - 30 VDC	700 = 20 - 30 VDC	700 = 20 - 30 VDC
<b>General specifications</b>			
Degree of protection			IP 20
Operating temperature	-20°C to +50°C	-20°C to +60°C	0°C to +50°C
Storage temperature			-50°C to +85°C
Remarks			Built-in protocol for specific PLC brands for easy interfacing
<b>References</b>			
NPN	<b>G2140 5510 700</b>		
PNP	<b>G2140 5520 700</b>		
Standard protocol		<b>G2196 0000 700</b>	<b>G3496 0000</b>
Lucky Goldstar K-series		<b>G2196 0001 700</b>	<b>G3496 0001</b>
GE-Fanuc 90-30 series		<b>G2196 0002 700</b>	<b>G3496 0002</b>
Mitsubishi FX & A-series		<b>G2196 0003 700</b>	<b>G3496 0003</b>
Omron		<b>G2196 0004 700</b>	<b>G3496 0004</b>
Modbus RTU Slave		<b>G2196 0005 700</b>	<b>G3496 0005</b>
Allen-Bradley			<b>G3496 0006</b>
Schneider			<b>G3496 0007</b>
Koyo			<b>G3496 0008</b>
Matsushita			<b>G3496 0009</b>
Siemens			<b>G3496 0010</b>
Toshiba			<b>G3496 0011</b>
IDEC			<b>G3496 0012</b>









## OUR SALES NETWORK IN EUROPE

### AUSTRIA

Carlo Gavazzi GmbH  
Ketzergasse 374,  
A-1230 Wien  
Tel: +43 1 888 4112  
Fax: +43 1 889 10 53  
office@carlogavazzi.at

### BELGIUM

Carlo Gavazzi NV/SA  
Mechelsesteenweg 311,  
B-1800 Vilvoorde  
Tel: +32 2 257 4120  
Fax: +32 2 257 41 25  
sales@carlogavazzi.be

### DENMARK

Carlo Gavazzi Handel A/S  
Over Hadstenvej 40,  
DK-8370 Hadsten  
Tel: +45 89 60 6100  
Fax: +45 86 98 15 30  
handel@gavazzi.dk

### FINLAND

Carlo Gavazzi OY AB  
Petaksentie 2-4,  
FI-00661 Helsinki  
Tel: +358 9 756 2000  
Fax: +358 9 756 20010  
myynti@gavazzi.fi

### FRANCE

Carlo Gavazzi Sarl  
Zac de Paris Nord II, 69, rue de la Belle Etoile,  
F-95956 Roissy CDG Cedex  
Tel: +33 1 49 38 98 60  
Fax: +33 1 48 63 27 43  
french.team@carlogavazzi.fr

### GERMANY

Carlo Gavazzi GmbH  
Pfnorstr. 10-14  
D-64293 Darmstadt  
Tel: +49 6151 81000  
Fax: +49 6151 81 00 40  
info@gavazzi.de

### GREAT BRITAIN

Carlo Gavazzi UK Ltd  
4.4 Frimley Business Park,  
Frimley, Camberley, Surrey GU16 7SG  
Tel: +44 1 276 854 110  
Fax: +44 1 276 682 140  
sales@carlogavazzi.co.uk

### ITALY

Carlo Gavazzi SpA  
Via Milano 13,  
I-20020 Lainate  
Tel: +39 02 931 761  
Fax: +39 02 931 763 01  
info@gavazziacbu.it

### NETHERLANDS

Carlo Gavazzi BV  
Wijkmeerweg 23,  
NL-1948 NT Beverwijk  
Tel: +31 251 22 9345  
Fax: +31 251 22 60 55  
info@carlogavazzi.nl

### NORWAY

Carlo Gavazzi AS  
Melkeveien 13,  
N-3919 Porsgrunn  
Tel: +47 35 93 0800  
Fax: +47 35 93 08 01  
post@gavazzi.no

### PORTUGAL

Carlo Gavazzi Lda  
Rua dos Jerónimos 38-B,  
P-1400-212 Lisboa  
Tel: +351 21 361 7060  
Fax: +351 21 362 13 73  
carlogavazzi@carlogavazzi.pt

### SPAIN

Carlo Gavazzi SA  
Avda. Iparraguirre, 80-82,  
E-48940 Leioa (Bizkaia)  
Tel: +34 94 480 4037  
Fax: +34 94 431 6081  
gavazzi@gavazzi.es

### SWEDEN

Carlo Gavazzi AB  
V:a Kyrkogatan 1,  
S-652 24 Karlstad  
Tel: +46 54 85 1125  
Fax: +46 54 85 11 77  
info@carlogavazzi.se

### SWITZERLAND

Carlo Gavazzi AG  
Verkauf Schweiz/Vente Suisse  
Sumpfstrasse 3,  
CH-6312 Steinhausen  
Tel: +41 41 747 4535  
Fax: +41 41 740 45 40  
info@carlogavazzi.ch

## OUR SALES NETWORK IN THE AMERICAS

### USA

Carlo Gavazzi Inc.  
750 Hastings Lane,  
Buffalo Grove, IL 60089, USA  
Tel: +1 847 465 6100  
Fax: +1 847 465 7373  
sales@carlogavazzi.com

### CANADA

Carlo Gavazzi Inc.  
2660 Meadowvale Boulevard,  
Mississauga, ON L5N 6M6, Canada  
Tel: +1 905 542 0979  
Fax: +1 905 542 22 48  
gavazzi@carlogavazzi.com

### MEXICO

Carlo Gavazzi Mexico S.A. de C.V.  
Calle La Montaña no. 28, Fracc. Los Pastores  
Naucalpan de Juárez, EDOMEX CP 53340  
Tel & Fax: +52.55.5373.7042  
mexicosales@carlogavazzi.com

### BRAZIL

Carlo Gavazzi Automação Ltda. Av.  
Francisco Matarazzo, 1752  
Conj 2108 - Barra Funda - São Paulo/SP  
Tel: +55 11 3052 0832  
Fax: +55 11 3057 1753  
info@carlogavazzi.com.br

## OUR SALES NETWORK IN ASIA AND PACIFIC

### SINGAPORE

Carlo Gavazzi Automation Singapore Pte. Ltd.  
61 Tai Seng Avenue  
#05-06 UE Print Media Hub  
Singapore 534167  
Tel: +65 67 466 990  
Fax: +65 67 461 980  
info@carlogavazzi.com.sg

### MALAYSIA

Carlo Gavazzi Automation (M) SDN. BHD.  
D12-06-G, Block D12,  
Pusat Perdagangan Dana 1,  
Jalan PJU 1A/46, 47301 Petaling Jaya,  
Selangor, Malaysia.  
Tel: +60 3 7842 7299  
Fax: +60 3 7842 7399  
sales@gavazzi-asia.com

### CHINA

Carlo Gavazzi Automation  
(China) Co. Ltd.  
Unit 2308, 23/F.,  
News Building, Block 1, 1002  
Middle Shennan Zhong Road,  
Shenzhen, China  
Tel: +86 755 83699500  
Fax: +86 755 83699300  
sales@carlogavazzi.cn

### HONG KONG

Carlo Gavazzi Automation  
Hong Kong Ltd.  
Unit 3 12/F Crown Industrial Bldg.,  
106 How Ming St., Kwun Tong,  
Kowloon, Hong Kong  
Tel: +852 23041228  
Fax: +852 23443689

## OUR COMPETENCE CENTRES AND PRODUCTION SITES

### DENMARK

Carlo Gavazzi Industri A/S  
Hadsten

### MALTA

Carlo Gavazzi Ltd  
Zejtun

### ITALY

Carlo Gavazzi Controls SpA  
Belluno

### LITHUANIA

Uab Carlo Gavazzi Industri Kaunas  
Kaunas

### CHINA

Carlo Gavazzi Automation (Kunshan) Co., Ltd.  
Kunshan

## HEADQUARTERS

Carlo Gavazzi Automation SpA  
Via Milano, 13  
I-20020 - Lainate (MI) - ITALY  
Tel: +39 02 931 761  
info@gavazziautomation.com



**CARLO GAVAZZI**  
Automation Components

*Energy to Components!*

[www.gavazziautomation.com](http://www.gavazziautomation.com)

