

**PSSnet SLL Series – Devices
Unmanaged Ethernet Switches**

Industrial Ethernet Switches – PSSnet S



All rights to this documentation are reserved by Pilz GmbH & Co. KG. Copies may be made for internal purposes.

Suggestions and comments for improving this documentation will be gratefully received.

Pilz®, PIT®, PMI®, PNOZ®, Primo®, PSEN®, PSS®, PVIS®, SafetyBUS p®, SafetyEYE®, SafetyNET p®, the spirit of safety® are registered and protected trademarks of Pilz GmbH & Co. KG in some countries.

Content

	Content	4
	Safety instructions	5
	Legend	9
1	Device description	10
1.1	Description of the device variants	10
2	Assembly and start-up	12
2.1	Installing the device	12
2.1.1	Unpacking and checking	12
2.1.2	Installing the SFP modules (if present)	13
2.1.3	Connecting the terminal block for the supply voltage and the grounding	13
2.1.4	Mounting the device on the DIN rail	13
2.1.5	Dimensions	15
2.1.6	Installing the terminal block, start-up procedure	15
2.1.7	Connecting the data lines	15
2.2	Display elements	16
2.2.1	Device state	16
2.2.2	Port state	17
2.3	Disassembly	18
2.3.1	Removing the device from the DIN rail	18
3	Technical data	19
A	Further support	23

Safety instructions

■ Notes on safety

This manual contains instructions to be observed for ensuring your personal safety and for preventing damage. The warnings appear next to a warning triangle with a different heading depending on the degree of danger posed:



Danger!

Means that death, serious physical injury or significant damage to property **will occur** if the corresponding safety measures are not carried out.



Warning!

Means that death, serious physical injury or significant damage to property **could occur** if the corresponding safety measures are not carried out.



Caution!

Means that minor physical injury or damage to property can occur if the required safety measures are not carried out.

Note: Contains important information on the product, on how to manage the product, or on the respective section of the documentation to which your special attention is being drawn.

■ Certified usage

Please observe the following: The device may only be employed for the purposes described in the catalog and technical description, and only in conjunction with external devices and components recommended or approved by the manufacturer. The product can only be operated correctly and safely if it is transported, stored, installed and assembled properly and correctly. Furthermore, it must be operated and serviced carefully.

■ Supply voltage

The devices are designed for operation with a safety extra-low voltage. Accordingly, only SELV circuits with voltage restrictions in line with IEC/EN 60950-1 may be connected to the supply voltage connections.



Warning!

Only connect a supply voltage that corresponds to the type plate of your device.

- Use only undamaged parts.

- If you are operating the module with an external voltage, only supply the system with a safety extra-low voltage in compliance with IEC/EN 60950-1.
- Connect the ground connector before you set up the other connections. When removing the connections, you remove the ground connector last.
- Relevant for North America: To be used in class 2 circuits. The device may only be connected to a supply voltage of class 2 that fulfills the requirements of the National Electrical Code, Table 11(b).
- Relevant for North America: For use in Class 2 circuits. Only use copper wire/conductors of class 1, 60/75°C or 90 °C.
- Relevant for North America for devices certified for hazardous locations: Power, input and output (I/O) wiring must be in accordance with Class 1, Division 2 wiring methods [Article 501-4(b) of the National Electrical Code, NFPA 70] and in accordance with the authority having jurisdiction.
- Only switch on the device when the housing is closed.

■ Shielding ground

- Beware of possible short circuits when connecting a cable section with conductive shielding braiding.

■ Housing

Only technicians authorized by Pilz are permitted to open the housing.

Note: The device is grounded by means of a 3-pin terminal block.

- Make sure that the electrical installation meets local or nationally applicable safety regulations.
- The ventilation slits must not be covered so as to ensure free air circulation.
- The clearance to the ventilation slits of the housing must be at least 10 cm (3.94 in).
- The device must be installed in the vertical position.
- If installed in a living area or office environment, the device must be operated exclusively in switch cabinets with fire protection characteristics in accordance with EN 60950-1.



Warning!

Never insert sharp objects (small screwdrivers, wires, etc.) into the inside of the product. There is the risk of an electric shock.

■ **Environment**

The device may only be operated at the specified maximum ambient temperature (temperature of the ambient air at a distance of up to 5 cm (1.97 in) from the device) and relative air humidity.

- Install the device in a location where the climatic threshold values specified in the technical data are adhered to.
- Only to be used in an environment with the contamination level specified in the technical data.

■ **Qualification requirements for personnel**

Qualified personnel as understood in this manual and the warning signs, are persons who are familiar with the setup, assembly, startup, and operation of this product and are appropriately qualified for their job. This includes, for example, those persons who have been:

- ▶ trained or directed or authorized to switch on and off, to ground and to label power circuits and devices or systems in accordance with current safety engineering standards;
- ▶ trained or directed in the care and use of appropriate safety equipment in accordance with the current standards of safety engineering;
- ▶ trained in providing first aid.

■ **General safety instructions**

Electricity is used to operate this equipment. Comply in every detail with the safety requirements specified in the operating instructions regarding the voltages to apply.

Non-observance of these safety instructions can therefore cause material damage and/or serious injuries.

- Only appropriately qualified personnel should work on this device or in its vicinity. These personnel must be thoroughly familiar with all the warnings and maintenance procedures in accordance with this operating manual.
- The proper and safe operation of this device depends on proper handling during transport, proper storage and assembly, and conscientious operation and maintenance procedures.
- Never start operation with damaged components.
- Only use the devices in accordance with this manual. In particular, observe all warnings and safety-related information.
- Any work that may be required on the electrical installation may only be carried out by personnel trained for this purpose.

Relevant for PSSnet SLL....F..... with fiber optic ports.

Note:

LED or LASER components in compliance with IEC 60825-1 (2001):
CLASS 1 LASER PRODUCT
CLASS 1 LED PRODUCT

■ **National and international safety regulations**

- Make sure that the electrical installation meets local or nationally applicable safety regulations.

■ **Note on the CE marking**

The devices comply with the regulations contained in the following European directive(s):

2006/95/EG, 2004/108/EG

Directive of the European Parliament and the council for standardizing the regulations of member states with regard to electromagnetic compatibility.

72/245/EWG, 2006/28/EG

Guideline for standardizing the regulations of member states relating to radio interference from motor vehicles. Certified devices are marked with an e1 type approval indicator.

In accordance with the above-named EU directive(s), the EU conformity declaration will be at the disposal of the relevant authorities at the following address:

Pilz GmbH & Co. KG
Felix Wankel Str. 2
73760 Ostfildern
Tel.: +49 711 3409 0

The product can be used in living areas (living area, place of business, small business) and in industrial areas.

- ▶ Interference immunity: EN 61000-6-2:2005
- ▶ Emitted interference: EN 55022:2006 Class A



Warning

This is a class A device. This device can cause interference in living areas, and in this case the operator may be required to take appropriate measures.

The assembly guidelines provided in these instructions must be strictly adhered to in order to observe the EMC threshold values.

■ **FCC note:**

Appropriate testing has established that this device fulfills the requirements of a class A digital device in line with part 15 of the FCC regulations.

These requirements are designed to provide sufficient protection against interference when the device is being used in a business environment.

The device creates and uses high frequencies and can radiate same, and if it is not installed and used in accordance with this operating manual, it can cause radio transmission interference. The use of this device in a living area can also cause interference, and in this case the user is obliged to cover the costs of removing the interference.

■ **Recycling note**

After usage, this product must be disposed of properly as electronic waste in accordance with the current disposal regulations of your county / state / country.

Legend

The commendations used in this manual have the following meanings:

▶	Listing
□	Work step
■	Subheading

1 Device description

The PSSnet SLL devices are designed for the special requirements of industrial automation. They meet the relevant industry standards, provide very high operational reliability, even under extreme conditions, and also long-term reliability and flexibility.

The devices allow you to set up switched industrial ETHERNET networks that conform to the IEEE 802.3 and 802.3u standards using copper wires or optical fibers in a line structure.

The PSSnet SLL devices have, depending on the variant, 4 or 5 TP ports (10/100 Mbit/s, RJ45 socket) and one 100 Mbit/s F/O port (100BASE-FX SC connection).

Mount the devices by

- ▶ simply snapping them onto a DIN rail

Depending on the device variant, you can choose various media to connect terminal devices and other infrastructure components:

- ▶ twisted pair cable
- ▶ multimode F/O

The twisted pair ports support:

- ▶ Autocrossing
- ▶ Autonegotiation
- ▶ Autopolarity

The F/O ports support:

- ▶ Full duplex mode

1.1 Description of the device variants

The devices differ with regard to the number of interfaces and the media type for connecting segments.

The table below shows the number and type of the ports for each product variant. The abbreviations F/O (optical fiber) and TP (twisted pair) indicate the media type. The abbreviations SC and RJ45 indicate the socket type. The abbreviation MM (Multimode) indicate the optical fiber type.

Variant	10/100 Mbit/s, TP, RJ45	100 Mbit/s, F/O, MM, ST
PSSnet SLL 5T	5	
PSSnet SLL 4T 1FMMSC	4	1

Table 1: Number and type of ports

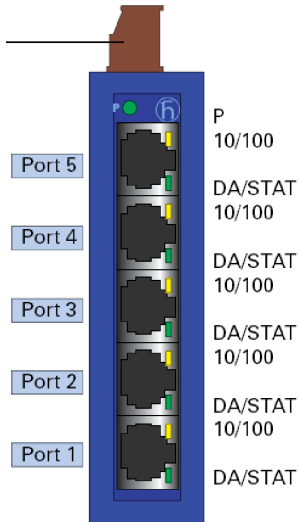

Figure 1: Overview of the device PSSnet SLL 5T with 5 ports in compliance with 10/100BASE-T(X) (RJ45 connections)

The following data applies in a cross-variant manner:

Operating voltage	9.6 to 32.0 V DC
Software variant	Unmanaged
Certifications / declarations	pending
	UL508 (E175531)

The devices comply with the specifications of the standard(s):

- ▶ ISO/IEC 8802-03 10BASE-T/100BASE-TX
- ▶ ISO/IEC 8802-03 100BASE-FX

2 Assembly and start-up

The devices have been developed for practical application in a harsh industrial environment. The installation process is correspondingly simple. On delivery, the device is ready for operation.

The following steps should be performed to install and configure a switch:

- ▶ Unpacking and checking
- ▶ Connecting the terminal block for the supply voltage and the grounding
- ▶ Mounting the device on the DIN rail
- ▶ Install the terminal block, start-up procedure
- ▶ Installing the data lines

2.1 Installing the device

2.1.1 Unpacking and checking

- Check whether the contents of the package are complete (see „Scope of delivery“).
- Check the individual parts for transport damage.

2.1.2 Installing the SFP modules (if present)

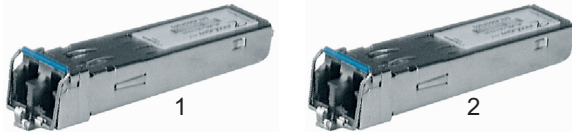

Figure 2: 1 - Fast EETHERNET fiber optic SFP module
2 - Gigabit EETHERNET fiber optic SFP module

- To attach an SFP module, first remove the protective cap over the socket.
- Push the SFP module with the lock closed into the socket until it latches audibly in place.

Note: Only use Pilz SFP modules.

2.1.3 Connecting the terminal block for the supply voltage and the grounding

A 3-pin terminal block is used for the grounding and for connecting the supply voltage.



Warning!

Only connect a supply voltage that corresponds to the type plate of your device.

Note: Relevant for North America:

The tightening torque of the terminal screws is max. 4.4 lb in. (0.5 Nm).

Figure	Pin	Assignment	Voltage range
	1	+ 24 V	9.6 to 32.0 V DC
	2	0 V	
	3	Ground connection	

Table 2: Pin assignment of the 3-pin terminal block for the supply voltage

- Pull the terminal block off the device.
- Connect the supply voltage lines.
- Connect the ground connection.

2.1.4 Mounting the device on the DIN rail

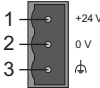

Caution!

Do not open the housing.

Note: The device is grounded by means of a 3-pin terminal block.

Note: The shielding ground of the connectable twisted pair lines is connected to the ground connection as a conductor.

- Mount the device on a 35 mm DIN rail in accordance with DIN EN 60175.
- Attach the upper snap-in guide of the device into the DIN rail and press it down against the DIN rail until it snaps into place.

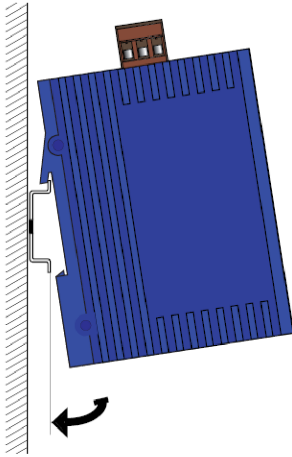

Figure 3: Mounting on the DIN rail

2.1.5 Dimensions

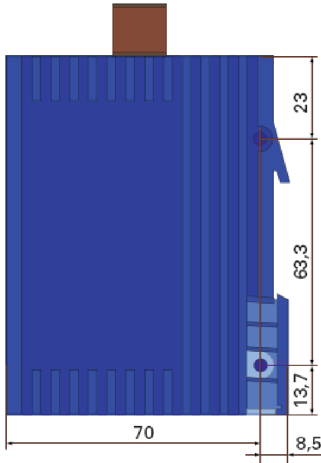

Figure 4: Dimensions of the PSSnet SLL

2.1.6 Installing the terminal block, start-up procedure



Warning!

Only connect a supply voltage that corresponds to the type plate of your device.

- Mount the terminal block for the supply voltage and the ground connection.

By connecting the voltage supply via the terminal block, you start the operation of the device.

2.1.7 Connecting the data lines

You can connect terminal devices and other segments at the ports of the device via twisted pair cables and F/O cables.

- Install the data lines according to your requirements.

■ 10/100 Mbit/s twisted pair connection

These connections are RJ45 sockets.

10/100 Mbit/s TP ports enable the connection of terminal devices or independent network segments according to the IEEE 802.3 10BASE-T/100BASE-TX standard.

These ports support:

- ▶ Autonegotiation

- ▶ Autopolarity
- ▶ Autocrossing
- ▶ 100 Mbit/s half-duplex mode, 100 Mbit/s full duplex mode
- ▶ 10 Mbit/s half-duplex mode, 10 Mbit/s full duplex mode

Figure	Pin	Function
	1+2	One line pair
	3+6	One line pair
	4,5,7,8	Not used

Table 3: Pin assignment of a TP/TX interface in MDI-X mode, RJ45 socket

■ 100 Mbit/s F/O connection PSSnet SLL...F...

For the device variants PSSnet SLL...F...SC, these ports are SC connectors.

100 Mbit/s F/O ports enable the connection of terminal devices or independent network segments in compliance with the IEEE 802.3 100BASE-FX standard.

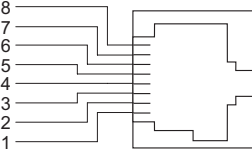
These ports support:

- ▶ Full duplex mode

Note: Make sure that the SM ports are only connected with SM ports, and MM ports only with MM ports.

2.2 Display elements

2.2.1 Device state

These LEDs provide information about conditions which affect the operation of the whole device.

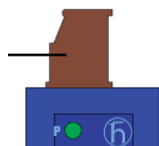

Figure 5: Device status LEDs
1 – Power LED (P)

LED	Display	Color	Activity	Meaning
P	Power	Green	Lights up	Supply voltage is on.
			None	Supply voltage is too low.

2.2.2 Port state

The green and yellow LEDs at the individual port display port-related information.

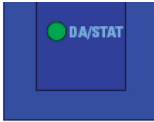

Figure 6: Port status LEDs for F/O ports on the low edge of the front of the device
 1 – No port status LEDs for devices without F/O ports
 2 – One port status LED (LS/DA) for devices with one F/O port

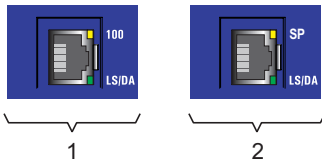

Figure 7: Port status LEDs for TP ports
 1 – Port status LEDs for Fast Ethernet TP ports
 2 – Port status LEDs for Gigabit Ethernet TP ports

LED	Display	Color	Activity	Meaning
LS/DA	Link status data	Green	Lights up	Valid connection
			Flashing	Data traffic
			None	No valid connection
100	Data rate	Yellow	Lights up	100 Mbit/s connection
			None	10 Mbit/s connection
SP	Data rate	Yellow	None	No valid connection
			Flashing 1 time a period	10 Mbit/s connection
			Flashing 2 times a period	100 Mbit/s connection
			Flashing 3 times a period	1000 Mbit/s connection

2.3 Disassembly

2.3.1 Removing the device from the DIN rail

- To take the device off the DIN rail, insert a screwdriver horizontally under the housing into the locking slide, pull it (without tipping the screwdriver) downwards and lift the device upwards.

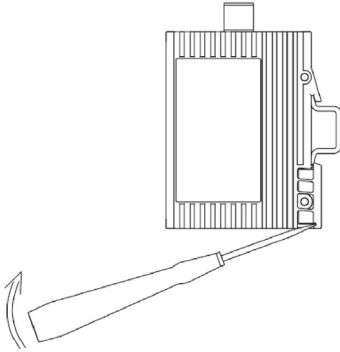

Figure 8: Removal from the DIN rail

3 Technical data

■ General technical data

Dimensions W x H x D incl. terminal block	PSSnet SLL 5T	25 mm x 114 mm x 79 mm
	PSSnet SLL 4T 1FMMSC	25 mm x 114 mm x 79 mm
Weight	PSSnet SLL 5T	113 g
	PSSnet SLL 4T 1FMMSC	120 g
Power supply	Operating voltage	9.6 to 32.0 V DC Safety extra-low voltage (SELV) Relevant for North America: Nec Class 2 power source max. 5A.
	Buffer time	min. 10 ms at 20.4 V DC
Potential difference between incoming voltage and housing	Potential difference from incoming voltage +24 V DC	32 V DC
	Potential difference from incoming voltage, ground	-32 V DC
Environment	Storage temperature (ambient air)	-40 °C to +70 °C
	Humidity	to 95% (non-condensing)
	Air pressure	Up to 2000 m (795 hPa), higher alti- tudes on request
Operating tempera- ture		0 °C to +60 °C
Contamination level		2
Protection classes	Laser protection	Class 1 according to EN 60825-1 (2001)
	Protection class	IP 30

■ EMC and immunity

EMC interference immunity

IEC/EN 61000-4-2	Electrostatic discharge	
	Contact discharge	+/- 4 kV
	Air discharge	+/- 8 kV
IEC/EN 61000-4-3	Electromagnetic field	
	80 - 2,700 MHz	20 V/m
IEC/EN 61000-4-4	Fast transients (burst)	
	DC power line	+/- 2 kV (2.5 kHz)
	Data line	+/- 4 kV (2.5 kHz)

EMC interference immunity

IEC/EN 61000-4-5	Voltage surges	
	DC power line, line / line	+/- 1 kV
	DC power line, line / earth	+/- 2 kV
	Data line, line / earth	+/- 1 kV
IEC/EN 61000-4-6	Line-conducted interference voltages	
	150 kHz - 80 MHz	10 V

EMC emitted interference

EN 55022	Class A
FCC 47 CFR Part 15	Class A

Stability

Vibration	IEC 60068-2-6, test Fc	5 Hz to 9 Hz with 3.5 mm amplitude; 1g at 9 Hz to 150 Hz; 1.5 g at 200 Hz to 250 Hz
	IEC 60068-2-6, resonance search / resonance dwell, test Fc	2 Hz to 13.2 Hz with 1 mm amplitude; 0.7 g at 13.2 Hz to 100 Hz
Shock	IEC 60068-2-27 test Ea	15 g at 11 ms

■ Network range

TP port

Length of a twisted pair segment	max. 100 m / 300 ft
----------------------------------	---------------------

Table 4: TP port 10BASE-T / 100BASE-TX

Product code	F/O type	Wave length	Fiber	System at-tenuation	Expansion	Fiber data
PSSnet SLL 4T 1FMMSC	MM	1300 nm	50/125 µm	0-8 dB	0-5 km	1.0 dB/km; 800 MHz*km
PSSnet SLL 4T 1FMMSC	MM	1300 nm	62.5/125 µm	0-11 dB	0-4 km	1.0 dB/km; 500 MHz*km

Table 5: F/O port 100BASE-FX

MM = Multimode, SM = Singlemode

■ Power consumption/power output at 24 V DC

Device name	Max. power consumption	Power output
PSSnet SLL 5T	2.2 W	7.5 Btu (IT)/h
PSSnet SLL 4T 1FMMSC	3.9 W	13.3 Btu (IT)/h

■ Scope of delivery

Device	Scope of delivery
PSSnet SLL....	Device
	Terminal block for the supply voltage
	Installation user manual

■ Order numbers

Device	Order number
PSSnet SLL 5T	380 600
PSSnet SLL 4T 1FMMS	380 604

■ Underlying norms and standards

Norm	
cUL 508:1998	Safety for Industrial Control Equipment
EN 55022:2006	IT equipment – radio interference characteristics
EN 61000-6-2:2005	Generic norm – immunity in industrial environments
EN 61131-2:2003	Programmable logic controllers
IEC/EN 60950-1:2006	Safety for the installation of IT equipment
FCC 47 CFR Part 15:2006	Code of Federal Regulations

Table 6: List of norms and standards. Certified devices are marked with a certification indicator. From the imprint on the device label you will see the current certification status of your device.

A Further support

■ **Technical questions and training courses**

In the event of technical queries, please contact your local Pilz distributor or Pilz office.

You can find the addresses of our distributors on the Internet:

www.pilz.com.

Our support line is also at your disposal:

▶ Tel.: +49 711 3409 444

▶ Fax +49 711 3409 133

The current training courses to technology and products can be found under <http://www.pilz.com>.