

## Anbausätze für Stellungsregler Attachment kits for positioners Kits de montage pour les positionneurs



Diese Technische Information für Anbausätze bietet eine Übersicht über Anbaumöglichkeiten von Foxboro Eckardt Stellungsreglern und Stellungsumformern an gängige Hub- und Schwenkantriebe.

This technical information gives an overview of the attachment possibilities of Foxboro Eckardt Positioners and Positions transmitters on linear and rotative actuators.

Cette information technique donne une vue d'ensemble des possibilités de montage des positionneurs et recopies de position de Foxboro Eckardt sur des servomoteurs linéaires ou rotatifs.

**Standard-Anbausätze  
Standard attachment kits  
Kits de montage standard**

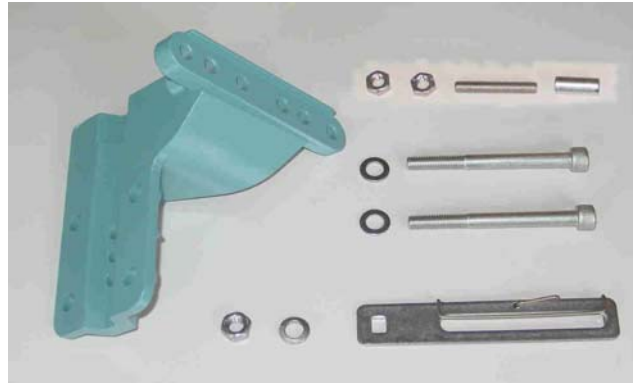

Type / Version	Model Code of attachment kit	SRD998	RMU998-V	RMU998-W	SRD991 SR1990	SRD960	SRP981	SR1983	SR1986	SGE985 SM1983 SMF981
----------------	------------------------------	--------	----------	----------	------------------	--------	--------	--------	--------	----------------------------

**Hubantriebe / Linear actuators / Servomoteurs linéaires NAMUR**

	EBZG-GN	EBZG-HN	EBZG-IN	EBZG-H	EBZG-H1	EBZG-H7					
<b>Für Gußlaterne / for casting yoke / pour arcade</b>	(incl. Standard-Anlenkhebel/ incl. standard couple lever / incl. Levier de raccordement standard a=72mm )										
	(incl. Standard-Anlenkhebel/ incl. standard couple lever / incl. Levier de raccordement standard a=72mm )										
	(EBZG-HN mit Winkel / EBZG-HN with small mounting bracket / EBZG-HN avec equerre courte)										
	(incl. Standard-Anlenkhebel/ incl. standard couple lever / incl. Levier de raccordement standard Hub/stroke/course 8-70mm)										
	(EBZG-H1 mit kurz Winkel / EBZG-H1 with small mounting bracket / EBZG-H1 avec equerre courte)										
	(Edelstahl / Stainless steel / Inox)										

	EBZG-FN	EBZG-KN	EBZG-K	EBZG-K1	EBZG-K5	EBZG-K7					
<b>Für Pfeilerlaterne / for pillar yoke / pour arcade à pilier</b>	(incl. Standard-Anlenkhebel/ incl. standard couple lever / incl. Levier de raccordement standard a=72mm )										
	(incl. Standard-Anlenkhebel/ incl. standard couple lever / incl. Levier de raccordement standard a=72mm )										
	(incl. Standard-Anlenkhebel/ incl. standard couple lever / incl. Levier de raccordement standard Hub/stroke/course 8-70mm)										
	(incl. Standard-Anlenkhebel/ incl. standard couple lever / incl. Levier de raccordement standard Hub/stroke/course 8-70mm)										
	(incl. Standard-Anlenkhebel/ incl. standard couple lever / incl. Levier de raccordement standard Hub/stroke/course 8-70mm)										
	(Edelstahl / Stainless steel / Inox)										

**VDI/VDE 3847 Part 1 for linear actuator**

Mounting according to the VDI/VDE3847 part1	EBZG-N1								
	EBZG-N4								

**Für Hubantriebe / for linear actuators / pour actionneurs linéaires**

For arcade without drilling	EBZG-H5								

**Zubehör / accessories / accessoires**

For some applications for example like large stroke, the above kits can be completed with accessories describe in page 3 and 4.

Für spezielle Anwendungen, z.B. bei längerem Hub, können die oben genannten Teilesätze mit dem Zubehör auf S.3 und S.4 ergänzt werden.

Pour des applications comme par exemple des très grandes courses, les kits ci dessous peuvent être completer par des accessoires décrits page 3 et 4.

**Anlenkhebel für SRD991 - SRI990 - SRD960 - SRD998**  
**Feedback lever for SRD991 - SRI990 - SRD960 - SRD998**  
**Levier de raccordement pour SRD991 - SRI990 - SRD960 - SRD998**

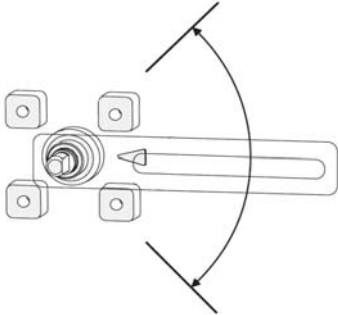

**Maximum rotation of Feedback lever  
 for SRD991 - SRI990 - SRD960 is 90°  
 for SRD998 is 120°**

**EBZG-A**

Feedback lever for stroke 8 to 70mm

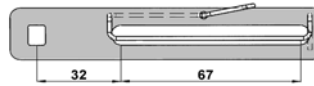

**EBZG-B**

Feedback lever for stroke 60 to 120mm

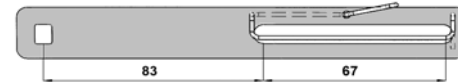

**EBZG-A1**

Extended feedback lever for stroke 110 to 260mm

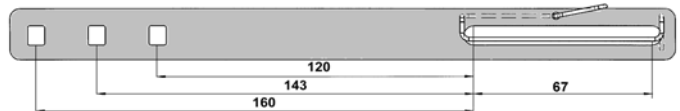

**EBZG-A2**

Extra short feedback lever for stroke 5 to 15mm

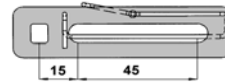

**EBZG-A3**

Feedback lever fold for stroke 8 to 70mm



**EBZG-A4**

Short feedback lever for stroke 8 to 35mm

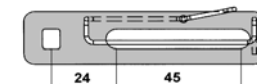

**EBZG-NW**

Locknut (M8) and washer



Extended lever for SRD991-SRI990-SRD960-SRD998 for stroke > 260mm available on request  
 Anlenkhebel für SRD991-SRI990-SRD960-SRD998 für Hubbereich > 260mm auf Anfrage  
 Leviers pour SRD991-SRI990-SRD960-SRD998 pour course > 260mm sur demande

**Anlenkhebel für SRP981-SRI983 - SRI986 - SMI983 - SMP981 - SGE985**  
**Feedback lever for SRP981-SRI983 - SRI986 - SMI983 - SMP981 - SGE985**  
**levier de raccordement pour SRP981-SRI983 - SRI986 - SMI983 - SMP981 - SGE985**

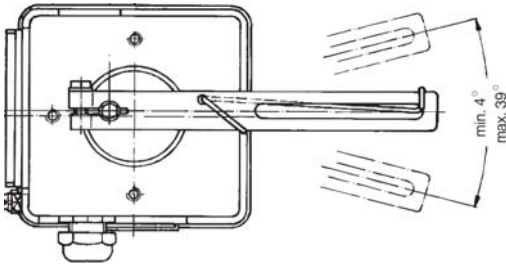

**Maximum rotation of Feedback lever for SRP981 - SRI983 - SRI986 - SMI983 - SMP981 - SGE985 is 39°**

**EBZG-ON**  
 Feedback lever for stroke up to 50mm

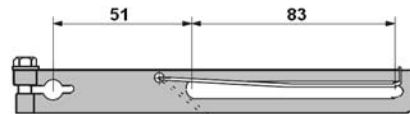

**EBZG-AN**  
 Feedback lever for stroke up to 80mm

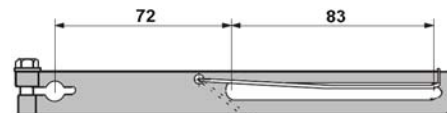

**EBZG-AN1**  
 Feedback lever for stroke 100mm to 150mm

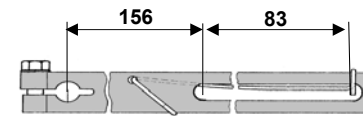

**EBZG-AN2**  
 Feedback lever for stroke 130mm to 170mm

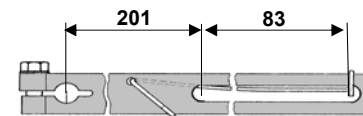

**EBZG-AN3**  
 Feedback lever for stroke 170mm to 210mm

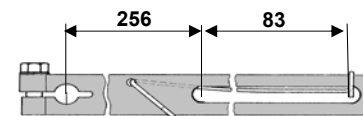

**EBZG-AN4**  
 Feedback lever for stroke 190mm to 230mm

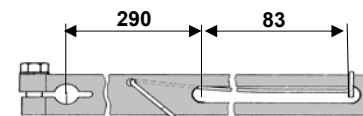

**EBZG-AN5**  
 Feedback lever for stroke 210mm to 250mm

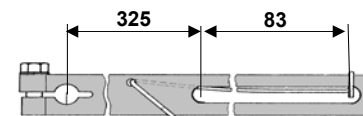

**EBZG-BN**  
 Feedback lever for stroke up to 100mm

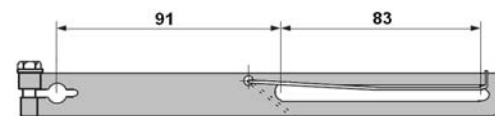

Extended lever for SRP981-SRI983-SRI986 up to 250mm available on request  
 Anlenkhebel für SRP981-SRI983-SRI986 mit verlängertem Hubbereich bis 250 mm auf Anfrage  
 Leviers pour SRP981-SRI983-SRI986 pour course jusqu'à 250mm disponible sur demande

Anlenkbolzen Carrier bolt Doigt d'entraînement	Anlenkbolzen mit Befestigung system Carrier bolt with fixing system Doigt d'entraînement avec système de fixation
--	---

**SRXG-A**

Extra short carrier bolt 23mm



**SRXG-B**

Adjustable carrier bolt  
( 20mm up to 37mm )

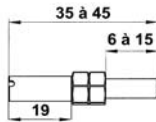

**SRXG-C**

Carrier bolt 38mm

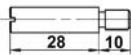

**SRXG-D**

Carrier bolt 47mm

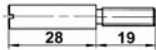

**SRXG-E**

Carrier bolt 57mm

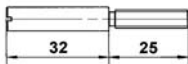

**SRXG-F**

Carrier bolt 65mm

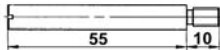

**SRXG-I**

Carrier bolt 80mm

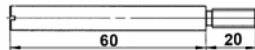

**SRXG-J**

Adjustable carrier bolt 3/8" / M6

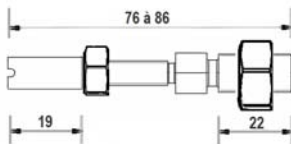

**SRXG-K**

Adjustable carrier bolt 5/16" / M6

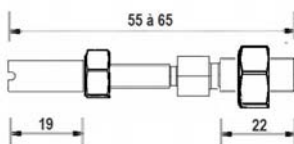

**SRXG-L**

Extension for carrier bolt

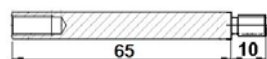

**SRXG-G**

Adjustable carrier bolt (SRXG-B)  
with fixing system for stem diameter up to 21mm

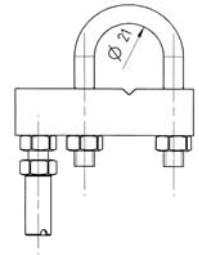

**SRXG-G1**

Adjustable carrier bolt (SRXG-B)  
with fixing system for stem diameter up to 21mm

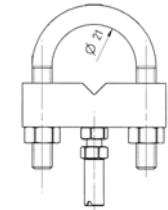

**SRXG-G2**

Adjustable carrier bolt (SRXG-B)  
with fixing system for stem diameter up to 21mm  
with extension up to 80 mm

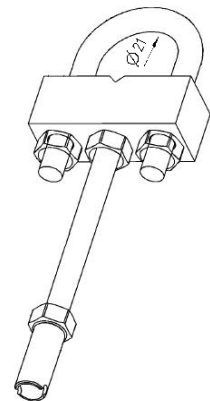

**SRXG-H**

Adjustable carrier bolt (SRXG-B)  
with fixing system for stem diameter up to 34mm

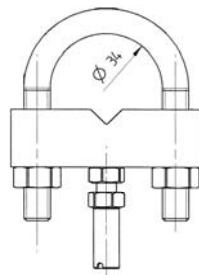

**SRXG-M**

Adjustable carrier bolt (SRXG-B)  
with fixing system for stem diameter up to 64mm

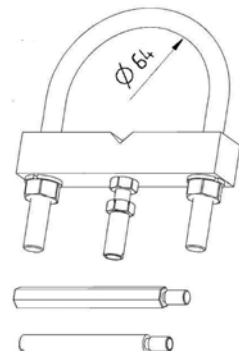

**Standard-Anbausätze  
Standard attachment kits  
Kits de montage standard**



Type / Version	Model Code of attachment kit	SRD988	RMU988-V	RMU988-W	SRD981 SR990	SRD960	SRP981	SR1983	SR1986	SGE985 SM1983 SMP981
----------------	------------------------------	--------	----------	----------	-----------------	--------	--------	--------	--------	----------------------------

**Schwenkantriebe / Rotary actuators / Servomoteurs rotatifs VDI/VDE 3845**

Kupplung / coupling piece / pièce d'accouplement	EBZG-R	•	•		•	•				
	EBZG-R2 reinforced kit	•	•		•	•				
	EBZG-ZN (mit Welle / with shaft / avec arbre)						•	•	•	•

**Anbaukonsole / bracket / console de montage VDI/VDE 3845**

Die meisten Schwenkantriebe nach VDI/VDE 3845 werden einschließlich Anbaukonsole geliefert. Falls nicht, können Sie einen der unten aufgeführten EBZG-Cx bestellen. Unbedingt Maße "A", "B" und "C" beachten.

Most rotary actuators (according to VDI/VDE 3845) have included a mounting bracket. If not, order EBZG-Cx as indicated below. Measure dimensions "A", "B" and "C" for proper selection.

La plupart des servomoteurs rotatif selon VDI/VDE 3845 sont déjà pourvu de console de montage, si ce n'est pas le cas vous pouvez le commander en fonction de la taille du servomoteur (mesures A, B et C)

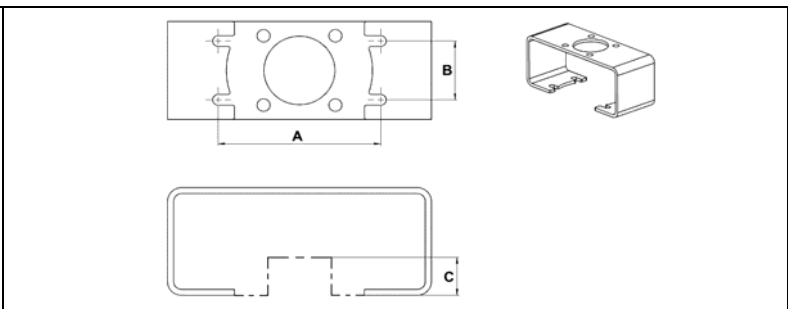

EBZG-C1	•	•		•	•	•	•	•	•	•
(A = 80 mm B = 30 mm C = 20 mm)										(A = 3,150 in B = 1,181 in C = 0,787 in)
EBZG-C2	•	•		•	•	•	•	•	•	•
(A = 80 mm B = 30 mm C = 30 mm)										(A = 3,150 in B = 1,181 in C = 1,181 in)
EBZG-C3	•	•		•	•	•	•	•	•	•
(A = 130mm B = 30 mm C = 50mm)										(A = 5,118 in B = 1,181 in C = 1,968 in)
EBZG-C4	•	•		•	•	•	•	•	•	•
(A = 130 mm B = 30 mm C = 30 mm)										(A = 5,118 in B = 1,181 in C = 1,181 in)
EBZG-C6	•	•		•	•	•	•	•	•	•
(A = 200 mm B = 50 mm C = 80 mm)										(A = 7,874 in B = 1,968 in C = 3,150 in)
EBZG-C7	•	•		•	•	•	•	•	•	•
(A = 50 mm B = 25 mm C = 15 mm)										(A = 1,968 in B = 0,984 in C = 0,590 in)

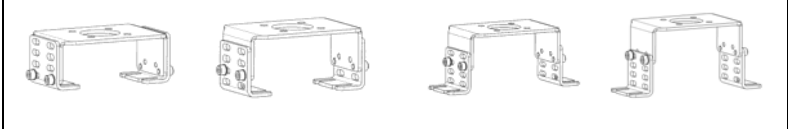

EBZG-C5 universal braket	•	•		•	•	•	•	•	•	•
(A = 80 to 130mm C = 30 to 50mm)										(A = 3,150 to 5,118 in C = 1,181 to 1,968 in)

**Zubehör / accessories / accessoires**

Kurvenscheibe / cam / came	EBZG-CN						•	•	•	•
	(Kurvenscheibe invers gleichprozentig / inverse equal percentage cam / came inverse égal pourcentage)						•	•	•	•
	EW529062023						•	•	•	•

(Kurvenscheibe für 180° Drehung / cam for 180° rotation / came pour une rotation de 180°)

**VDI/VDE 3847 Part 2 for rotary actuator**

Direct Mounting of positioner	EBZG-N51	•			•					
-------------------------------	----------	---	--	--	---	--	--	--	--	--

**Standard- und Sonder- Anbausätze, sortiert nach Hersteller / Typ des Antriebes**  
**Standard and specific attachment kits classify by manufacturer / type of actuator**  
**Kits de montage standard et spécifique par constructeurs / type de servomoteur**

Type / Version	Model Code of attachment kit	SRD998	RMU998-V	RMU998-W	SRD991 SR1990	SRD960	SRP981	SR1983	SR1986	SCE985 SM1983 SMP981
<b>ABB</b>										
Model DSCV-G111/D16R	EBZG-Q2				•	•				
Model DSCV-G111/D28R	EBZG-Q1	•			•	•				
<b>ADAREG</b>										
	EBZG-H3	•			•	•				
Micro flow (type NM1 1/2")	EBZG-H4				•	•				
Without drilling the actuator / without existing holes	EBZG-H5	•			•	•				
<b>AIR TORQUE</b>										
Schwenkantrieb / rotary actuator / servomoteur rotatif VDI/VDE 3845 => page 6 Anbaukonsole / Mounting bracket / console de montage VDI/VDE 3845 => page 14										
<b>AIRTEC ROCKY VALVE</b>										
DC-1212-15D	EBZG-RON								•	
<b>AMC &amp; BAILEY</b>										
(1) Cylinder Type SME0608	EBZG-X4	•	•		•	•				
(1) Cylinder Old Type	EBZG-X5	•	•		•	•				
<b>AMG</b>										
Schwenkantrieb / rotary actuator / servomoteur rotatif VDI/VDE 3845 => page 6 Anbaukonsole / Mounting bracket / console de montage VDI/VDE 3845 => page 14										
<b>AMRI - KSB</b>										
Schwenkantrieb / rotary actuator / servomoteur rotatif VDI/VDE 3845 => page 6										
(1) Old rotary actuator	EBZG-X3 (1)	•			•	•				
<b>AMSTRONG</b>										
Amstrong Valves from sizes 1" to 3"	EBZG-AM						•	•	•	
Amstrong Valves from sizes 1" to 3"	EBZG-AM1	•	•		•	•				
Amstrong 1500 Series Python valve	EBZG-AM3	•			•	•				
<b>ARCA</b>										
Baureihe 812	EBZG-GN						•	•		•
	EBZG-HN								•	
	EBZG-H	•			•	•				
Direct-mounting	EBZG-P2				•	•				
<b>ARI</b>										
	EBZG-FN						•	•		•
	EBZG-KN								•	
	EBZG-K	•			•	•				
Direct-mounting	EBZG-P1				•	•				
<b>AUTOMAX (FLOWSERVE)</b>										
Super Nova serie	Schwenkantrieb / rotary actuator / servomoteur rotatif VDI/VDE 3845 => page 6									
<b>BAR</b>										
Schwenkantrieb / rotary actuator / servomoteur rotatif VDI/VDE 3845 => page 6										
<b>BETTIS</b>										
Rotary G Series and Rack and pinion RPC series	Schwenkantrieb / rotary actuator / servomoteur rotatif VDI/VDE 3845 => page 6									
<b>BIFFI</b>										
Schwenkantrieb / rotary actuator / servomoteur rotatif VDI/VDE 3845 => page 6										
Old rotary actuator	EBZG-J	•	•		•	•				
	EBZG-JN						•	•	•	•
<b>Bormann &amp; Neupert</b>										
Schwenkantrieb / rotary actuator / servomoteur rotatif VDI/VDE 3845 => page 6										
<b>Bray</b>										
Series 90/91	Schwenkantrieb / rotary actuator / servomoteur rotatif VDI/VDE 3845 => page 6									
<b>Cashco</b>										
Linear actuators type 25, 30, 55, 75, 115 Direct and Reverse	EBZG-GN						•	•		•
	EBZG-HN								•	
	EBZG-H	•			•	•				
Rotary spring diaphragm type 48, 148, 148X	EBZG-PN						•	•	•	•
	EBZG-R	•	•		•	•				

(1) One genuine part of AMRI is worked and used for feedback coupling part  
 Ein nachgearbeitetes Originalteil von AMRI dient als Kupplung in diesem Anbausatz  
 Une pièce d'origine AMRI est ré-usinée pour l'entraînement du positionneur

**Standard- und Sonder- Anbausätze, sortiert nach Hersteller / Typ des Antriebes**  
**Standard and specific attachment kits classify by manufacturer / type of actuator**  
**Kits de montage standard et spécifique par constructeurs / type de servomoteur**

Type / Version	Model Code of attachment kit	SRD998	RMU998-V	RMU998-W	SRD991 SR1990	SRD960	SRP981	SR1963	SR1966	SGE985 SM1983 SMP981
<b>EBRO</b>	Schwenkantrieb / rotary actuator / servomoteur rotatif VDI/VDE 3845 => page 6									
<b>EL-O-MATIC</b>	Schwenkantrieb / rotary actuator / servomoteur rotatif VDI/VDE 3845 => page 6 Anbaukonsole / Mounting bracket / console de montage VDI/VDE 3845 => page 14									
<b>ENCORDIA</b>										
Type DO45 and DO56	EBZG-AM2				•	•				
<b>FESTO</b>	Schwenkantrieb / rotary actuator / servomoteur rotatif VDI/VDE 3845 => page 6									
<b>FIP</b>										
Others sizes please contact us	EBZG-TM4				•	•	•			
<b>FISHER</b>										
Type 657,type 667 (linear) sizes 30 - 40	EBZG-F1	•			•	•				
	EBZG-TN (1)						•	•		•
	EBZG-QN (1)								•	
Type 657,type 667 (linear) sizes 45 - 60	EBZG-F3	•			•	•				
Type 657,type 667 (linear) sizes 70-100	EBZG-F4	•			•	•				
Type 3024S (linear)	EBZG-FN						•	•		•
	EBZG-KN								•	
	EBZG-K	•			•	•				
Type 1250 (linear)	EBZG-FN						•	•		•
	EBZG-KN								•	
	EBZG-K	•			•	•				
(1) Type 1051, 1052 (rotary) size 20	EBZG-F9	•	•		•	•				
(1) Type 1051, 1052 and 1061 (rotary) size 33	EBZG-F5	•	•		•	•				
(1) Type 1051, 1052 and 1061 (rotary) size 40, size 30	EBZG-F2	•	•		•	•				
(1) Type 1051, 1052 and 1061 (rotary) size 60	EBZG-F6	•	•		•	•				
Valve/Actuator GX (linear)	EBZG-GN						•	•		•
	EBZG-HN								•	
	EBZG-H	•			•	•				
<b>FISHER - BAUMANN</b>										
9000 sries	EBZG-F7	•			•	•				
42000 sries	EBZG-F8	•			•	•				
24000 series (linear)	EBZG-GN						•	•		•
	EBZG-HN								•	
	EBZG-H + SRXG-K	•			•	•				
<b>FISHER - GULDE</b>										
Type P	EBZG-UN						•	•		•
(2) Type S	EBZG-FN						•	•		•
	EBZG-KN								•	
	EBZG-K	•			•	•				

- (1) Since this reference covers a wide range of actuators, the user might have to adapt certain attachment kits for some actuators slightly  
 Da sich diese Referenz auf eine größere Anzahl von Antrieben bezieht, könnten geringfügige Änderungen bei Anbausätzen einiger Antriebe erforderlich sein  
 Comme cette référence couvre une très large gamme de servomoteurs, il se peut que le client pour quelques servomoteurs soit obligé d'adapter légèrement notre kit de montage
- (2) For some application mounting square must be worked  
 Für manche Anwendungen muss der Anbauwinkel nachgearbeitet werden  
 Pour certains servomoteurs, l'équerre de montage doit être usinée (raccourcie).



**Standard- und Sonder- Anbausätze, sortiert nach Hersteller / Typ des Antriebes**  
**Standard and specific attachment kits classify by manufacturer / type of actuator**  
**Kits de montage standard et spécifique par constructeurs / type de servomoteur**

Type / Version	Model Code of attachment kit	SRD998	RMU998-V	RMU998-W	SRD991 SRI990	SRD980	SRP981	SRI983	SRI986	SGE985 SMI983 SMP981
<b>FOXBORO</b>										
P-Series	EBZG-H1	•			•	•				
	EBZG-HN								•	
	EBZG-GN						•	•		•
<b>GEFA</b>										
Schwenkantrieb / rotary actuator / servomoteur rotatif VDI/VDE 3845 => page 6										
<b>GEMU</b>										
Type 514 40D 1375 1 4 2061	EBZG-TM2			•	•					
Type 514 50D 1375 1 2 2061	EBZG-TM3			•	•					
Others sizes please contact us										
<b>GEORG FISCHER (+GF+)</b>										
Diastar (5 sizes: Head Ø =68-96-120-150 or 180mm)	EBZG-TM1			•	•					
Others sizes please contact us										
<b>HAGAN</b>										
Cylinder 2 1/2 X5 Thrust type swivel power positioner	EBZG-X1	•			•	•	<- righthand mounting			
	EBZG-X2	•			•	•	<- lefthand mounting			
Others sizes please contact us										
<b>HONEYWELL</b>										
Baureihe 2000 (pillar yoke)	EBZG-FN						•	•		•
	EBZG-KN								•	
	EBZG-K	•			•	•				
Air-O-Motor Type 05	EBZG-SA						•	•	•	•
<b>HYTORK</b>										
Excel, Genesis, ....	Schwenkantrieb / rotary actuator / servomoteur rotatif VDI/VDE 3845 => page 6									
<b>IAL</b>										
	EBZG-VN						•	•		
	EBZG-WN								•	
<b>INGERSOLL - RAND</b>										
	EBZG-W2	•			•					
	EBZG-KN								•	
	EBZG-K	•			•	•				
<b>JAMESBURY</b>										
Quadra Power (old type)	EBZG-J1	•	•		•	•				
RP-SR Series (old type)	EBZG-J2	•	•		•	•				
<b>KEYSTONE (TYCO)</b>										
Model 79D, 79U, TRP	Schwenkantrieb / rotary actuator / servomoteur rotatif VDI/VDE 3845 => page 6 Anbaukonsole / Mounting bracket / console de montage VDI/VDE 3845 => page 14									
<b>KAMMER (FLOWSERVE)</b>										
( for direct mounting ) ( for direct mounting )	EBZG-FN						•	•		•
	EBZG-KN								•	
	EBZG-E				•					
	EBZG-E1	•				•				
	EBZG-K				•	•				
<b>KINETROL</b>										
Model 05	EBZG-K2	•	•		•	•				
Model 07	EBZG-K3	•	•		•	•				
Model 09	EBZG-K4	•	•		•	•				
Others Model contact us										
<b>KOSO</b>										
Models 110D + 501D + 511D	EBZG-H	•			•	•				

(1) Since this reference covers a wide range of actuators, the user might have to adapt certain attachment kits for some actuators slightly  
 Da sich diese Referenz auf eine größere Anzahl von Antrieben bezieht, könnten geringfügige Änderungen bei Anbausätzen einiger Antriebe erforderlich sein  
 Comme cette référence couvre une très large gamme de servomoteurs, il se peut que le client pour quelques servomoteurs soit obligé d'adapter légèrement notre kit de montage

**Standard- und Sonder- Anbausätze, sortiert nach Hersteller / Typ des Antriebes**  
**Standard and specific attachment kits classify by manufacturer / type of actuator**  
**Kits de montage standard et spécifique par constructeurs / type de servomoteur**

Type / Version	Model Code of attachment kit	SRD998	RMU998-V	RMU998-W	SRD991 SRI990	SRD960	SRP981	SRI983	SRI986	SGE985 SMI983 SMP981
<b>MASONEILAN</b>										
37/38 (linear) sizes 15 / 18	EBZG-TN (1)						•	•		•
	EBZG-QN (1)								•	
37/38 (linear) sizes 9 / 11 / 13	EBZG-M2	•			•	•				
	EBZG-TN (1)						•	•		•
87/88 all size (linear)	EBZG-QN (1)								•	
	EBZG-M6	•			•	•				
87/88 with stroke < 80mm	EBZG-DN (1)								•	
	EBZG-EN (1)						•	•		•
87/88 with stroke > 80mm	EBZG-M4	•			•	•				
28000 Series	EBZG-M4 + EBZG-B	•			•	•				
	EBZG-LN								•	
	EBZG-MN						•	•		•
Paramax	EBZG-M5	•			•	•	Not valid for SRI990!			
CAMFLEX I					planned	planned				
35000 Series CAMFLEX II	EBZG-M8 (new design)	•	•		•	•				
	EBZG-RN						•	•	•	•
MINITORK I	EBZG-M	•	•		•	•				
37000 Series MINITORK II	EBZG-M9	•			•	•	←- The thread where the carrier bolt is screwed muss be adapted to M6			
	EBZG-RN						•	•	•	•
47/48 SIGMA F	EBZG-M	•	•		•	•			•	•
	EBZG-SN						•	•	•	•
71 DOMOTOR size A	EBZG-M1	•	•		•	•				
	EBZG-M7				•	•				
<b>MECAIR</b>										
Serie NOVA	Schwenkantrieb / rotary actuator / servomoteur rotatif VDI/VDE 3845 => page 6									
<b>NAF (FLOWSERVE)</b>										
NAF-RC	Schwenkantrieb / rotary actuator / servomoteur rotatif VDI/VDE 3845 => page 6									
NAF-Turnex (direct mounting)	EBZG-N9	•	•		•	•				

(1) Since this reference covers a wide range of actuators, the user might have to adapt certain attachment kits for some actuators slightly  
 Da sich diese Referenz auf eine größere Anzahl von Antrieben bezieht, könnten geringfügige Änderungen bei Anbausätzen einiger Antriebe erforderlich sein  
 Comme cette référence couvre une très large gamme de servomoteurs, il se peut que le client pour quelques servomoteurs soit obligé d'adapter légèrement notre kit de montage

**Standard- und Sonder- Anbausätze, sortiert nach Hersteller / Typ des Antriebes**  
**Standard and specific attachment kits classify by manufacturer / type of actuator**  
**Kits de montage standard et spécifique par constructeurs / type de servomoteur**

Type / Version	Model Code of attachment kit	SRD998	RMU998-V	RMU998-W	SRD991 SRI990	SRD960	SRP981	SRI983	SR1986	SCE985 SMI983 SMP981
<b>NELES - METSO</b>										
Rotary actuators Type BJ and BC size 8 & 10 Mounting with feedback levers	EBZG-L1	•	•		•	•				
Type Ec and Ej	EBZG-L4	•	•		•	•				
Rotary actuators Type B1CU C/20 E	EBZG-L5	•	•		•	•				
Rotary actuators Type BJ and BC size 8 to 16 Mounting with direct rotary coupling	EBZG-L6	•	•		•	•				
Rotary actuators Type BJ and BC size 25 to 50 Mounting with original Neles's rotary coupling	EBZG-L7	•	•		•	•				
Rotary actuators BJ and BC6 Mounting with feedback levers	EBZG-L8	•	•		•	•				
<b>NORBRO (FLOWSERVE)</b>										
Schwenkantrieb / rotary actuator / servomoteur rotatif VDI/VDE 3845 => page 6 Anbaukonsole / Mounting bracket / console de montage VDI/VDE 3845 => page 14										
<b>NORGREN</b>										
(1) Cylinder Type RA/8100 (250 mm stroke) Others sizes please contact us	EBZG-X7	•	•		•	•				
<b>NUOVO PIGNONE (GE Power)</b>										
Same attachment kit than for Masoneilan 37/38										
<b>OMAL</b>										
Schwenkantrieb / rotary actuator / servomoteur rotatif VDI/VDE 3845 => page 6										
<b>ORBINOX</b>										
Knife gate valves	EBZG-B2	•			•	•				
<b>ORIGA</b>										
(1) Cylinder Type AZ5063 (300 mm stroke) Others sizes please contact us	EBZG-X6	•			•	•				
<b>PETRAS</b>										
In association with a special kit from Petras	EBZG-NN EBZG-R						•	•	•	•
<b>POLNA</b>										
Linear Type 37/38 size 9,11,13	EBZG-M6	•			•	•				
Linear Type 37/38 size 15, 18	EBZG-M2	•			•	•				
Linear Type P1/R1 with stroke < 80mm	EBZG-M4	•			•	•				
Linear Type P1/R1 with stroke > 80mm	EBZG-M4 + EBZG-B	•			•	•				
Linear Type P3/R3	EBZG-E				•					
Linear Type P/R	EBZG-E1	•				•				
Linear Type P/R	EBZG-K	•			•	•				
Rotary BR33 Series	EBZG-P3	•			•	•				

(1) Since this reference covers a wide range of actuators, the user might have to adapt certain attachment kits for some actuators slightly

Da sich diese Referenz auf eine größere Anzahl von Antrieben bezieht, könnten geringfügige Änderungen bei Anbausätzen einiger Antriebe erforderlich sein

Comme cette référence couvre une très large gamme de servomoteurs, il se peut que le client pour quelques servomoteurs soit obligé d'adapter légèrement notre kit de montage

**Standard- und Sonder- Anbausätze, sortiert nach Hersteller / Typ des Antriebes**  
**Standard and specific attachment kits classify by manufacturer / type of actuator**  
**Kits de montage standard et spécifique par constructeurs / type de servomoteur**

Type / Version	Model Code of attachment kit	SRD998	RMU998-V	RMU998-W	SRD991 SRI990	SRD960	SRP981	SRI983	SRI986	SGE985 SMI983 SMP981
<b>P + W (FLOWSERVE)</b>										
Plugvalve type BR33 in association with adaptation from P+W		Schwenkantrieb / rotary actuator / servomoteur rotatif VDI/VDE 3845 => page 6								
<b>REMOTE Control</b>										
		Schwenkantrieb / rotary actuator / servomoteur rotatif VDI/VDE 3845 => page 6								
<b>RESEARCH Control Valves (BADGER METER)</b>										
Series 9000	EBZG-H1	•			•	•				
Series 754 and 755 size 1/2"	EBZG-B1	•			•	•				
<b>ROTORK</b>										
Model GP 065 - GP 271	EBZG-B1	•			•	•				
<b>SAMSON</b>										
Type 271, 3271 (not valid for type 3271-5)	EBZG-H1	•			•	•				
	EBZG-GN						•	•		•
	EBZG-HN								•	
Mounting according the VDI/VDE3847 norm	EBZG-N1	•			•					
Typ 3277 (direct-mount. 1/4NPT) (not valid for type 3277-5)	EBZG-S1	•			•	Attachment kit without manometre				
	EBZG-S5				•	Attachment kit with manometre				
Typ 3277 (direct-mounting G1/4) (not valid for type 3277-5)	EBZG-S2	•			•	Attachment kit without manometre				
	EBZG-S6				•	Attachment kit with manometre				
Typ 3277-5 (direct-mounting) Old type with commutation plate fixed with 2 screws	EBZG-S8				•	Not for SRI990, not for SRD960				
Typ 3277-5 (direct-mounting) New type with commutation plate fixed with 1 screw	EBZG-S13				•	Not for SRI990, not for SRD960				
<b>SCHMIDT Armaturen (FLOWSERVE) - FOXBORO Control Valves - ECKARDT</b>										
Direct mounting	EBZG-D				•					
FoxTop / FoxPak (Flowserve)	EBZG-E				•					
	EBZG-E1	•				•				
<b>SCHLUMBERGER</b>										
Linear Actuator all size :										
Front Mounting	EBZG-S15	•			•	•				
	EBZG-S15N						•	•		
Side Mounting	EBZG-S16	•			•	•				
<b>SCHUBERT &amp; SALZER</b>										
	EBZG-FN						•	•		•
	EBZG-KN								•	
	EBZG-K1	•			•	•				
<b>SEREG (FLOWSERVE)</b>										
Maxflo "old type"	EBZG-S7	•			•	•	<- Maxflo first generation produced till 1983			
Maxflo Actuator NR, CNR "new"	EBZG-S4	•			•	•	<- Only if actuator is prepared for mounting of positioner!			
Maxflo Actuator NR1	EBZG-S4 + BHX426232132	•			•	•				
Maxflo Actuator NR1	EBZG-SB + BHX426232132						•	•	•	•
Maxflo Actuator NR2	EBZG-S4 + BHX426232141	•			•	•				
Maxflo Actuator NR2	EBZG-SB + BHX426232141						•	•	•	•
Maxflo Actuator NR3	EBZG-S4 + BHX426232152	•			•	•				
Maxflo Actuator NR3	EBZG-SB + BHX426232152						•	•	•	•
Maxflo Actuator NR3/NR2/NR1	EBZG-SB						•	•	•	•
							Only if actuator is prepared for mounting of positioner!			
Maxflo Actuator NX1	EBZG-S9	•	•		•	•				
Maxflo Actuator NX2	EBZG-S10	•	•		•	•				
Maxflo Actuator NX3	EBZG-S11	•	•		•	•				
Sereg Flowserve NL4	EBZG-S14	•	•		•	•				

**Standard- und Sonder- Anbausätze, sortiert nach Hersteller / Typ des Antriebes**  
**Standard and specific attachment kits classify by manufacturer / type of actuator**  
**Kits de montage standard et spécifique par constructeurs / type de servomoteur**

Type / Version	Model Code of attachment kit	SRD998	RMU998-V	RMU998-W	SRD991 SRI990	SRD980	SRP981	SRI983	SRI986	SGE985 SMI983 SMP981
<b>SIEMENS</b>										
V series	EBZG-S3	•			•	•				
<b>SOMAS</b>										
Rotary Actuator Type A	Schwenkantrieb / rotary actuator / servomoteur rotatif VDI/VDE 3845 => page 6									
<b>STAR LINE</b>										
All Rotary actuators	Schwenkantrieb / rotary actuator / servomoteur rotatif VDI/VDE 3845 => page 6									
<b>TURFLIN (XOMOX)</b>										
Model MX60	EBZG-T1	•			•	•				
Model MX200	EBZG-T2	•			•	•				
Model MX450, MX750, MX1250	EBZG-T3	•			•	•				
Model MX3000	EBZG-T4	•			•	•				
<b>UHDE (SHANZI Project)</b>										
Specific Application	EBZG-U1	•			•	•				
<b>VALTEK (FLOWSERVE)</b>										
(1) Linear actuators all size with stroke < and = 4 inch	EBZG-V1	•			•	•				
(1) Linear actuators size 200 and 300 with stroke 6 and 8 inch	EBZG-V4	•			•	•				
(1) Linear actuators size 200 with stroke 12 inch	EBZG-V5	•			•	•				
<b>VELAN</b>										
	EBZG-XN						•		•	
<b>VETEC</b>										
Actuator R Series all sizes	EBZG-V2	•	•		•	•				
<b>VH-Armaturen</b>										
	Schwenkantrieb / rotary actuator / servomoteur rotatif VDI/VDE 3845 => page 6									
<b>WEHLAN</b>										
	Schwenkantrieb / rotary actuator / servomoteur rotatif VDI/VDE 3845 => page 6									
<b>WORCESTER</b>										
Series 39	EBZG-W1	•			•					
<b>WYECO - TRACO Control Valves</b>										
Diaphragm actuator type D	EBZG-GN						•	•		•
	EBZG-HN								•	
	EBZG-H1	•			•	•				
<b>XOMOX mit EL-O-MATIC</b>										
	Schwenkantrieb / rotary actuator / servomoteur rotatif VDI/VDE 3845 => page 6									

- (1) Since this reference covers a wide range of actuators, the user might have to adapt certain attachment kits for some actuators slightly  
 Da sich diese Referenz auf eine größere Anzahl von Antrieben bezieht, könnten geringfügige Änderungen bei Anbausätzen einiger Antriebe erforderlich sein  
 Comme cette référence couvre une très large gamme de servomoteurs, il se peut que le client pour quelques servomoteurs soit obligé d'adapter légèrement notre kit de montage

**Auswahlhilfe für Anbaukonsolen einiger Hersteller**  
**Help to select the mounting bracket for some manufacturer**  
**Aide au choix de console de montage pour certains constructeurs**

**AIR TORQUE**

Antriebsgröße actuator size taille de servomoteur	Ritzelüberstand / Height of nob B	Bohrbild / Fixings Ax...	Anbaukonsolen / brackets / consoles de montage			
			EBZG-C1 A=80, B=20	EBZG-C2 A=80, B=30	EBZG-C3 A=130, B=50	EBZG-C4 A=130, B=30
DR/SC 15, 30, 60, 100, 150	20	80x30	●			
DR/SC 220, 300, 450, 600	30	80x30		●		
DR/SC 900, 1200, 2000, 3000	50	130x30			●	

**AMG**

Antriebsgröße actuator size taille de servomoteur	Ritzelüberstand / Height of nob B	Bohrbild / Fixings Ax...	Anbaukonsolen / brackets / consoles de montage			
			EBZG-C1 A=80, B=20	EBZG-C2 A=80, B=30	EBZG-C3 A=130, B=50	EBZG-C4 A=130, B=30
005	11	50x20				
010, 020, 025, 030, 033, 035, 040, 042	20	80x30	●			
045, 050	30	130x30				●

**Bar**

Antriebsgröße actuator size taille de servomoteur	Ritzelüberstand / Height of nob B	Bohrbild / Fixings Ax...	Anbaukonsolen / brackets / consoles de montage			
			EBZG-C1 A=80, B=20	EBZG-C2 A=80, B=30	EBZG-C3 A=130, B=50	EBZG-C4 A=130, B=30
GTD/GTE-046, -056, -066, -076, -086, -096, -110, -115, -127	30	80x30		●		
GTD/GTE-143, -163, -185, -210, -250, -254, -300	30	130x30				●

**EL-O-MATIC**

Antriebsgröße actuator size taille de servomoteur	Ritzelüberstand / Height of nob B	Bohrbild / Fixings Ax...	Anbaukonsolen / brackets / consoles de montage			
			EBZG-C1 A=80, B=20	EBZG-C2 A=80, B=30	EBZG-C3 A=130, B=50	EBZG-C4 A=130, B=30
ED/ES 12	20	40x31				
ED/ES 25, 40, 65, 100, 200, 350	20	80x30	●			
ED/ES 600, 950, 1600, 2500, 4000	30	130x30				●

**Auswahlhilfe für Anbaukonsolen einiger Hersteller**  
**Help to select the mounting bracket for some manufacturer**  
**Aide au choix de console de montage pour certains constructeurs**

**NORBRO**

Antriebsgröße actuator size taille de servomoteur	Ritzelüberstand / Height of nob B	Bohrbild / Fixings Ax...	Anbaukonsolen / brackets / consoles de montage			
			EBZG-C1 A=80, B=20	EBZG-C2 A=80, B=30	EBZG-C3 A=130, B=50	EBZG-C4 A=130, B=30
05 AR/BR 40	13	Dm. 36				
10, 15, 20 AR/BR 40	20	80x30	●			
25, 30, 33, 35 AR/BR 40	30	80x30		●		
40, 42, 45, 50 AR/BR 40	50	130x30			●	

**Keystone (Tyco)**

Antriebsgröße actuator size taille de servomoteur	Ritzelüberstand / Height of nob B	Bohrbild / Fixings Ax...	Anbaukonsolen / brackets / consoles de montage			
			EBZG-C1 A=80, B=20	EBZG-C2 A=80, B=30	EBZG-C3 A=130, B=50	EBZG-C4 A=130, B=30
79D Models 002, 003, 006, 036	20	80x30	●			
79U/E Models 002, 003, 036	20	80x30	●			
79U/E/D Models 065, 090, 180	30	130x30				●
Models 002 to 036	20		●			
Models 065, 180	30					●

NECESSARY MEASUREMENTS FOR THE DETERMINATION OF ATTACHMENT KIT FOR LINEAR ACTUATORS

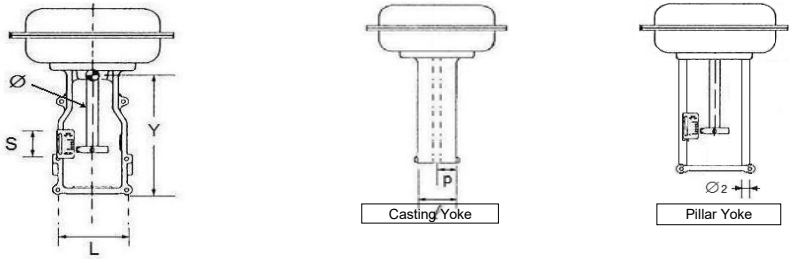

(dimensions in mm)										EXISTING HOLES			
Tag N°	Supplier	Model	S	L	Y	Ø	o	P	Ø2	CARRIER BOLT	FRONT VIEW	LEFT	RIGHT
PV803	Masoneilan	?	30	120	150	30	80	40	/				

Mesures nécessaires au développement d'un nouveau kit de montage  
 Necessary measurements to develop a new attachment kit  
 Notwendige Messungen um ein neues Anbausatz zu entwickeln