

FITOK Concised Product Catalog

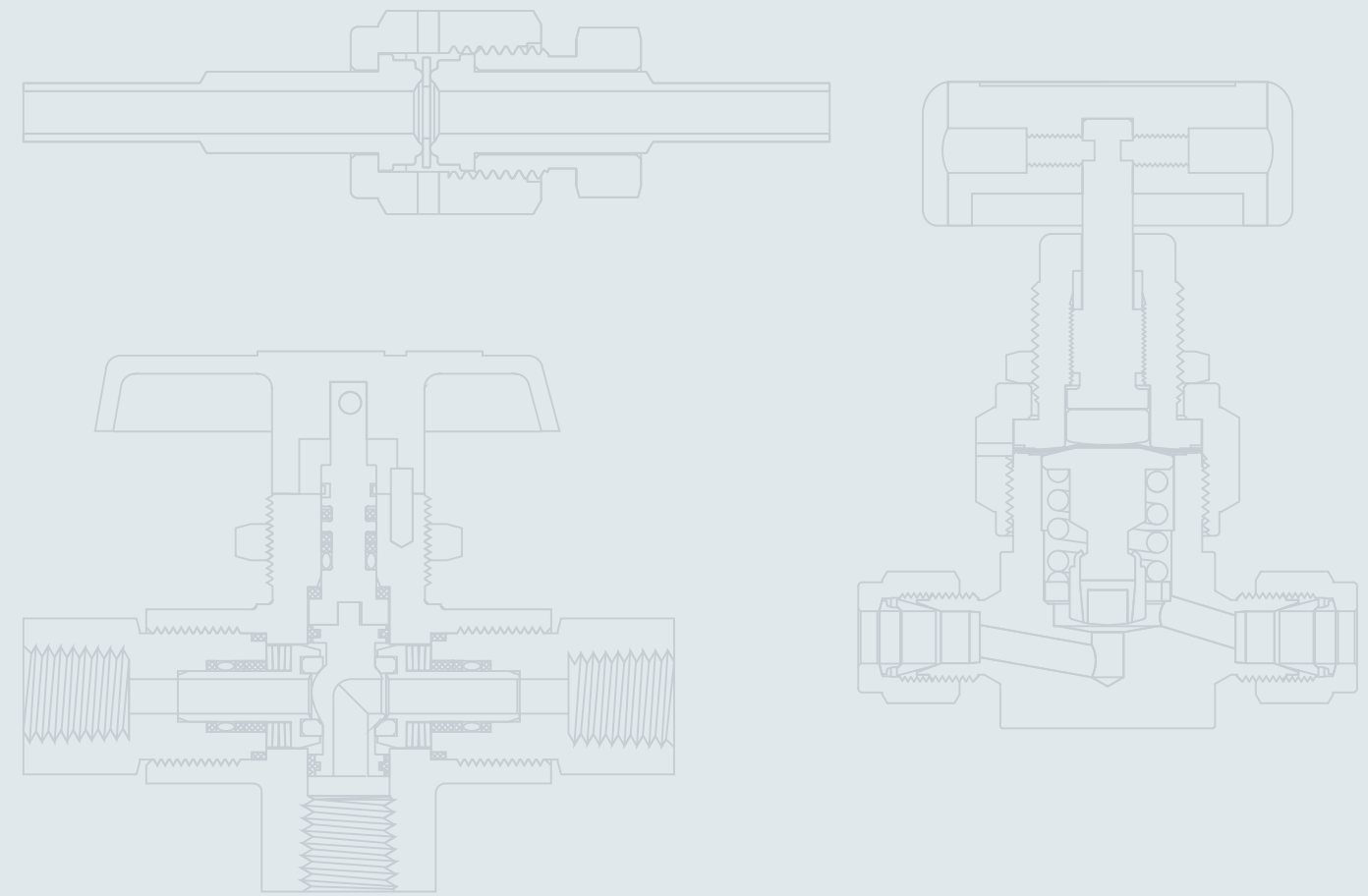

FITOK

Valves and Fittings

FITOK Group

FITOK GmbH (Headquarter)
 Spremlinger Landstr. 115, 63069 Offenbach am Main, Germany
 Tel.: +49 69 8900 4498 Fax: +49 69 8900 4495

FITOK, Inc.
 13843 North Promenade Blvd., Suite 750, Stafford, Texas 77477, USA
 Tel.: +1 281 888 0077 Fax: +1 281 582 4051

FITOK Incorporated
 1-4F, Block C, Zone E, Yingtailong Industrial Park, Dalang Street,
 Longhua District, Shenzhen, 518109, China
 Tel.: +86 755 2803 2500 Fax: +86 755 2803 2619

FITOK Middle East Oil Equipment Trading LLC
 208-209, Makateb Tower, Airport Road, P.O.Box 185412, Deira, Dubai, UAE
 Tel.: +971 4 2959 853 Fax: +971 4 2959 854

info@fitokgroup.com
 www.fitokgroup.com

Distributed by:

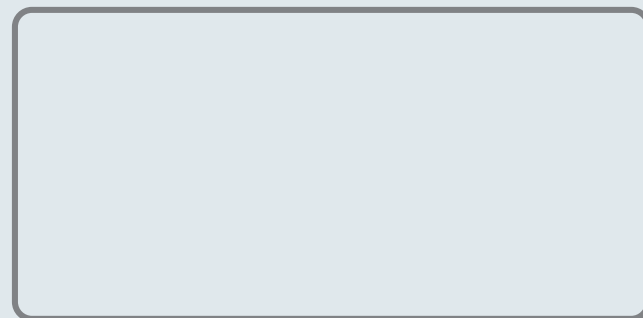

FK-CC-01-EN-151116

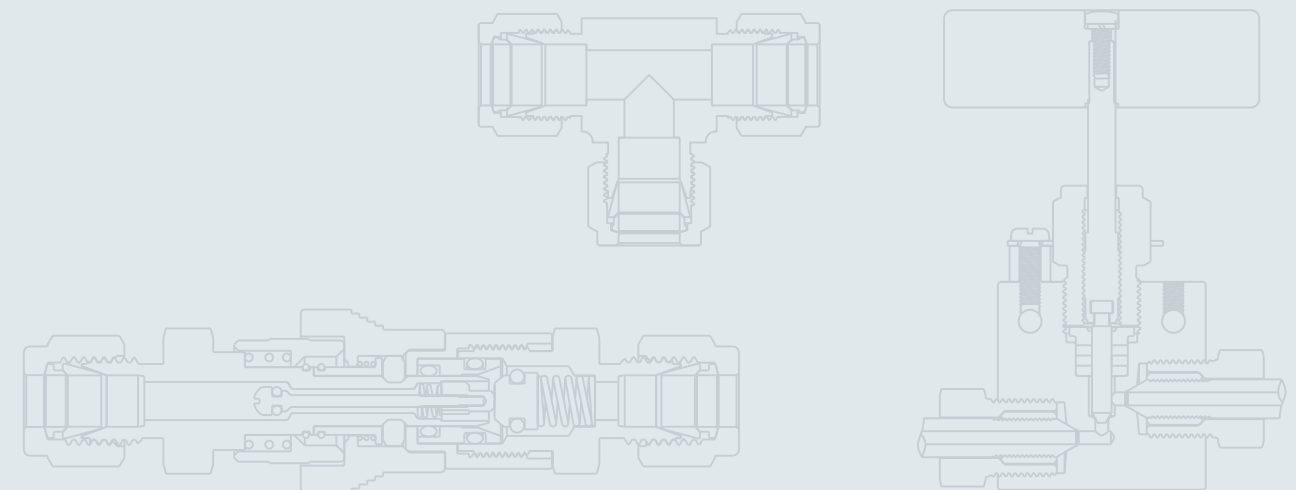

Contents

General Instrumentation Valves and Fittings

1	Fittings	6 Series Tube Fittings	1
		37° Flared Tube Fittings	5
		6 Series Pipe Fittings	8
		6 Series Weld Fittings	11
		Calibration Hoses and Fittings	14
		VL Series Vacuum Tube Fittings	18
		VA Series Vacuum Adapter Fittings	19
22	Valves	Ball Valves	21
		Bleed Valves	25
		Check Valves	26
		Excess Flow Valves	29
		Purge Valves	30
		Relief Valves	31
		Bellows-sealed Valves	34
		Metering Valves	36
		Needle Valves	38
		Plug Valves	42
		Two-Piece Forged Metal-Seated Ball Valves	43
		Globe Valves	44
44	Manifolds	Air Headers and Distribution Manifolds	46
		Block and Bleed Valves	50
		Gauge Valves	57
		Instrumentation Manifolds	59
64	Filters		
67	Hoses and Connectors		
71	Quick-connects		
73	Condensate Pots and Vessels		
75	Sample Cylinders and Accessories		
77	Tubing Tools		
79	Other Elements		

Medium & High Pressure Valves and Fittings

86	High Pressure Fittings	15 Series Tube Fittings	84
		20 Series Tube Fittings	87
		60 Series Tube Fittings	88
		Pipe Fittings	90
		Adapters and Couplings	93
100	High Pressure Valves	Needle Valves	98
		Ball Valves	101
		Check Valves	103
		Metering Valves	105
		Relief Valves	106
108	Line Filters		
110	Medium & High Pressure Tubings		
111	Tools		

Semiconductor & Specialty Gas Applications







113	Fittings	Butt Weld Fittings	113
		Metal Gasket Face Seal Fittings	115
		O-ring Face Seal Fittings	109
		L-ring Face Seal Fittings	121
122	Valves	Diaphragm Valves	122
		Pressure Reducing Regulator	128
		Back Pressure Regulator	132
134	Changeover System		
136	Closed-loop Sampling System		

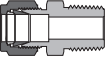
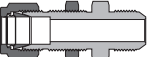

Fittings

6 Series Tube Fittings

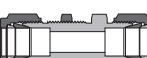

- Sizes range from 1/16" to 2" and 2 mm to 50 mm.
- Diverse materials and configurations are available.
- Precision machined components ensure perfect deformation of the ferrules and tubing.
- Hardened threads and smoothed surface finishes extend fitting life and prevent sticking of the matching threads.
- Female nut threads are silver-plated to minimize the friction with body threads.
- Radius junction design within elbows provides smooth flow path.
- Every fitting is stamped with size, material, and heat code.
- Fittings are easy to disconnect and retighten.

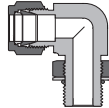
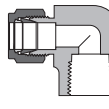
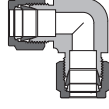
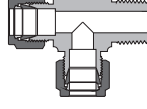
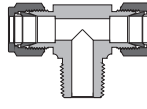
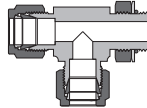
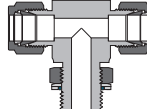
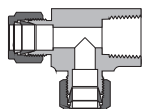
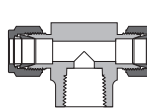
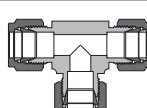
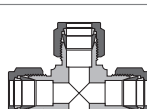
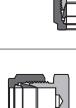
Configuration	Fitting Type	Example
	Male Connector	SS-CM-ML12-NS8
	Bulkhead Male Connector	S4-BCM-FL8-AN8
	Thermocouple Connector	S1-TCM-FL8-NS8
	Female Connector	B-CF-FL8-RG6
	Bulkhead Female Connector	CS-BCF-ML12-NS8
	Union	M-U-FL12
	Bulkhead Union	HC-BU-ML10
	Male Elbow	T-LM-FL8-NS8

Configuration	Fitting Type	Example
	Positionable Male Elbow	TI-LP-ML14-ST14
	Female Elbow	PA-LF-FL8-NS8
	Union Elbow	INC-LU-FL8
	Male Run Tee	A20-TMT-FL8-NS8
	Male Branch Tee	D5-TTM-ML16-NS8
	Positionable Male Run Tee	AL-TPT-FL8-ST14
	Positionable Male Branch Tee	A65-TTP-FL8-PP8
	Female Run Tee	SS-TFT-FL8-NS8
	Female Branch Tee	SS-TTF-ML12-NS8
	Union Tee	SS-TTT-FL6
	Union Cross	SS-C-FL8
	Cap	SS-TC-FL8
	Plug	SS-TP-ML12
	Nut+Ferrules	SS-NFR-FL8

Configuration	Fitting Type	Example
	Reducer	SS-R-FL8-MT12
	Insert for Soft Plastic Tubing	SS-IN-8-6
	Port Connector	SS-P-FL4
	Male Adapter	SS-AM-FT8-RT8
	Female Adapter	SS-AF-MT12-NS8
	Flange Adapter	SS-FA-FL6-F8-300
	Weld Connector	SS-CW-FL8-TS8
	Weld Elbow	SS-LW-FL8-PB8
	Lapped Flange Connector	SS-LFC-FL6A
	Calibration Fitting	SS-FC-FL4-1428
	Dielectric Fitting	SS-DF-FL6
	Nut-Ferrule Set	SS-NFS-FL6
	Ferrule Set	SS-FRS-FL6
	45° Male Elbow	SS-VM-FL5-NS2
	45° Adjustable Male Elbow	SS-VP-FL16-ST21
	Vent Protector	SS-VPF-NS12
	Fusible Fittings	SS-GFTA-4-160

Part Number Description

SS - CM - ML12 - NS8 - □ - □ - □ - □

Material	Fitting Type	P1 Type	P1 Size	P2 Type	P2 Size	P3 and P4	Cleaning and Packaging
SS 316 SS	CM Male Connector	ML Metric Ferrule	1 1/16"	Except the same as the P1, the other type follows: NS NPT Thread ONS O-ring with NPT Thread RT ISO Tapered Thread RS ISO Parallel Thread RP ISO Parallel Thread RG ISO Parallel Thread (Gauge) RJ ISO Parallel Thread (Japanese Gauge) PP Positionable, ISO Parallel Thread ST SAE/MS Straight Thread OST O-ring with SAE/MS Straight Thread AN 37° Flare MS Male Metric Thread TS Fractional Tube Socket Weld PB Pipe Butt Weld	Except the same as the P1, the other size follows: 5 M5 x 0.8 or 5/16-24 6 M6 x 1 or 3/8-24 7 7/16-20 8 M8 x 1 or 1/2-20 9 9/16-18 10 M10 x 1 12 M12 x 1.5 or 3/4-16 14 M14 x 1.5 or 7/8-14 16 M16 x 1.5 17 1 1/16-12 18 M18 x 1.5 19 1 3/16-12 20 M20 x 1.5 21 5/16-12 22 M22 x 1.5 24 M24 x 1.5 26 1 5/8-12 27 M27 x 2 30 1 7/8-12	Specify in the same way as the P2	FC-01 FC-02 F2
S4 304 SS	BCM Bulkhead Male Connector	FL Fractional Ferrule	2 1/8" or 2 mm				
S1 321 SS	TCM Thermocouple Connector	MT Metric Tube	3 3/16" or 3 mm				
904L 904L SS	CF Female Connector	FT Fractional Tube	4 1/4" or 4 mm				
TI Titanium	BCF Bulkhead Female Connector		5 5/16"				
D5 Duplex 2205	U Union		6 3/8" or 6 mm				
D7 Duplex 2507	BU Bulkhead Union		8 1/2" or 8 mm				
A20 Alloy 20	LM Male Elbow		10 5/8" or 10 mm				
M Alloy 400	VM 45° Male Elbow		12 3/4" or 12 mm				
INC Alloy 600	VP 45° Adjustable Male Elbow		14 7/8" or 14 mm				
A65 Alloy 625	LP Positionable Male Elbow		15 15 mm				
HC Alloy C-276	LF Female Elbow		16 1" or 16 mm				
CS Carbon Steel	LU Union Elbow		18 1 1/8" or 18 mm				
AL Aluminum	BBLU Bulkhead Union Elbows		20 1 1/4" or 20 mm				
B Brass	TMT Male Run Tee		22 22 mm				
PA Nylon	TTM Male Branch Tee		24 1 1/2" or 24 mm				
T PTFE	TPT Positionable Male Run Tee		25 25 mm				
	TTP Positionable Male Branch Tee		28 28 mm				
	TFT Female Run Tee		30 30 mm				
	TTF Female Branch Tee		32 2" or 32 mm				
	TTT Union Tee		38 38 mm				
	C Union Cross		50 50 mm				
	TC Cap						
	TP Plug						
	R Reducer						
	P Port Connector						
	AM Male Adapter						
	AF Female Adapter						
	CW Weld Connector						
	LW Weld Elbow						
	DF Dielectric Fitting						

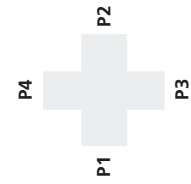

P1, P2, P3 and P4 shall be described in the following orders:







- Ferrule - Tube - NPT Thread - ISO Tapered Thread - ISO Parallel Thread - SAE/MS Straight Thread - 37° Flare - Pipe Butt Weld - Fractional Tube Socket Weld - Others
- Describe in descending order as per size if the end connection types are the same
- Describe the end of P1 if all end connections are the same **Cleaning and Packaging:**
FC-01: Standard cleaning and packaging for general industrial procedures
FC-02: Special cleaning and packaging for wetted system components to ensure compliance with product cleanliness requirement as stated in ASTM G93 Level C

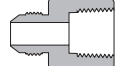
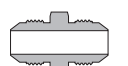
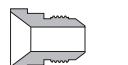

Note: "Part Number Description" is used for composition rules of FITOK product model, Not suitable for specific product part number selection, not random combinations. If in doubt, please contact FITOK group or authorized agent.

37° Flared Tube Fittings

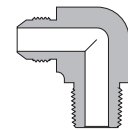
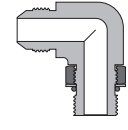
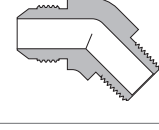
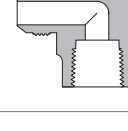

- Fittings are designed and manufactured in compliance with SAE J514.
- Sizes range from 1/8" to 2" and 3 mm to 50 mm.
- 316 stainless steel, aluminum, brass, and carbon steel materials are available.
- Hardened threads and smoothed surface finishes extend fitting life and prevent sticking of the matching threads.
- Radius junction design within elbows provides smooth flow path.
- Every fitting is stamped with size, material and heat code.
- Female nut threads are silver-plated to minimize the friction with body threads.
- Fittings are easy to disconnect and retighten.

Configuration	Fitting Type	Example
	Sleeve	SS-SL-AN8
	Nut	AL-N-AN8
	Male Connector	B-CM-AN8-NS8
	Female Connector	CS-CF-AN8-RT6
	Union	SS-U-AN8
	Reducing Adapter	SS-RA-AN8-AN4
	Bulkhead Union	SS-BU-AN6
	Tube Plug	SS-TP-AN6
	Tube Cap	SS-TC-AN6

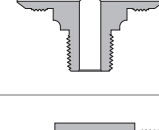
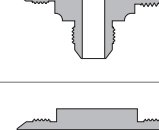
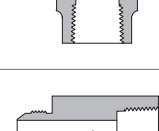
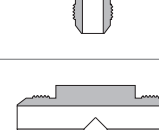
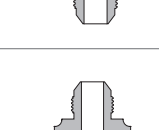
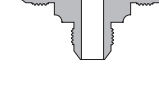
Configuration	Fitting Type	Example
	Male Elbow	SS-LM-AN8-NS4
	Positionable Male Elbow	SS-LP-AN10-ST14
	45° Male Elbow	SS-VM-AN8-NS6
	Female Elbow	SS-LF-AN8-NS6
	Union Elbow	SS-LU-AN4
	Male Branch Tee	SS-TTM-AN8-NS4
	Male Run Tee	SS-TMT-AN8-RT4
	Female Branch Tee	SS-TTF-AN8-RT4
	Female Run Tee	SS-TFT-AN8-NS4
	Union Tee	SS-TTT-AN8
	Union Cross	SS-C-AN12

Part Number Description

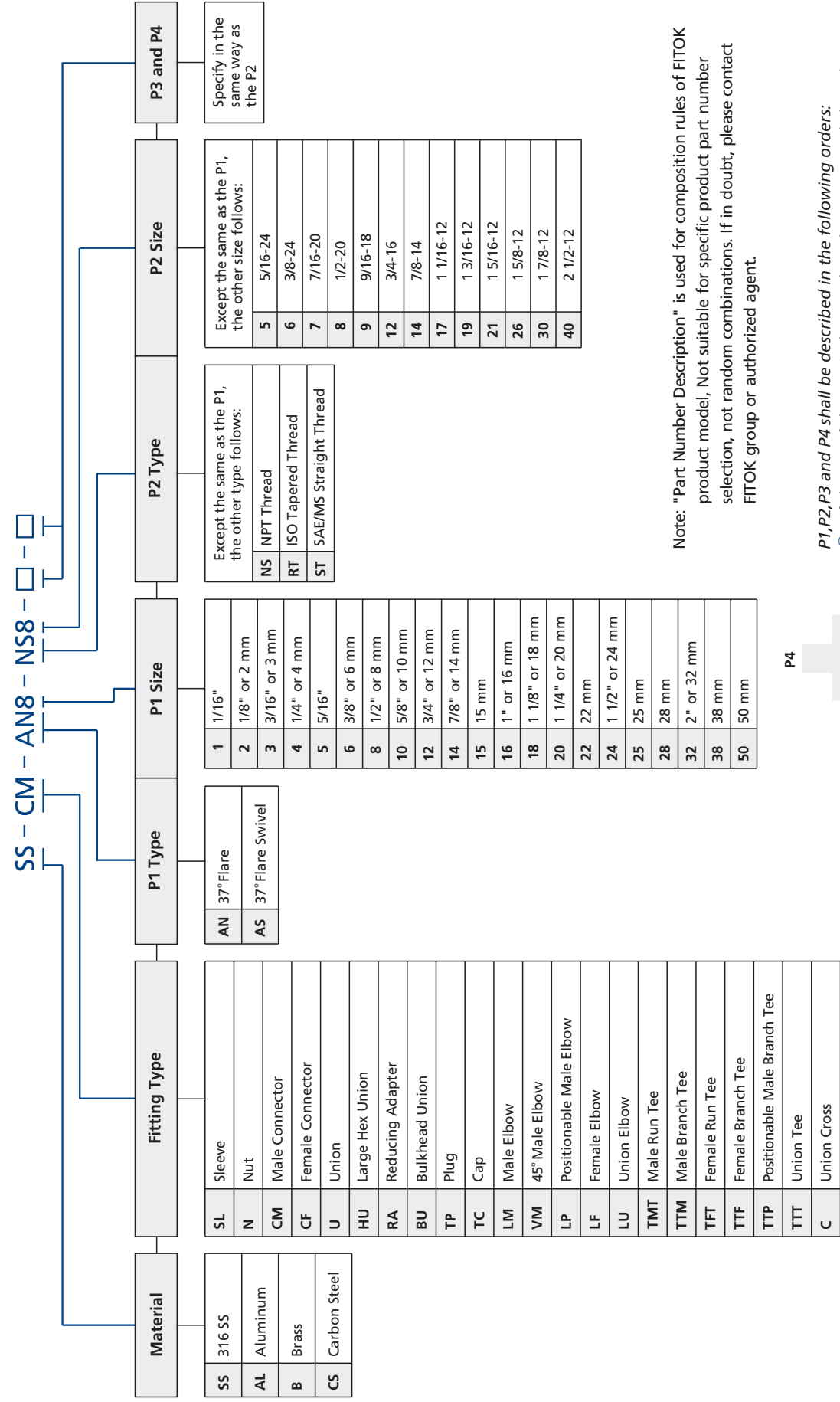

6 Series Pipe Fittings



- Sizes range from 1/16 to 2.
- Materials include stainless steel, alloy 400, alloy 600, brass, and carbon steel.
- End connections with NPT, ISO/BSP, SAE, and metric threads are available.
- Hardened threads and smoothed surface finishes extend fitting life and prevent sticking of the matching threads.
- Radius junction design within elbows provides smooth flow path.
- Every fitting is stamped with size, materia, and heat code.

Configuration	Fitting Type	Example
	Pipe Plug	SS-PP-MRS14
	Hollow Hex Plug	S4-PI-NS4
	Close Nipple	S1-PCN-RT6
	Special Pipe Nipple	M-PSN-NS6-50.8
	Hex Nipple	INC-PHN-NS8-RP8
	Hex Long Nipple	B-PLN-NS6-76.2
	Reducing Bushing	CS-PRB-NS8-RT4
	Pipe Cap	SS-PC-NS4
	Hex Coupling	SS-PCG-NS12-NS8
	Union Ball Joint	SS-UBJ-NS4

Configuration	Fitting Type	Example
	Adapter	SS-PA-NS8-ST12
	Male Elbow	SS-PME-NS6
	Street Elbow	SS-PSE-RT6-RT4
	45° Street Elbow	SS-PSV-NS6-NS4
	Female Elbow	SS-PE-NS6
	45° Female Elbow	SS-PVE-NS6
	Male Tee	SS-PMT-NS4
	Female Branch Tee	SS-PTB-NS6
	Female Run Tee	SS-PTR-RT6
	Male Street Tee	SS-PST-NS6
	Male Branch Tee	SS-PBT-NS6
	Female Tee	SS-PT-RT8
	Female Cross	SS-PCR-NS6
	Pipe to Pipe Union	SS-PUP-MS20-NS4
	Hand Tight Adapter Fitting	SS-HF-MS20-FMS20
	Fusible Fittings	SS-GFPP-4-160

Part Number Description

SS – PSE – NS6 – NS4 – □ – □ – □ – S – □

Material	Fitting Type	P1 Type	P1 Size	P2, P3 and P4	Special Application	Cleaning and Packaging							
SS	PP	NS	2	Specify in the same way as the P1	<table border="1"> <tr> <td>NO</td> <td rowspan="2">Classification for Nuclear Facility Application</td> </tr> <tr> <td>S</td> </tr> <tr> <td>N2</td> <td>Class 2</td> </tr> <tr> <td>N3</td> <td>Class 3</td> </tr> </table>	NO	Classification for Nuclear Facility Application	S	N2	Class 2	N3	Class 3	FC-01
NO	Classification for Nuclear Facility Application												
S													
N2	Class 2												
N3	Class 3												
S4	PI	RT	4				<ul style="list-style-type: none"> ○ NPT Thread - ISO Tapered Thread - ISO Parallel Thread - SAE/MS Straight Thread - Metric Thread - Others ○ Male after female but the "PRB" and the "HF" types are not included ○ Describe in descending order as per size if the end connection types are the same ○ Describe the end of P1 if all end connections are the same 	F2					
S1	PCN	RG	5					<p>Note: "Part Number Description" is used for composition rules of FITOK product model, Not suitable for specific product part number selection, not random combinations. If in doubt, please contact FITOK group or authorized agent.</p>	<p>Cleaning and Packaging:</p> <p>FC-01: Standard cleaning and packaging for general industrial procedures</p> <p>FC-02: Special cleaning and packaging for wetted system components to ensure compliance with product cleanliness requirement as stated in ASTM G93 Level C</p>				
M	PSN	BP	6										
INC	PHN	RS	7										
HC	PLN	MRS	8										
B	PRB	MS	9										
CS	PC	ST	10										
904L	PCG	US	12										
	UBJ		14										
	PA		16										
	PME		17										
	PSE		18										
	PSV		19										
	PE		20										
	PVE		21										
	PMT		22										
	PTB		24										
	PTR		26										
	PST		27										
	PBT		30										
	PT		32										
	PCR												
	PUP												
	HF												

6 Series Weld Fittings



- ⦿ Sizes range from 1/8" to 2" and 6 mm to 38 mm.
- ⦿ 316 stainless steel material is standard; other materials are available on request.
- ⦿ Radius junction design within elbows provides smooth flow path.
- ⦿ Maximum working temperature is 1000°F (538°C).
- ⦿ Every fitting is stamped with size, material, and heat code.

Configuration	Fitting Type	Example
	Tube Butt Weld Male Connector	SS-WM-TB12-NS8
	Tube Butt Weld Female Connector	SS-WF-MTB14-NS8
	Tube Butt Weld Reducing Union	SS-WU-MTB20-MTB14
	Tube Butt Weld Union Elbow	SS-WLU-TB8
	Tube Butt Weld Union Tee	SS-WT-MTB14
	Tube Butt Weld Union Cross	SS-WC-MTB12
	Tube Socket Weld Male Connector	SS-WM-TS8-NS8
	Tube Socket Weld Female Connector	SS-WF-MTS14-NS4
	Tube Socket Weld Male Elbow	SS-WLM-TS6-NS6
	Tube Socket Weld Female Elbow	SS-WLF-TS8-NS8

Configuration	Fitting Type	Example
	Tube Socket Weld Union	SS-WU-TS8
	Tube Socket Weld Reducing Union	SS-WU-TS12-TS8
	Tube Socket Weld Union Elbow	SS-WLU-MTS14
	Tube Socket Weld Union 45° Elbow	SS-WV-TS8
	Tube Socket Weld Union Tee	SS-WT-MTS14
	Tube Socket Weld Union Cross	SS-WC-TS8
	Pipe Butt Weld Male Connector	SS-WM-PB6-NS6
	Pipe Butt Weld Female Connector	SS-WF-PB8-NS8
	Pipe Socket Weld Male Connector	SS-WM-PS6-NS6
	Pipe Socket Weld Female Connector	SS-WF-PS8-NS8
	Pipe Socket Weld Union	SS-WU-PS8
	Tube to Tube Weld Adapter	SS-WA-TB8-TS6
	Pipe to Tube Weld Adapter	SS-WA-PB8-TS8
	Pipe to Weld End Union	SS-PUW-MS20-MTB14
	Male Pipe to Weld End Union	SS-MUW-NS8-MTB14

Part Number Description

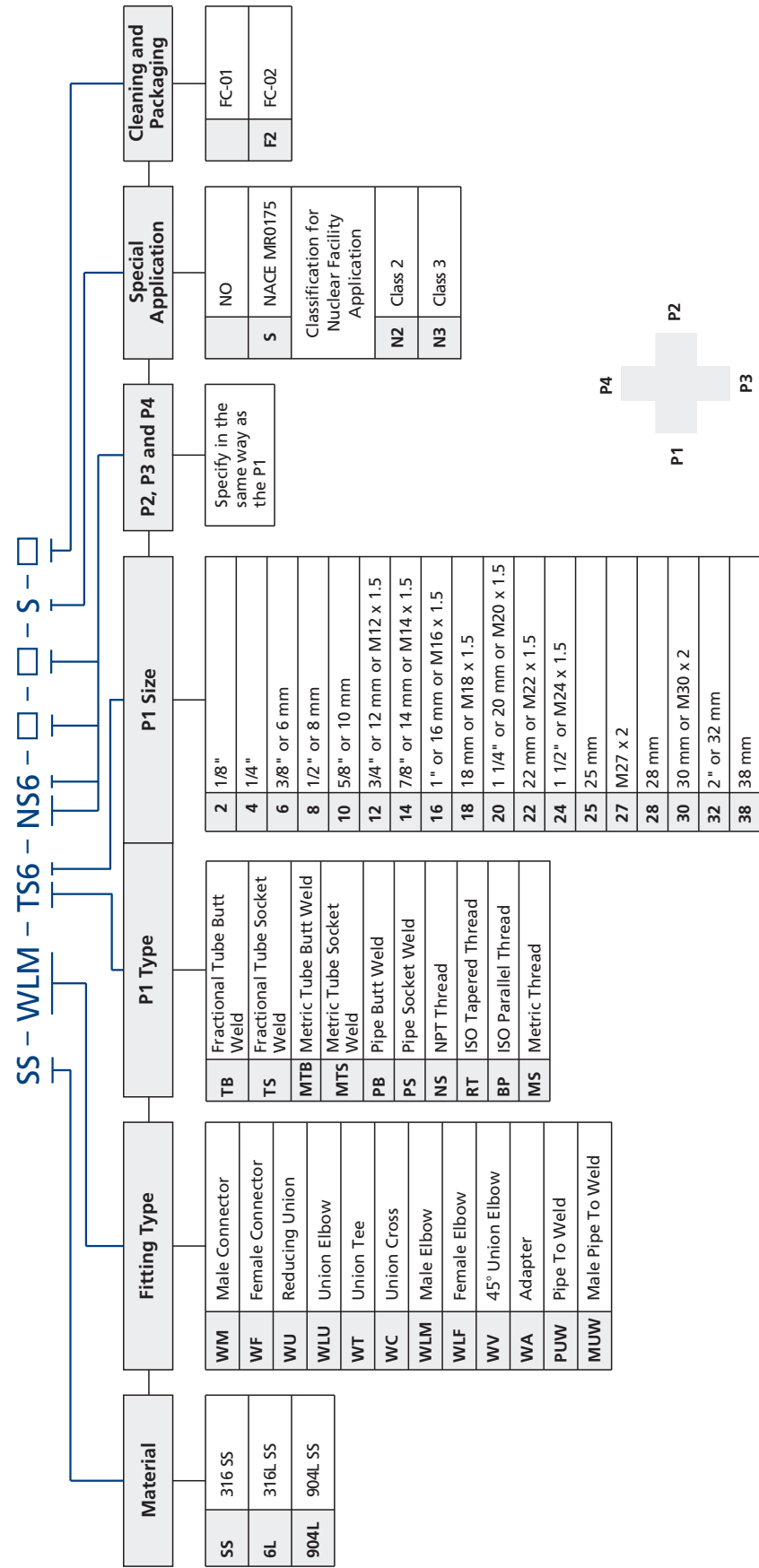

P1, P2, P3 and P4 shall be described in the following orders:

- Pipe thread connection type after weld connection type ("PUW" and "MUW" excluded)
- Pipe Butt Weld - Tube Butt Weld - Pipe Socket Weld - Tube Socket Weld - Others
- Describe in descending order as per size if the end connection types are the same
- Describe the end of P1 if all end connections are the same

Cleaning and Packaging:

FC-01: Standard cleaning and packaging for general industrial procedures
 FC-02: Special cleaning and packaging for wetted system components to ensure compliance with product cleanliness requirement as stated in ASTM G93 Level C

Note: "Part Number Description" is used for composition rules of FITOK product model, Not suitable for specific product part number selection, not random combinations. If in doubt, please contact FITOK group or authorized agent.

Calibration Hoses and Fittings

- Assembly and disassembly without requirement for a wrench or thread sealant
- Flexible hoses with small inside diameter and low internal volume
- Variety of adapters to connect with wide range of calibration devices
- Mix-interchangeable with other main brands
- Every assembly is factory tested with pure water at 1.5 times the maximum working pressure.



Quick-test Hoses

QH Series

- Working pressure up to: 6900 psig (475 bar)
- Working temperature: -10°F to 140°F (-23°C to 60°C)
- Hose outside diameter: 0.2" (5 mm)
- Hose inside diameter: 0.08" (2 mm)
- End connection materials: 316 SS, 304 SS

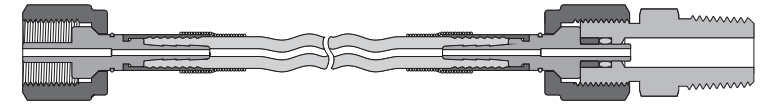

Hose Ends

FST End	1/2-20 UNF	NS2 End	1/8-27 NPT
SMS16x2 End	M16x2.0	NS4 End	1/4-18 NPT
SMS20 End	M20x1.5	FT2 End	1/8" Tube Adapter
FT4 End	1/4" Tube Adapter		

Types listed are standard. Other types are available upon request.

Part Number Description

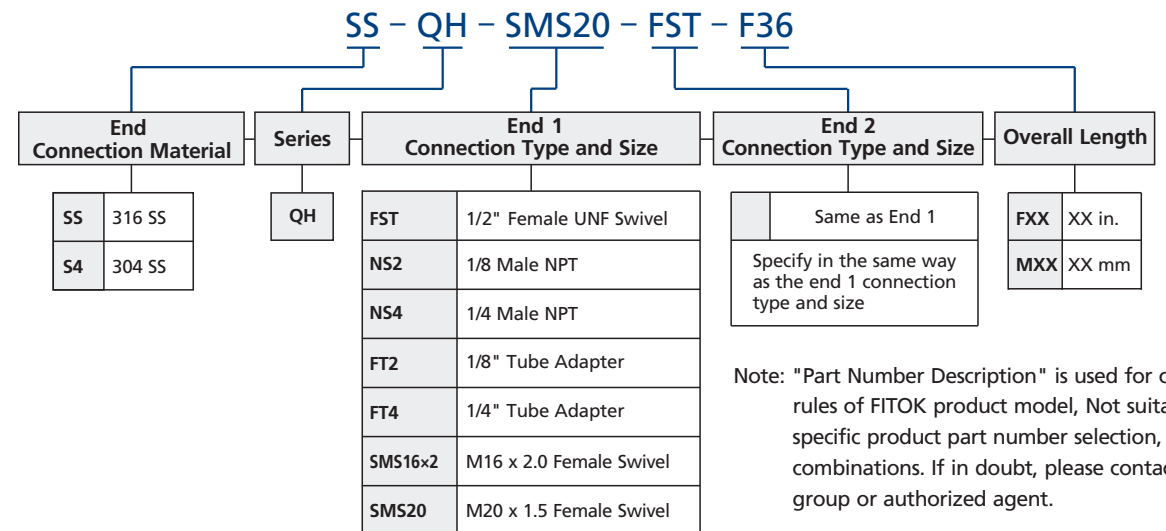









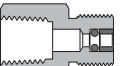

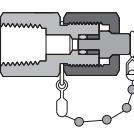

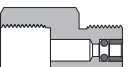
Note: "Part Number Description" is used for composition rules of FITOK product model, Not suitable for specific product part number selection, not random combinations. If in doubt, please contact FITOK group or authorized agent.

Quick-test Adapters and Fittings

QT Series

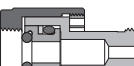
- Working pressure up to:
 - Without valve: 5000 psig (345 bar)
 - With valve: 3000 psig (207 bar)
- Working temperature:
 - Fluorocarbon FKM seal: -10°F to 400°F (-23°C to 204°C)
 - Buna N seal: -10°F to 250°F (-23°C to 121°C)
- Materials: 316 SS, 304 SS
- Optional check valves and protective caps available

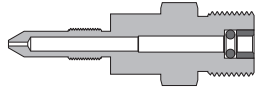
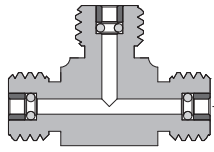
Configuration	Fitting Type	Example
	Male NPT Adapters	SS-QT-NS4-ST
	Female NPT Adapters	SS-QT-FNS4-ST
	Male BSPT Adapters, with valve	SS-QT-RT4-ST-V
	Female BSPT Adapters, with cap	SS-QT-FRT4-ST-PC
	Male BSPP Adapters	SS-QT-RS2-ST
	Female BSPP Adapters	SS-QT-RG4-ST
	Male NPT Quick-test Gauge Adapters	SS-QT-NS4-FST
	Female NPT Quick-test Gauge Adapters	SS-QT-FNS4-FST
	Female BSPP Quick-test Gauge Adapters	SS-QT-RG4-FST
	Quick-test Hose Unions	SS-QT-ST-ST
	Quick-test Tube Adapters	SS-QT-QL4-ST
	Hand Tight Female NPT Quick-test Gauge Adapters	SS-QT-QNS8-ST

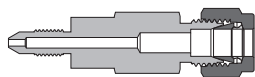
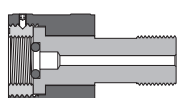
Configuration	Fitting Type	Example
	DP Transmitter Calibration Adapters	SS-QT-CH-ST
	Quick-test Tees	SS-QT-ST-ST-ST
	Male High Pressure Adapters	SS-QT-60HP-ST
	DP Transmitter Calibration Adapters	SS-QT-CH-FL4
	Hand Tight Adapters	SS-QT-MS20-MS14

High Pressure Quick-test Hose Assemblies

HQH Series

- Working pressure up to: 10000 psig (690 bar)
- Working temperature: -40°F to 140°F (-40°C to 60°C)
- Outer diameter of hose: 0.24" (6 mm)
- Inner diameter of hose: 0.08" (2 mm)
- Hose end materials: 316 SS, 304 SS
- Fluid media: water, petroleum based oils, air, inert gas



Part Number Description

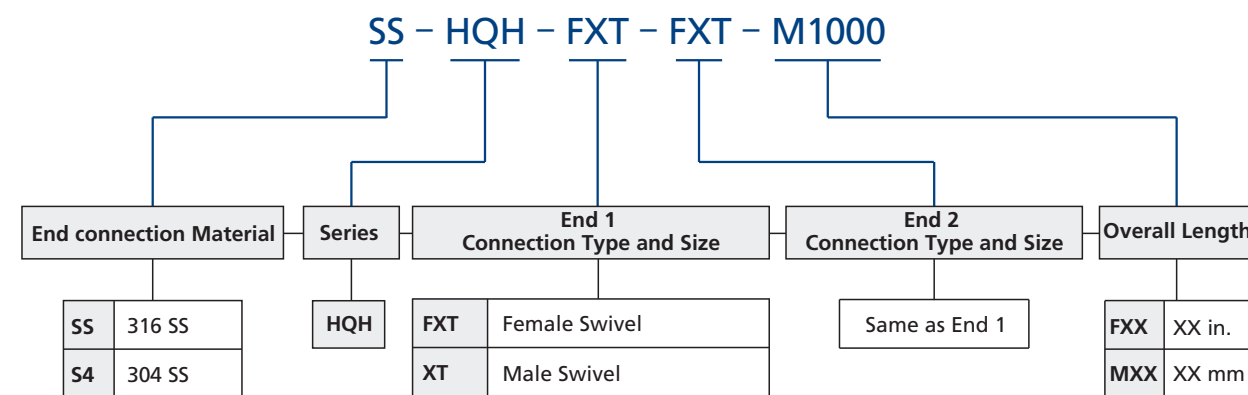

Note: "Part Number Description" is used for composition rules of FITOK product model, Not suitable for specific product part number selection, not random combinations. If in doubt, please contact FITOK group or authorized agent.

High Pressure Quick-test Fittings

HQT Series

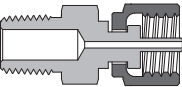
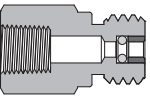
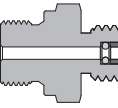
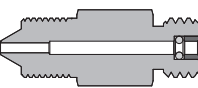
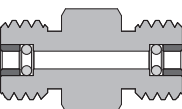
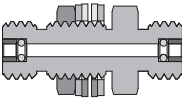
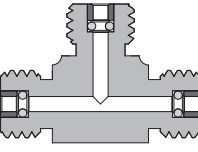

- Working pressure up to: 690 bar (10000 psig)
- Working temperature:
 - FKM Seal: -10°F to 400°F (-23°C to 204°C)
 - NBR Seal: -10°F to 250°F (-23°C to 121°C)
- Materials: 316 SS, 304 SS
- Convenient connection: No wrench or thread sealant required for assembly or disassembly.
- This kind of fittings is not applicable to use with FITOK QH series Quick-test Hose, please use with FITOK HQH series Quick-test Hose.

Configuration	Fitting Type	Example
	Male NPT Adapter	SS-HQT-NS4-XT
	Male NPT Quick-test Gauge Adapters	SS-HQT-NS4-FXT
	Female NPT Adapters	SS-HQT-FNS4-XT
	Male BSPP Adapters	SS-HQT-RS4-XT
	High Pressure Male Adapters	SS-HQT-60HP-XT
	Quick-test Unions	SS-HQT-XT-XT
	Quick-test Bulkhead Unions	SS-HQT-XT-TXT
	Quick-test Tees	SS-HQT-XT-XT-XT

VL Series Vacuum Tube Fittings

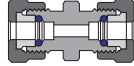
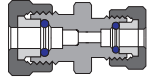
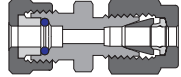
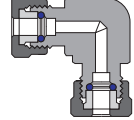
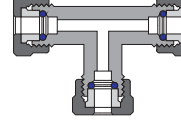
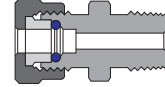
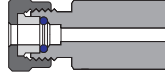
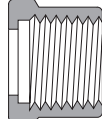

- Stainless steel construction, fluorocarbon FKM O-ring
- Available in tube sizes from 1/16" to 1 1/2"
- Working temperature: -25°F to 400°F (-31°C to 204°C)
- Knurled nut for easy, finger-tight assembly
- Reliable, repeatable sealing performance

Configuration	Fitting Type	Example
	Union	SS-U-VL8
	Reducing Union	SS-U-VL6-VL4
	Tube Fitting Union	SS-U-VL4-FL4
	Union Elbow	SS-LU-VL8
	Union Tee	SS-TTT-VL8
	Male Connector	SS-CM-VL8-NS6
	Adapter	SS-CW-VL4-A4
	Nut	SS-N-VL10
	O-ring	VI7-014

VA Series Vacuum Adapter Fittings

- Vacuum Range:
 - Copper Seal: $\geq 10^{-12}$ Torr
 - Elastomeric Seal: $\geq 10^{-8}$ Torr
- Working temperature:
 - Copper Seal: -325°F to 842°F (-200°C to 450°C)
 - Elastomeric Seal: -4°F to 302°F (-20°C to 150°C)
- Standard materials are in stainless steel 304, 304L, 316, 316L and Aluminum.



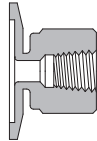
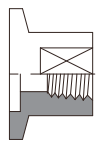
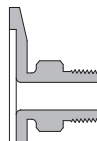
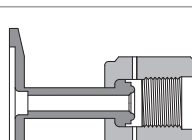
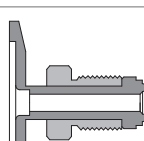
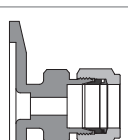
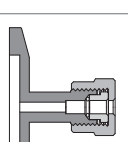

KF Adapter Fittings

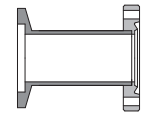
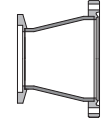
Configuration	Fitting Type	Example
 A Type (Default)	KF to Female NPT	S4-VA-KF10-FNS2
 B Type	KF to Female NPT	S4-VA-KF16-FNS2-N
	KF to Male NPT	S4-VA-KF10-NS2
	KF to Female FR Metal Gasket Face Seal Fitting	S4-VA-KF10-FFR4
	KF to Rotatable Male FR Metal Gasket Face Seal Fitting	S4-VA-KF10-RFR4
	KF to Tube Fitting	S4-VA-KF10-FL4
	KF to Vacuum Tube Fitting	S4-VA-KF25-VL4

Configuration	Fitting Type	Example
	KF to CF Flange Straight Reducing	S4-VA-KF10-CF133-SR
	KF to CF Flange Conical Reducing	S4-VA-KF16-CF212-NCR

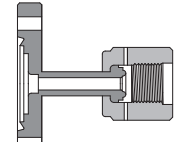
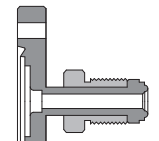
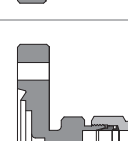
CF Adapter Fittings

Configuration	Fitting Type	Example
	CF to Female FR Metal Gasket Face Seal Fitting	S4-VA-CF133-FFR4
	CF to Rotatable Male FR Metal Gasket Face Seal Fitting	S4-VA-CF133-RFR4
	CF to Tube Fitting	S4-VA-CF133-FL4
	CF to Vacuum Tube Fitting	S4-VA-CF212-VL4

Other Adapter Fittings

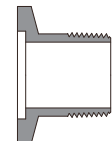
Configuration	Fitting Type	Example
	Male ISO Tapered Thread	S4-VA-KF10-RT4

Valves

Ball Valves



- Strong flowing capability and low operating torque
- 2-way Ball valves available for flow in two direction
- Symmetrical damping of operate, low operating torque and easy to operate
- Pneumatic or electric actuator available
- Options for handle color
- Every valve is factory tested with nitrogen at rated pressure; If rated pressure is greater than 6000 psig, tested at 6000 psig accordingly.

BF and BFH Series

- Forged body with end connectors
- Body materials: 316 SS, 316L SS, 904L SS, and alloy 400
- Seat materials: PTFE, PCTFE and PEEK
- Packing materials: fluorocarbon FKM and PTFE
- End connections:
 - 1/8 to 1/2 female NPT
 - 1/4" to 1/2" and 6 mm to 12 mm tube fitting
- Orifice size: 0.19" (4.8 mm)
- Working pressure up to:
 - BF Series: 6000 psig (414 bar)
 - BFH Series: 10 000 psig (690 bar)
- Working temperature: 0°F to 450°F (-18°C to 232°C)

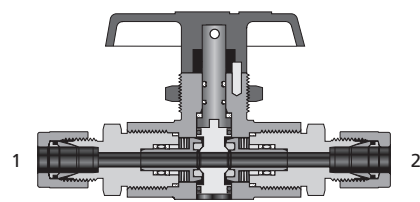

BF Series

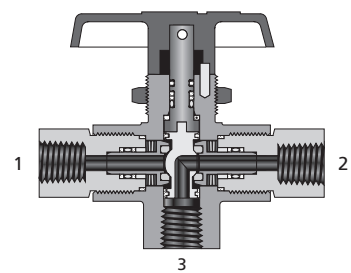

BF Series

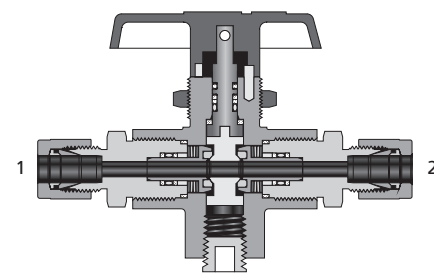

BFH Series

BG Series

- 3-piece precision cast body construction
- Body materials: CF8M (316), CF3M (316L), CF8 (304), CF3 (304L) and 904L SS
- Seat material: PTFE
- Packing material: PTFE
- End connections:
 - 1/8 to 1 thread
 - 1/8" to 1" pipe butt or socket weld
 - 1/4" to 2" and 6 mm to 25 mm tube butt or socket weld
 - 1/4" to 1" and 6 mm to 25 mm tube fitting
- Orifice sizes: 0.19" (4.8 mm) to 3" (76 mm)
- Working pressure up to: 1000 psig (69.0 bar)
- Working temperature: -20°F to 450°F (-28°C to 232°C)

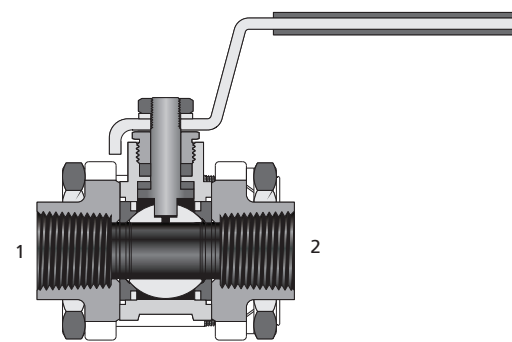

BH Series

- 3-piece precision cast body construction
- Body materials: CF8M (316), CF3M (316L), CF8 (304), CF3 (304L) and 904L SS
- Seat materials: PTFE, RPTFE and PEEK
- Packing materials: PTFE, RPTFE, Graphite and O-ring
- End connections:
 - 1/8 to 2 thread
 - 1/8" to 2" pipe butt or socket weld
 - 1/2" to 2" and 12 mm to 50 mm tube butt or socket weld
 - 1/2" to 2" and 12 mm to 38 mm tube fitting
- Orifice sizes: 0.19" (4.8 mm) to 1.5" (38.1 mm)
- Working pressure up to: 3000 psig (207 bar)
- Working temperature: -20°F to 450°F (-28°C to 232°C)

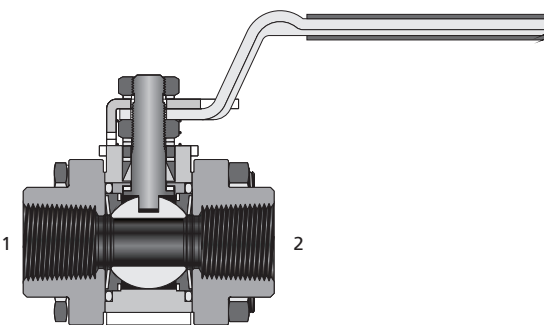

BO Series

- 1-piece forged body, top entry
- Body materials: 316 SS, 316L SS, 304 SS, 321 SS, 304L SS, 904L SS, alloy 400, and brass
- Seat materials: PTFE and UHMWPE
- Flow patterns: 2-way, 3-way, 4-way, 5-way, 6-way and 7-way
- End Connections:
 - 1/8 to 1/2 female thread
 - 1/16" to 3/4" and 3 mm to 18 mm tube fitting
- Orifice sizes: 0.05" (1.3 mm) to 0.41" (10.3 mm)
- Working pressure up to: 3000 psig (207 bar)
- Working temperature: -65°F to 300°F (-54°C to 148°C)

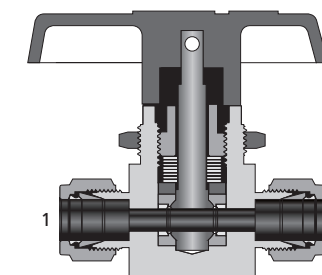

BR Series

- Cold drawn hex bar and casting body with single connector
- Body materials: 316 SS, 304 SS, 316L SS, 904L SS and brass
- Seat material: PTFE
- Packing material: PTFE
- End connections:
 - 1/8 to 1 thread
 - 1/4" to 1" and 6 mm to 25 mm tube fitting
- Orifice sizes: 0.19" (4.8 mm) to 0.63" (16 mm)
- Working pressure up to: 1000 psig (69.0 bar)
- Working temperature: -20°F to 450°F (-28°C to 232°C)

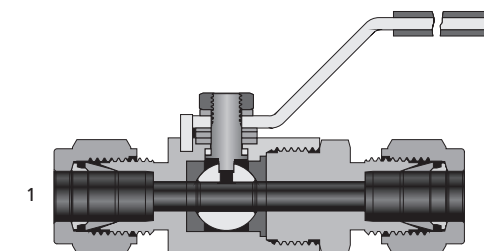

BP Series

- Cold drawn bar or forged body with end connectors
- Body materials: 316 SS, 304 SS, 321 SS, and 904L SS
- Seat materials: PVDF, PCTFE and PEEK
- Packing material: PTFE
- Flow patterns: 2-way and 3-way
- End connections:
 - 1/4 to 1 thread
 - 1/4" to 1" and 6 mm to 25 mm tube fitting
- Orifice sizes: 0.39" (10 mm), 0.5" (12.7 mm) and 0.71" (18 mm)
- Working pressure up to: 10 000 psig (690 bar)
- Working temperature: -40°F to 450°F (-40°C to 232°C)

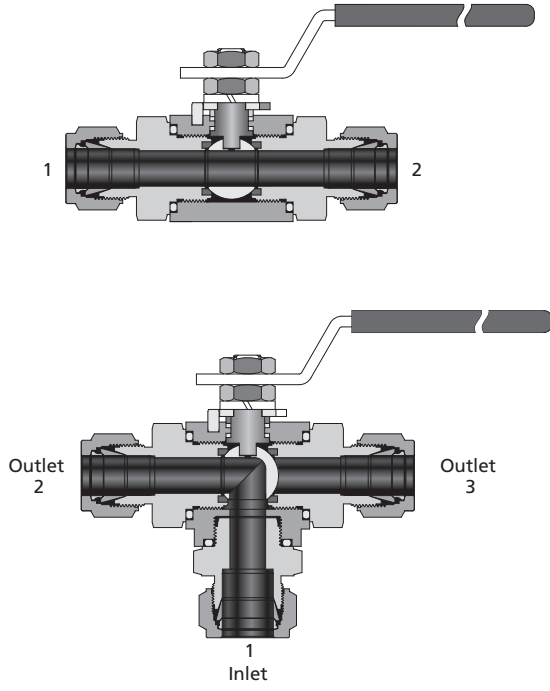

BV Series

- Precision cast body with end connectors
- Body materials: CF8M (316), CF3M (316L), CF8 (304), 904L SS, CF3 (304L) and brass
- Seat materials: PTFE, PCTFE and PEEK
- Packing material: PTFE
- Flow patterns: 2-way straight, 2-way angle, and 3-way
- End connections:
 - 1/8 to 3/4 thread
 - 1/8" to 3/4" and 3 mm to 22 mm tube fitting
- Orifice sizes: 0.09" (2.4 mm) to 0.41" (10.3 mm)
- Working pressure up to: 6000 psig (414 bar)
- Working temperature: -65°F to 450°F (-54°C to 232°C)

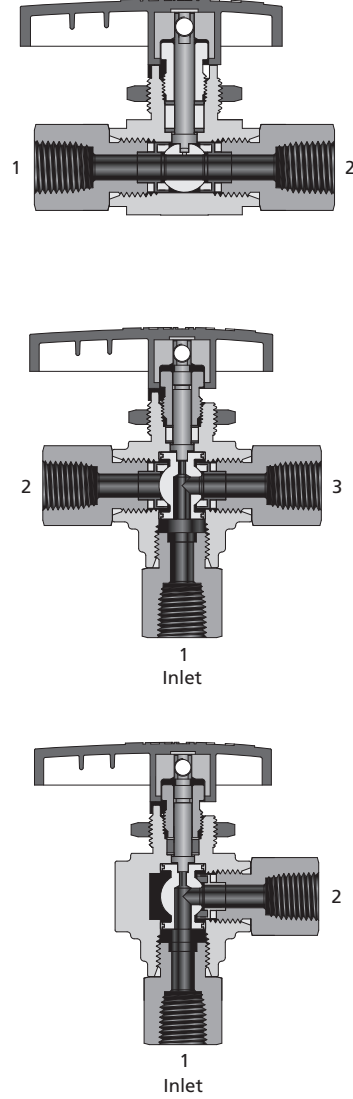

Part Number Description

BVSS – FL8 – FL8 – FNS8 – P10 – R – RXHQ3 – SF2

Series	Body Material	Port 1 Type	Port 1 Size	Port 2/3 Type	Port 2/3 Size	Seat Material	Orifice Size	Packing Material	Handler/ Actuator	For Actuator Pattern	Flow Pattern	Special Application	Cleaning and Packaging
BF	CF8M/ 316 SS	FNS	2 1/8"	Same as Port 1	02	Fluorocarbon FKM (BF, BFH)	0.09" (2.4 mm)	Black, Nylon (BF, BFH, BO, BV)	NO	Straight	NO	NO	NACE MR0175
BFH	CF3M/ 316L SS	NS	3 3 mm	Specify every Port designator if any of its Ports is different from the others	03	PTFE (BG, BH, BO, BP, BR, BV)	0.13" (3.2 mm)	Stainless steel with yellow vinyl covered (BG, BH, BP, BR)	H	Angle (Bottom Port Inlet)	Mechanical Limit Switch	FC-01	FC-02
BG	CF8/ 304 SS	FRT	4 1/4"		04	Buna N	0.17" (4.2 mm)	Red Handle or Vinyl Covered (BG, BH, BP, BR)	N	3-way	Inductive Limit Switch	F2	FC-02
BH	CF3/ 304L SS	RT	5 5/16"		05	Ethylene propylene	0.19" (4.7 mm)	Green Handle or Vinyl Covered	Q	4-way	Electromagnetic Valve		
S1	321 SS	FMS	6 3/8" or 6 mm or M6 x 1		07	Graphite	0.28" (7.1 mm)	Blue Handle or Vinyl Covered	HQ	5-way For BO Series	Mechanical Limit Switch and Electromagnetic Valve		
B	Brass	MS	8 1/2" or 8 mm		10	UHMWPE	0.35" (8.9 mm) For BR	Yellow Nylon	NQ	6-way	Inductive Limit Switch and Electromagnetic Valve		
M	Alloy 400	FRP	10 10 mm or M10 x 1		11	Fluorocarbon FKM	0.40" (10.3 mm) For BV BH Series	Black Aluminium		7-way			
22	F22	BP	12 3/4" or 12 mm		13	Neoprene	0.42" (10.6 mm)	90° Normally Closed Spring Return Pneumatic Actuator	CS				
91	F91	FL	14 14 mm or M14 x 1.5		22	PEEK	0.50" (12.7 mm)	90° Normally Open Spring Return Pneumatic Actuator	OS				
D5	Duplex 2205	ML	16 1" or 16 mm		22	RPTFE	0.88" (22.2 mm)	90° Double Acting Pneumatic Actuator	DA				
D7	Duplex 2507	MTS	18 18 mm			PTFE		180° left end normally open spring return pneumatic actuator	LX				
INC	Inconel 600	TS	20 20 mm or M20 x 1.5			H		180° right end normally open spring return pneumatic actuator	RX				
CS	Carbon Steel	MTB	22 22 mm or M22 x 1.5			K		180° Double Acting Pneumatic Actuator	DX				
904L	904L SS	TB	24 2 1/2" or M24 x 1.5			P		90° Electric Actuator	EA				
		P5	25 25 mm			R		180° Electric Actuator	EX				
		PB	27 M27 x 2										
		UFB	28 28 mm										
		UMB	32 2" or 32 mm										
		UPB	36 2 1/4" or M36 x 2										
			40 2 1/2" or M40 x 2										
			48 3" or M48 x 2										
			64 4"										

Note: "Part Number Description" is used for composition rules of FITOK product model, Not suitable for specific product part number selection, not random combinations. If in doubt, please contact FITOK group or authorized agent.

Bleed Valves

RB Series

- Compact design for convenient installation
- Chrome-plated stem and tip extend cycle life
- Working pressure up to 10 000 psig (690 bar)
- Working temperature: -65°F to 850°F (-54°C to 454°C)
- Stainless steel, carbon steel, and alloy R-405 body materials
- End connections:
 - 1/8 to 1/2 male NPT
 - 1/4 to 1/2 male BSPT
 - M6 x 1, M8 x 1 and M10 x 1 male Metric Thread

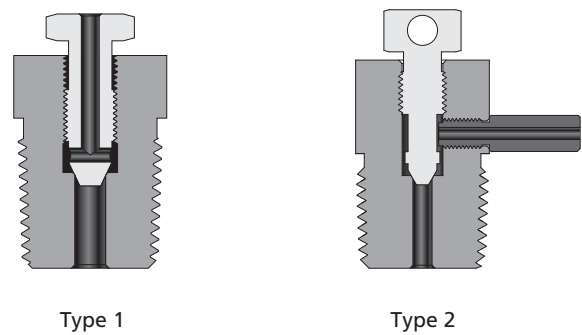

Part Number Description

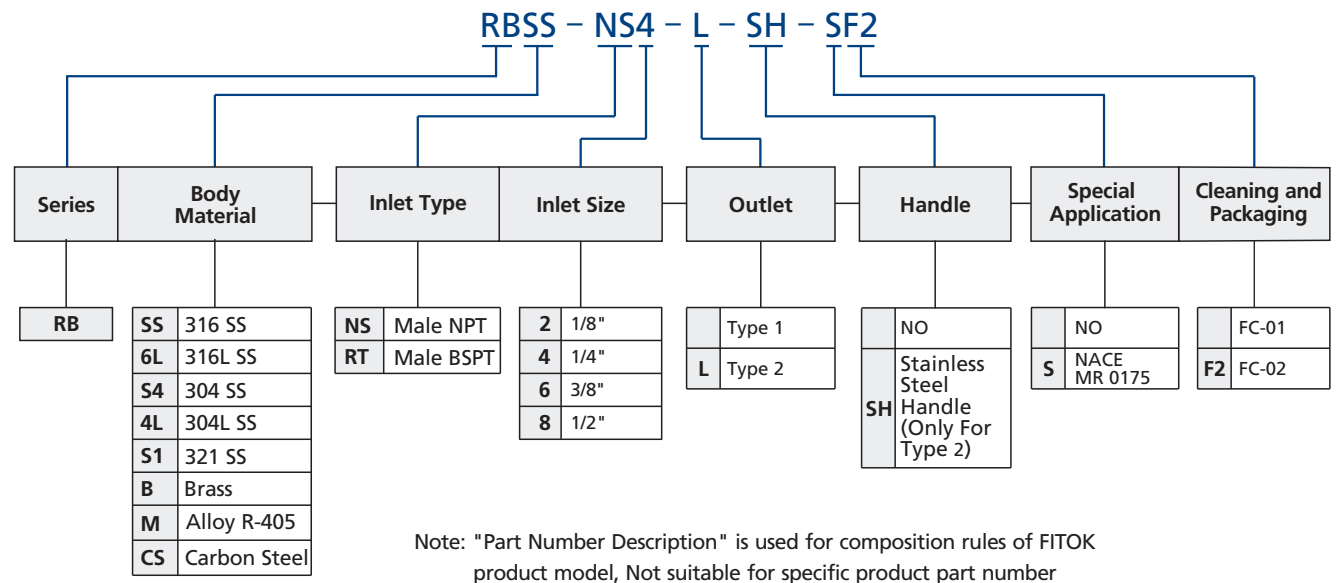

Note: "Part Number Description" is used for composition rules of FITOK product model, Not suitable for specific product part number selection, not random combinations. If in doubt, please contact FITOK group or authorized agent.

Check Valves



CV, CH and CO Series

Fixed cracking pressure
Can be installed in any direction

CV Series

- The resilient O-ring seat design provides cushioned and noise-free closing, and resists seat flow-out.
- Working pressure up to: 3000 psig (207 bar)
- Working temperature: -10°F to 375°F (-23°C to 190°C)
- Cracking pressure: 1/3 to 25 psig (0.02 to 1.7 bar)
- Body materials: stainless steel, brass, and alloy
- End connections:
 - 1/8" to 1" and 6 mm to 12 mm tube fitting
 - 1/8 to 1 female NPT
 - 1/8 to 1 male NPT
 - 1/4 to 1 male FR fitting

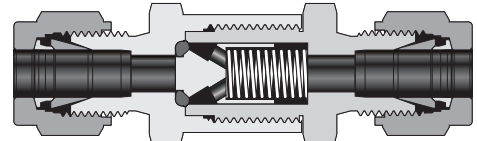

CH Series

- The seat ring is continuously cleaned by media, avoiding secondary pollution.
- Working pressure up to: 6000 psig (414 bar)
- Working temperature: -10°F to 400°F (-23°C to 204°C)
- Cracking pressure: 1/3 to 25 psig (0.02 to 1.7 bar)
- Body materials: stainless steel and alloy
- End connections:
 - 1/8" to 1" and 6 mm to 25 mm tube fitting
 - 1/8 to 1 female NPT, 1/8 to 1 male NPT
 - 1/4 to 1 female BSPT, 1/4 to 1 male BSPT
 - 1/4 to 3/4 male FO fitting, 1/4 to 1 male FR fitting

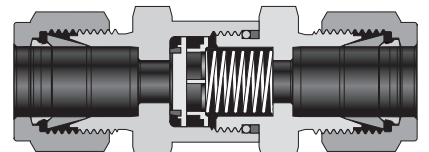

CO Series

- Compact, one piece body
- Working pressure up to: 3000 psig (207 bar)
- Working temperature: -10°F to 375°F (-23°C to 190°C)
- Cracking pressure: 1/3 to 25 psig (0.02 to 1.7 bar)
- Body materials: stainless steel, brass, and alloy
- End connections:
 - 1/4 to 1/2 NPT
 - 1/4 to 1/2 BSPT

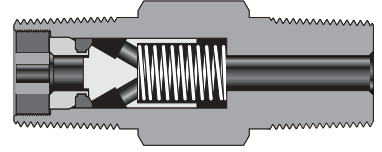

CA and COA Series

Adjustable cracking pressure
Variety of springs available
Installation in any direction

CA Series

- Working pressure up to: 3000 psig (207 bar)
- Working temperature: -10°F to 375°F (-23°C to 190°C)
- Cracking pressure: 3 to 600 psig (0.2 to 41.4 bar)
- Body materials: stainless steel, brass, and alloy
- End connections:
 - 1/4" to 3/8" and 8 mm tube fitting
 - 1/4 male FR fitting

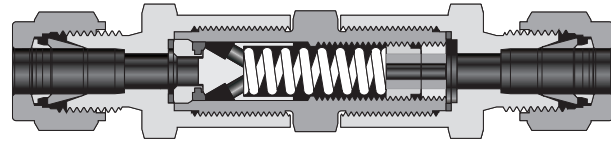

COA Series

- Compact, one piece body
- Working pressure up to: 3000 psig (207 bar)
- Working temperature: -10°F to 375°F (-23°C to 190°C)
- Cracking pressure: 3 to 600 psig (0.2 to 41.4 bar)
- Body materials: stainless steel, brass, and alloy
- End connections:
 - 1/4 female NPT
 - 1/4 to 1/2 male NPT
 - 1/4 to 1/2 male BSPT

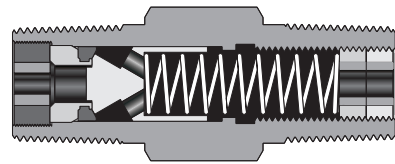

CL Series

Union bonnet design
All stainless steel construction
Horizontal installation

- Working pressure up to: 6000 psig (414 bar)
- Working temperature: -65°F to 900°F (-53°C to 482°C)
- Body materials: stainless steel
- End connections:
 - 1/4" to 3/4" and 6 mm tube fitting
 - 1/8 to 1/2 female NPT
 - 1/4" to 1/2" tube socket weld
 - 1/4" to 1/2" pipe butt weld

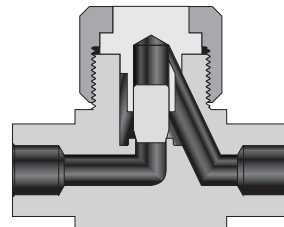

CW Series

All-welded design for enhanced safety
Installation in any directions

- Working pressure up to: 3000 psig (207 bar)
- Working temperature: -10°F to 400°F (-23°C to 204°C)
- Cracking pressure: less than 2 psig (0.14 bar)
- Body materials: stainless steel
- End connections:
 - 1/4" and 6 mm tube fitting
 - 1/4" to 1/2" male and female FR fitting
 - 1/4" to 1/2" and 6 mm tube butt weld

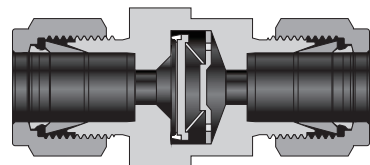

Part Number Description

CVSS - FL8 - ML10 - B - 2SF2

Series	Body Material	Inlet Type	Inlet Size	Outlet Type	Outlet Size	Seal Material	Cracking Pressure	Special Application	Cleaning and Packaging	
CV	SS 316 SS	FNS Female NPT	2 1/8"			Fluorocarbon FKM	3 psig	For CV CH CO Series	NO S NACE MR0175 F2 FC-02	
CH	6L 316L SS	NS Male NPT	4 1/4"			B Buna N	1 1/3 psig			
CO	M Alloy 400	FRT Female BSPT	6 3/8" or 6 mm			N Neoprene	2 1 psig			
CA	B Brass	RT Male BSPT	8 1/2" or 8 mm			E Ethylene propylene	3 10 psig			
COA		FMS Female Metric Thread (for RP-M)	10 10 mm			Z Kalrez	4 25 psig	For CA COA Series		
CL		MS Male Metric Thread (for RG-M)	12 3/4" or 12 mm			Same as Inlet	5 3 to 50 psig			
CW		FRP Female BSPP (for RP)	14 14 mm or M14 x 1.5			Specified in the same way as the inlet type and size	6 50 to 150 psig			
		BP Male BSPP (for RG)	16 1" or 16 mm				7 150 to 350 psig			
		TS Fractional Tube Socket Weld	18 18 mm							7 350 to 600 psig
		MTS Metric Tube Socket Weld	20 1 1/4" or 20 mm or M20 x 1.5							
		TB Fractional Tube Butt Weld	22 22 mm or M22 x 1.5							
		MTB Metric Tube Butt Weld	25 25 mm							
		PS Pipe Socket Weld								
		PB Pipe Butt Weld								
		FL Fractional Tube Fitting								
		ML Metric Tube Fitting								
		UFB Nut+Gasket+ Fractional Bulge Nipple								
		UMB Nut + Gasket + Metric Bulge Nipple								
		FO Male FO Fitting								
		FFR Female FR Fitting								
		FR Male FR Fitting								
		RFR Rotatable Male FR Fitting								

1. Note: "Part Number Description" is used for composition rules of FITOK product model, Not suitable for specific product part number selection, not random combinations. If in doubt, please contact FITOK group or authorized agent.

2. The material in "Part Number Description" is general material, end connection type & size is general standard. If other end connection is needed, please contact FITOK group or authorized agent.

Part Number Description of Spring Kits

SSCV - SP8 - 2

Spring Material	Series	Part Name	Body Size	Cracking Pressure
SS 316 SS	CV	SP Spring	4	3 psig
S4 304 SS	CH		8	1 1/3 psig
S2 302 SS	CO		12	2 1 psig
A75 X-750	CA		16	3 10 psig
	COA			4 25 psig
				5 3-50 psig
				6 50-150 psig
				7 150-350 psig
				7 350-600 psig

2. Note: "Part Number Description" is used for composition rules of FITOK product model, Not suitable for specific product part number selection, not random combinations. If in doubt, please contact FITOK group or authorized agent.

2. The material in "Part Number Description" is general material. If other material is needed, please contact FITOK group or authorized agent.

Excess Flow Valves

EV Series

- Compact design for convenient installation
- Working pressure up to: 6000 psig (414 bar)
- Working temperature: -10°F to 400°F (-23°C to 204°C)
- Stainless steel construction
- Leak-tight performance testing for every valve with nitrogen at the maximum working pressure
- End connections:
 - 1/4" to 1/2" male 6 mm to 12 mm tube fitting
 - 1/4 to 1/2 male FR Fitting
 - 1/4 to 1/2 NPT



Part Number Description

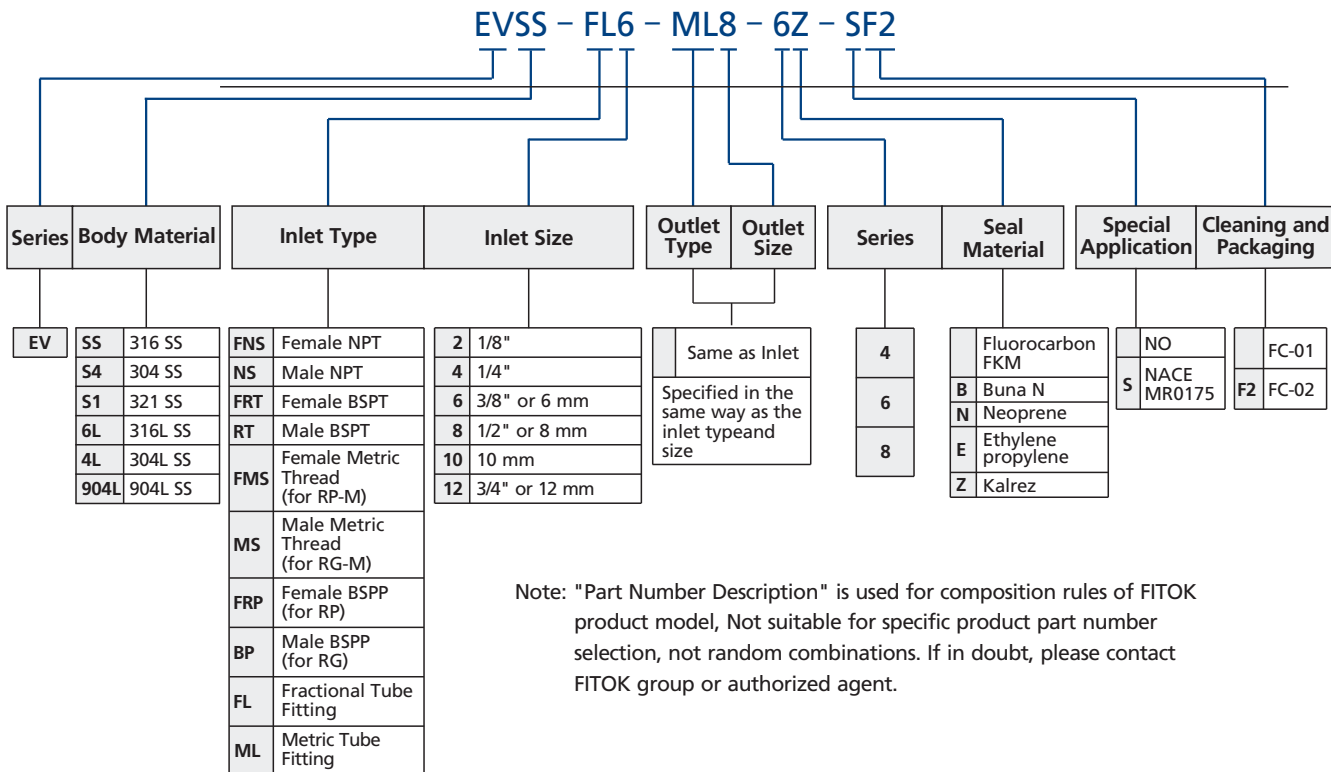

Note: "Part Number Description" is used for composition rules of FITOK product model, Not suitable for specific product part number selection, not random combinations. If in doubt, please contact FITOK group or authorized agent.

Purge Valves

RP Series

- Compact design for convenient installation
- Bonnet crimped to valve body to prevent accidental disassembly
- Straight, tee and cross body constructions
- Working pressure up to: 4000 psig (276 bar)
- Working temperature: -65°F to 600°F (-54°C to 315°C)
- Stainless steel, brass, and carbon steel body materials
- End connections:
 - 1/8" to 1" and 3 mm to 16 mm tube fitting
 - 1/8 to 1 female NPT
 - 1/8 to 1 male NPT

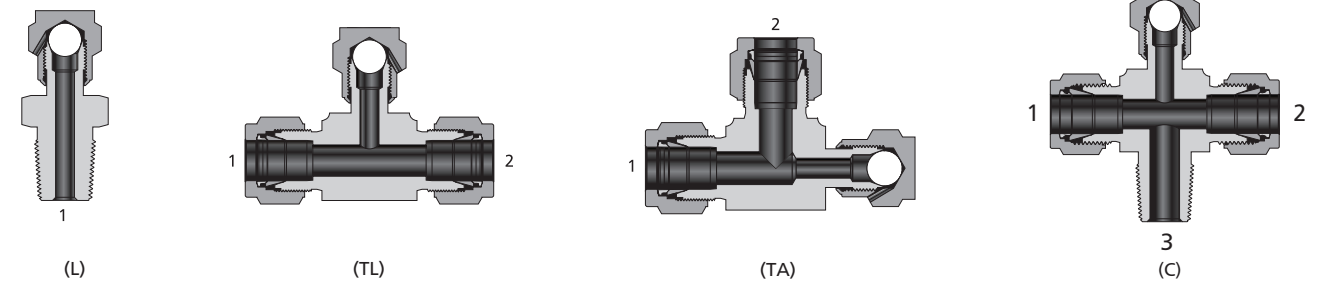

Part Number Description

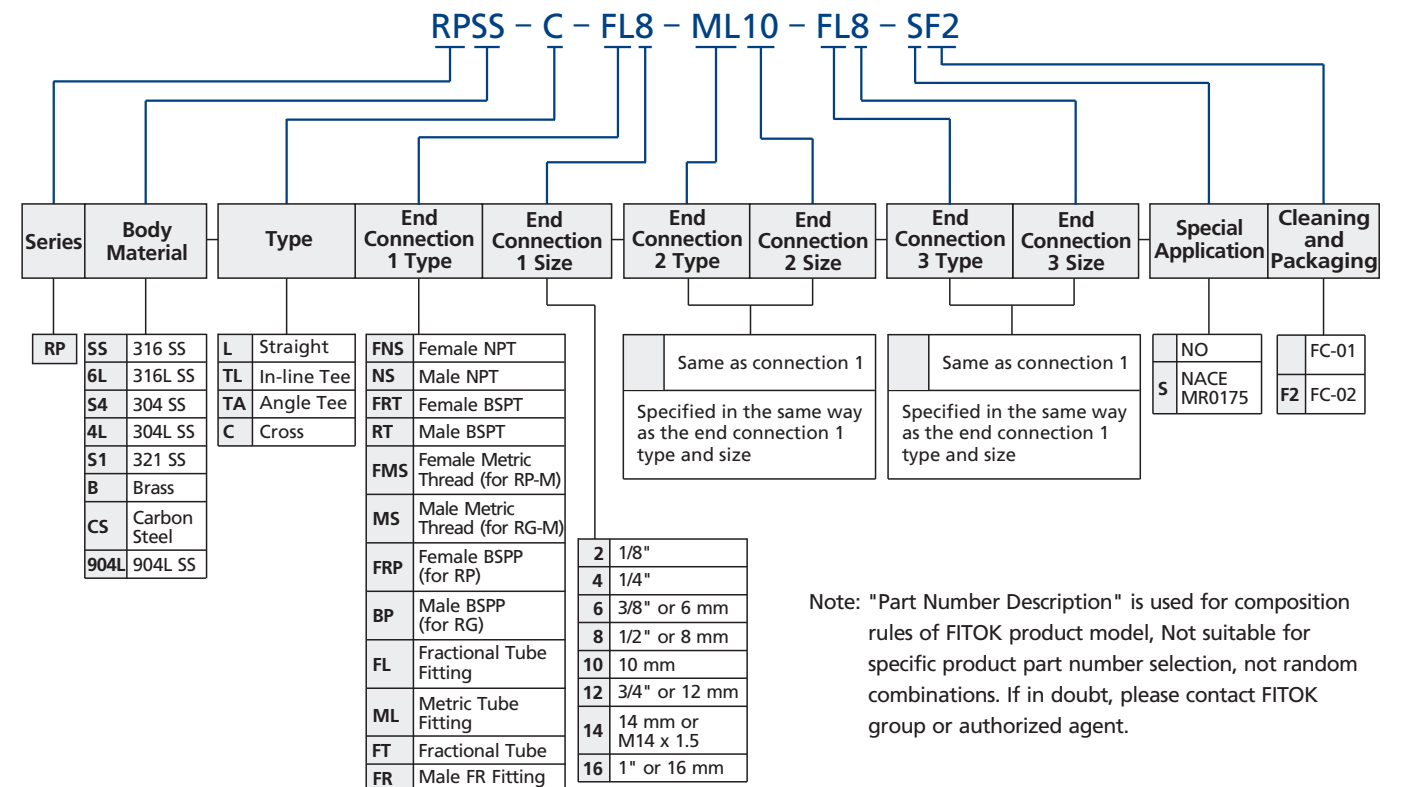

Note: "Part Number Description" is used for composition rules of FITOK product model, Not suitable for specific product part number selection, not random combinations. If in doubt, please contact FITOK group or authorized agent.

Relief Valves



RV Series

- Set Pressure: 7 color-coded springs available for a wide range of set pressure, 50 to 6000 psig @ 70°F (3.4 to 414 bar @ 20°C)
- Maximum outlet pressure: 1500 psig (103 bar)
- Orifice size: RV Series: 0.14" (3.6 mm)
- Balance stem design to eliminate the effect of system back pressure
- Working temperature: -10°F to 300°F (-23°C to 148°C)
- Liquid or gas service
- Adjustable bonnet cap and adjustable set pressure
- Lock wired secure cap to maintain the set pressure
- Variety of seal materials
- Label identifies the set pressure range.
- Manual override handle available to open the valve without changing the set pressure which is lower than 1500 psig
- End connections: 1/4" and 6 mm to 8 mm tube fitting, 1/4 NPT

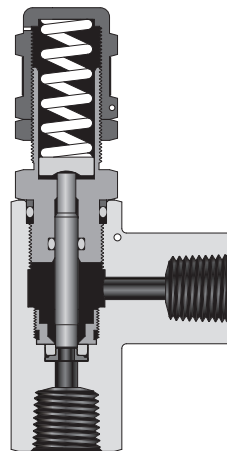

RL Series

- Set Pressure: 10 to 225 psig @ 70°F (0.68 to 15.5 bar @ 20°C)
- Maximum outlet pressure: 225 psig (15.5 bar)
- Orifice size: 0.19" (4.8 mm) and 0.25" (6.4 mm)
- Pre-set pressure = Desired pressure - 0.8 × Back pressure
- Working temperature: -10°F to 300°F (-23°C to 148°C)
- Liquid or gas service
- Adjustable bonnet cap and adjustable set pressure
- Lock wired secure cap to maintain the set pressure
- Variety of seal materials
- Label identifies the set pressure range
- Manual override handle available to open the valve without changing the set pressure which is lower than 1500 psig
- End connections: 1/4" to 1/2" and 6 mm to 12 mm tube fitting, 1/4 to 1/2 NPT

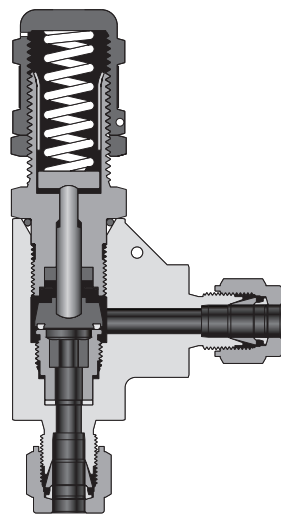

RM Series

- Set Pressure: 3 color-coded springs available for a wide range of set pressure, 50 to 1500 psig @ 70°F (3.4 to 103 bar @ 20°C)
- Maximum outlet pressure: 1500 psig (103 bar)
- Orifice size: 0.25" (6.4 mm)
- Balance stem design to eliminate the effect of system back pressure
- Working temperature: -10°F to 300°F (-23°C to 148°C)
- Liquid or gas service
- Adjustable bonnet cap and adjustable set pressure
- Lock wired secure cap to maintain the set pressure
- Variety of seal materials
- Label identifies the set pressure range
- Manual override handle available to open the valve without changing the set pressure which is lower than 1500 psig
- End connections: 3/8" to 1/2" and 8 mm to 12 mm tube fitting, 1/4 to 1/2 NPT

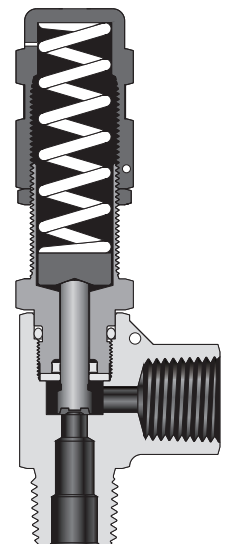

Part Number Description Spring for Valves

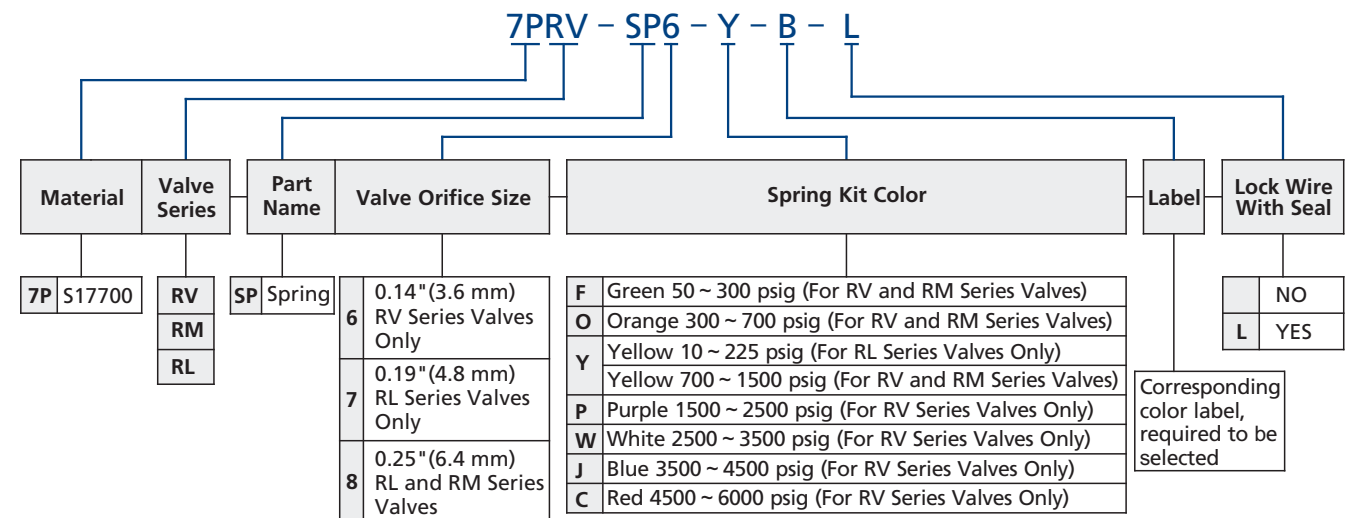

Note: Most configurations are available but not everyone.

- Every spring kit includes a corresponding color label.

Part Number Description
Valves

RVSS – FL6 – ML8 – 6Z – WM – LSF2												
Series	Body Material	Inlet Type	Inlet Size	Outlet Type	Outlet Size	Orifice Size	Seal Material	Spring Kit Color	Manual Override Handle	Lock wire with seal	Special Application	Cleaning and Packaging
RV	SS 316 SS	FNS Female NPT	2 1/8"	Same as inlet	6	0.14" (3.6 mm) RV Only	Fluorocarbon FKM	Yellow 10 ~ 225 psig (RL Only)	None	No	No	FC-01
RM	S4 304 SS	NS Male NPT	4 1/4"				6 B Buna N	Green 50 ~ 300 psig (RV and RM)				
RL	S1 321 SS	FRT Female BSPT	6 3/8" or 6 mm	Specified in the same way as the inlet type and size	7	0.19" (4.8 mm) RL Only	N Neoprene	Orange 300 ~ 700 psig (RV and RM)	M Manual Override Handle	S NACE MR0175		
6L	316L SS	RT Male BSPT	8 1/2" or 8 mm				E Ethylene propylene	Yellow 700 ~ 1500 psig (RV and RM)				
4L	304L SS	FMS Female Metric Thread (for RG)	10 10 mm		8	0.25" (6.4 mm) RL and RM	Z Kalrez RV Only	Purple 1500 ~ 2500 psig (RV Only)				
904L	904L SS	MS Male Metric Thread (for RG)	12 3/4" or 12 mm				W White 2500 ~ 3500 psig (RV Only)					
		FRP Female BSPP (for RP)										
		BP Male BSPP (for RG)										
		FL Fractional Tube Fitting										
		ML Metric Tube Fitting										

Note: Most configurations are available but not everyone.

Bellows-sealed Valves



- Secondary containment system above the bellows.
- Hydraulic-formed multilayer bellows enhance cycle life.
- Nonrotating stem tip eliminates galling within the seat area.
- Strictly controlled bellows stroke to improve safety and cycle life.
- Replaceable bellows and stem assembly.
- Regulating, conical and spherical stem tips available.
- Panel, bottom and side mounting available.

SW Series

- Working pressure up to: 1000 psig (69.0 bar)
- Working temperature: -20°F to 900°F (-28°C to 482°C)
- Stainless steel, brass and alloy 400 body materials
- End connections:
 - 1/4" to 1" and 6 mm to 25 mm tube fitting
 - 1/4" to 1/2" and 6 mm to 12 mm tube socket weld
 - 1/4" to 1/2" and 6 mm to 12 mm tube butt weld
 - 1/4 to 1/2 FR fitting

SU Series

- Working pressure up to: 2500 psig (172 bar)
- Working temperature: -20°F to 1200°F (-28°C to 649°C)
- Stainless steel body materials
- End connections:
 - 1/4" to 1/2" and 6 mm to 25 mm tube fitting
 - 1/4" to 1" and 6 mm to 25 mm tube socket weld
 - 3/8" to 1" and 6 mm to 25 mm tube butt weld
 - 1/4 to 1/2 FR fitting

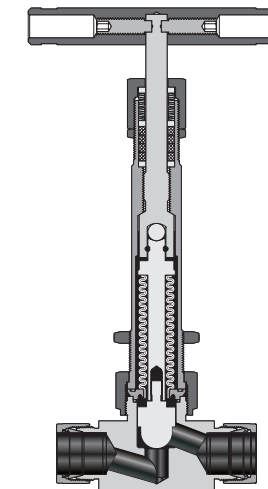
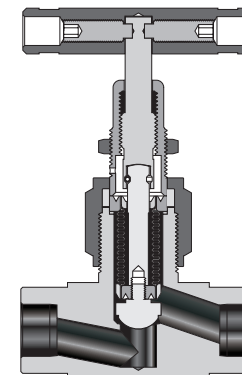

Part Number Description

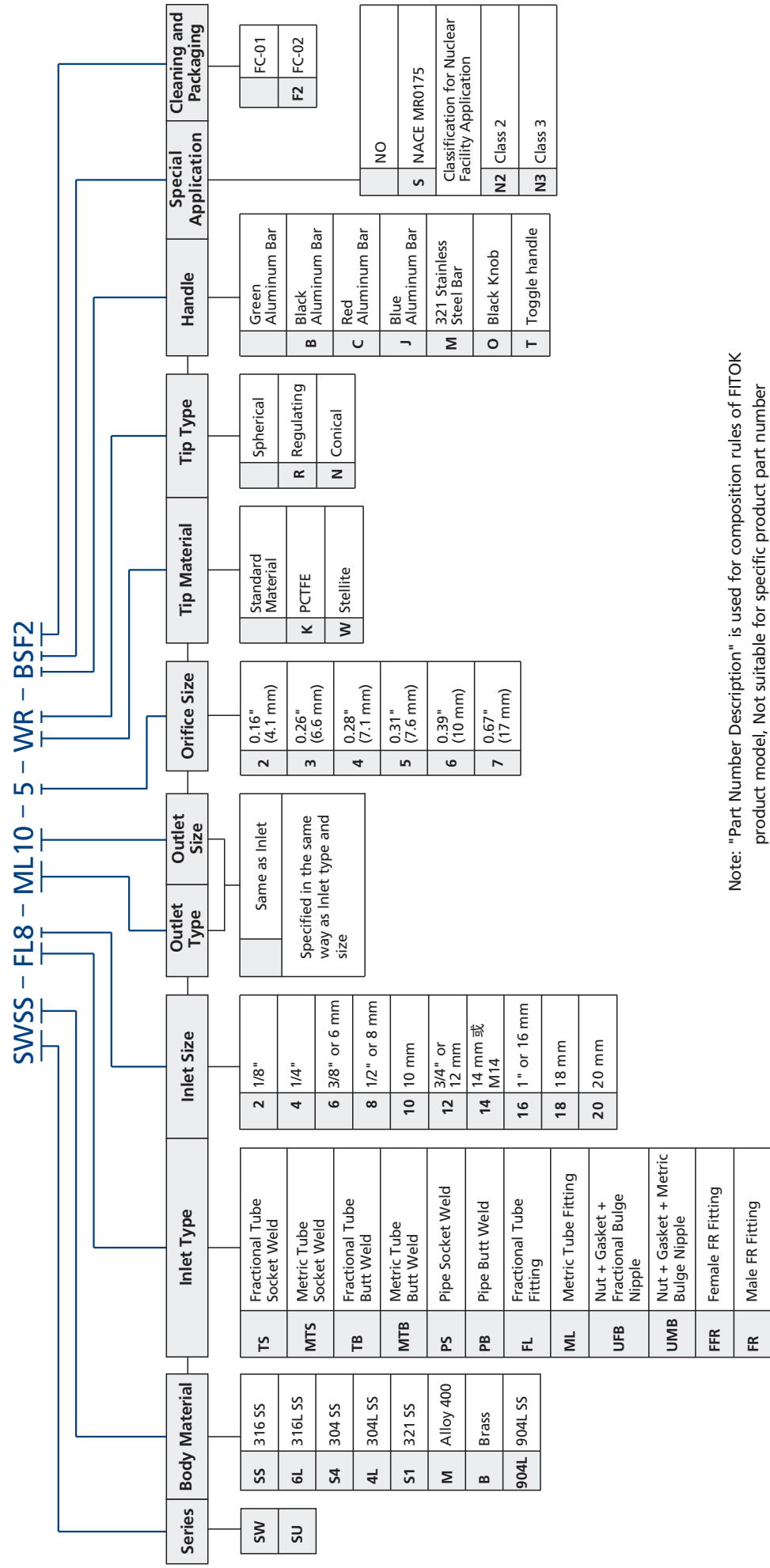

Note: "Part Number Description" is used for composition rules of FITOK product model, Not suitable for specific product part number selection, not random combinations. If in doubt, please contact FITOK group or authorized agent.

Metering Valves



MS Series

- Working pressure up to: 2000 psig (138 bar)
- Working temperature: -10°F to 400°F (-23°C to 204°C)
- Orifice size: 0.032" (0.81 mm)
- Flow coefficient (Cv): 0.004
- Stem taper: 1°
- Turns to open: 9 to 12
- Shutoff service: not available
- Panel mountable
- Flow patterns: straight, angle, cross and double
- Handle types: round, vernier, slotted and adjustable-torque
- Variety of materials available for valve body
- End connections: 1/16" to 1/4" and 3 mm to 6 mm tube fitting, 1/4 male FR Fitting, 1/8 to 1/4 NPT

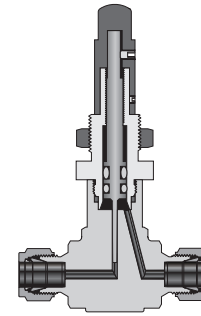

MV and ML Series

- Working pressure up to: 1000 psig (69.0 bar)
- Working temperature: -10°F to 400°F (-23°C to 204°C)
- Flow coefficients (Cv): MV series: 0.03, ML series: 0.15
- Orifice sizes: MV series: 0.056" (1.42 mm), ML series: 0.128" (3.25 mm)
- Stem taper: MV series: 3°, ML series: 6.5°
- Turns to open: MV series: 8 to 10
- ML series: 10 to 11
- Shutoff service: MV series: not available
- ML series: available
- Panel mountable
- Flow patterns: straight, angle, cross (MV Series) and double (MV Series)
- Handle types: round, vernier, slotted and adjustable-torque
- Variety of materials available for valve body
- End connections: 1/8" to 1/4" and 3 mm to 8 mm tube fitting, 1/4 male FR Fitting, 1/8 to 1/4 NPT

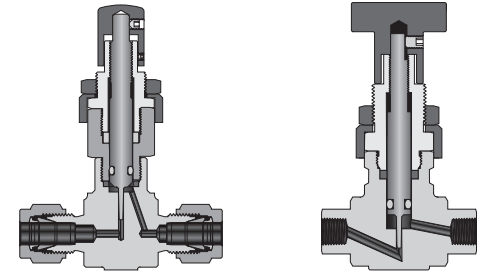

MH Series

- Working pressure up to: 5000 psig (345 bar)
- Working temperature: -65°F to 850°F (-54°C to 454°C)
- Orifice size: 0.062" (1.6 mm)
- Flow coefficient (Cv): 0.04
- Stem taper: 2°
- Shutoff service: available
- Variety of end connections
- Turns to open: 9 to 10
- Panel mountable
- Flow patterns: straight and angle
- Handle type: round phenolic, vernier
- Variety of materials available for valve body
- End connections: 1/8" to 1/4" and 3 mm to 8 mm tube fitting, 1/4 male FR Fitting, 1/8 to 1/4 NPT

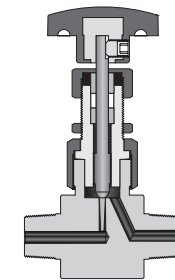

Part Number Description

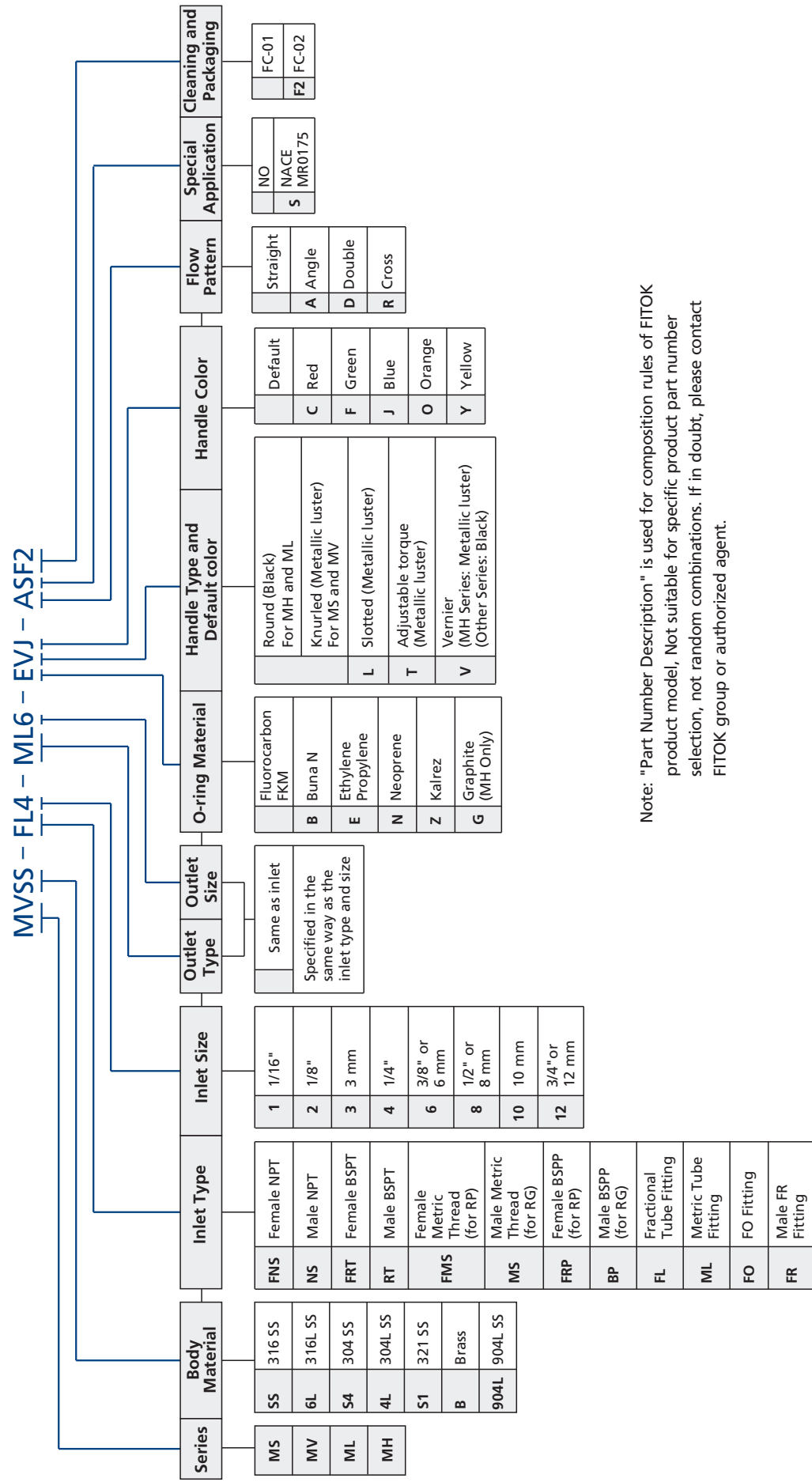

Needle Valves



Needle Valves Features

- The nonrotating stem eliminates galling between the seat and tip, and reducing the friction of sealed packing. Effectively improve the service life of the valve and valve packing.
- Intermittent packing system designed to effectively reduce the cold flow of valve packing and the valve operating torque, while use System media for the useful of valve packing.
- Packing mounted on the bottom of the stem transmission thread designed to achieve the isolation of transmission thread lubricating material and system medium to prevent transmission thread lubricating substance contamination of the media on the system.
- Threaded operating torque transmitted using online extrusion and roll forming process, Effectively improve the strength and precision of the threads. To provide strong protection for operating torque for the screw to pass long-term, stable and reliable torque transmission.
- Different body materials and structure selection, a variety of colors and forms of the handle, and optional panel mounting structure to achieve different requirements, different application occasions.
- Valve reference standard: According to ASME B16.34, each valve is tested for strength and leak-tight performance with pure water or nitrogen at max working pressure before delivered out.

Forged Needle Valves

NF, NFH Series

- One-piece forged body.
- Body materials: Carbon steel/A105, 316 SS, 316L SS, 304 SS, 304L SS, 321 SS, Duplex 2205, Alloy 400, Alloy C- 276, and brass, other material please contact with manufacture.
- Orifice (mm): 4, 6.4, 10, 15 and 18. (15 and 18 suitable for NF series only).
- Working pressure up to: NF Series—6000 psig (41.4 MPa); NFH Series—10000 psig (69.0 MPa).
- Working temperature: -65°F to 1200°F (-54°C to 649°C).
- Sealing face materials: Same as body material, optional stellite available.
- Stem tips type: blunt, ball, regulating, and soft tips (suitable for NF series only).
- End connections type and size:
 - 1/8" to 1", M10 to M36 thread;
 - 1/4" to 1", 6 mm to 28 mm tube fitting;
 - 3/8" to 1", 10 mm to 25 mm weld.

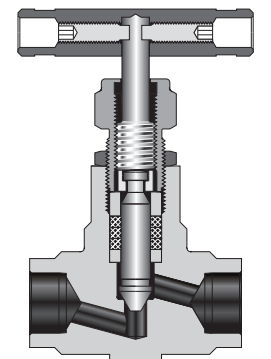

Bar Stock Needle Valves

NB, NBH Series

- Cold drawn bar.
- Body materials: 316 SS, 316L SS, 304 SS, 304L SS, Duplex 2205, Alloy 400, Alloy C- 276, and brass, other material please contact with manufacture.
- Orifice (mm): 4, 6.4, 10, 15 and 18. (15 and 18 suitable for NB series only).
- Working pressure up to: NB Series—6000 psig (41.4 MPa); NBH Series—10000 psig (69.0 MPa).
- Working temperature: -65°F to 1200°F (-54°C to 649°C).
- Sealing face materials: Same as body material, optional stellite available.
- Stem tips type: blunt, ball, regulating, and soft tips (suitable for NB series only).
- End connections type and size: 1/8" to 1", M14 to M27 thread; 1/4" to 1", 6 mm to 25 mm tube fitting; 3/8" to 1", 10 mm to 28 mm weld.

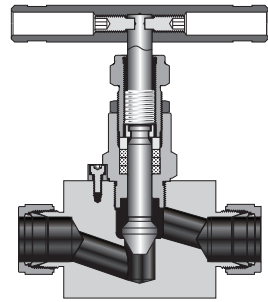

General Purpose Needle Valves

NG, NGH Series

- One-piece forged body.
- Body materials: Carbon steel/A105, 316 SS, 316L SS, 304 SS, 304L SS, Duplex 2205, Alloy 400, Alloy C- 276, and brass, other material please contact with manufacture.
- Orifice (mm): 2, 4, 6.4, 10
- Working pressure up to: NG Series—3000 psig (20.7 Mpa); NGH Series—5000 psig (34.5 Mpa).
- Working temperature: -65°F to 500°F (-54°C to 260°C);
- Sealing face materials: Same as body material.
- Stem tips type: blunt, ball, regulating, and soft tips.
- End connections type and size: 1/8" to 3/4", M14 to M27 thread; 1/4" to 3/4", 6 mm to 25 mm tube fitting.

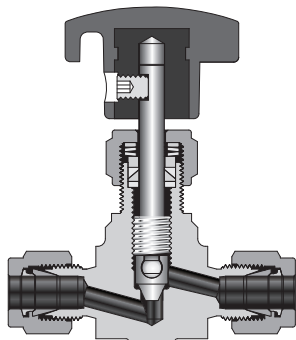

Union Bonnet Needle Valves

NU, NUH Series

- One-piece forged body.
- Body materials: 316 SS, 316L SS, 304 SS, 304L SS, Duplex 2205, Alloy 400, Alloy C- 276, and brass, other material please contact with manufacture.
- Orifice (mm): 4, 6.4, 10
- Working pressure up to: NU Series—6000 psig (41.4 MPa); NUH Series—10000 psig (69.0 MPa).
- Working temperature: -65°F to 1200°F (-54°C to 649°C).
- Sealing face materials: Same as body material, optional stellite available.
- Stem tips type: blunt, ball, regulating, and soft tips (suitable for NU series only).
- End connections type and size: 1/8" to 1", M14 to M27 thread; 1/4" to 1", 6 mm to 25 mm tube fitting; 3/8" to 1", 10 mm to 28 mm weld.

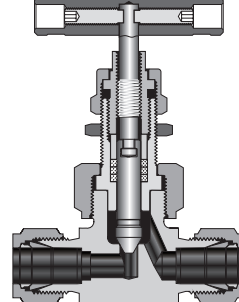

Nonrotating-stem Needle Valves

ND, NDH Series

- One-piece forged body.
- Body materials: 316 SS, 316L SS, 304 SS, 304L SS, Alloy 400 and brass, other material please contact with manufacture.
- Orifice (mm): 2, 4, 5.6
- Working pressure up to: ND Series—3000 psig (20.7 MPa); NDH Series—5000 psig (34.5 MPa).
- Working temperature: -20°F to 450°F (-28°C to 232°C).
- Designed handle to prevent contaminants from entering into the valve.
- Non-rotating stem, soft stem tip.
- End connections type and size: 1/8" to 1/2", M10 to M14 thread; 1/4" to 1/2", 3 mm to 12 mm tube fitting.

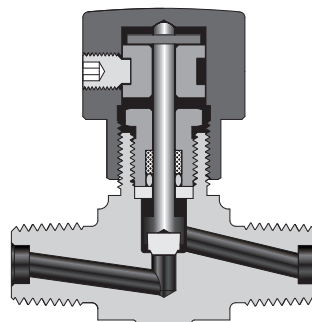

Toggle Valves

NT Series

- One-piece forged body.
- Body materials: 316 SS, 316L SS, 304 SS, 304L SS, and brass, other material please contact with manufacture.
- Orifice (mm): 2, 4, 6.4
- Working pressure up to: 300 psig (2.07 Mpa).
- Working temperature: -20°F to 250°F (-28°C to 121°C).
- Sealing face materials: Same as body material.
- End connections type and size: 1/8" to 1/2", M10 to M20 thread; 1/4" to 1/2", 3 mm to 12 mm tube fitting.

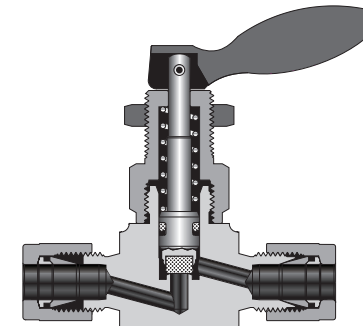

Rising Plug Valves

NR, NRG Series

- Cold drawn square bar.
- Body materials: 316 SS, 316L SS, 304 SS, 304L SS, Duplex, Alloy 400, Alloy C-276, and brass, other material please contact with manufacture.
- Orifice (mm): 4, 6.4
- Working pressure up to: 6000 psig (41.4 Mpa).
- Working temperature: -20°F to 400°F (-28°C to 204°C).
- Sealing face materials: soft seat design, seat material: Acetal, PEEK, PFA.
- End connections type and size: 1/8" to 1/2", M14 to M20 thread; 1/4" to 1/2", 6 mm to 12 mm tube fitting.

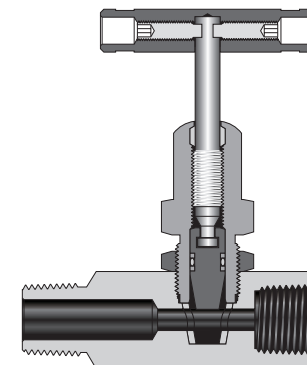

Outside Screw and Yoke (OS&Y) Needle Valves

NY, NYH Series

- Cold drawn bar.
- Body materials: Carbon steel/A105, 316 SS, 316L SS, 304 SS, 304L SS, Duplex, Alloy 400, Alloy C-276, and brass, other material please contact with manufacture.
- Orifice (mm): 4
- Working pressure up to: NY Series—6000 psig (41.4 Mpa); NYH Series—10000 psig (69.0 MPa).
- Working temperature: -65°F to 1200°F (-54°C to 649°C).
- Sealing face materials: Same as body material, optional stellite available.
- Externally adjustable gland independent of spindle thread.
- End connections type and size: 1/4" to 1/2", M10 to M20 thread; 1/4" to 1/2", 6 mm to 12 mm tube fitting; 3/8" to 1/2", 10 mm to 20 mm weld.

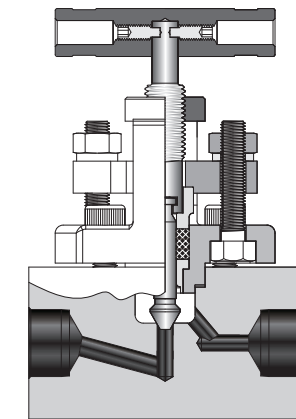

Part Number Description

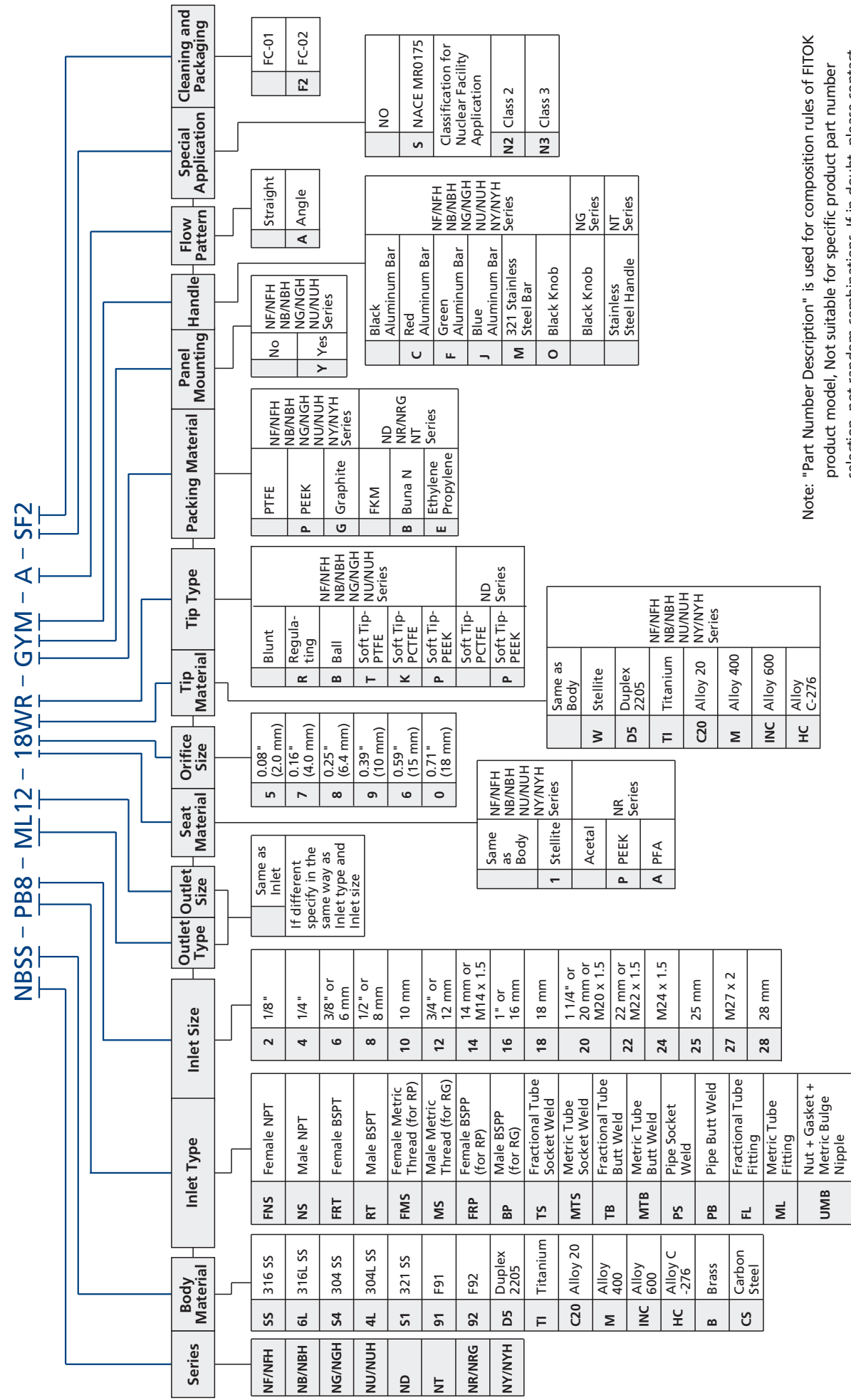

Note: "Part Number Description" is used for composition rules of FITOK product model, Not suitable for specific product part number selection, not random combinations. If in doubt, please contact FITOK group or authorized agent.

Plug Valves

PV Series

- Working pressure up to: 3000 psig (207 bar)
- Working temperature: -10°F to 400°F (-23°C to 204°C)
- Size from 1/8" to 3/4" and 6 to 12 mm
- Orifice sizes: 2.4 mm, 4.4 mm, 7.2 mm
- Body materials: 316 SS, 304 SS, and brass
- Seal materials: Fluorocarbon FKM, Buna N, Ethylene propylene, Neoprene, and Kalrez
- Easy to maintain and clean
- Low operating torque
- Replaceable plug assembly
- Handle as indicator of flow direction
- Handle of different colors available for option
- Positive handle shutoff
- Leak-tight performance testing for every valve with nitrogen at the maximum working pressure



Part Number Description

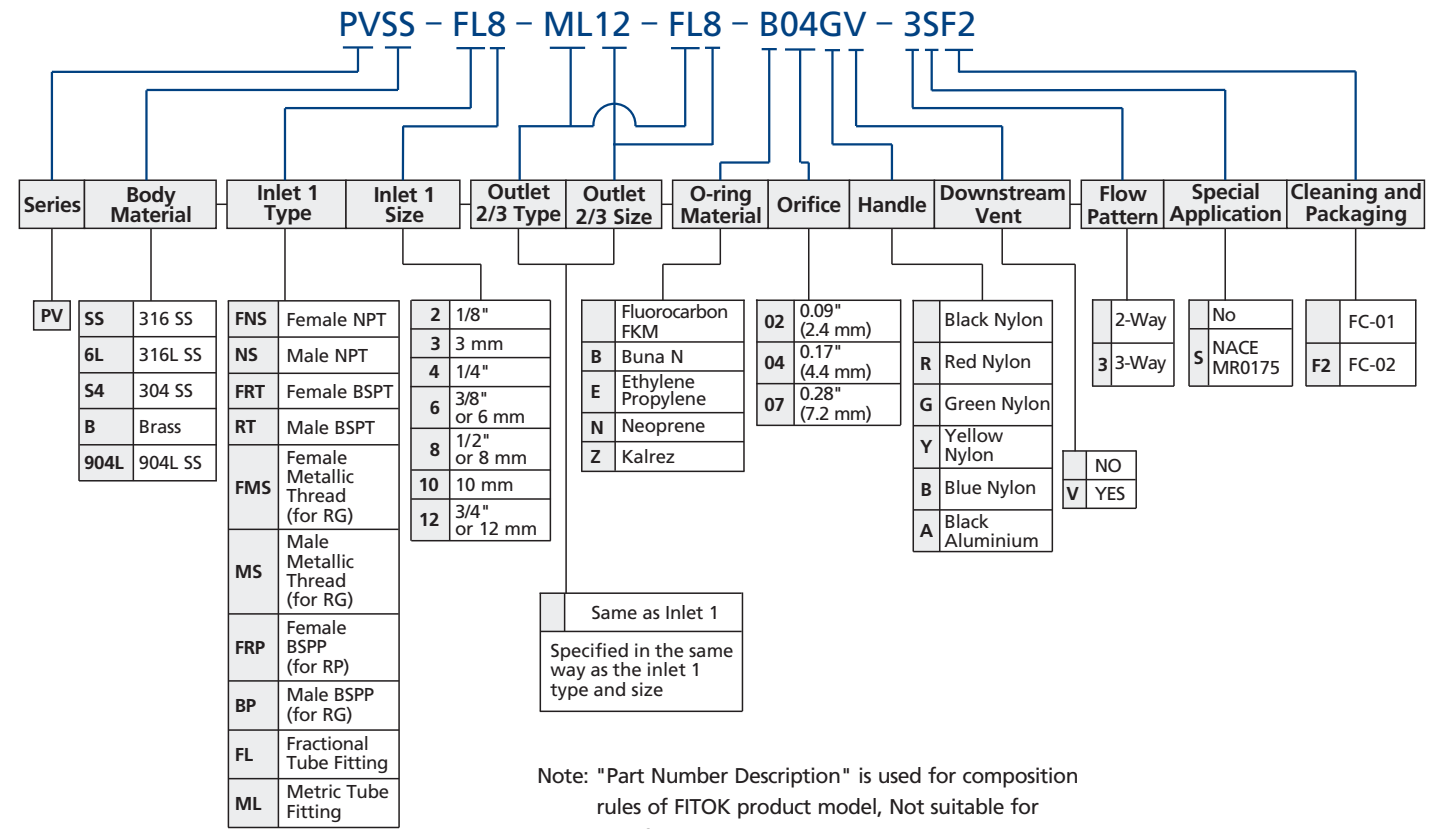

Note: "Part Number Description" is used for composition rules of FITOK product model, Not suitable for specific product part number selection, not random combinations. If in doubt, please contact FITOK group or authorized agent.

Two-Piece Forged Metal-Seated Ball Valves

BM Series

- Size: NPS 1/2 ~ NPS 2 (DN 15 ~ DN 50)
- Classes: 150 ~ 2500

Specifications

- Design: ASME B16.34
- Testing: ASME B16.34 and API 598
- Marking: MSS-SP-25
- Socket weld ends: ASME B16.11
- Butt weld ends: ASME B16.25

Features

- Two-piece forged body designs.
- Ball and seats mate-lapped for 100% contact ensures absolute shutoff.
- Free floating ball design provides seat wear compensation.
- The ball is forced to load into the seat by a high-strength Belleville spring.
- Advanced HVOF custom trim coating technology with hardness in excess of 900Hv.
- An advanced packing chamber design and live-loading provide long lasting, maintenancefree, stem packing tightness.
- Flow arrow forged into mounting flange visible above insulation.
- Low operating torque.
- Blowout-proof stem.
- Positive handle stop.

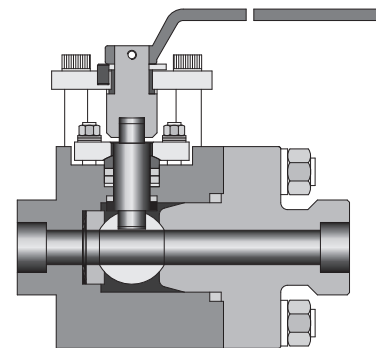

Part Number Description

BMSS - PS8G

Series	Body Material	Type of Connection	Size of Connection	Class
BM	CS A105 22 F22 91 F91 SS F316	PS Pipe Socket Weld PB Pipe Butt Weld	8 NPS 1/2 (DN 15) 12 NPS 3/4 (DN 20) 16 NPS 1 (DN 25) 20 NPS 1 1/4 (DN 32) 24 NPS 1 1/2 (DN 40) 32 NPS 2 (DN 50)	A 150 CL B 300 CL C 600 CL E 900 CL F 1500 CL G 2500 CL

Note: "Part Number Description" is used for composition rules of FITOK product model, Not suitable for specific product part number selection, not random combinations. If in doubt, please contact FITOK group or authorized agent.

Globe Valves

SY Series

- Size: NPS 3/8 ~ NPS 1 (DN 10 ~ DN 25)
- Classes: 2500 and 4500

Specifications

- Design: ASME B16.34
- Testing: ASME B16.34 and API 598
- Marking: MSS-SP-25
- Socket weld ends: ASME B16.11
- Butt weld ends: ASME B16.25



Features

- One-piece, forged, bonnetless globe valves eliminate the potential for body-to-bonnet joint leakage, and not require cut or disassemble the bonnet for servicing.
- 65° inclined body reduces pressure drop compared with T-type.
- Splined bushing guides the stem allows quick and easy maintenance by removing all working parts at one time.
- The non-rotating stem hardened and polished to reduce operating torque.
- Linearly instead of helical movement of the non-rotating stem reduces the total friction area between the packing and stem.
- Packing chamber burnished and combination graphite rings individually pre-stressed for tight seal.
- Two-piece gland ensures gland and packing self-aligning.
- Stellite disc, seat and backseat provide excellent long service life even in severe services.
- Fully guided disc assures seat and disc precise alignment in spite of side thrust caused by high velocity flow, and prevents stem from scoring and galling, and provides longer disc seal and body life.
- Double orifice design Protects seating faces because part of the erosive flow energy dissipates through disc.
- Two flat slots design at the internal bottom of the disc prevent the disc from rotating, so avoid high-speed rotating disc and seat contact, damage to disc and seat.
- Backseat bevel on the stem, not on the disc, meet specifications API-602.
- Large clearance between stem and disc allows disc to move freely.
- Dust cover and sleeve protect stem threads from dirt, dust and sand.
- Fully enclosed stem driving lubrication system with two needle roller bearings ensures low operating torque.
- Upper stem position indicates if valve is open or closed.
- Optional live-loading packing, disc springs keep packing tight for long periods of time without maintenance.
- Stop, regulating, and stop check discs are available.
- Handwheel is rugged and knobbed to make sure the grip even when wearing gloves.
- Optional handwheel colors are available.

Part Number Description

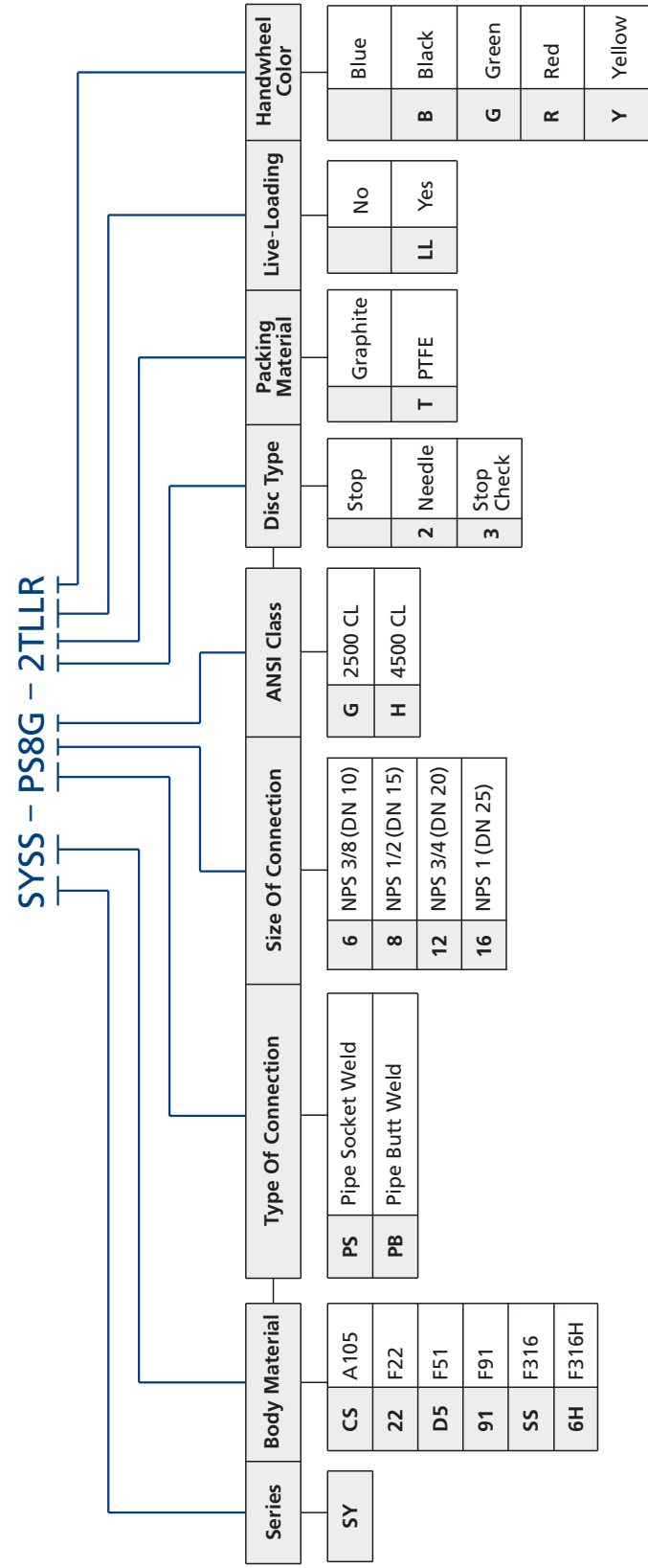

Note: "Part Number Description" is used for composition rules of FITOK product model, Not suitable for specific product part number selection, not random combinations. If in doubt, please contact FITOK group or authorized agent.

Manifolds

Air Headers and Distribution Manifolds

- Distribution lines and drain ports with ball valves, plug valves, and needle valves.
- Red, green, yellow, and blue handles are available.
- Main lines: NPS2
- Connections:
 - Inlet ports: 1" ASME, EN and GB flange
1 pipe thread
 - Outlet ports: 1/4 or 1/2 pipe thread
1/2" or 12 mm tube fitting
 - Drain ports: 1/4 or 1/2 pipe thread
- Quantity of branches: 4 to 16
- Materials: 316 SS, 304 SS
- Each manifold is hydraulic tested with pure water at 1.5 times the design pressure, and leak - tight tested with nitrogen at the design pressure.

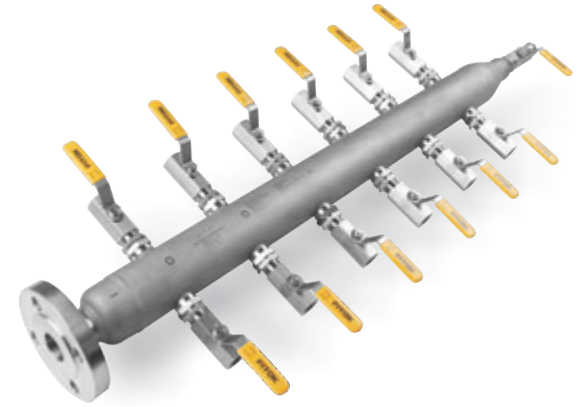

Air Headers

AP Series

- Distribution ports are BR series ball valves.
- The main line is pipe (Sch 10).
- Working pressure up to: 1000 psig (69.0 bar)
- Working temperature: -15°F to 450°F (-26°C to 232°C)

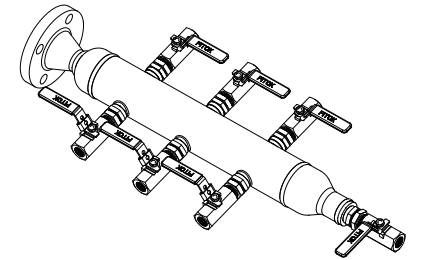

MP Series

- Distribution ports are PV series plug valves.
- The main line is pipe (Sch 160).
- Working pressure up to: 3000 psig (207 bar)
- Working temperature: -15°F to 450°F (-26°C to 232°C)

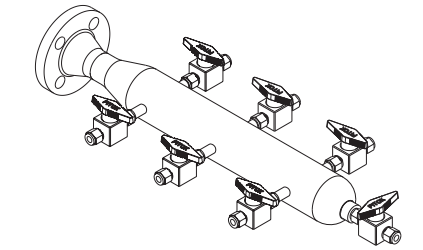

MN Series

- Distribution ports are NB or NF series needle valves.
- The main line is pipe (Sch 160).
- Working pressure up to: 6000 psig (414 bar)
- Working temperature: -15°F to 450°F (-26°C to 232°C)

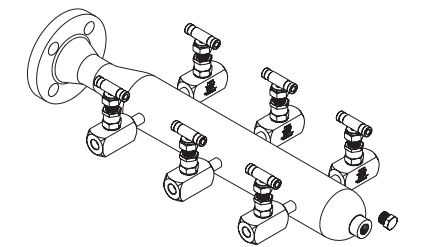

CM Series

- Distribution ports are needle valves.
- The main line is made of pentagon bar.
- Working pressure up to: 6000 psig (414 bar)
- Working temperature: -15°F to 1200°F (-26°C to 649°C)

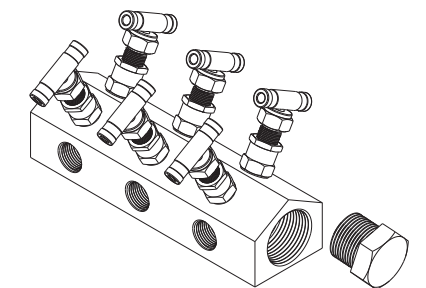

Part Number Description

AP Series

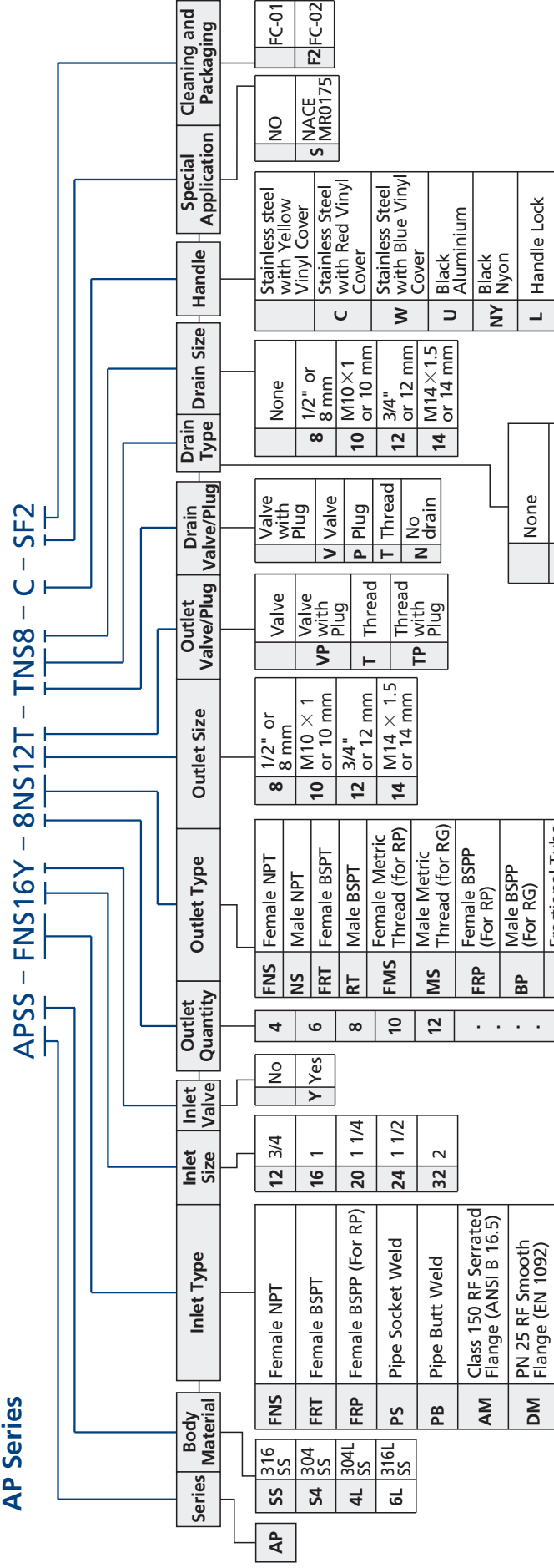

None
FNS Female NPT
NS Male NPT
FRT Female BSPT
RT Male BSPT
FMS Female Metric Thread (for RP)
MS Male Metric Thread (for RG)
FRP Female BSPP (For BP)
BP Male BSPP (For RG)
FL Fractional Tube Fitting
ML Metric Tube Fitting

Note: "Part Number Description" is used for composition rules of FITOK product model, Not suitable for specific product part number selection, not random combinations. If in doubt, please contact FITOK group or authorized agent.

Cleaning and Packaging:

FC-01: Standard cleaning and packaging for general industrial procedures.

FC-02: Special cleaning and packaging for wetted system components to ensure compliance with product cleanliness requirements as stated in ASTM G93 Level C.

MP, MN Series

MNSS – FNS16Y – 10NS8T – BFNS8 – C – SF2

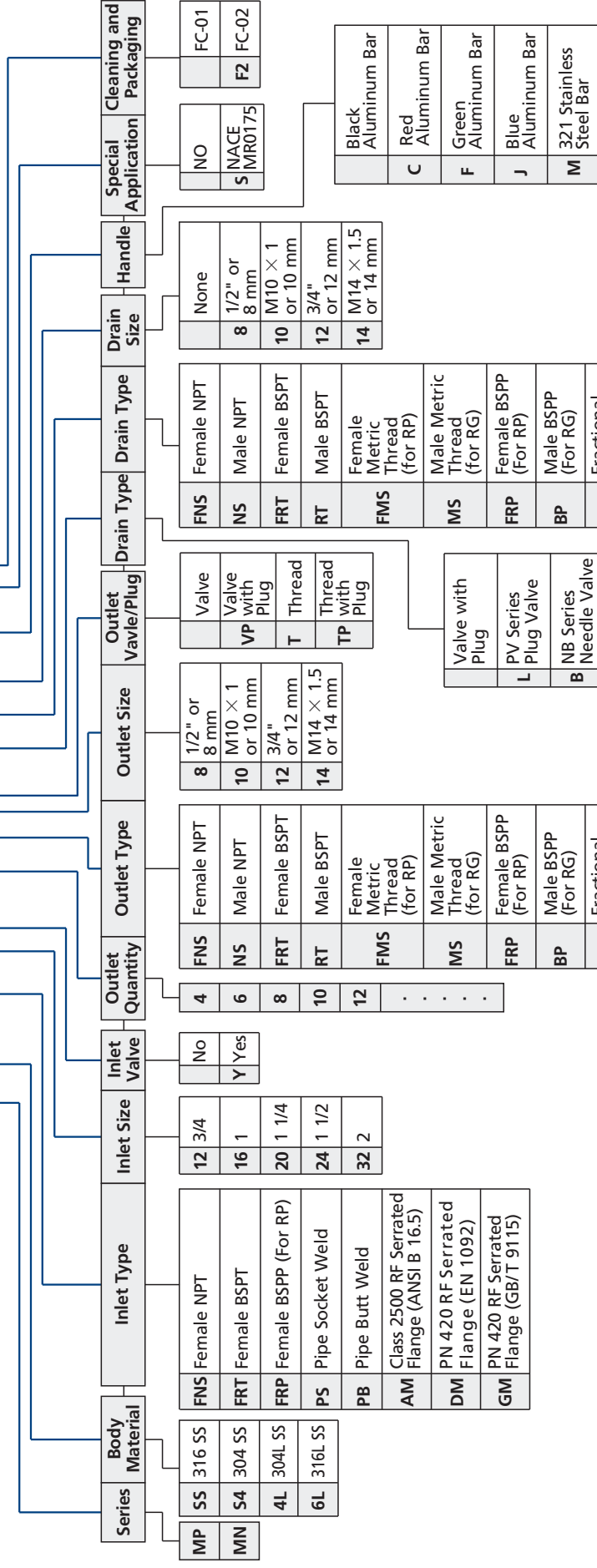

Note: "Part Number Description" is used for composition rules of FITOK product model, Not suitable for specific product part number selection, not random combinations. If in doubt, please contact FITOK group or authorized agent.

Cleaning and Packaging:

FC-01: Standard cleaning and packaging for general industrial procedures.

FC-02: Special cleaning and packaging for wetted system components to ensure compliance with product cleanliness requirements as stated in ASTM G93 Level C.

CM Series

CMSS – FNS16 – 8FNS12P – 12T – C – SF2

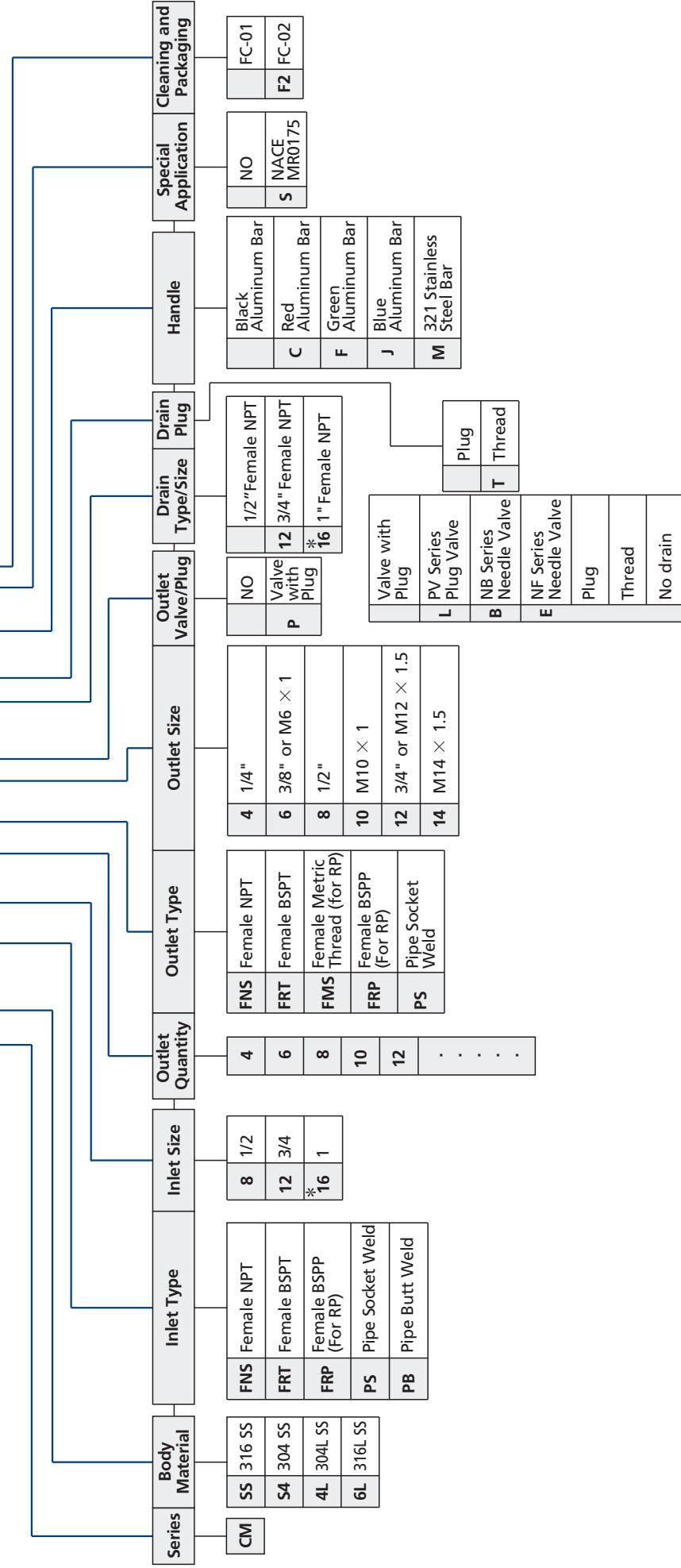

Note: * only applies to maximum working pressure up to 3000 PSI.
 "Part Number Description" is used for composition rules of FITOK product model, Not suitable for specific product part number selection, not random combinations. If in doubt, please contact FITOK group or authorized agent.

Cleaning and Packaging:
 FC-01: Standard cleaning and packaging for general industrial procedures.
 FC-02: Special cleaning and packaging for wetted system components to ensure compliance with product cleaning requirement as stated in ASTM G93 Level C.

Block and Bleed Valves



Element Features

Ball Valves

- Working pressure up to: 6000 psig (414 bar)
- Working temperature:
 PTFE: -65°F to 450°F (-54°C to 232°C)
 PEEK: -65°F to 450°F (-54°C to 232°C)
- Bottom-loaded stem prevents stem blowout and enhances system safety.
- High-strength stem bearings provide smooth actuation and eliminate galling between the valve stem and body.
- FITOK ball valves are designed to be operated in a fully open or fully closed position.

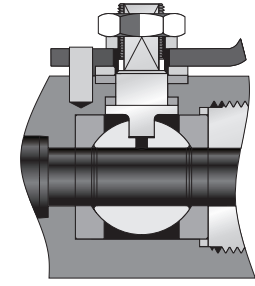

Needle Valves

- Working pressure up to: 6000 psig (414 bar)
- Working temperature:
 PTFE: -65°F to 450°F (-54°C to 232°C)
 Graphite: -65°F to 1200°F (-54°C to 649°C)
- Two stems design. The upper stem has hardened threads, the lower stem has hardened smooth surface.
- Upper stem thread lubricant is isolated from system media.
- The lower stem performs vertical linear movement instead of screwing movement, significantly reducing the friction area.
- The nonrotating lower stem eliminates galling between the seat and tip.
- Stem back seating seals in the fully open position
- Double lock-pins enable steady and durable fastening of the handle.

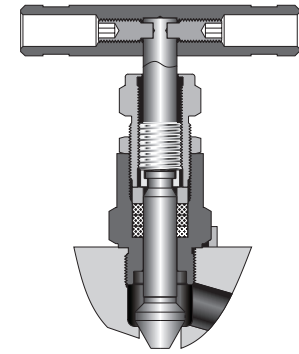

OS & Y Needle Valves

- Working pressure up to: 6000 psig (414 bar)
- Working temperature:
 - PTFE: -65°F to 450°F (-54°C to 232°C)
 - Graphite: -65°F to 1200°F (-54°C to 649°C)
- Two-stem design: thread hardened upper stem and smooth surface hardened lower stem.
- Upper stem thread lubricant is isolated from system fluid.
- The nonrotating lower stem, linearly instead of helical movement, avoids galling damage to the seat and tip, as well as reduces the total friction area between the packing and the lower stem.
- Bolted bonnet enhance strength and reliability.
- Adjustable gland flange allows easy access to the packing gland and packing adjustment for an effective stem seal.
- Investment case yoke is formed by precision casting which enhances strength and perfect stem alignment.
- Two handle pins make the handle fixed firmly and lastingly.

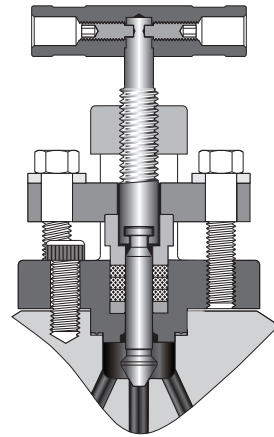

Handle colors indicate functions:

Needle and OS & Y valves: **Black** = Isolate/Block **Red** =Vent/Bleed
 Ball valves: **Yellow**=Isolate/Block **Red** =Vent/Bleed

Single Block and Bleed Valves - BB Series

Instrument Single Block and Bleed Valves

BB□□-BB-FNS8-C	BB□□-BN-FNS8-V	BB□□-NN-NS8-FNS8-H

Flange Single Block and Bleed Valves

BB□□-BN-FM8300-FNS8-V8	BB□□-BB-FM8300-FNS8-V8	BB□□-BN-FM8300-V8	BB□□-BB-FM8300-V8

Root Single Block and Bleed Valves

BB□□-BN-RV8-FNS8-V8	BB□□-BO-RV8-FNS8-V8	BB□□-ON-RV8-FNS8-V8	BB□□-NN-RV8-FNS8-V8

Monoflange Single Block and Bleed Valves

BB□□-ON-MM16600-FNS8-V4	BB□□-NN-MM16600-FNS8-V4	BB□□-ON-MM16600-FNS8-2V4	BB□□-NN-MM16600-FNS8-2V4

Double Block Valves - DB Series

Single Block Valves - SB Series

Monoflange Double Block Valves

DB□□-ON-MM8300-FNS8	DB□□-NN-MM8300-FNS8

Monoflange Single Block Valves

SB□□-O-MM8300-FNS8	SB□□-N-MM8300-FNS8

Double Block and Bleed Valves - DBB Series

Instrument Double Block and Bleed Valves

DBB□□-BBB-FNS8-V4-L	DBB□□-NNN-NS8-FNS8-V4-V	DBB□□-NBN-FNS8-V4-H

DBB□□-BBN-FNS8-V4-V	DBB□□-BBB-FNS8-V4-C

Flange Double Block and Bleed Valves

DBB□□-BBN-FM8600-V4	DBB□□-BBN-FM8600-FNS8-V4	DBB□□-OON-FM8600-V4	DBB□□-OON-FM8600-FNS8-V4

Large-Bore Bolted Double Block and Bleed Valves

DBB□□-BBN-FM16600-V4-F	DBB□□-BBN-FM16600-V4-R

Root Double Block and Bleed Valves

DBB□□-BBN-RV8-FNS8-V8	DBB□□-BBO-RV8-FNS8-V8	DBB□□-OON-RV8-FNS8-V8	DBB□□-NNN-RV8-FNS8-V8

Monoflange Double Block and Bleed Valves

DBB□□-ONN-MM8600-FNS8-V4	DBB□□-NNN-MM8600-FNS8-V4	DBB□□-ONN-MM8600-FNS8-V4-X	DBB□□-NNN-MM8600-FNS8-V4-X
DBB□□-ONN-MM8600-BWE8-V4	DBB□□-NNN-MM8600-BWE8-V4	DBB□□-ONN-MM8600-BWE8-V4-X	DBB□□-NNN-MM8600-BWE8-V4-X

Injection Double Block and Bleed Valves

DBB□□-BBN-FMS8-FE8150-IN

Sampling Double Block and Bleed Valves

DBB□□-BBN-FMS8-FE8150-SA

Part Number Description

DBBSS – 1BBO1 – FM16300 – FNS8 – 2V8 – RPSF2 – IE

Series	Body Material	Options of Needle Valve Orifice	Configuration	Options of Ball Valve Orifice	Inlet Type	Inlet Size	Pressure Ratings	Outlet Type	Outlet Size	Pressure Ratings	Vent Number	Vent Type and Size	Body Style/Function	Packing/Sealing Material	Special Application	Cleaning and Packaging	Special Function
BB	Single Block and Bleed	No Needle Valves Configuration	Primary Needle	No Ball Valves Configuration	FNS Female NPT	4 1/4"	4 1/4"	Same as inlet	4 1/4"	4 1/4"	V4	1/4 Female NPT with plug	Flange and Root pattern	No	No	No	FC-01
DB	Double Block	0.16" (4 mm)	Secondary Needle	3/8" (10 mm)	NS Male NPT	6 3/8" or 6 mm	6 3/8" or 6 mm	Class Series	6 3/8" or 6 mm	6 3/8" or 6 mm	V8	1/2 Female NPT with plug	Compact pattern	NAACE	Fire safe	F2	FC-02
SB	Single Block	0.25" (6.4 mm)	Ball	1/2" (14 mm)	FRT Female BSPT	8 1/2" or 8 mm	8 1/2" or 8 mm	150 Class 150	8 1/2" or 8 mm	8 1/2" or 8 mm	1	One Vent	Valves in-line mounted	5 MR 0175	PTFE	IE	Anti-static
DBB	Double Block and Bleed	0.39" (10 mm)	OS&Y Needle	3/4" (20 mm)	RT Male BSPT	10 10 mm	10 10 mm	300 Class 300	10 10 mm	10 10 mm	2	Two Vents	Valves vertically mounted	PTFE	Fire safe	IE	Anti-static
			Ball	1" (25.4 mm)	ML Metric Tube Fitting	12 3/4" or 12 mm	12 3/4" or 12 mm	600 Class 600	12 3/4" or 12 mm	12 3/4" or 12 mm			Valves horizontally mounted	P PEEK	Fire safe	IE	Anti-static
			OS&Y Needle	1 1/2" (38.1 mm)	FL Fractional Tube Fitting	14 14 mm	14 14 mm	900 Class 900	14 14 mm	14 14 mm			Full-bore three piece bolted mounted	G Graphite	Fire safe	IE	Anti-static
			Ball	2" (50.8 mm)	FMS Female Metric Thread (for Rp)	16 1" or 16 mm	16 1" or 16 mm	1500 Class 1500	16 1" or 16 mm	16 1" or 16 mm			Reduced-bore three piece bolted mounted		Fire safe	IE	Anti-static
			OS&Y Needle		MS Male Metric Thread (for RG)	20 1 1/4" or M20 x 1.5	20 1 1/4" or M20 x 1.5	2500 Class 2500	20 1 1/4" or M20 x 1.5	20 1 1/4" or M20 x 1.5			Block/Block/Bleed		Fire safe	IE	Anti-static
			Ball		UMB Nut+Gasket+Metric Bulge Nipple	24 32"	32 2"	PN Series	32 2"	32 2"			Sampling application		Fire safe	IE	Anti-static
			OS&Y Needle		FM RF Smooth Flange	48 3"	48 3"	6 PN 6	48 3"	48 3"			Injection application		Fire safe	IE	Anti-static
			Ball		FJ RTJ Flange			10 PN 10									
			OS&Y Needle		MM Monoflange			16 PN 16									
			OS&Y Needle		MJ RTJ Monoflange			25 PN 25									
			Ball		RV Root Valve Plain End			40 PN 40									
			OS&Y Needle					63 PN 63									
			OS&Y Needle					100 PN 100									
			Ball					160 PN 160									

Note: "Part Number Description" is used for composition rules of FITOK product model, Not suitable for specific product part number selection, not random combinations. If in doubt, please contact FITOK group or authorized agent.

Gauge Valves

- Working pressure up to:
 - Stainless steel: GV, GR up to 6000 psig (414 bar)
 - GVH up to 10000 psig (690 bar)
- GV series and GVH series working temperature:
 - PTFE packing: -65°F to 450°F (-54°C to 232°C)
 - Graphite packing: -65°F to 1200°F (-54°C to 649°C)
- GR series working temperature:
 - Acetal seat: -20°F to 250°F (-28°C to 121°C)
 - PEEK seat: -20°F to 400°F (-28°C to 204°C)
 - PFA seat: -20°F to 400°F (-28°C to 204°C)
- Non-rotating lower stem, ball tip and plug tip designs
- Variety of materials for seat and packing
- Safety back seating seals in fully open position
- Rolled spindle operating threads
- Lubricant for stem thread isolated from the media
- Externally adjustable gland
- Bonnet locking pin fitted as standard
- Low torque operating T bar handle
- Option for different colored handles
- Steady and durable fastening of the handle by double lock-pins
- Leak-tight performance testing for every valve with nitrogen at the maximum working pressure



Ball Tip Design Valves (GV, GVH)

Plug Tip Design Valves (GR)

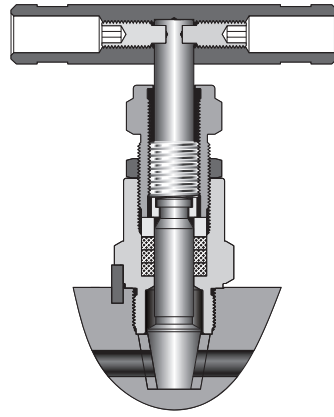
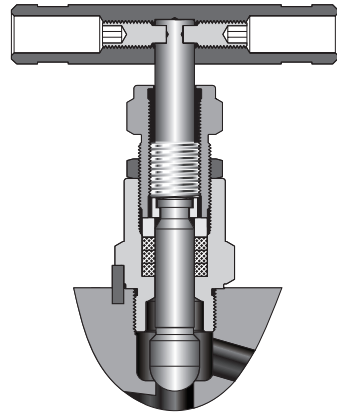

GV □□ -NS8-FNS8 GVH □□ -NS8-FNS8 GR □□ -NS8-FNS8	GV □□ -NS8-FNS8-E GVH □□ -NS8-FNS8-E GR □□ -NS8-FNS8-E	GV □□ -NS8-FNS8-C GVH □□ -NS8-FNS8-C GR □□ -NS8-FNS8-C

Part Number Description

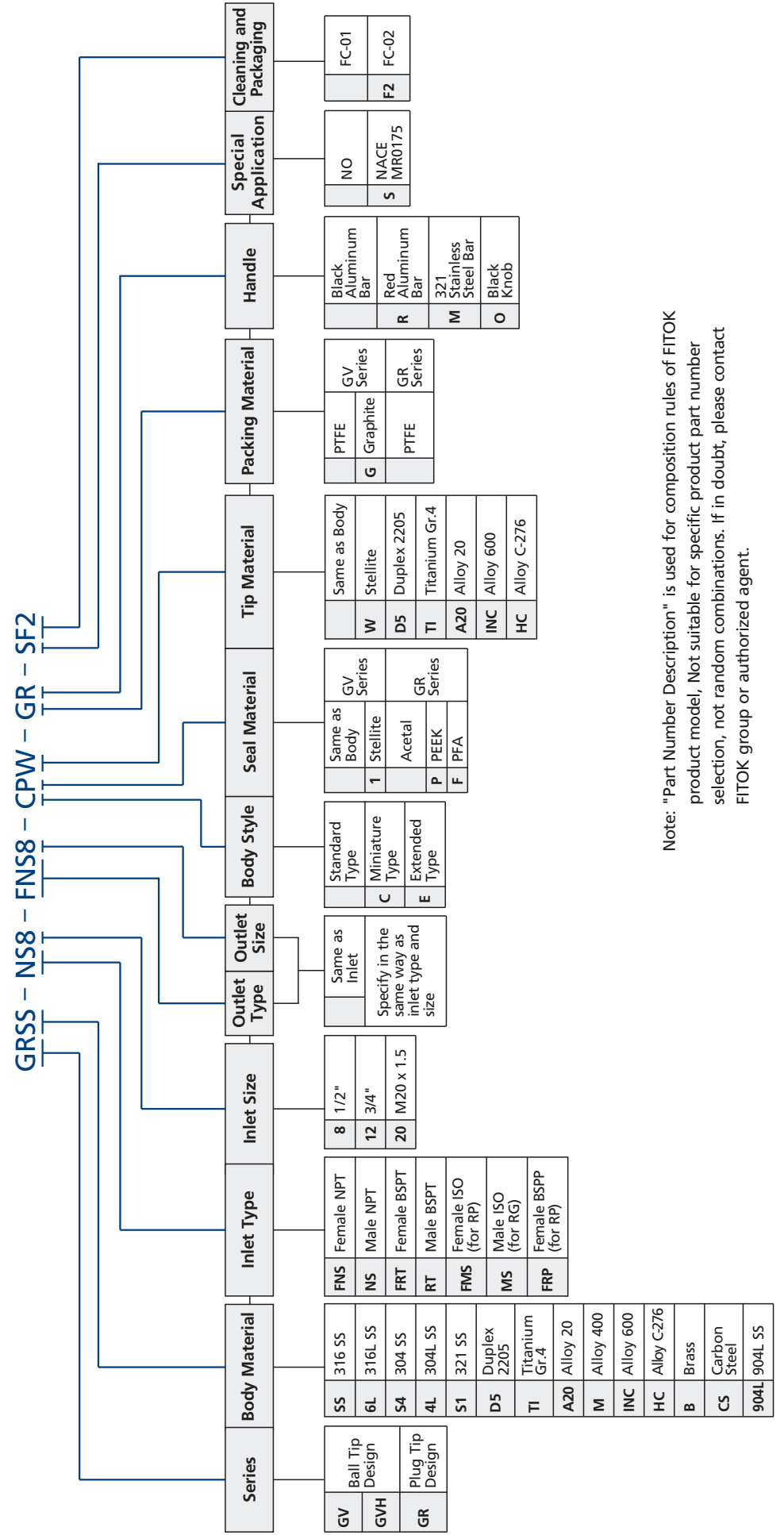

Note: "Part Number Description" is used for composition rules of FITOK product model. Not suitable for specific product part number selection, not random combinations. If in doubt, please contact FITOK group or authorized agent.

Instrumentation Manifolds

- Working pressure up to:
 - Stainless steel: 2D, 2R, 3D, 3R, 5D, 5R up to 6000 psig (414 bar)
 - 2DH, 2RH, 3DH, 3RH, 5DH, 5RH up to 10000 psig (690 bar)
 - Alloy C-276: 2D, 2R, 3D, 3R, 5D, 5R up to 6000 psig (414 bar)
- Working temperature:
 - PTFE packing: -65°F to 450°F (-54°C to 232°C)
 - Graphite packing: -65°F to 1200°F (-54°C to 649°C)
- Orifice: 0.157" (4.0 mm), CV: 0.35
- Two-stem design: thread hardened upper stem and smooth surface hardened lower stem
- Upper stem thread lubricant isolated from system media
- Linear instead of helical movement of the nonrotating lower stem avoids galling damage to the seat and tip, as well as reduces the total friction area between the packing and the lower stem
- Safety back seating seals in fully open position
- Steady and durable fastening of the handle by double lock-pins
- Leak-tight performance testing for every valve with nitrogen at the maximum working pressure



Handle colors indicate functions:

Black=Isolate/Block Red=Test/Vent Green=Equalize

2-Valve Manifolds

2D□□-FNS8-A	2D□□-FNS8-L	2D□□-FNS8-H
2R□□-FNS4-A	2R□□-FNS4-C	2R□□-FNS8-L

2R□□-FNS8-NS8-H	2R□□-FNS8-V	Flow Diagram

The standard configuration of direct mount manifolds contain PTFE flange seal ring and 7/16-20 UNF x 1.75" high tensile bolts.

3-Valve Manifolds

3D□□-FNS8-A	3D□□-FNS8-L-T
3R□□-FNS8-V	Flow Diagram

The standard configuration of direct mount manifolds contain PTFE flange seal ring and 7/16-20 UNF x 1.75" high tensile bolts.

5-Valve Manifolds

5D□□-FNS8-A	5R□□-FNS8-L	Flow Diagram
5D□□-FNS8-B	5R□□-FNS8-B	Flow Diagram

The standard configuration of direct mount manifolds contain PTFE flange seal ring and 7/16-20 UNF x 1.75" high tensile bolts.

Instrumentation Integral Manifolds

© C Integral Manifold is specifically designed for the pressure transmitters of Rosemount® coplanar™, including Model 3051C, 3051P, 2024 and 3095.

2D□□-FNS8-C	3D□□-FNS8-C	5D□□-FNS8-C

© The standard configuration of direct mount manifolds contain PTFE flange seal ring and 7/16-20 UNF x 1.75" high tensile bolts.

Manifold Mounting Brackets

 SS-M2P-2BK		 SS-M2P-4BK	
 SS-M2P-6BK		 SS-M2P-8BK	

Kidney and Eccentric Flanges

Kidney Flange

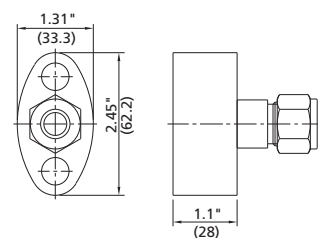

Eccentric Flange

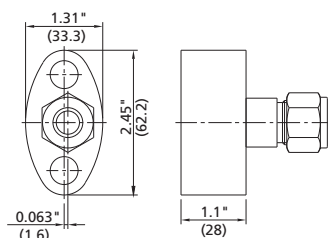

The auxiliary installation for FITOK manifolds and transmitters of different brands

Model of FITOK Manifolds	3(5)DXX-XX-X	3(5)RXX-FXXX-X	2DXX-XXX-X	2RXX-FXXX-X
Model of Transmitters				
Rosemount Transmitters				
3051 CD X X 2 (3, 4, 5, 7, 8) X X X X	A4			
3051 CD X X 0 X X X X H2 (H3, H4, H7, HJ)	A1			
3051 CD X X 0 X X X X HK	A2			
3051 CD X X 0 X X X X HL	A3			
3051 CD X X X X X X DF	A5	A		
3051 CG (CA) X X 2 (3 4 5 7 8) X X X X			A4	
3051 CG (CA) X X 0 X X X X H2 (H3 H4 H7 HJ)			A1	
3051 CG (CA) X X 0 X X X X HK			A2	
3051 CG (CA) X X 0 X X X X HL			A3	
3051 CG (CA) X X X X X X DF			A5	A
1151 D (H) P 3 (4, 5) X XX XX	A1			
1151 A (G) P 3 (4 5) X XX XX			A1	
1151 D (H) P X X XX XX DF	A5	A		
EJA Transmitters				
EJA1X0A-XXX0 (5) X-XXXX	A1			
EJA1X0A-XXX1 (2, 3, 4) X-XXXX	A5	A		
EJA3 (4, 5) X0A-XXX0 (5) X-XXXX			A1	
EJA3 (4 5) X0A-XXX1 (2 3 4) X-XXXX			A5	A
Honeywell Transmitters				
STDXXX-XXA-XXX	A1			
STDXXX-XXH-XXX	A5	A		
STXXX-XXG-XXX			A5	A
STGXXX-XXA-XXX			A1	
SMXXX-XXA-XXX	A1			
SMXXX-XXH-XXX	A5	A		
SIEMENS Transmitters				
7MF433X-XXX0 (4) X-XXXX			A2	A
7MF433X-XXX2 (6) X-XXXX			A1	A
7MF44 (5) 3X-XXX0 (4) X-XXXX	A2			
7MF44 (5) 3X-XXX2 (3, 6, 7) X-XXXX	A1			
7MF44 (5) 3X-XXX1 (5) X-XXXX	A3			

Remark:

- A: Connecting with fittings
- A1: Connecting with flange and sealing rings, using 7/16 - 20 x 1.75" bolts
- A2: Connecting with flange and sealing rings, using M10 x 40 mm bolts
- A3: Connecting with flange and sealing rings, using M12 x 40 mm bolts
- A4: Connecting with flange and sealing rings, using 7/16 - 20 x 3" bolts
- A5: Remove the kidney flanges and then connect with flange and sealing rings

Part Number Description

3DSS – FNS8 – LG – TY1M – SF2

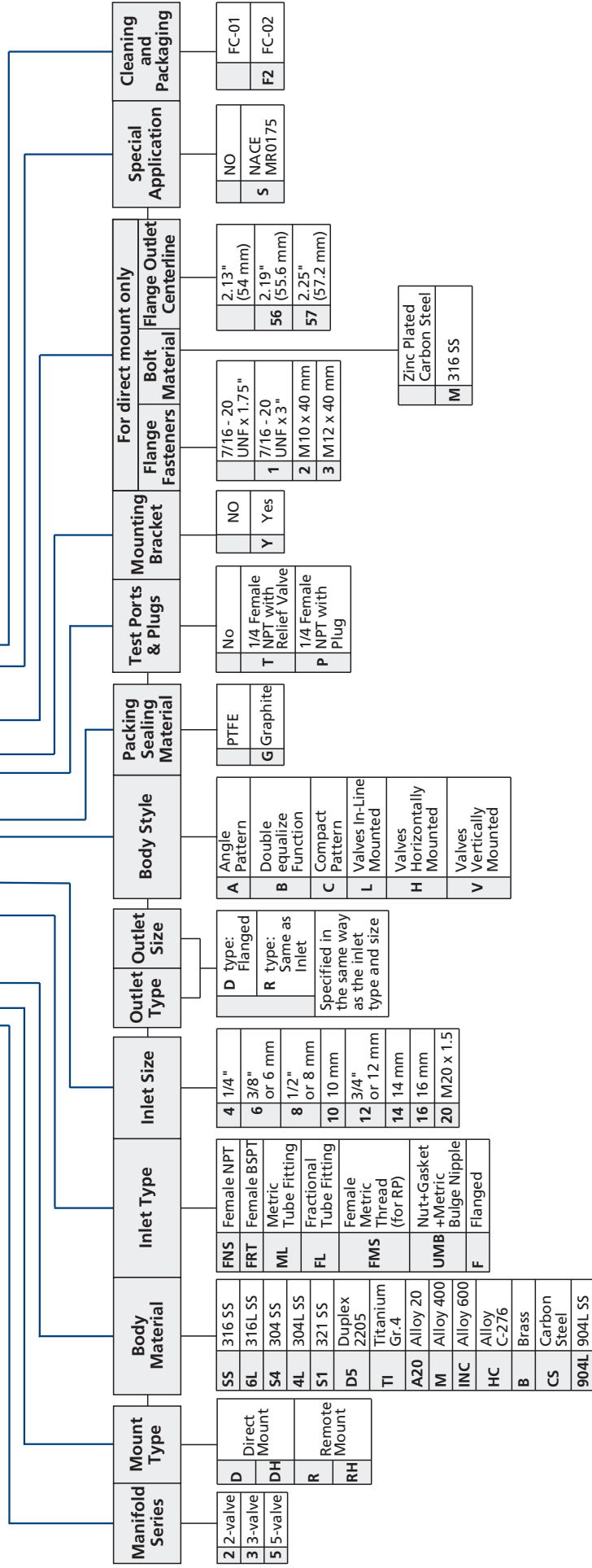

Note: "Part Number Description" is used for composition rules of FITOK product model, Not suitable for specific product part number selection, not random combinations. If in doubt, please contact FITOK group or authorized agent.

Filters



Tee-type Filters

FT Series

- Filter element replaceable without removing body from system
- Union bonnet design
- Nominal pore sizes for sintered element: 0.5, 2, 7, 15, 40, 60 and 80 µm
- Nominal pore sizes for strainer element: 100, 150, 250 and 450 µm
- Working pressure up to: 6000 psig (414 bar)
- Working temperature: -20°F to 900°F (-28°C to 482°C)
- Body materials: 316 SS, 316L SS, 304 SS, 304L SS, 904L SS and Brass
- Variety of end connections available

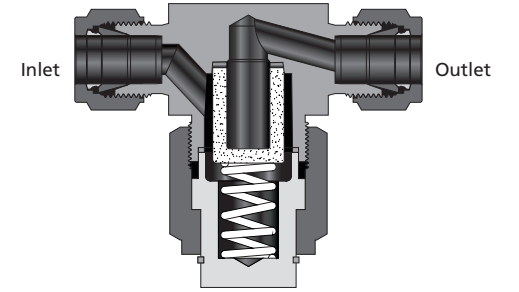

Bypass Filters

FB Series

- Bypass port at filter bottom for the ease of sampling or purging
- Union bonnet design
- Nominal pore sizes for sintered element: 0.5, 2, 7, 15, 40, 60 and 80 µm
- Nominal pore sizes for strainer element: 100, 150, 250 and 450 µm
- Working pressure up to: 6000 psig (414 bar)
- Working temperature: -20 °F to 900 °F (-28 °C to 482 °C)
- Body materials: 316 SS, 316L SS, 304 SS, 304L SS, 904L SS and Brass
- Variety of end connections available

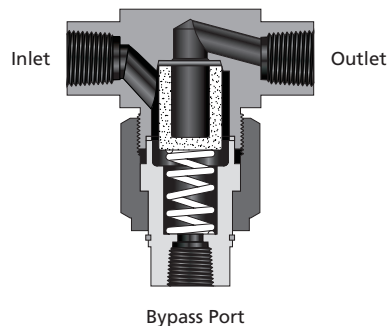

In-line Filters

FI Series

- Compact and space-saving design
- Nominal pore sizes for sintered element: 0.5, 2, 7, 15, 40, 60 and 80 µm
- Nominal pore sizes for strainer element: 100, 150, 250 and 450 µm
- Working pressure up to: 3000 psig (207 bar)
- Working temperature: -20 °F to 900 °F (-28 °C to 482 °C)
- Body materials: 316 SS, 316L SS, 304 SS, 304L SS, 321 SS, 904L SS and Brass
- Variety of end connections available

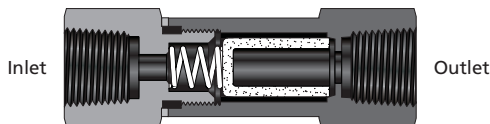

All-welded In-line Filters

FW Series

- Large filtration area and high flow coefficient
- All-welded construction for elimination of leakage
- Easy cleaning of filters by backflushing
- Full-penetration weld between body and element
- Nominal pore sizes for sintered element: 0.5, 2, 7, 15, 40, 60 and 80 µm
- Working pressure up to: 6000 psig (414 bar)
- Working temperature: -20 °F to 900 °F (-28 °C to 482 °C)
- Body materials: 316 SS, 316L SS, 304 SS, 304L SS and 904L SS
- Variety of end connections available

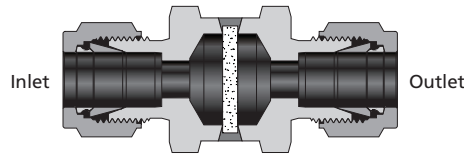

Filters Part Number Description

FBSS – FL8 – ML10 – S – P150 – FL4SF2

Series	Body Material	Inlet Type	Inlet Size	Outlet Type	Outlet Size	Element Type	Gasket Material	Element Nominal Pore Size	Bypass Port (for FB Series Only)	Special Application	Cleaning and Packaging
FT	316 SS	FNS Female NPT	2 1/8"	Same as Inlet	Same as Inlet	Sintered	Silver-plated 316 SS for FT, FB, FI	05	1/8" Female NPT	NO	FC-01
FB	316L SS	MS Male NPT	4 1/4"	Specified in the same way as the inlet type and size	Specified in the same way as the inlet type and size	S Strainer	PTFE-plated 316 SS for FT, FB, FI	2	1/8" Fractional Tube Fitting	NACE S MR0175	FC-02
FI	304 SS	FRT Female BSPT	6 3/8" or 6 mm					7	1/4" Fractional Tube Fitting		F2
FW	304L SS	RT Male BSPT	8 1/2" or 8 mm					15	1/4" Tube Socket Weld		
	321 SS	FMS Female Metric Thread (for RP)	10 mm					40	3/8" Fractional Tube Fitting		
	Brass	MS Male Metric Thread (for RG)	12 3/4" or 12 mm					60	1/2" Fractional Tube Fitting		
	904L 904L SS	FRP Female BSPP Thread (for RP)	14 14 mm or M14 x 1.5					80			
		BP Male BSPP (for RG)	16 1" or 16 mm					100			
		FL Fractional Tube Fitting	18 18 mm					150			
		ML Metric Tube Fitting	20 1 1/4" or 20 mm or M20 x 1.5					250			
		TS Fractional Tube Socket Weld	22 22 mm or M22 x 1.5					450			
		TB Fractional Tube Butt Weld	25 25 mm								
		FR Male FR Fitting									

Note: "Part Number Description" is used for composition rules of FITOK product model, Not suitable for specific product part number selection, not random combinations. If in doubt, please contact FITOK group or authorized agent.

Hoses and Connectors

Metal Flexible Hose Assemblies

MH, MM Series

- Core tube and fitting material: 316 stainless steel
- Overbraid material: 304 stainless steel
- Working pressure up to: 3100 psig (213 bar)
- Hose sizes: 1/4" to 2"
- Working temperature: -325°F to 800°F (-200°C to 426°C)
- End connections:
 - 1/4 to 2 thread
 - 1/4" to 2" and 6 mm to 22 mm tube fitting
- Welded fitting-to-hose construction to ensure reliable seal
- Standard and custom-length available



PTFE-lined, Stainless Steel Braided Hose Assemblies

PS Series

- Lightweight construction for easy handling and installation
- Core tube material: smooth virgin PTFE
- Overbraid material: 304 stainless steel
- Working pressure up to: 3000 psig (207 bar)
- Hose sizes: 1/4" to 1"
- Working temperature: -65°F to 400°F (-53°C to 204°C)
- End connections:
 - 1/8 to 1 thread
 - 1/8" to 1" and 6 mm to 22 mm tube fitting
- Standard and custom-length available



Thermoplastic Hose Assemblies

TH Series

- Cover: polyurethane for resistance to oil, weather and abrasion
- Reinforcement: double-braid high-strength synthetic fiber
- Core tube: nylon
- Working pressure up to: 5000 psig (345 bar)
- Hose sizes: 3/16" to 1"
- Working temperature: -40°F to 200°F (-40°C to 93°C)
- End connections:
 - 1/4 to 1 thread
 - 1/4" to 1" and 6 mm to 22 mm tube fitting
- End connection materials: stainless steel, brass, and carbon steel
- Standard and custom-length available



Multipurpose Push-on Hose Assemblies

MP Series

- Cover: weather-, abrasion-, and oil-resistant synthetic rubber
- Reinforcement: single-braid high-strength synthetic fiber woven for maximum strength and end connection retention
- Core tube: highly oil-resistant rubber
- Hose colors: blue, black, green, gray, red and yellow
- Working pressure up to: 300 psig (20.7 bar)
- Hose sizes: 1/4" to 3/4"
- Working temperature: -40°F to 190°F (-40°C to 88°C)
- End connections:
 - 1/4 to 3/4 thread
 - 1/4" to 3/4" and 6 mm to 18 mm tube fitting
- End connection materials: stainless steel and brass
- End connections reusable
- Standard and custom-length assemblies



Hose Part Number Description

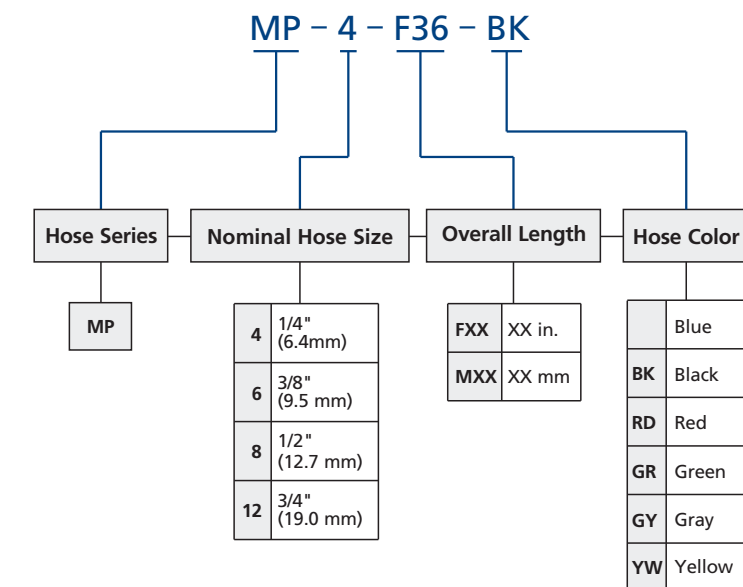

Example: **MP-8-F60-BK**
MP: Hose series
8: Hose size is 1/2"
F60: Overall length is 60"
BK: Hose color is black

Note: "Part Number Description" is used for composition rules of FITOK product model, Not suitable for specific product part number selection, not random combinations. If in doubt, please contact FITOK group or authorized agent.

Part Number Description

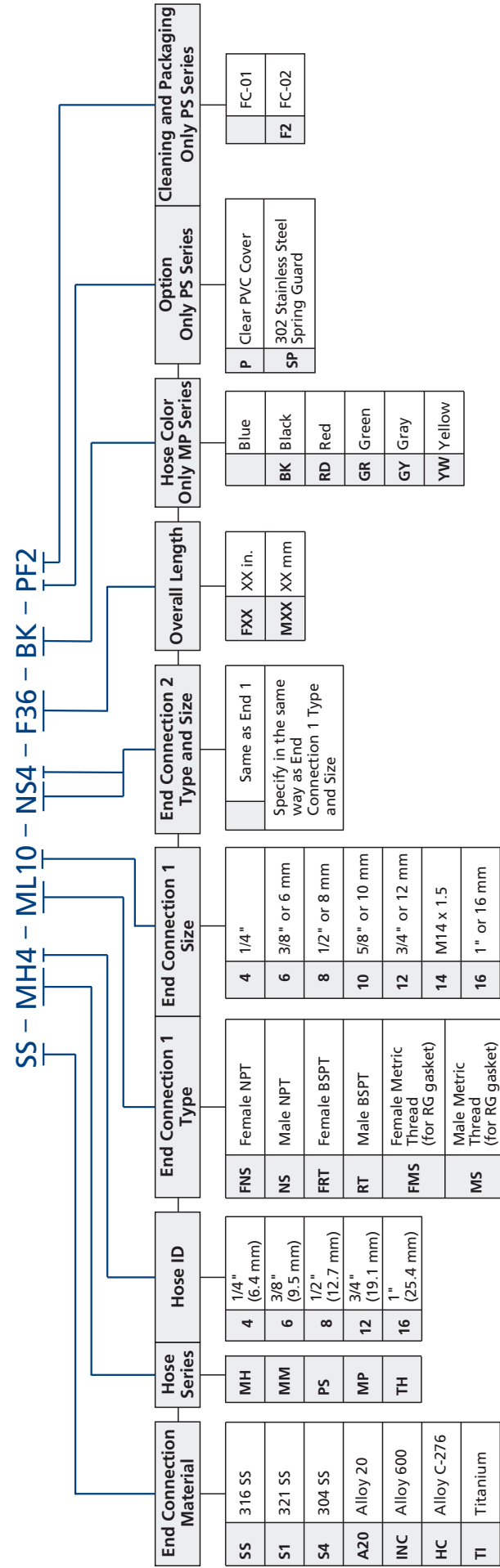

Note: "Part Number Description" is used for composition rules of FITOK product model, Not suitable for specific product part number selection, not random combinations. If in doubt, please contact FITOK group or authorized agent.

- Options and accessories do not change hose technical data. Hose operating parameters must be considered when selecting a cover.
- Clear PVC cover resists abrasion.
- 302 stainless steel spring guard covers entire hose to protect against kinking and abrasion.
- To order a hose assembly with special cleaning and packaging (FC-02), following ASTM G93 level C, add -F2 as a suffix to the ordering number.

Example: SS-PS4-FT4-F24-F2.

End 1 and end 2 follow the orders and regulations below:

- Metric Double Ferrules - Fractional Double Ferrules - Metric Tube Adapters - Fractional Tube Adapters - NPT Threads - BSPT Threads - BSPP Threads - SAE/MS Parallel Threads - 37° Flare - Others
- Put the sizes from the biggest down to the smallest if they are of the same type.
- Put the female before male if they are of the same type and size.

Hose Connectors, Adapters, and Sleeves

HC Series

- For connecting with soft plastic or rubber tubing
- Working pressure and temperature range is higher than the corresponding connecting hose.
- Stainless steel or brass material
- Shank design for secure holding of tubing inside diameter
- Hose connectors reusable



Part Number Description

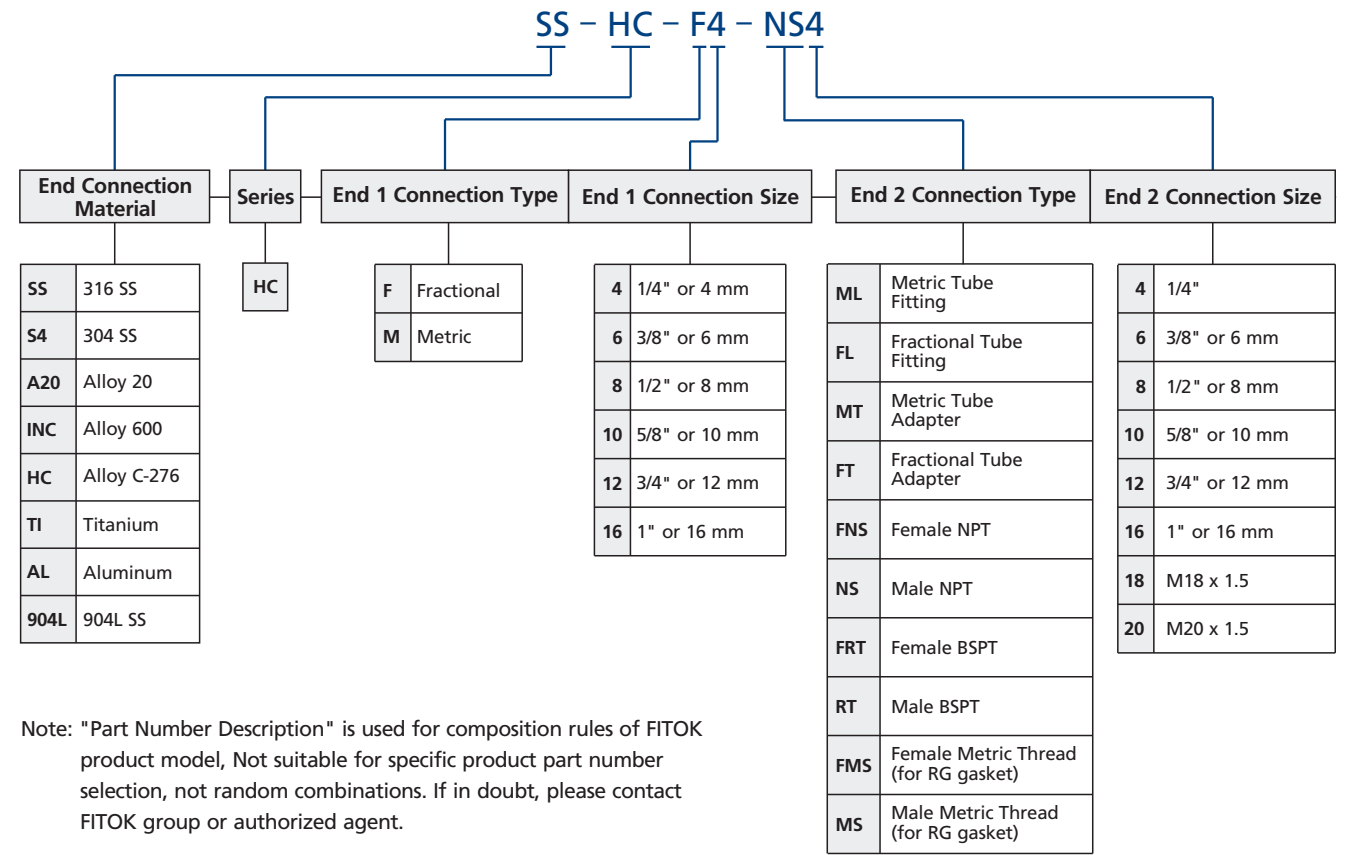

Note: "Part Number Description" is used for composition rules of FITOK product model, Not suitable for specific product part number selection, not random combinations. If in doubt, please contact FITOK group or authorized agent.

Quick-connects

QC Series

- Working pressure up to: 3000 psig (207 bar)
- Working temperature:
 - 10°F to 400°F (-23°C to 204°C) with Fluorocarbon FKM seal
 - 10°F to 250°F (-23°C to 121°C) with Buna N seal
- Materials: stainless steel or brass
- End connections: 1/8 to 1/2 NPT, 1/8" to 1/2" and 6 mm to 12 mm tube fitting and 1/4" to 1/2" hose connectors
- Reliable, leak-tight O-ring seals for vacuum or pressure systems
- Mix-interchangeable with other main brands
- Single-end shutoff, double-end shutoff and full-flow quick-connects available
- Simple push-to-connect coupling for quick and easy operation
- Sturdy locking mechanism with large contact area to ensure reliable stem retainment



QF Series

- Working pressure up to: 6000 psig (414 bar)
- Working temperature:
 - 10°F to 400°F (-23°C to 204°C) with Fluorocarbon FKM seal
 - 10°F to 250°F (-23°C to 121°C) with Buna N seal
- Materials: stainless steel, carbon steel and brass
- End connections: 1/4 to 1 NPT, 1/4" to 1" and 6 mm to 12 mm tube fitting
- Full flow
- Quick, easy operation
- Smooth, open bores without valving on either end to minimize pressure drop and allow easy cleaning



QV Series

- Working pressure up to: 2000 psig (137 bar)
- Working temperature:
 - 10°F to 400°F (-23°C to 204°C) with Fluorocarbon FKM seal
 - 10°F to 250°F (-23°C to 121°C) with Buna N seal
- Materials: stainless steel, carbon steel and brass
- End connections: 1/8 to 1 NPT and BSPT
- Double-end shutoff available
- Durable ball-locking mechanism assures reliable connection
- Simple push-to-connect coupling for quick and easy operation



QM Series

- Working pressure up to: 4000 psig (276 bar)
- Working temperature:
 - 10°F to 400°F (-23°C to 204°C) with Fluorocarbon FKM seal
 - 10°F to 250°F (-23°C to 121°C) with Buna N seal
- Materials: stainless steel or brass
- Single-end shutoff, double-end shutoff and full-flow available
- Quick, easy operation



Part Number Description

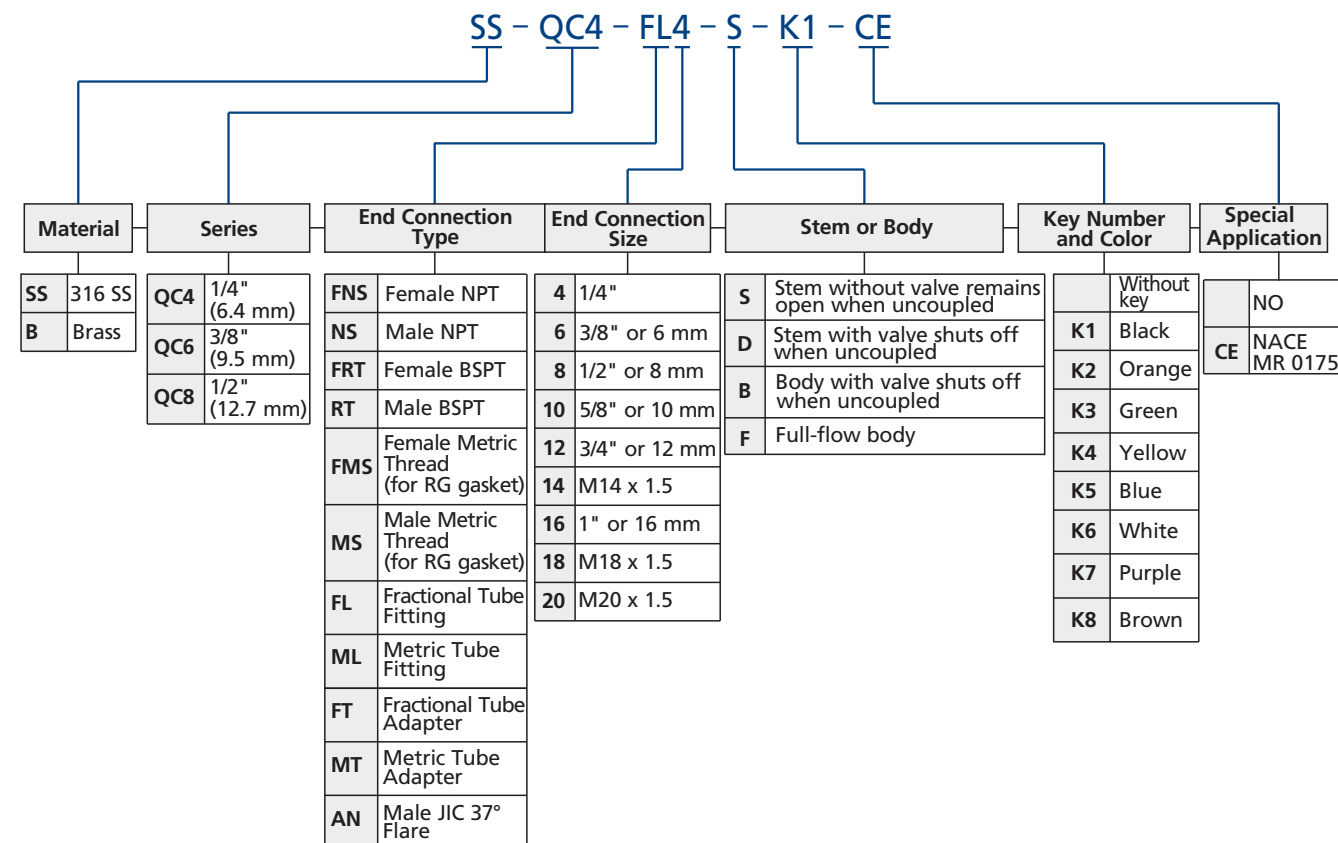

Condensate Pots and Vessels

Condensate Pots

CP Series

- Working pressure up to: Class 2500
- Socket weld connection as per ANSI B16.11
- Butt welding ends as per ANSI B16.9
- NPT as per ANSI B1.20.1 taper pipe thread
- All chambers are factory tested fully prior to shipment
- Standard material of construction: 316 SS, 304 SS, carbon steel
- Pipe schedule: 40, 80, 160, XXS seamless steel
- Variety of end connections available



Configurations

2A	2B	3A	3B	3C	4A

Vessels

SV Series

- Pressure ratings range class 300 to 2500
- Outside diameters: NPS 3 and NPS 4
- Full-penetration gas tungsten arc-weld construction ensures great strength and leak-tight performance
- All vessels are cleaned in compliance with FITOK standard clean procedure. The connections are protected with caps or plugs
- Each vessels is hydraulic tested with pure water at 1.5 times the design pressure, and leak-tight tested with nitrogen at its design pressure



Configurations

CV1	CV2	SV1	SV2	IV1	IV2

Part Number Description

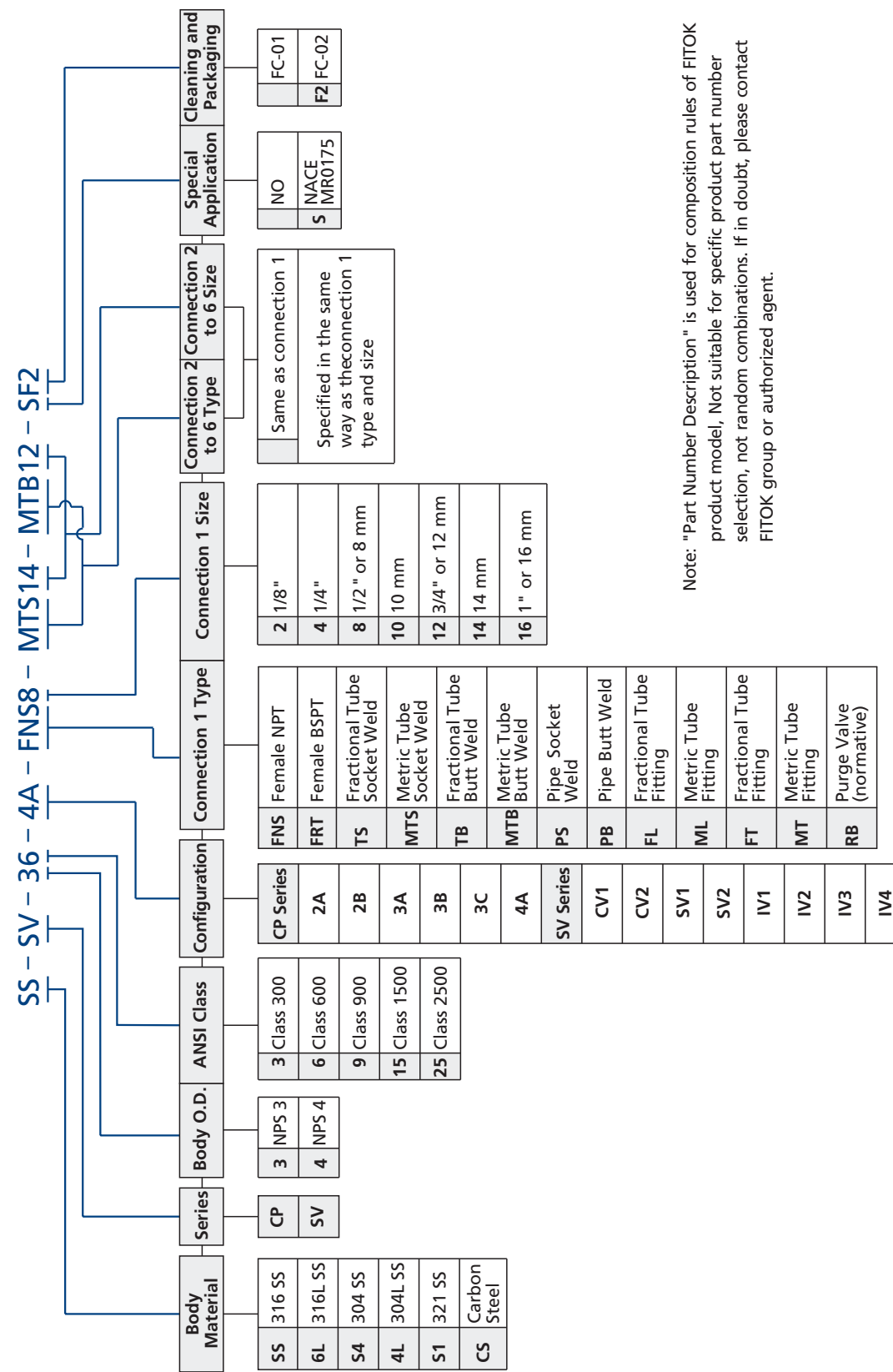

Sample Cylinders and Accessories

SC Series

- Working pressure up to: 5000 psig (345 bar).
- Volume varies from 40 to 3785 cm³.
- 304L and 316L and alloy 400 stainless steel materials resist intergranular corrosion.
- Seamless tubing body provides consistent wall thickness, size and capacity.
- Cylinder inlet ends are 1/8, 1/4 and 1/2 female NPT connections.
- Heavy wall end connections provide strength and are flaring-resistant.
- Full-penetration gas tungsten arc-weld construction provides leak-tight sample containment.



MC Series

- Working pressure up to: 1000 psig (69.0 bar)
- Capacity: 10, 25 and 50 cm³
- Single-ended and double-ended designs
- End connection: connected to 3/8" FITOK tube fittings or welded to 1/4" or 3/8" tubing
- Corrosion-resistant stainless steel construction
- Full-penetration butt weld construction

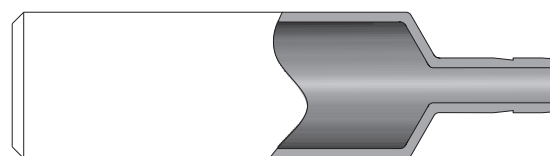

Part Number Description

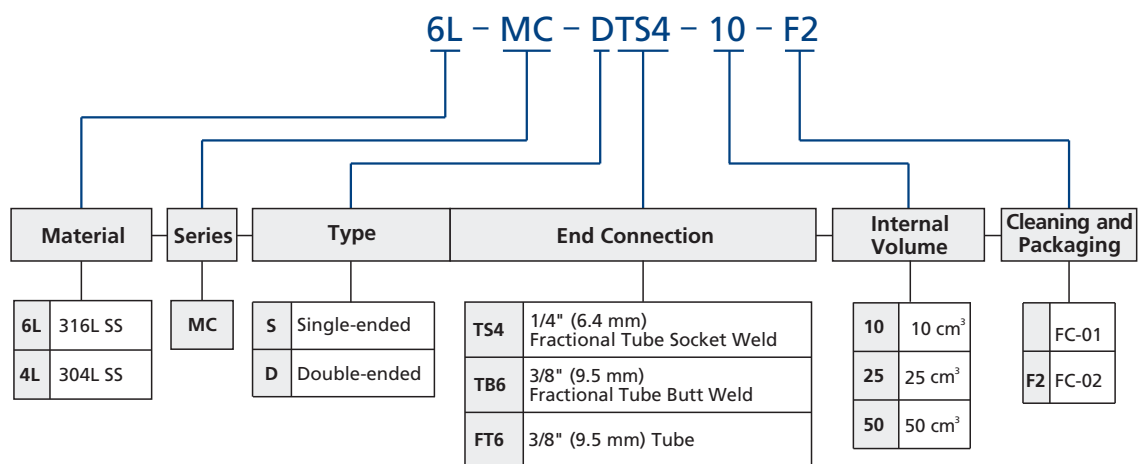

Note: "Part Number Description" is used for composition rules of FITOK product model, Not suitable for specific product part number selection, not random combinations. If in doubt, please contact FITOK group or authorized agent.

Part Number Description

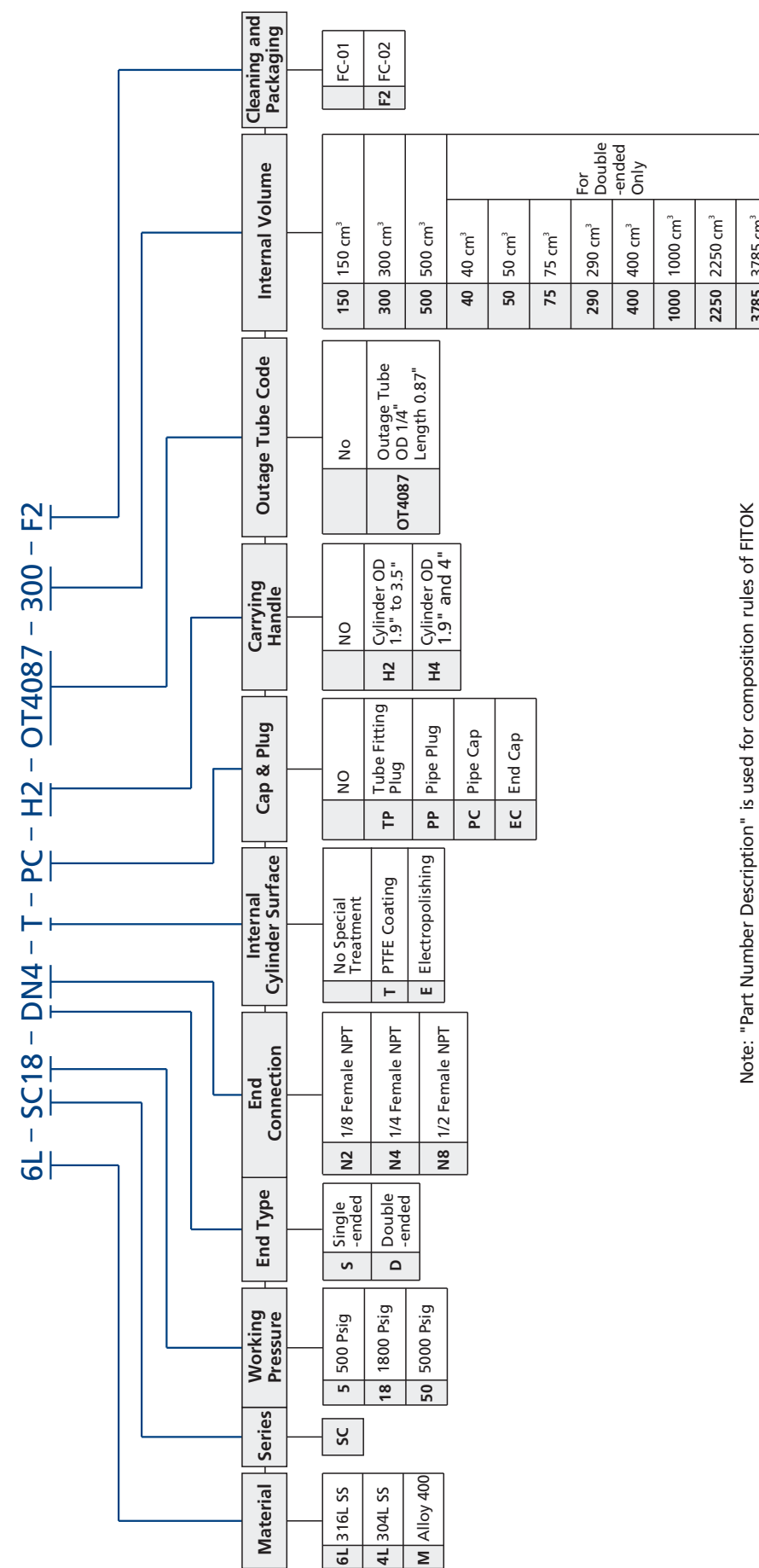

Tubing Tools

Hand Tube Benders

HTB Series

- Can bend stainless steel or copper tubing, the outside diameter ranges from 1/4" to 1/2" and 6 mm to 12 mm
- Roll dies reduce bending force and tube ovality, as compared to conventional slide block design
- 1° to 180° bending range

	Ordering Number	Tube O.D.	Bend Radius
	HTB-4S	1/4"	0.56"
	HTB-4	1/4"	0.75"
	HTB-5	5/16"	0.94"
	HTB-6	3/8"	
	HTB-8	1/2"	1.5"
	HTB-6M	6 mm	15 mm
	HTB-8M	8 mm	24 mm
	HTB-10M	10 mm	
	HTB-12M	12 mm	38 mm
	HTB-14M-L	14 mm	56 mm
	HTB-16M-L	16 mm	

The hand tube bender can not be used for SAF 2507 tubing over 1/4" or for medium-pressure tubing.

Tube Cutters

Ordering Number: FTC-03,FTC-04,FTC-05

- For cutting stainless steel, copper, and aluminum tubing
- For cutting 1/8" to 2 5/8" and 3 mm to 65 mm outside diameter tubing



Tube Deburring Tools

Ordering Number: TDT-01,TDT-03,TDT-05

- For deburring tubing made from stainless steel, carbon steel, aluminium, and copper materials
- For deburring 1/4" to 1 1/4" and 6 mm to 35 mm outside diameter tubing



Hydraulic Presetting Tools

Ordering Numbers: HPT-03 (for 1/2" to 1" and 12 mm to 25 mm tubing)

HPT-05 (for 1 1/4" to 2" and 28 mm to 50 mm tubing)

- For installation of 1/2" to 2" and 12 mm to 50 mm tube fittings
- Used to install carbon steel, stainless steel, and alloy steel tube fittings
- Manually operated hydraulic pump, without requirement for power or compressed air
- Flexible hose connection between the pump and jig to assure easy and comfortable operation
- Sturdy plastic package for easy carrying
- Total weight of 37.5 lbs
- Overall dimensions (without handle) of 12.6 in. x 9.8 in. x 5.9 in.



Manual Presetter Tools

MPT Series

For tube fitting installations in close quarters, the presetter tool can make installation easier when paired with the table vice.

- For 1/4" to 1" and 6 mm to 25 mm tube fittings



Gap Inspection Gauges

GIG Series

During initial installation of tube fittings, installer or inspector can use gap inspection gauge to check whether a fitting has been sufficiently tightened and eliminate the latent danger of leakage for the system.

- For all metal fittings, sizes from 1/16" to 1" and 2 mm to 25 mm



Simple

Individual Sizes

Multiple Sizes

Universal Adapters Cases

- Carefully selected adapters, hoses, and gaskets in one case for convenience
- Customer specified adapters available

Ordering Numbers:

ZR45K-65P: 65 standard pieces inside

ZR45K-65PC: 65 customer specified pieces inside

ZR25K-30P: 30 standard pieces inside

ZR25K-30PC: 30 customer specified pieces inside



Other Elements

Stainless Steel Seamless Tubing



Material Standards

Grade	UNS Designation	ASTM	ASME
316/316L	S31600/S31603	A312	SA312
304/304L	S31400/S31403		
321	S32100		

Example:
 Fractional: 6L-ST8-049-12-MP-A269
 Metric: 6L-ST12M-1.0-2M-MP-A269

Gaskets and O-rings

Configuration	Gasket Type	Example
	RS Gasket	CSB-RS-8
	RP Gasket	CU-RP-6
	RG Gasket	CU-RG-4

Configuration	O-ring Type	Example
	70 durometer NBR	BN7-116
	90 durometer FKM	VI9-912

Syphons



- Working pressures up to: 6000 psig (414 bar)
- Working temperatures up to: 850°F (454°C)
- 316 SS, 304 SS materials are available

Configuration	Type	Example
	WS Series	SS-WS-FNS8-MTB14
	LWS Series	S4-LWS-FNS8-MTB14
	UWS Series	S1-UWS-FNS8-MTB14

Thermowells and Bosses



Thermowells

- FITOK thermowells provide reliable heat-transmission performance under high temperature, high pressure, and corrosive conditions
- Rugged mechanical construction ensures resistance to distortion under sharp temperature fluctuation conditions

- Straight, stepped, and tapered shank designs are available
- Standard instrument connection is 1/2" NPT; other connections are available on request
- Materials: 316 SS, 304 SS, 321 SS, F91, F92, 316H SS, carbon steel, brass, titanium, alloy C-276 and alloy 400

TW Series

Example: SS-TW-FNS8-NS12-ST12-4-4

- Process connections: 1/2" to 1" NPT; other connections available on request
- Working pressure up to: 6000 psig (414 bar)
- Working temperature: -65°F to 1200°F (-54°C to 649°C)

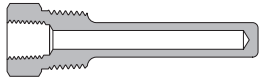

TF Series

Example: SS-TF-FNS8-RF16150-SP12-4-4.5

- Process connection: flange complying with ANSI B16.5
Flange sizes: 1" to 2"
Flange ratings: class 150 to 2500
Flange types: raised face and flat face
- Welded flange-to-body construction

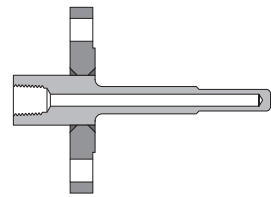

TS Series

Example: SS-TS-FNS8-TP-4-2.5

- Process connection: socket weld
- Working pressure up to: 6000 psig (414 bar)
- Working temperature: -65°F to 1200°F (-54°C to 649°C)

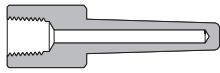

TJ Series

Example: SS-TJ-FNS8-TP-4-11.8

- Process connection: flange
- Flange complying with ANSI B16.5
- Working pressure up to: 6000 psig (414 bar)
- Working temperature: -65°F to 1200°F (-54°C to 649°C)

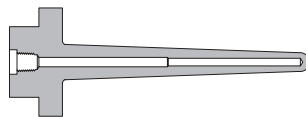

Part Number Description

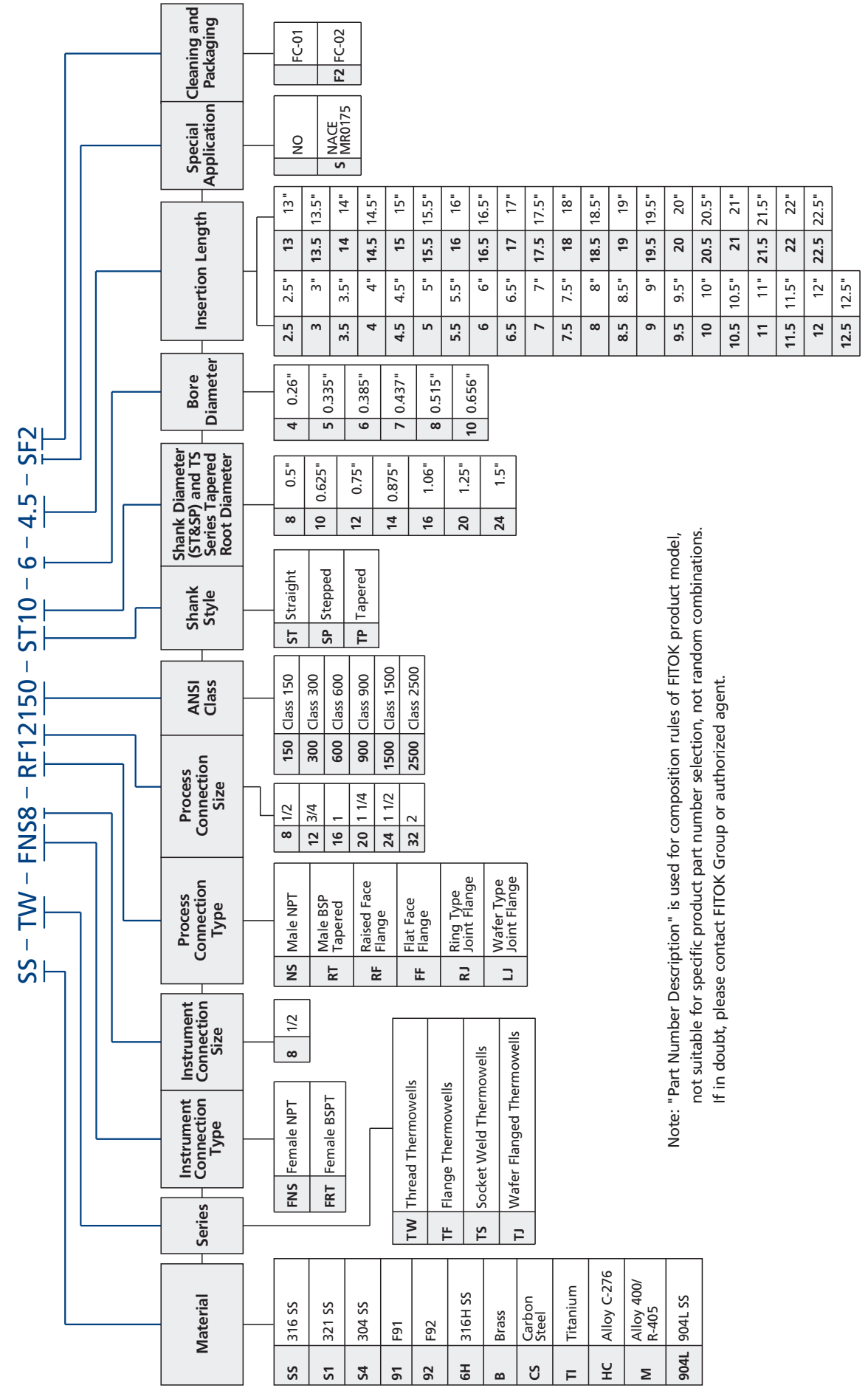

Bosses

BS Series

- Variety of process connection types and sizes available on request
- Working pressure up to: 1500 psig (104 bar)
- Instrument connections: M12 x 1.5 to M33 x 2.0, and 1/2 to 1 thread
- Materials: 316 SS, 304 SS, 321 SS, carbon steel, brass, titanium, alloy C-276, and alloy 400/R-405

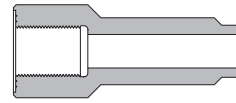

Example: SS-BS-FMS27-17-40-120

Part Number Description

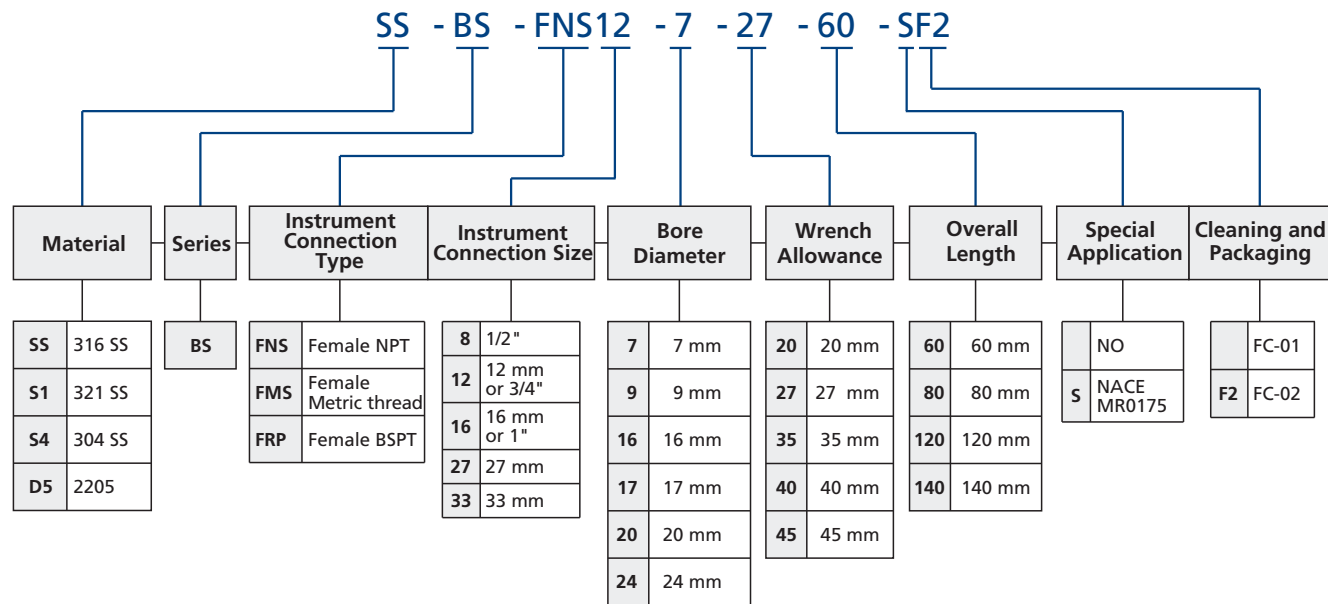

Note: "Part Number Description" is used for composition rules of FITOK product model, not suitable for specific product part number selection, not random combinations. If in doubt, please contact FITOK Group or authorized agent.







Medium & High Pressure Fittings

15 Series Tube Fittings

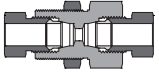
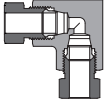
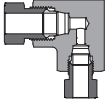
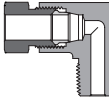
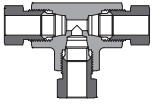
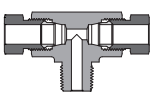
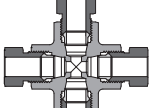
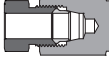

- Pressures up to 15000 psig (1034 bar)
- Fittings are easy to disconnect and retighten
- Every fitting is stamped with size, material and heat code
- Radius junction design with elbows provides smooth flow path
- Male nut threads are molybdenum disulfide-based lubricant to minimize the friction
- Hardened threads and smoothed surface finishes extend fitting life and prevent sticking of the matching threads

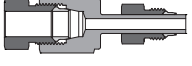
Configuration	Fitting Type	Example
	Male Connector	SS-CM-FH4-NS8
	Female Connector	SS-CF-FH6-NS4
	Union	SS-U-FH6
	Reducing Union	SS-U-FH8-FH6

Configuration	Fitting Type	Example
	Bulkhead Union	SS-BU-FH12
	Union Elbow	SS-LU-FH4
	Union Reducing Elbow	SS-LU-FH8-FH6
	Male Elbow	SS-LM-FH8-NS8
	Union Tee	SS-TTT-FH8
	Male Branch Tee	SS-TTM-FH12-NS12
	Union Cross	SS-C-FH4
	Cap	SS-TC-FH8
	Plug	SS-TP-FH6
	Nut	SS-N-FH2
	Ferrule	SS-FE-FH2
	Reducer	SS-R-FH6-FM8
	Port Connector	SS-P-FH8
	Adapter	SS-AM-FM8-NS4



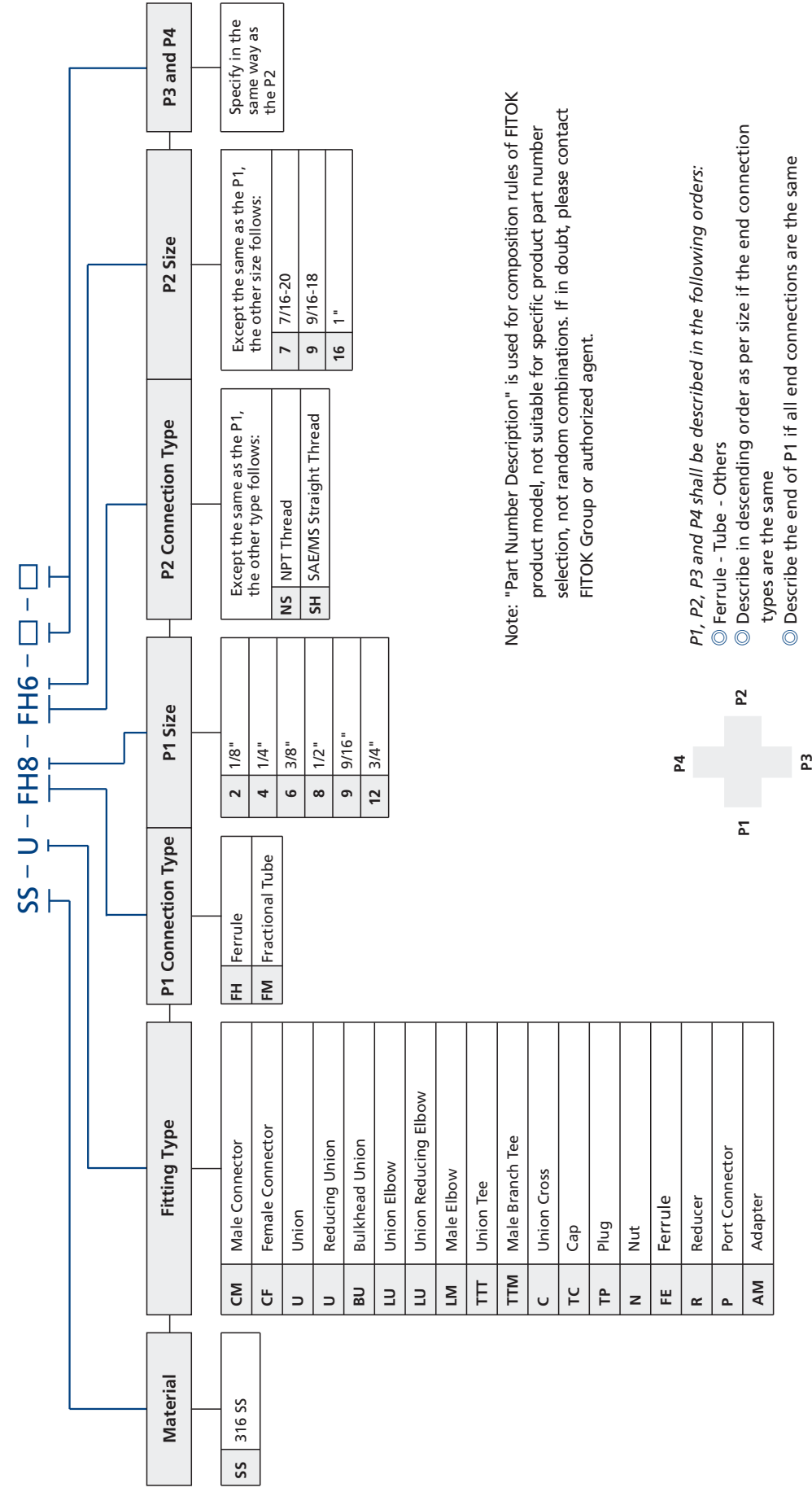





Part Number Description





20 Series Tube Fittings

- ⦿ Pressures up to 20000 psig (1379 bar)
- ⦿ Coned-and-Threaded Connection
- ⦿ Metal-to-metal seal provides perfect leak-tight service from critical vacuum to medium pressure
- ⦿ Anti-vibration connection components available
- ⦿ Fittings are easy to disconnect and retighten
- ⦿ Every fitting is stamped with size, material and heat code
- ⦿ Available to NACE MR-01-75

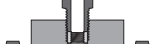
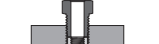

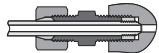







Configuration	Fitting Type	Example
	Gland	SS-G-2FH4
	Collar	SS-CO-2FH6
	Plug	SS-TP-2FH9
	Union Coupling	SS-U-2FH12
	Reducing Union Coupling	SS-U-2FH6-2FH4
	Union Coupling (Slip Type)	SS-SU-2FH16
	Bulkhead Coupling	SS-BU-2FH6
	Cap	SS-TC-2FH6
	Elbow	SS-LU-2FH9
	Tee	SS-TTT-2FH12
	Cross	SS-C-2FH4



Configuration	Fitting Type	Example
	Anti-Vibration Gland Assembly	SS-AVGA-2FH9
	Coned and Threaded Nipple	SS-CTN-2FH6-8

60 Series Tube Fittings

- ⦿ Pressures up to 60000 psig (4137 bar)
- ⦿ Coned-and-Threaded Connection
- ⦿ Metal-to-metal seal provides perfect leak-tight service from critical vacuum to high pressure
- ⦿ Anti-vibration connection components available
- ⦿ Fittings are easy to disconnect and retighten
- ⦿ Every fitting is stamped with size, material and heat code
- ⦿ Available to NACE MR-01-75

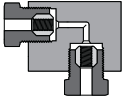
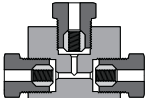
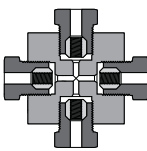
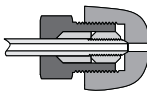

Configuration	Fitting Type	Example
	Gland	SS-G-6FH4
	Collar	SS-CO-6FH6
	Plug	SS-TP-6FH9
	Union Coupling	SS-U-6FH4
	Reducing Union Coupling	SS-U-6FH6-6FH4
	Union Coupling (Slip Type)	SS-SU-6FH6
	Bulkhead Coupling	SS-BU-6FH6
	Cap	SS-TC-6FH6

Configuration	Fitting Type	Example
	Elbow	SS-LU-6FH9
	Tee	SS-TTT-6FH6
	Cross	SS-C-6FH4
	Anti-Vibration Gland Assembly	SS-AVGA-6FH9
	Coned and Threaded Nipple	SS-CTN-6FH6-10

20 Series and 60 Series Tube Fittings Part Number Description

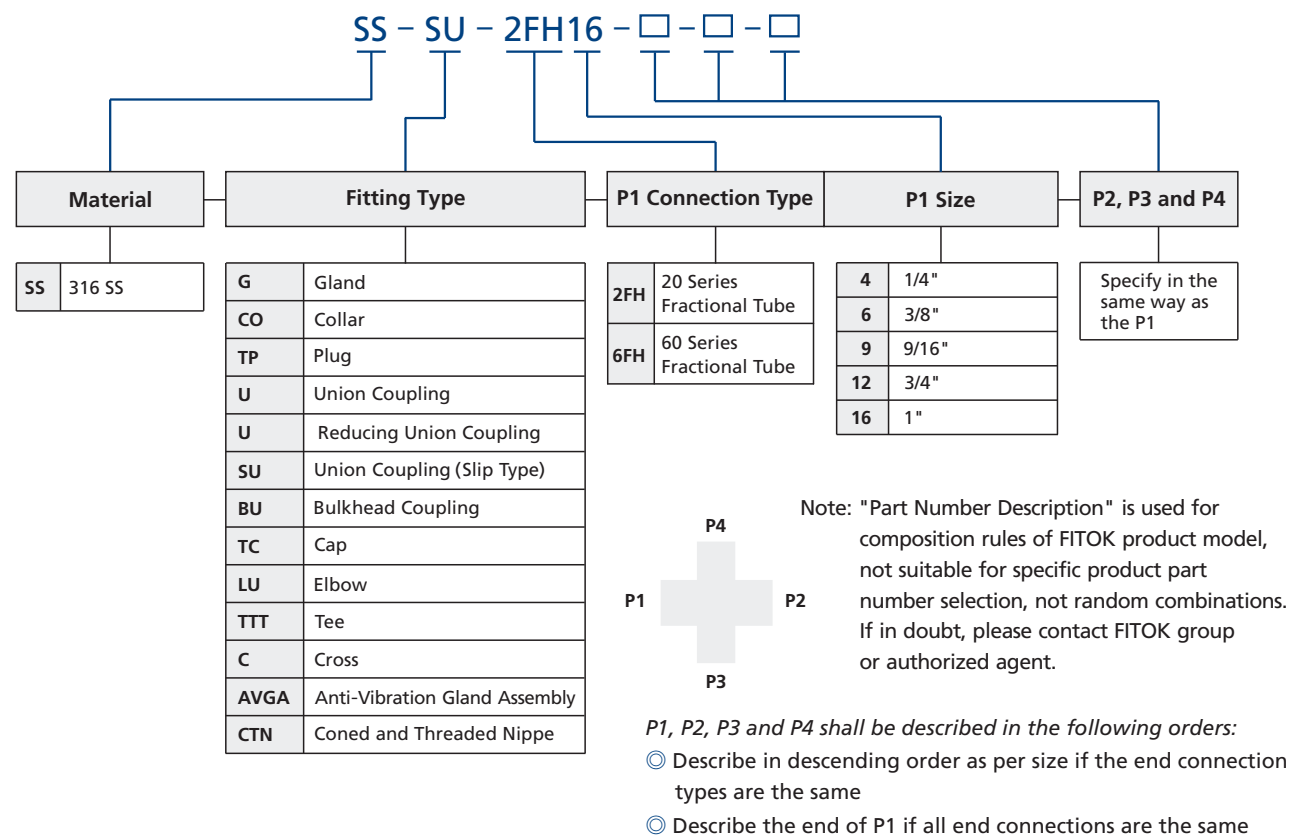

Pipe Fittings



- ⦿ The hardened threads with smooth surface avoid galling and help to extend the fitting service life
- ⦿ Radius junction design with elbows provides smooth flow path.
- ⦿ Every fitting is stamped with size, material, and heat code
- ⦿ 316 stainless steel standard material. Other materials are available upon request
- ⦿ Available to NACE MR-01-75

Configuration	Fitting Type	Example
	Pipe Plug	SS-HPP-NS4
	Hex Nipple	SS-HPHN-NS4
	Hex Long Nipple	SS-HPLN-NS4-50.8
	Pipe Cap	SS-HPC-NS4
	Hex Coupling	SS-HPCG-NS4

Configuration	Fitting Type	Example
	Zero-Clearance Union	SS-HPZC-NS4
	Adapter	SS-HPA-NS4
	Male Elbow	SS-HPME-NS4
	Street Elbow	SS-HPSE-NS4
	Female Elbow	SS-HPE-NS4
	Male Tee	SS-HPMT-NS4
	Male Street Tee	SS-HPST-NS4
	Male Branch Tee	SS-HPBT-NS4
	Female Tee	SS-HPT-NS4
	Female Cross	SS-HPCR-NS4

Part Number Description

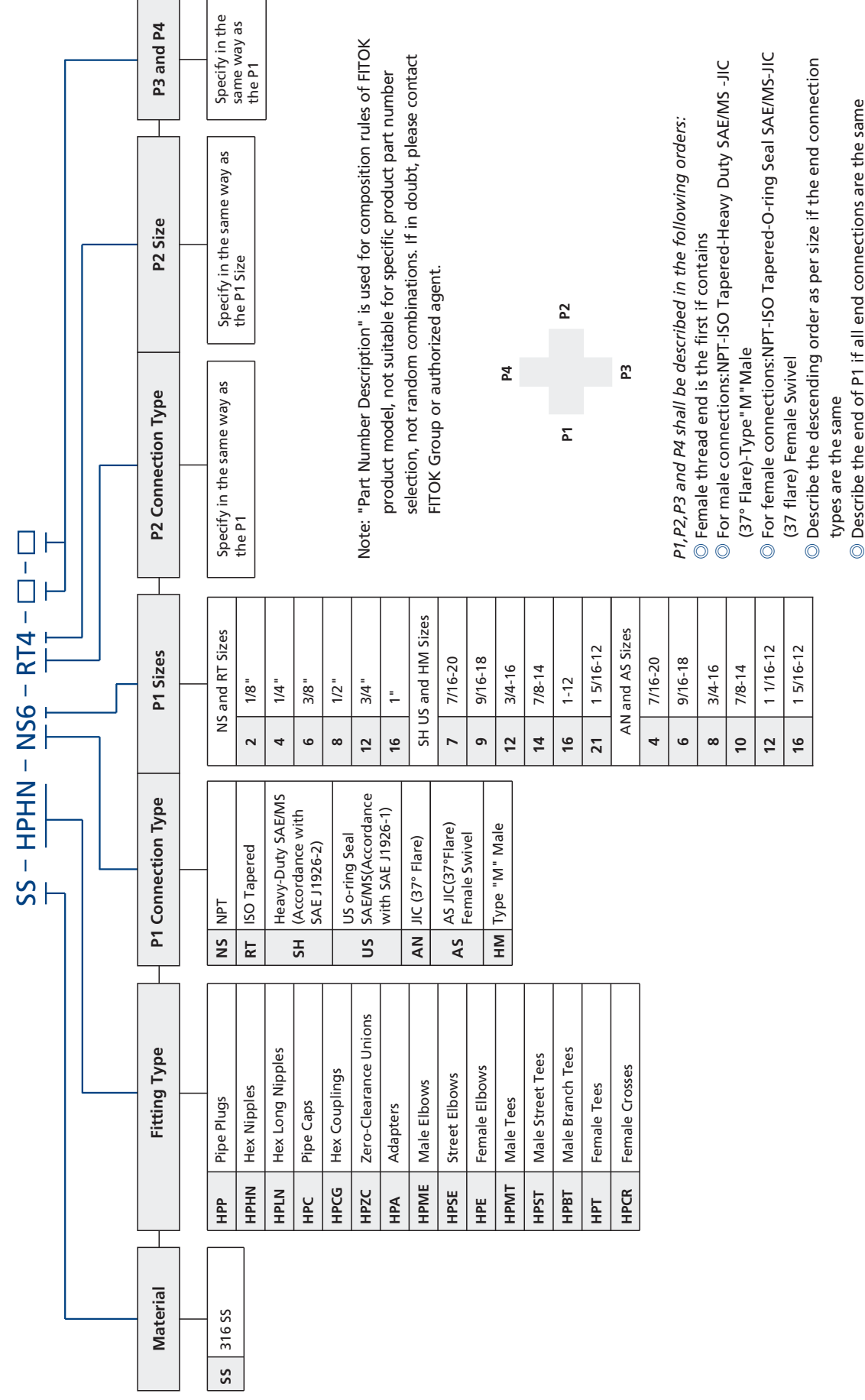

Adapters and Couplings









About "CP"



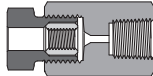
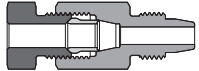
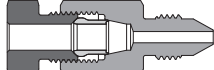
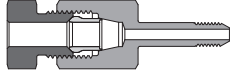
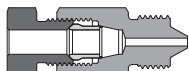
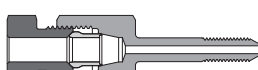

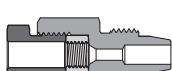
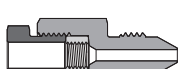
- ◎ The hardened threads with smooth surface finishing avoid galling and help to extend the fitting service life
- ◎ Every fitting is stamped with size, material, and heat code
- ◎ 316 stainless steel is standard material. Other materials are available upon request
- ◎ Available to NACE MR-01-75

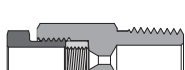
Ordering number with designator "□CP" is for "two-piece" male to male and female to male adapters. They are identical to the "one-piece" designs in length can be ordered by substituting "CP" for "MP" to the "one-piece" adapter part numbers listed.
 Example: Ordering number of "one-piece": SS-MMA-6MP6-6MP4
 The corresponding ordering number of "two-piece" is SS-MMA-6CP6-6CP4.

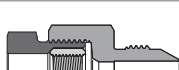
Configuration	Fitting Type	Example
	15 Series Male to 15 Series Male	SS-MMA-MP6-MP4
	15 Series Male to Male NPT Thread	SS-MMA-MP6-NS6
	15 Series Male to Male JIC	SS-MMA-MP4-AN6
	15 Series Male to Type "M" Male	SS-MMA-MP4-HM9
	20 Series Male to 15 Series Male	SS-MMA-2MP6-MP6
	20 Series Male to 20 Series Male	SS-MMA-2MP9-2MP6
	20 Series Male to Male NPT Thread	SS-MMA-2MP9-NS4

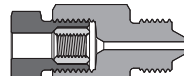
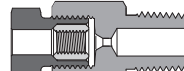
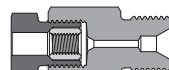
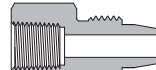
Configuration	Fitting Type	Example
	20 Series Male to Male JIC	SS-MMA-2MP9-AN6
	20 Series Male to Type "M" Male	SS-MMA-2MP6-HM9
	60 Series Male to 15 Series Male	SS-MMA-6MP6-MP4
	60 Series Male to 20 Series Male	SS-MMA-6MP6-2MP4
	60 Series Male to 60 Series Male	SS-MMA-6MP9-6MP4
	60 Series Male to Male NPT Thread	SS-MMA-6MP6-NS4
	60 Series Male to Male JIC	SS-MMA-6MP6-AN6
	60 Series Male to Type "M" Male	SS-MMA-6MP4-HM16
	Type "M" Male to 20 Series Coned and Threaded Nipples	SS-MMA-HM9-2CT6
	Type "M" Male to 60 Series Coned and Threaded Nipples	SS-MMA-HM9-6CT9
	20 Series Female to 15 Series Female	SS-FFC-2FH6-FH4
	20 Series Female to Female NPT Thread	SS-FFC-2FH6-NS4
	60 Series Female to 15 Series Female	SS-FFC-6FH4-FH8
	60 Series Female to 20 Series Female	SS-FFC-6FH6-2FH4

Configuration	Fitting Type	Example
	60 Series Female to Female NPT Thread	SS-FFC-6FH6-NS4
	15 Series Female to 15 Series Male	SS-FMA-FH4-MP6
	15 Series Female to 20 Series Male	SS-FMA-FH4-2MP4
	15 Series Female to 20 Series Coned and Threaded Nipples	SS-FMA-FH6-2CT4
	15 Series Female to 60 Series Male	SS-FMA-FH6-6MP4
	15 Series Female to 60 Series Coned and Threaded Nipples	SS-FMA-FH4-6CT9
	15 Series Female to Type "M" Male	SS-FMA-FH6-HM9
	20 Series Female to 15 Series Male	SS-FMA-2FH9-MP6
	20 Series Female to 20 Series Male	SS-FMA-2FH6-2MP9
	20 Series Female to 60 Series Male	SS-FMA-2FH9-6MP4
	20 Series Female to Male NPT Thread	SS-FMA-2FH9-NS4
	20 Series Female to Type "M" Male	SS-FMA-2FH9-HM9
	60 Series Female to 15 Series Male	SS-FMA-6FH6-MP4
	60 Series Female to 20 Series Male	SS-FMA-6FH9-2MP4

Configuration	Fitting Type	Example
	60 Series Female to 60 Series Male	SS-FMA-6FH6-6MP6
	60 Series Female to Male NPT Thread	SS-FMA-6FH6-NS4
	60 Series Female to Type "M" Male	SS-FMA-6FH6-HM9
	Female NPT Thread to 15 Series Male	SS-FMA-NS4-MP6
	Female NPT Thread to 20 Series Male	SS-FMA-NS6-2MP4
	Female NPT Thread to 20 Series Coned and Threaded Nipples	SS-FMA-NS4-2CT6
	Female NPT Thread to 60 Series Male	SS-FMA-NS6-6MP4
	Female NPT Thread to 60 Series Coned and Threaded Nipples	SS-FMA-NS6-6CT6

Part Number Description

SS - MMA - 2MP6 - NS4

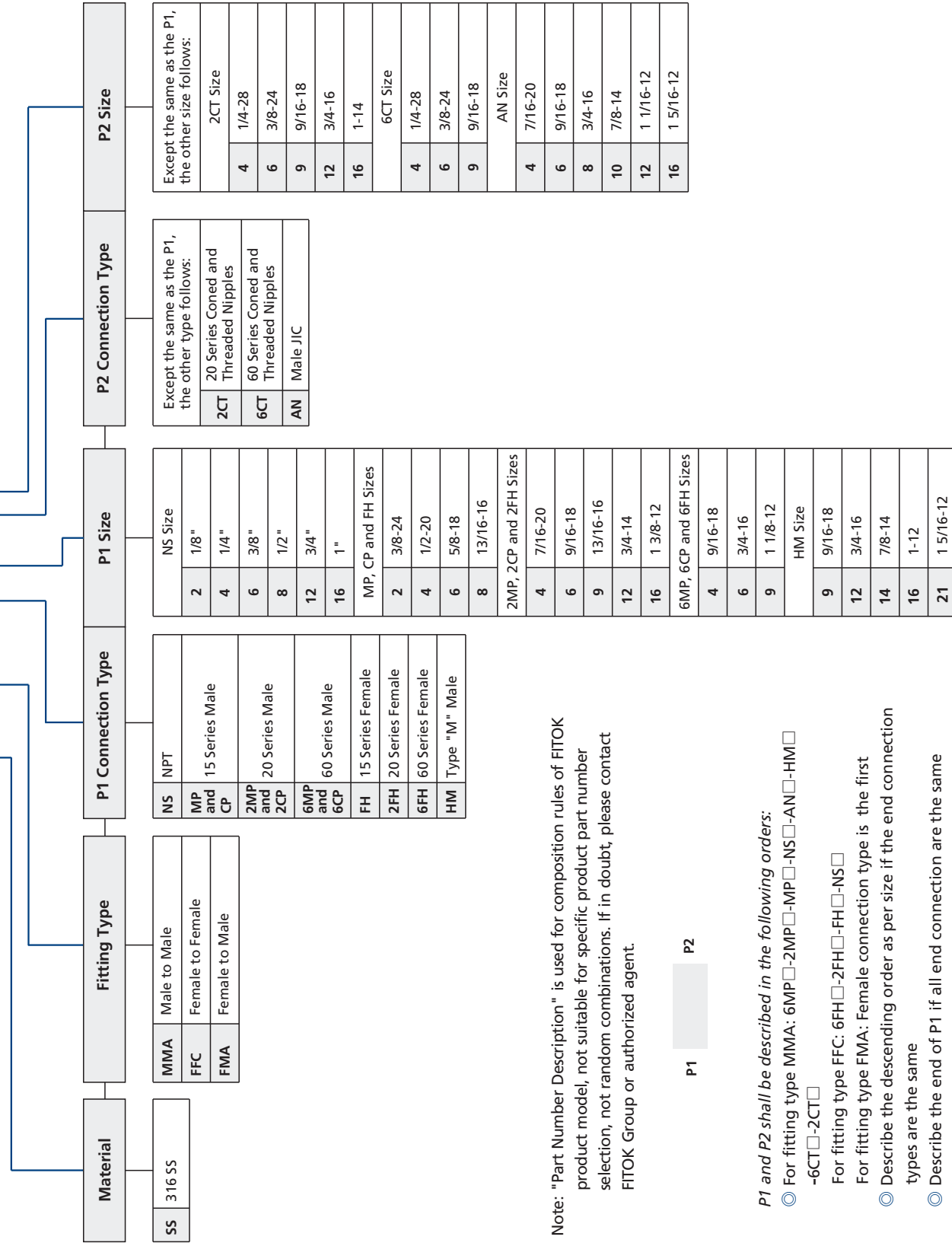

Note: "Part Number Description" is used for composition rules of FITOK product model, not suitable for specific product part number selection, not random combinations. If in doubt, please contact FITOK Group or authorized agent.

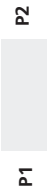

- P1 and P2 shall be described in the following orders:
- For fitting type MMA: 6MP-2MP-CP-NS-AN-HM-6CT-2CT
 - For fitting type FFC: 6FH-2FH-FH-NS
 - For fitting type FMA: Female connection type is the first
 - Describe the descending order as per size if the end connection types are the same
 - Describe the end of P1 if all end connection are the same

Medium & High Pressure Valves

Needle Valves



- Non-rotating stem and bar stock body design
- Easy to assemble and replace packing
- Metal-to-metal seating achieves ideal shutoff, longer stem/seat service lifetime for abrasive flow, excellent corrosion resistance and greater durability for repeated on/off cycles
- The standard packing material for 60N Series is Nylon, the other Series is PTFE. RPTFE glass, Graphite and extend stuffing box with Graphite are also available
- Extended stuffing box with of Graphite can be operated to 1200°F (649°C)
- The location of packing is under the thread of upper stem.
- The material of packing gland and lower stem have been selected to achieve reduced handle torque and extended thread cycle life
- Options for Vee or Regulating stem tips
- Five flow patterns are available
- Available to NACE MR-01-75

10N Series Needle Valves

- End connections: 9/16", 3/4", 1" tube fittings and 3/4 NPT, 3/4 BSPT, 1 NPT, 1 BSPT
- Body material: 316 SS
- Orifice sizes: 0.359", 0.516", 0.688", 0.438" and 0.562"
- Working pressure up to: 10000 psig (690 bar)
- Working temperature: -100°F to 1200°F (-73°C to 649°C)

15N Series Needle Valves

- End connections: 1/8", 1/4", 3/8", 1/2" tube fittings and 1/8 NPT, 1/8 BSPT, 1/4 NPT, 1/4 BSPT, 3/8 NPT, 3/8 BSPT, 1/2 NPT, 1/2 BSPT
- Body material: 316 SS
- Orifice sizes: 0.094", 0.188", 0.250", 0.375", 0.078", 0.203", 0.219" and 0.312"
- Working pressure up to: 15000 psig (1034 bar)
- Working temperature: -100°F to 800°F (-73°C to 427°C)

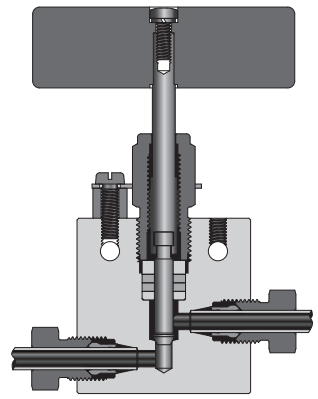
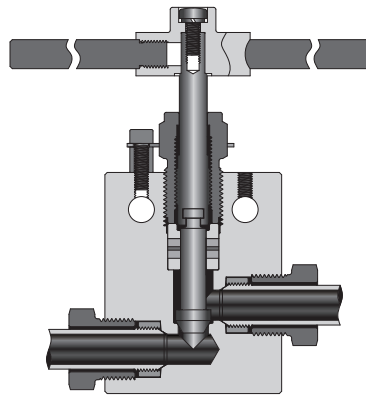

20N Series Needle Valves

- End connections: 1/4", 3/8", 9/16", 3/4" and 1" tube fittings
- Body material: 316 SS
- Orifice sizes: 0.125", 0.219", 0.312", 0.438" and 0.562"
- Working pressure up to: 20000 psig (1379 bar)
- Working temperature: -100°F to 1200°F (-73°C to 649°C)

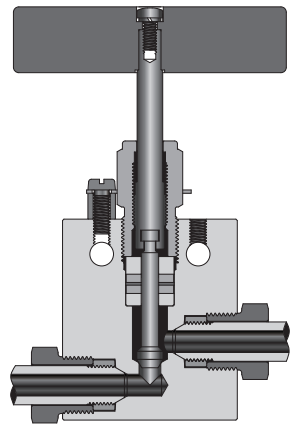

30N Series Needle Valves

- End connections: 1/4", 3/8" and 9/16" tube fittings
- Body material: 316 SS
- Orifice sizes: 0.094" and 0.125"
- Working pressure up to: 30000 psig (2068 bar)
- Working temperature: -100°F to 1200°F (-73°C to 649°C)

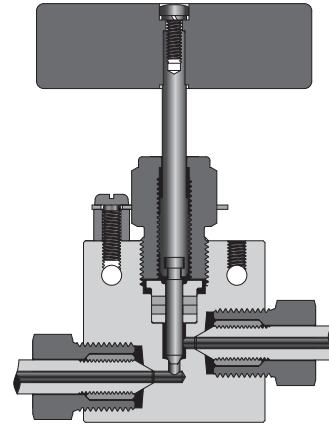

60N Series Needle Valves

- End connections: 1/4", 3/8", 9/16" tube fittings
- Body material: 316 SS
- Orifice sizes: 0.063" and 0.078"
- Working pressure up to: 60000 psig (4137 bar)
- Working temperature: -100°F to 1200°F (-73°C to 649°C)

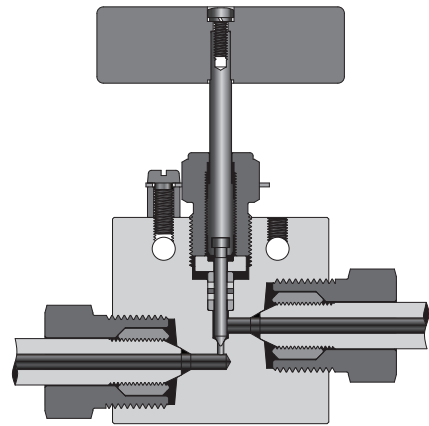

Part Number Description

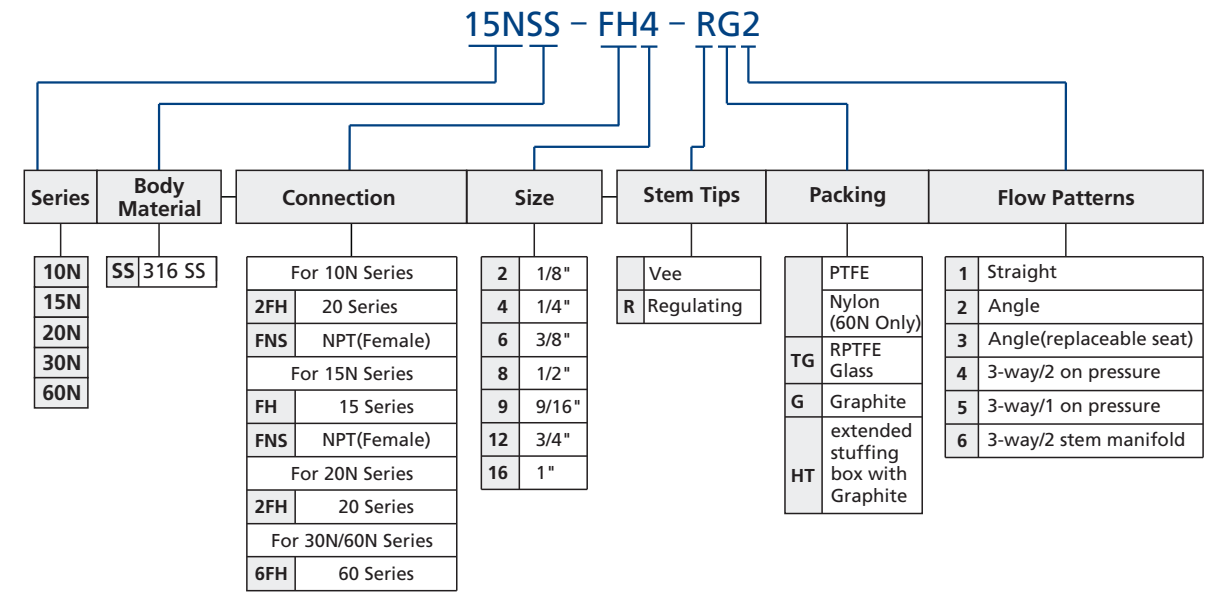

Note: "Part Number Description" is used for composition rules of FITOK product model, not suitable for specific product part number selection, not random combinations. If in doubt, please contact FITOK Group or authorized agent.

Ball Valves



- One-piece, trunnion mounted style, ideal for severe duty applications
- Two-way and three-way valve configurations
- PEEK seats offer excellent resistance to chemicals, heat, and wear/abrasion
- Full-port flow path minimizes pressure drop
- Optional O-rings available for high-temperature applications
- Pneumatic actuator options

10B Series Ball Valves

- End connections: 3/4" and 1" tube fittings, 3/4 and 1 NPT threads
- Body material: 316 SS
- Orifice sizes: 2-way: 0.5", 3-way: 0.5"
- Working pressure up to: 10000 psig (690 bar)
- Fluorocarbon FKM O-ring working temperature: 0°F to 400°F (-17.8°C to 204°C)

20B Series Ball Valves

- End connections: 1/4", 3/8", 9/16" and 3/4" tube fittings
- Body material: 316 SS
- Orifice sizes: 2-way: 0.094" to 0.375", 3-way: 0.094" to 0.19"
- Working pressure up to: 20000 psig (1379 bar)
- Fluorocarbon FKM O-ring working temperature: 0°F to 400°F (-17.8°C to 204°C)

15B Series Ball Valves

- End connections: 1/8", 1/4", 3/8", 1/2", 9/16" and 3/4" tube fittings, 1/8, 1/4, 3/8 and 1/2 NPT threads
- Body material: 316 SS
- Orifice sizes: 2-way: 0.094" to 0.375", 3-way: 0.094" to 0.328"
- Working pressure up to: 15000 psig (1034 bar)
- Fluorocarbon FKM O-ring working temperature: 0°F to 400°F (-17.8°C to 204°C)

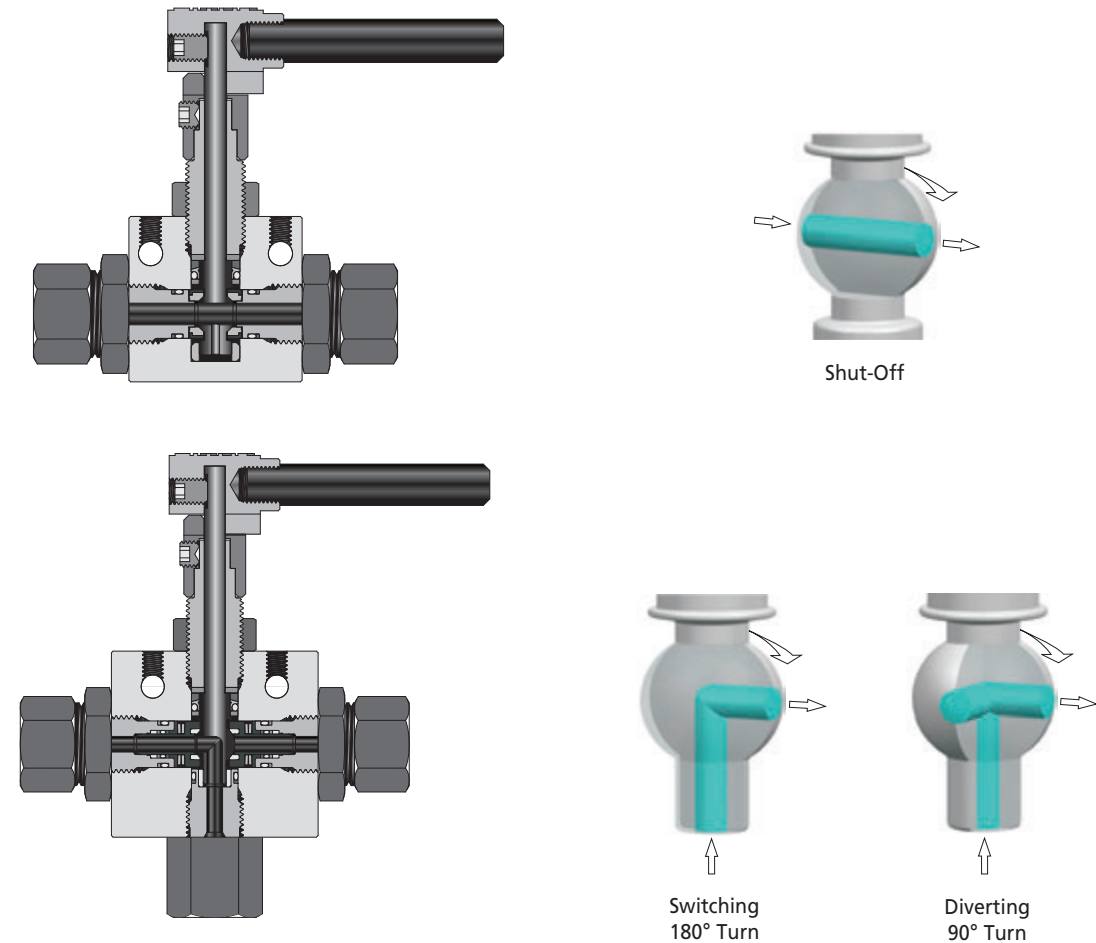

Part Number Description

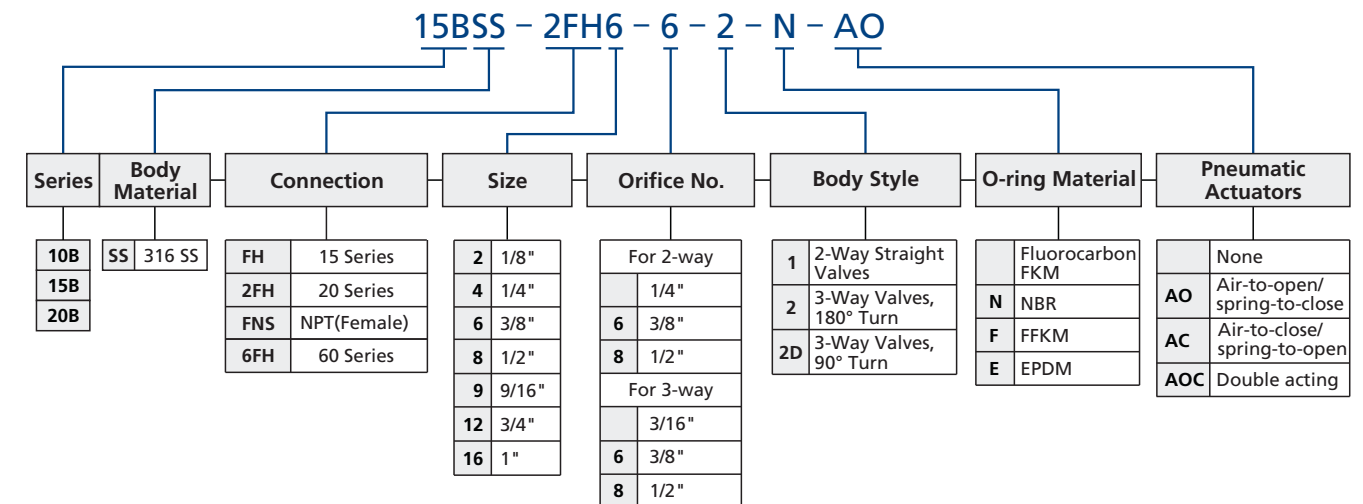

Note: 1. Operators 90° rotations standard. 180° options available upon request.
 2. "Part Number Description" is used for composition rules of FITOK product model, not suitable for specific product part number selection, not random combinations. If in doubt, please contact FITOK Group or authorized agent.

Code	O-ring Material	Temperature Range
	Fluorocarbon FKM	0 to 400°F (-17.8 to 204°C)
N	NBR	-40 to 250°F (-40 to 121°C)
F	FFKM	-20 to 500°F (-29 to 260°C)
E	EPDM	-50 to 300°F (-45 to 148°C)

Check Valves



- Provides unidirectional flow and tight shut-off for liquid and gases with high reliability. When differential drops below cracking pressure, valve shuts off (Not for use as relief valve)
- Body material: 316 SS
- Resilient O-ring seat design for noise-free closing leakage-free
- Optional O-rings available for high-temperature applications
- Cracking pressure:
 - 10C, 15C, 20C and 60C Series Check Valves: 14 psig~26 psig (0.966 bar~1.794 bar)
- Available to NACE MR-01-75

10C, 10CO Series Check Valves

- End connections: 3/4 NPT and 1 NPT
- Orifice sizes: 0.52" and 0.69"
- Working pressure up to: 10000 psig (690 bar)
- Working temperature:
 - 10C Series (Pipe O-ring Check Valves): -50°F to 400°F (-45°C to 204°C)
 - 10CO Series (Ball Check Valves): -110°F to 400°F (-79°C to 204°C)

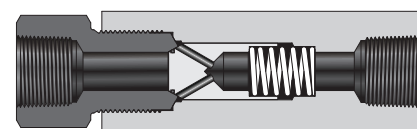

10C Series (Pipe O-ring Check Valves)

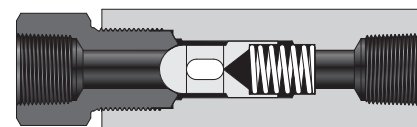

10CO Series (Pipe Ball Check Valves)

15C, 15CO Series Check Valves

- End connections:
 - O-ring Check Valves and Ball Check Valves: 1/4", 3/8" and 1/2" tube fittings
 - Pipe O-ring Check Valves and Pipe Ball Check Valves: 1/4 NPT, 3/8 NPT and 1/2 NPT
- Orifice sizes:
 - O-ring Check Valves and Ball Check Valves: 0.188", 0.25" and 0.375"
 - Pipe O-ring Check Valves and Pipe Ball Check Valves: 0.12", 0.22" and 0.36"
- Working pressure up to: 15000 psig (1034 bar)
- Working temperature:
 - 15C Series (O-ring Check Valves): -50°F to 550°F (-45°C to 288°C)
 - 15C Series (Pipe O-ring Check Valves): -50°F to 400°F (-45°C to 204°C)
 - 15CO Series (Ball Check Valves): -110°F to 800°F (-79°C to 427°C)
 - 15CO Series (Pipe Ball Check Valves): -110°F to 400°F (-79°C to 204°C)

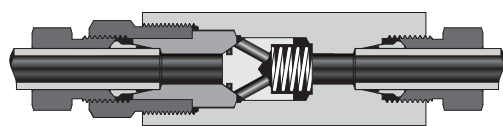

15C Series (O-ring Check Valves)

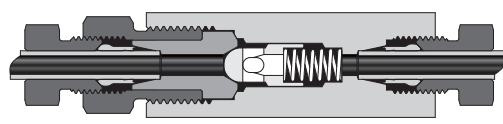

15CO Series (Ball Check Valves)

20C, 20CO Series Check Valves

- End connections: 1/4", 3/8", 9/16", 3/4" and 1" tube fittings
- Orifice sizes: 0.125", 0.218", 0.359", 0.516" and 0.688"
- Working pressure up to: 20000 psig (1379 bar)
- Working temperature:
 - 20C Series Check Valves (O-ring Check Valves): -50°F to 550°F (-45°C to 288°C)
 - 20CO Series Check Valves (Ball Check Valves): -110°F to 1200°F (-79°C to 649°C)

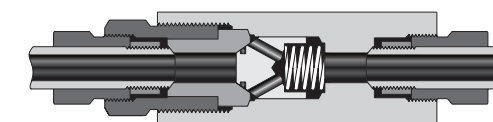

20C Series (O-ring Check Valves)

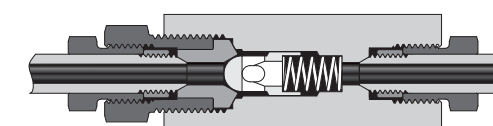

20CO Series (Ball Check Valves)

60C, 60CO Series Check Valves

- End connections: 1/4", 3/8" and 9/16" tube fittings
- Orifice sizes: 0.094", 0.125" and 0.187"
- Working pressure up to: 60000 psig (4137 bar)
- Working temperature:
 - 60C Series Check Valves (O-ring Check Valves): -50°F to 550°F (-45°C to 288°C)
 - 60CO Series Check Valves (Ball Check Valves): -110°F to 1200°F (-79°C to 649°C)

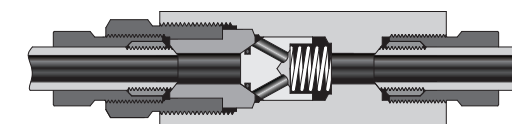

60C Series (O-ring Check Valves)

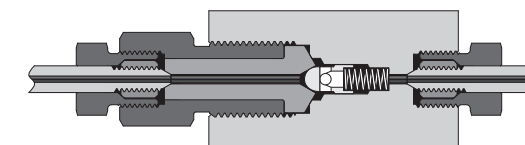

60CO Series (Ball Check Valves)

Part Number Description

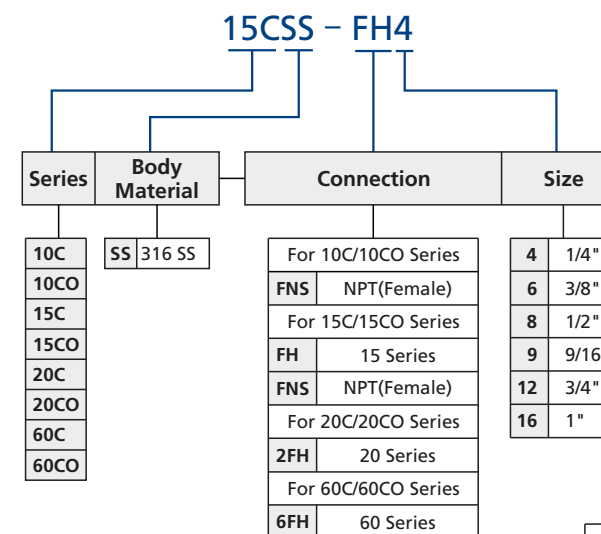

Code	O-ring Material	Temperature Range
	Fluorocarbon FKM	0 to 400°F (-17.8 to 204°C)
N	NBR	-40 to 250°F (-40 to 121°C)
F	FFKM	-20 to 550°F (-29 to 288°C)
E	EPDM	-50 to 300°F (-45 to 148°C)

Note: "Part Number Description" is used for composition rules of FITOK product model, not suitable for specific product part number selection, not random combinations. If in doubt, please contact FITOK Group or authorized agent.

Options: O-ring
Fluorocarbon FKM is standard. For other materials, add a material code to the valve ordering number. Example: 20CSS-2FH6-K

Metering Valves

- The design of Barrel and Thimble micrometer permits repeatable settings
Each division of barrel equal to 0.025"
Thimble is divided into 25 divisions, each division of thimble equal to 0.001" stem travel
One revolution equal to valve stem 0.025" travel
- Precise Metering valves are not intended for use as shut-off valves
- The minimum flow rate is factory set at "0" position. The valve will be damaged when the valve operated below "0" position. When shutoff is required, a correlated shutoff valve from 15B, 20B, 15N, 20N, 30N and 60N series valve should be installed series with the Precise Metering Valves
- The location of packing is under the thread of valve stem
- Reliable locking device of packing gland design
- Extend stuffing box valve with of Graphite can be operated to 1200°F (649°C)



- End connections:
15M series: 1/8" and 1/4" tube fitting
30M series: 1/4" tube fitting
60M series: 1/4" and 3/8" tube fittings
- Body material: 316 SS
- Orifice sizes: 0.062"
- Flow coefficient (Cv): 0.04
- Working pressure up to:
15M series: 15000 psig (1034 bar)
30M series: 30000 psig (2068 bar)
60M series: 60000 psig (4137 bar)
- Working temperature: -100°F to 1200°F (-73°C to 649°C)

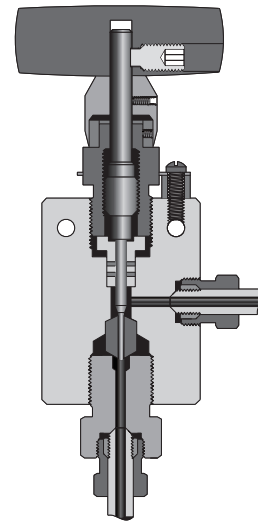

Part Number Description

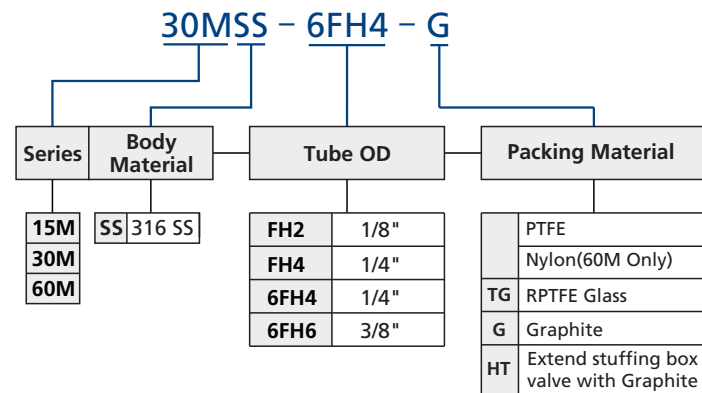

Note: "Part Number Description" is used for composition rules of FITOK product model, not suitable for specific product part number selection, not random combinations. If in doubt, please contact FITOK Group or authorized agent.

Relief Valves

- Maximum back pressure: 500 psig (34.5 bar)
- Liquid or gas service
- Pressure settings of HSR Series and HMR Series valves are made at the factory and valves are tagged accordingly.
State the required set pressure with the order please
- Pressure settings of HAR Series valves are adjusted on use's own
- Lock wired secure cap to maintain set pressure
- Easily exchangeable replaceable seat
- Free assembly positions



HSR Series Relief Valves

- Inlet connection:
9/16" of 20 series tube fittings
- Outlet connection: 3/4 NPT thread
- Body material: 316 SS
- Orifice sizes: 0.156" to 0.312"
- Soft seat relief valves
- Set pressure: 1500 to 20000 psig (103.4 to 1378.9 bar)
- Working temperature:
32°F to 400°F (0°C to 204°C)

HMR Series Relief Valves

- Inlet connection:
9/16" of 20 series tube fittings
3/8" of 60 series tube fittings
- Outlet connection: 3/4 NPT thread
- Body material: 316 SS
- Orifice sizes: 0.078" to 0.312"
- Metal seat relief valves
- Set pressure: 3000 to 60000 psig (206.8 to 4136.8 bar)
- Working temperature:
-110°F to 500°F (-79°C to 260°C)

HAR Series Relief Valves

- Inlet connection:
9/16" of 20 series tube fittings
- Outlet connection: 3/4 NPT thread
- Body material: 316 SS
- Orifice sizes: 0.093" to 0.197"
- Field adjustable and soft seat relief valves
- Set pressure: 3000 to 20000 psig (206.8 to 1378.9 bar)
- Working temperature:
32°F to 400°F (0°C to 204°C)

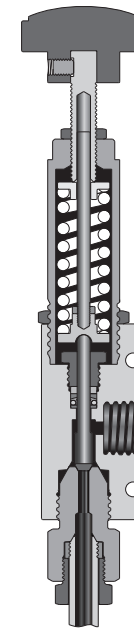
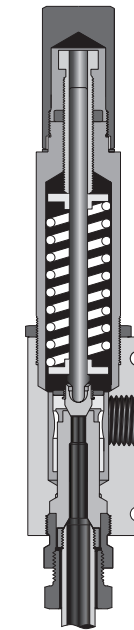
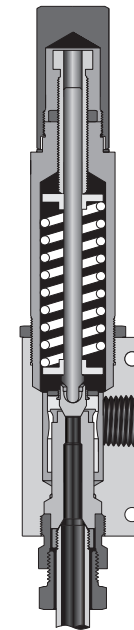

Part Number Description

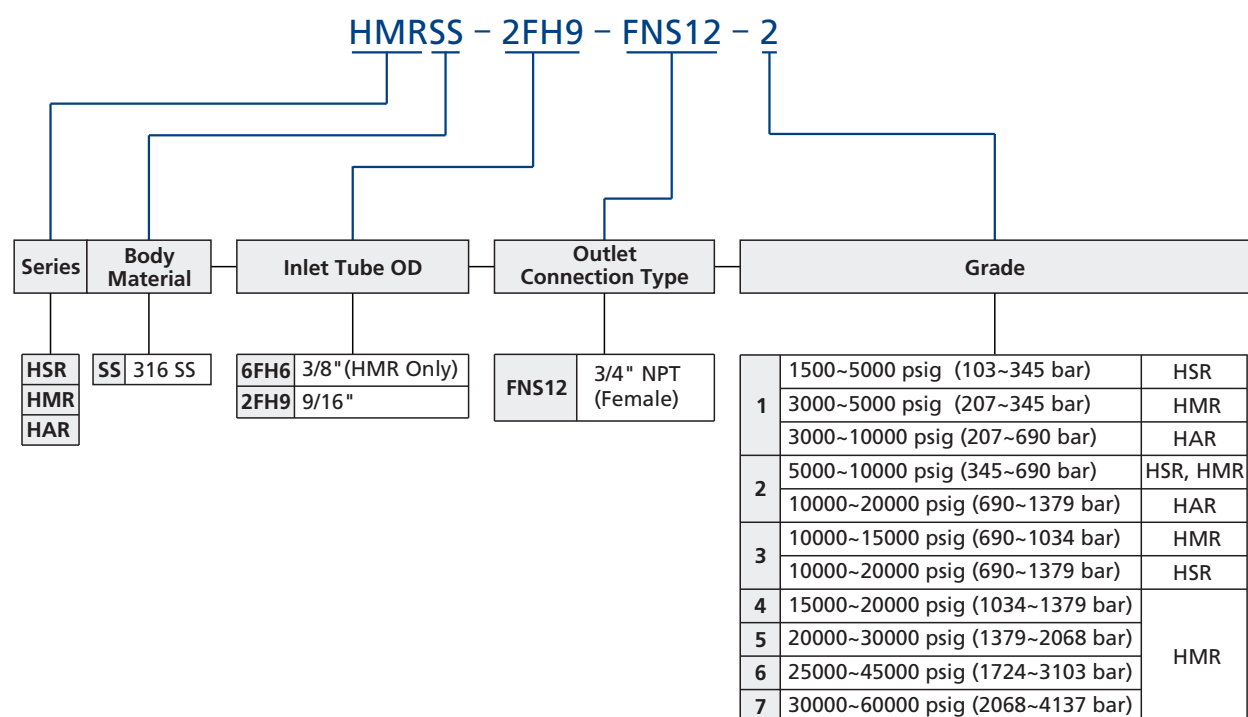

Note: 1. Pressure settings are made at the factory and valves are tagged accordingly. State the required set pressure with the order please.
2. "Part Number Description" is used for composition rules of FITOK product model, not suitable for specific product part number selection, not random combinations. If in doubt, please contact FITOK Group or authorized agent.

Line Filters



Dual-disc Line Filters

- Dual-disc Line Filters are utilized in chemical processing, aerospace, nuclear and other applications
- The large contaminations particles are filtrated by upstream element. The rest of contaminations particles are filtrate by downstream element
- Easy to replace filter element
- Standard size of downstream/upstream nominal pore is 5/10, 10/35 and 35/65 μm . Other element combinations also available on special order
- Pressure differential not to exceed 1,000 psig (69 bar) in a flowing condition

Cup-type Line Filters

- The filter elements can be quickly and easily replaced
- Cup-type Line Filters are recommended in high pressure systems requiring both maximum filter surface area and high flow rates. Cup-type Line Filters are widely used in chemical processing and industrial fields. The cup design of this filter offers about six times the effective filter area as compared to disc-type units
- Nominal pore sizes for filter element: 5, 35 and 65 μm
- Pressure differential not to exceed 1,000 psig (69 bar) in a flowing condition

10FD, 10FC Series Line Filters

- End connections: 3/4 NPT and 1 NPT
- Body material: 316 SS
- Orifice sizes:
10FD Series: 0.359" and 0.563"
10FC Series: 0.516" and 0.688"
- Working pressure up to: 10000 psig (690 bar)
- Working temperature: -60°F to 400°F (-50°C to 204°C)

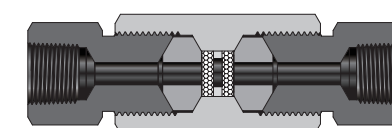

10FD Series (Dual-disc)

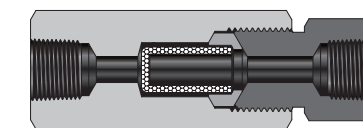

10FC Series (Cup-type)

15FD, 15FC Series Line Filters

- End connections: 1/8", 1/4", 3/8", 1/2" tube fittings and 1/8 NPT, 1/4 NPT, 3/8 NPT, 1/2 NPT
- Body material: 316 SS
- Orifice sizes:
15FD Series: 0.094", 0.125", 0.188" and 0.312"
15FC Series: 0.125", 0.188", 0.312" and 0.438"
- Working pressure up to: 15000 psig (1034 bar)
- Working temperature:
Tube fittings: -60°F to 660°F (-50°C to 350°C)
NPT thread ends: -60°F to 400°F (-50°C to 204°C)

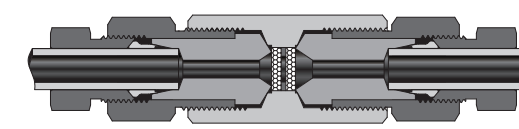

15FD Series (Dual-disc)

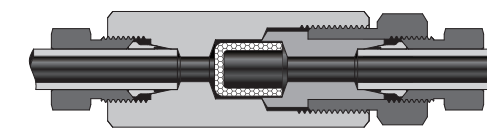

15FC Series (Cup-type)

20FD, 20FC Series Line Filters

- End connections:
 - 20FD Series: 9/16" tube fitting
 - 20FC Series: 1/4", 3/8", 9/16", 3/4" and 1" tube fittings
- Body material: 316 SS
- Orifice sizes:
 - 20FD Series: 0.312"
 - 20FC Series: 0.125", 0.218", 0.359", 0.516" and 0.688"
- Working pressure up to: 20000 psig (1379 bar)
- Working temperature: -60°F to 660°F (-50°C to 350°C)

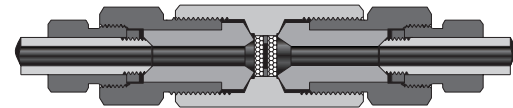

20FD Series (Dual-disc)

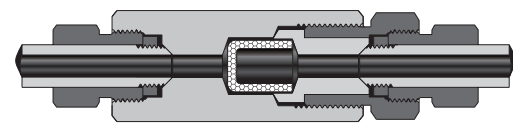

20FC Series (Cup-type)

60FD, 60FC Series Line Filters

- End connections: 1/4", 3/8" and 9/16" tube fittings
- Body material: 316 SS
- Orifice sizes:
 - 60FD Series: 0.094", 0.125" and 0.187"
 - 60FC Series: 0.094", 0.125" and 0.187"
- Working pressure up to: 60000 psig (4137 bar)
- Working temperature: -60°F to 660°F (-50°C to 350°C)

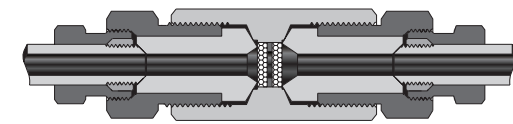

60FD Series (Dual-disc)

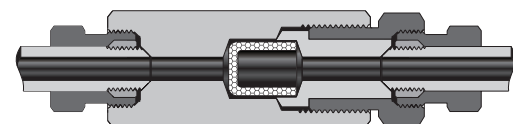

60FC Series (Cup-type)

Part Number Description

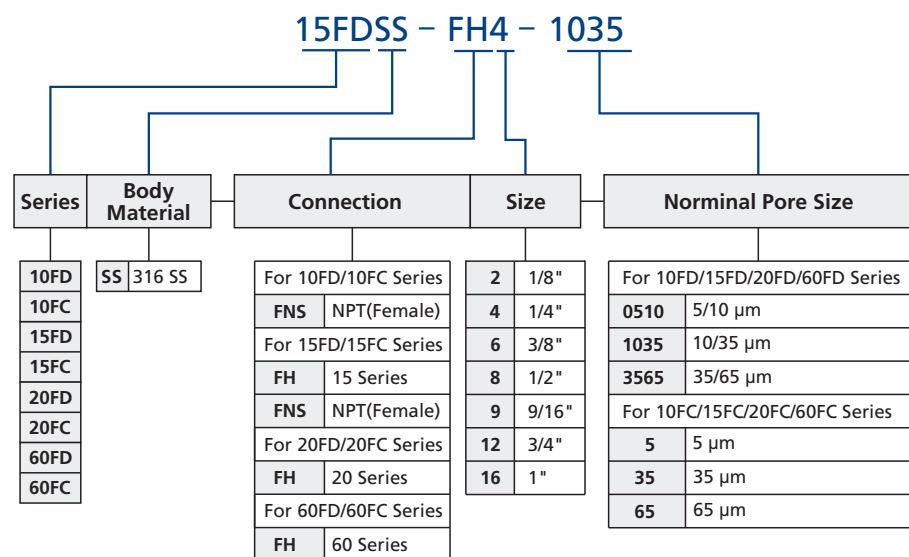

Note: "Part Number Description" is used for composition rules of FITOK product model, not suitable for specific product part number selection, not random combinations. If in doubt, please contact FITOK Group or authorized agent.

Medium & High Pressure Tubings



15 Series Tubing

- Working pressures up to 15 000 psig (1034 bar)
- 316/316L and 304/304L stainless steel are standard materials. Other materials are available upon request
- Example:
 - 316 SS: SS-15T4-083-6M
 - 304 SS: S4-15T8-156-5

20 Series Tubing

- Working pressures up to 20000 psig (1379 bar)
- 316/316L and 304/304L stainless steel are standard materials. Other materials are available upon request
- Example:
 - 316 SS: SS-MT-2FH6-10
 - 304 SS: S4-MT-2FH9-3M

60 Series Tubing

- Working pressures up to 60000 psig (4137 bar)
- 316/316L and 304/304L stainless steel are standard materials. Other materials are available upon request
- Example:
 - 316 SS: SS-HT-6FH4-5
 - 304 SS: S4-HT-6FH9-3M

Tools

Coning Tools

⦿ For preparing a "cone" on the 20 and 60 series tubing ends.

Tube O.D. x I.D. in.	Ordering Number
1/4 x 0.109	HCT-M4
3/8 x 0.203	HCT-M6
9/16 x 0.312	HCT-M9
1/4 x 0.083	HCT-H4
3/8 x 0.125	HCT-H6
9/16 x 0.188	HCT-H9



Threading Tools

⦿ For preparing a left hand thread on the 20 and 60 series tubing ends.

Tube O.D. in.	Ordering Number	Thread Size (Left Hand)
1/4	HTT-4	1/4-28 UNF
3/8	HTT-6	3/8-24 UNF
9/16	HTT-9	9/16-18 UNF



Reseating Tools

⦿ For repairing the damaged tube connector seats in 20 and 60 series tube fittings and valves.

Connection Size in.	Connection Type	Ordering Number
1/4	2FH4	HRT-M4
3/8	2FH6	HRT-M6
9/16	2FH9	HRT-M9
3/4	2FH12	HRT-M12
1	2FH16	HRT-M16
1/4	6FH4	HRT-H4
3/8	6FH6	HRT-H6
9/16	6FH9	HRT-H9



Manual Presetting Tool

Ordering Number	Tube O.D. in.
PST-2	1/8
PST-4	1/4
PST-6	3/8
PST-8	1/2



High Pressure Hydraulic Presetting Tools

Ordering Number	Tube O.D. in.
HPT-HF	1/2, 9/16, 3/4
HPT-H+U	Choose your needs from Die Heads. ex:HPT-H+HPT-H-FH8.



Die Heads

Ordering Number	Tube O.D. in.
HPT-H-FH8	1/2
HPT-H-FH9	9/16
HPT-H-FH12	3/4

Fittings

Butt Weld Fittings

M Series

- Sizes range from 1/8" to 1/2" and 6 mm to 12 mm
- 316, 316L, 316L VAR and 316L VIM/VAR stainless steel materials are available
- Butt weld connection allows for a smooth transition
- Radius junction design with elbows provides smooth flow path.
- Maximum working temperature is 850°F (454°C)
- Standard wetted surface finish is average 10 μin. (0.25 μm) Ra
- Every fitting is stamped with size, material, and heat code



Configuration	Fitting Type	Example
	Reducing Union	6LV-WU1-TB8-TB4
	90° Union Elbow	6LW-WL1-MTB10
	Reducing Union Elbow	6LW-WL1-MTB12-MTB6
	45° Union Elbow	6LW-WV1-TB4
	Tribow	6LW-WB1-TB4
	Union Tee	6LW-WT1-MTB12
	Reducing Tee	6LW-WT1-TB8-TB8-TB4
	Union Cross	6LW-WC1-TB6

L Series

- Sizes range from 1/4" to 1" and 6 mm to 18 mm
- 316L stainless steel materials are standard
- Butt weld connection allows for a smooth transition
- Radius junction design with elbows provides smooth flow path
- Maximum working temperature is 850°F (454°C)
- Standard wetted surface finish is average 10 μin. (0.25 μm) Ra
- Every fitting is stamped with size, material, and heat code



Configuration	Fitting Type	Example
	Reducing Union	6L-WU2-TB8-TB4
	Union Elbow	6L-WL2-MTB10
	Union Tee	6L-WT2-MTB10
	Reducing Tee	6L-WT2-TB8-TB8-TB4
	Union Cross	6L-WC2-TB8

M and L Series Butt Weld Fitting Part Number Description

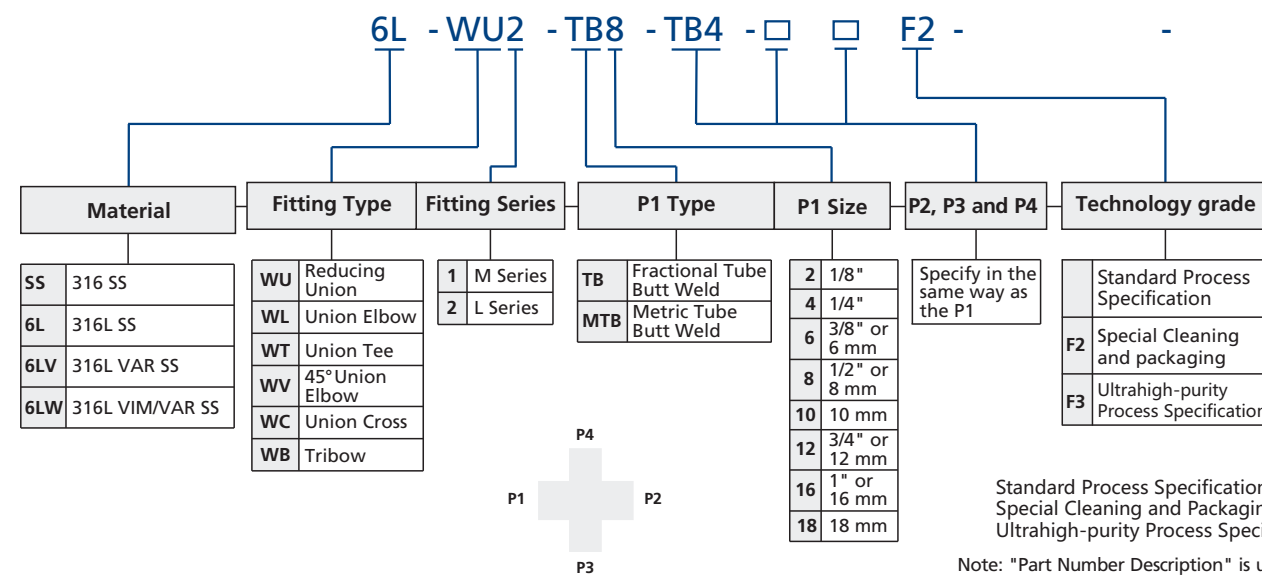

P1, P2, P3 and P4 shall be described in the following orders:
 ○ Describe in descending order as per size if the end connection types are the same
 ○ Describe the end of P1 if all end connections are the same

Standard Process Specification
 Special Cleaning and Packaging
 Ultrahigh-purity Process Specification
 Note: "Part Number Description" is used for composition rules of FITOK product model, not suitable for specific product part number selection, not random combinations. In if in doubt, please contact FITOK Group or authorized agent.

Metal Gasket Face Seal Fittings



FR Series

- Sizes range from 1/16" to 1" and 6 mm to 18 mm
- 316, 316L, and 316L VAR stainless steel materials are available
- Metal-to-metal seal provides perfect leak-tight service from vacuum to high pressure
- Standard wetted surface finish is average 10 µin. (0.25 µm) Ra
- Glands and bodies are stamped with size, material, and heat code
- All seal faces and male threads are protected with plastic caps
- FR female threads are silver plated

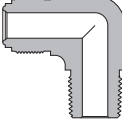
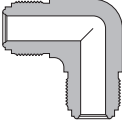
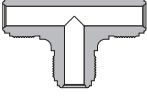
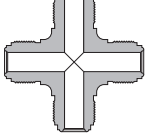
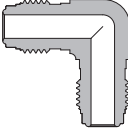
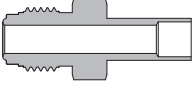
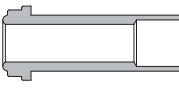
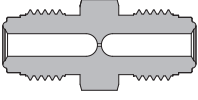
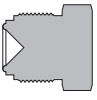
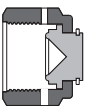

Configuration	Fitting Type	Example
	FR Gland to Short Tube Butt Weld	6LV-G-FR8-TB8-6S
	FR Gland to long Butt Weld	6LV-G-FR8-TB8-6
	FR Gland to Male Weld	6L-G-FR8-TB4
	FR Gland to Tube Socket Weld	SS-G-FR8-TS6
	FR Gland to Short Tube Socket Weld	SS-G-FR4-TS4-0.75
	FR Gland to Tube Port	SS-G-FR8-FT6
	Short Fractional Automatic Tube Butt Weld	SS-AG-FR4-TB4-12S
	Long Fractional Automatic Tube Butt Weld	SS-AG-FR4-TB4-12
	Blind Gland	SS-G-FR8-B
	FR Welded Gland to Male NPT	SS-WG-FR8-NS6
	FR Welded Gland to Female NPT	SS-WG-FR8-FNS6
	FR Welded Gland to Tube Fitting	SS-WG-FR8-FL8

Configuration	Fitting Type	Example
	FR Welded Gland Union	SS-WG-FR4
	Female Nut	SS-N-FR4
	Male Nut	SS-MN-FR8
	FR Body to Male NPT	SS-CM-FR8-NS4
	FR Body to Female NPT	SS-CF-FR8-NS4
	FR Body to Tube Fitting	SS-U-FR8-FL6
	FR Body to Bulkhead Tube Fitting Union	SS-UB-FR8-FL8
	FR Body to Bulkhead Male Connector	SS-CMB-FR8-NS4
	Union Body	SS-U-FR8
	Bulkhead Union Body	SS-BU-FR8
	FR Bulkhead Body to Tube Butt Weld	SS-BW-FR4-TB4
	Coupling	SS-BC-FR8
	Female Reducing Union	SS-RU-FR8-FR4
	Reducing Adapter	SS-RA-FR8-FR4

Configuration	Fitting Type	Example
	Reducing Bushing	SS-RB-FR8-FR4
	FR Body to Male NPT Elbow	SS-LM-FR8-NS6
	FR Body Union Elbow	SS-LU-FR8
	FR Body Union Tee	SS-TTT-FR8
	FR Body Union Cross	SS-C-FR6
	"H" Type Union Elbow	SSLUHFR4
	"H" Type Tube Butt Weld	SSCWHFR4TB6
	"H" Type Tube Butt Weld	SSGHFR4TB630.2
	Flow Restrictors	6LV-RFR4020
	Plug	SS-PG-FR4
	Cap	SS-CP-FR4
	Gasket	6L-GT-FR8

Part Number Description

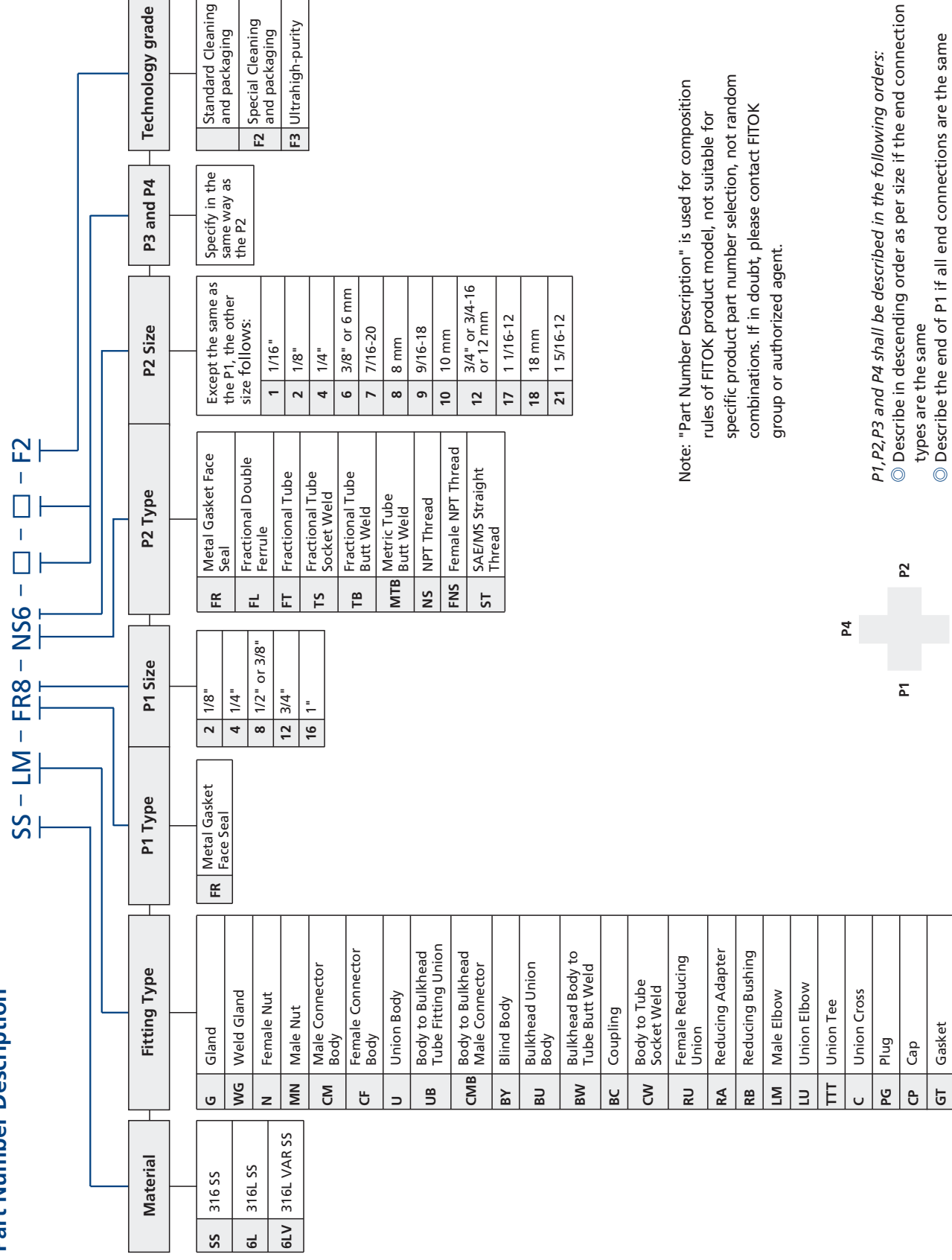













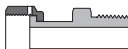
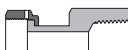
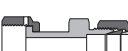





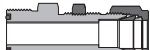

O-ring Face Seal Fittings

FO Series

- Sizes range from 1/8" to 1"
- 316 and 316L stainless steel materials are available
- O-ring seal provides perfect leak-tight service from vacuum to high pressure
- Glands and bodies are stamped with size, material, and heat code
- Fittings are easy to install and maintain
- FO female threads are silver plated



Configuration	Fitting Type	Example
	FO Gland to Tube Butt Weld	6LV-G-FO8-TB6
	FO Gland to Tube Socket Weld	6L-G-FO8-TS8
	FO Gland to Tube Port	SS-G-FO8-FT8
	FO Gland to Automatic Tube Weld	6L-G-FO4-TB4A
	FO Welded Gland to Male NPT	SS-WG-FO4-NS4
	FO Welded Gland to Female NPT	SS-WG-FO4-FNS4
	FO Welded Gland to Tube Fitting	SS-WG-FO8-FL6
	FO Welded Gland Union	SS-WG-FO4
	Female Nut	SS-N-FO8
	Blind Nut	SS-N-FO4-B
	FO Body to Male NPT	SS-CM-FO8-NS8
	FO Body to Female NPT	SS-CF-FO8-NS6

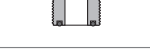



Configuration	Fitting Type	Example
	FO Body to Tube Fitting	SS-U-FO8-FL6
	FO Body to Automatic Tube Weld	6L-CW-FO4-TB4A
	FO Body to Bulkhead Tube Fitting Union	SS-UB-FO8-FL8
	Blind Body	SS-BY-FO8
	Union Body	SS-U-FO4
	Bulkhead Union Body	SS-BU-FO8
	FO Body to Tube Socket Weld	SS-CW-FO8-TS8
	FO Body to Male NPT Elbow	SS-LM-FO8-NS6
	FO Body to Tube Fitting Elbow	SS-LU-FO8-FL8
	FO Body Union Elbow	SS-LU-FO8
	FO Body Union Tee	SS-TTT-FO4

L-ring Face Seal Fittings

TFO Series

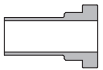
- Sizes range from 1/4" to 1"
- Materials:
Body, gland: 316L stainless steel
Nut: 316 stainless steel
- Reduced internal entrapment
- Lubricant-free L-ring seal
- Tube butt end connections
- Controlled L-ring extrusion, no overtightening



Configuration	Fitting Type	Example
	Gland	6L-G-TFO8-TB8
	Tube Butt Weld Body	6L-CW-TFO8-TB8
	Nut	SS-N-TFO8
	L-ring Seal	T-GT-TFO8

Valves

Diaphragm Valves

DQ Series

- 316L VIM-VAR stainless steel body is available
- Suitable for ultrahigh-purity applications
- Elgiloy material for strength and corrosion resistance for long cycle life
- Fully contained PCTFE seat design provides excellent resistance to swelling and contamination
- Wetted Surface Electropolished, Roughness Ra finished to an average of Ra5 µin.(0.13 µm)
- Helium leak tested, maximum leak rate of 1×10^{-9} std cm³/s
- Low-pressure and high-pressure models
- Manual or pneumatic actuation
- Aluminum piston accelerated open/close speed
- Different handle types and colors are available
- Can be used in vacuum applications



Manual Actuators

Round

- Quick, quarter-turn actuation
- Handle with window provides visual indication of open and closed positions



Integral Lockout

- Quick, quarter-turn actuation
- Lockable in the CLOSED position for safety
- Handle shape and window indicator provides visual indication of OPEN and CLOSED position

Pneumatic Actuator

- Normally open, "N.O." marked on the top of the cylinder
- Normally close, "N.C." marked on the top of the cylinder



Multiport and Elbow Valves

Designator	Schematic	Flow Path		Designator	Schematic	Flow Path	
		Closed	Open			Closed	Open
2A				3D			
2B				3E			
2C				3F			
4M				3G			
4N				3K			

End Connections

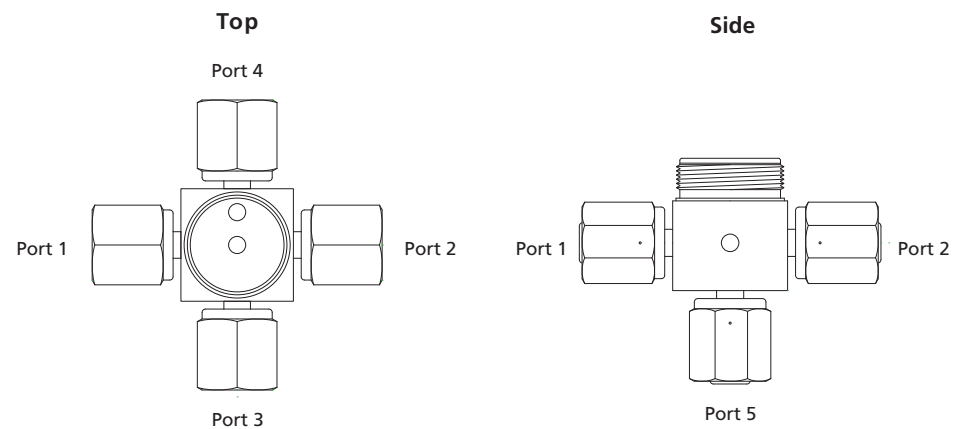

Multivalve Manifolds

Designator	Schematic	Flow Path
V		
W		
D		

V and W Multivalve Manifolds

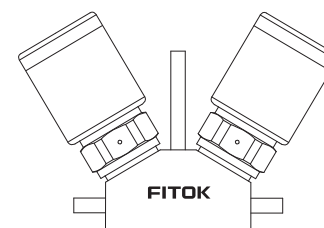

D Multivalve Manifold

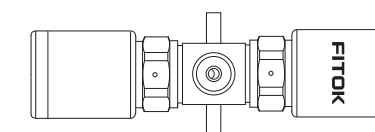

Part Number Description

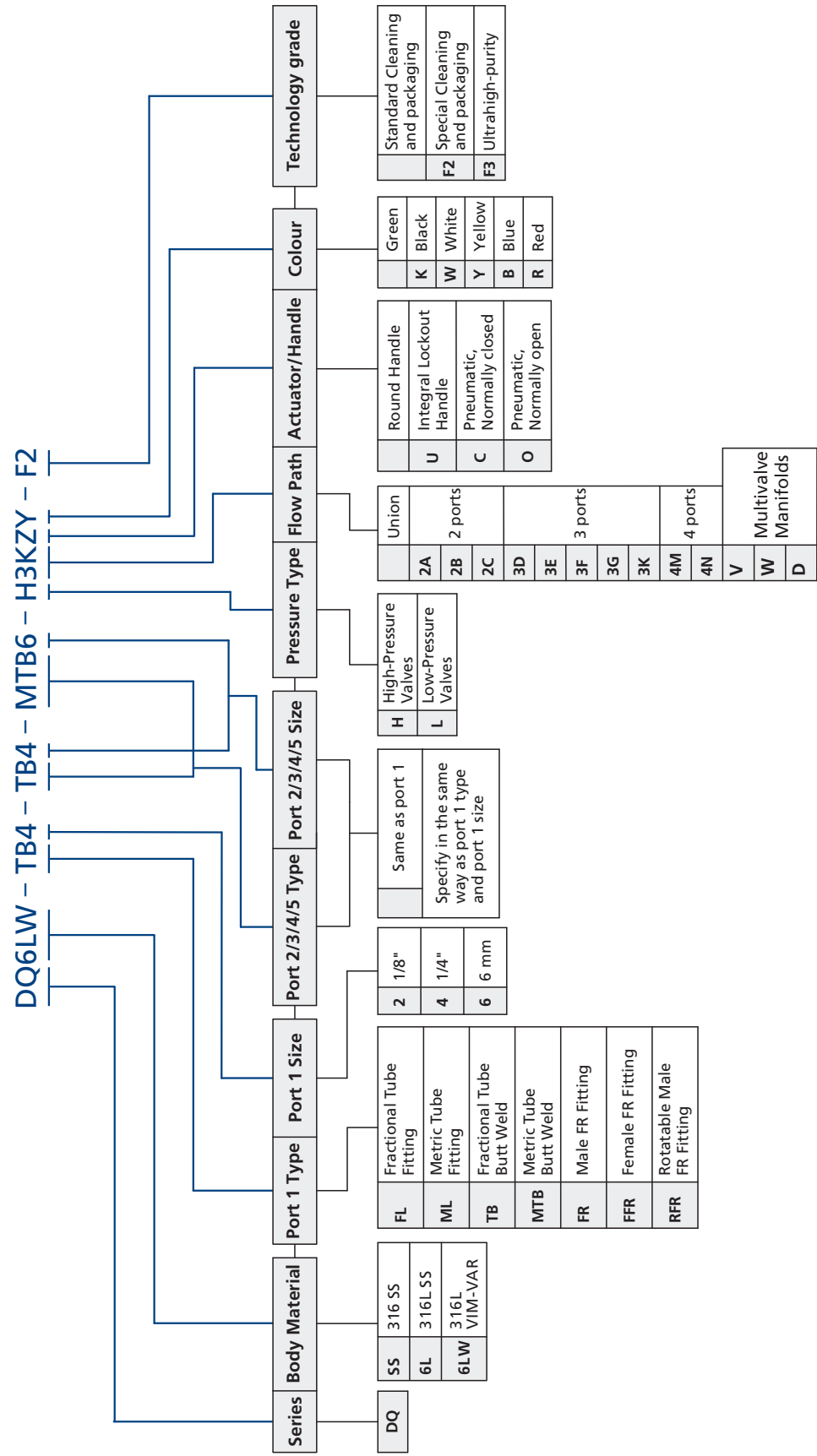

Note: "Part Number Description" is used for composition rules of FITOK product model, not suitable for specific product part number selection, not random combinations. If in doubt, please contact FITOK Group or authorized agent.

DM Series

- All-metal containment, packless
- Repetitive shutoff with fully contained softseat stem tip
- Position indicator ring for lever handle
- Manual or pneumatic actuation
- Aluminum piston accelerated open/close speed
- Helium leak tested, maximum leak rate of 4×10^{-9} std cm^3/s
- Different handle types and colors are available
- Can be used in vacuum applications



Straight Patterns

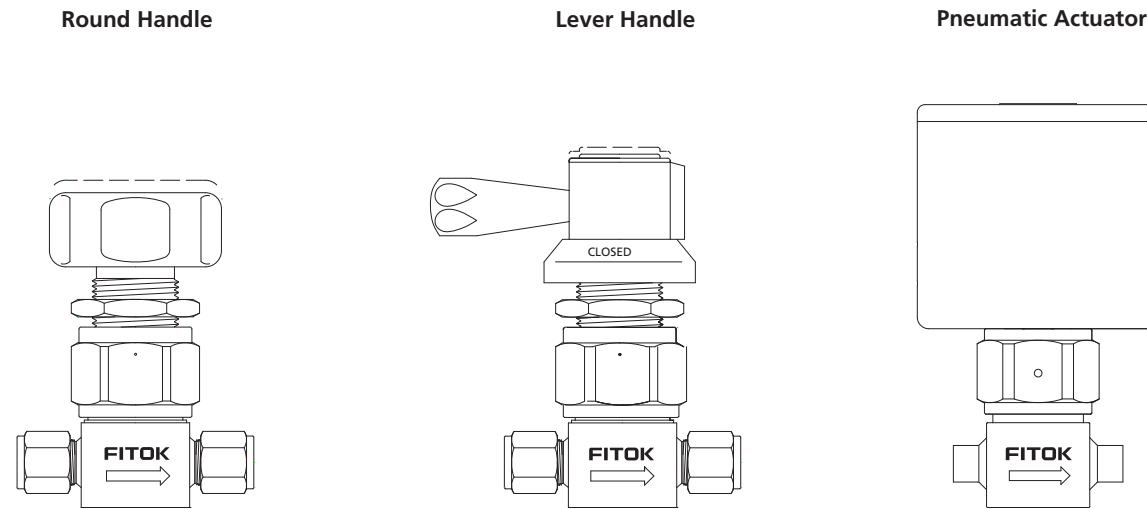

Angle Patterns

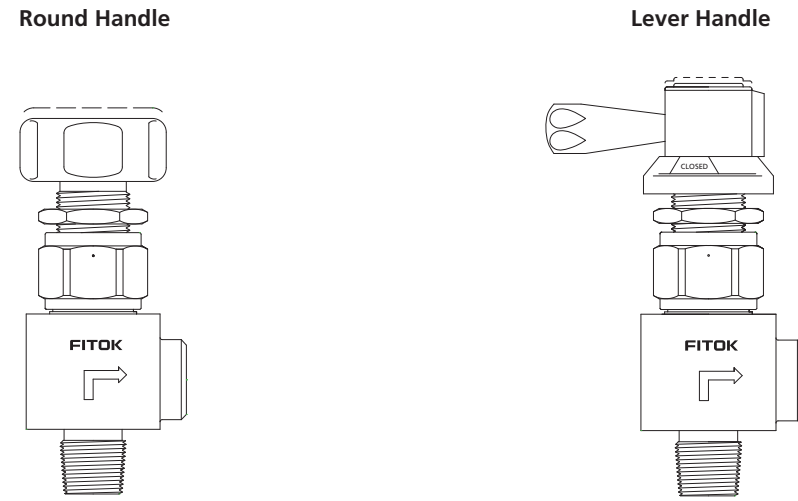

Part Number Description

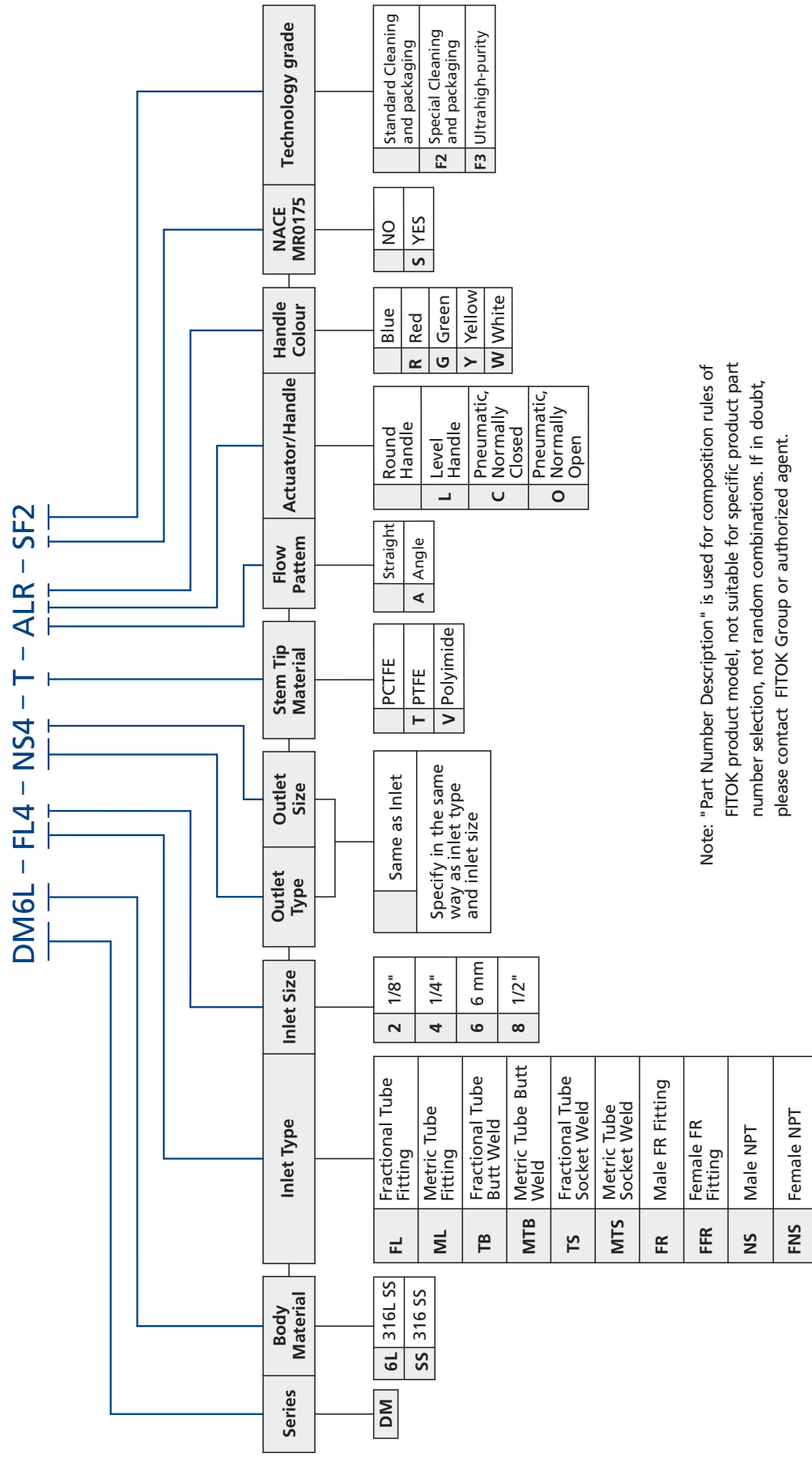

Note: "Part Number Description" is used for composition rules of FITOK product model, not suitable for specific product part number selection, not random combinations. If in doubt, please contact FITOK Group or authorized agent.

Pressure Reducing Regulator



Compact Pressure Reducing Regulator

PR Series

- ⦿ Maximum inlet pressure: 500, 3000 psig
- ⦿ Outlet pressure ranges: 0~25, 0~50, 0~100, 0~250, 0~500 psig
- ⦿ Flow coefficient (Cv):
500 psig Inlet pressure: 0.15
3000 psig Inlet pressure: 0.06
- ⦿ Working temperature: -40°F~+165°F (-40°C~+74°C)
- ⦿ Leak rate:
Internal: Bubble-tight
External: ≤2x10⁻⁸ atm · cc/sec He
- ⦿ Convoluted diaphragm provides accurate pressure adjustment
- ⦿ Metal-to-metal diaphragm seal
- ⦿ Spring loaded pressure reducing regulator
- ⦿ A filter installed in inlet
- ⦿ Panel mounting available

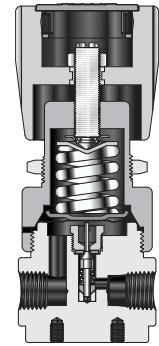

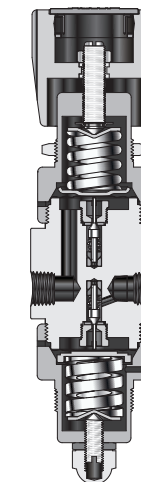

Two Stage Pressure Reducing Regulator

PD Series

- Maximum inlet pressure: 3000 psig
- Outlet pressure ranges: 0~25, 0~50, 0~100, 0~150, 0~250 psig
- Flow coefficient (Cv): 0.05
- Working temperature: -40°F~+165°F (-40°C~+74°C)
- Leak rate:
 - Internal: Bubble-tight
 - External: $\leq 2 \times 10^{-8}$ atm · cc/sec He
- Accurate and stable outlet pressure
- Two-stage pressure reducing construction
- Diaphragms are convoluted for greater accuracy and sensitivity
- Filter installed in inlet
- Panel mounting available

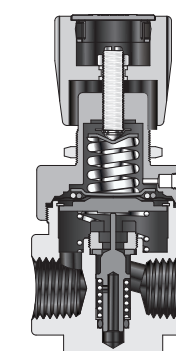

High Flow Pressure Reducing Regulator

PL Series

- Maximum inlet pressure: 500 psig
- Outlet pressure ranges: 0~15, 0~30, 0~75, 0~150 psig
- Flow coefficient (Cv): 1.8
- Working temperature: -40°F~+165°F (-40°C~+74°C)
- Leak rate:
 - Internal: Bubble-tight
 - External: $\leq 2 \times 10^{-8}$ atm · cc/sec He
- Large diameter convoluted diaphragm for increased pressure sensitivity
- Metal-to-metal diaphragm seal
- Large flow, minimal droop
- Panel mounting available

Porting configurations

6 Types: A, B, C, D, E, F, all ports are 1/4" Female NPT.
 HP: High pressure inlet LP: Low pressure outlet

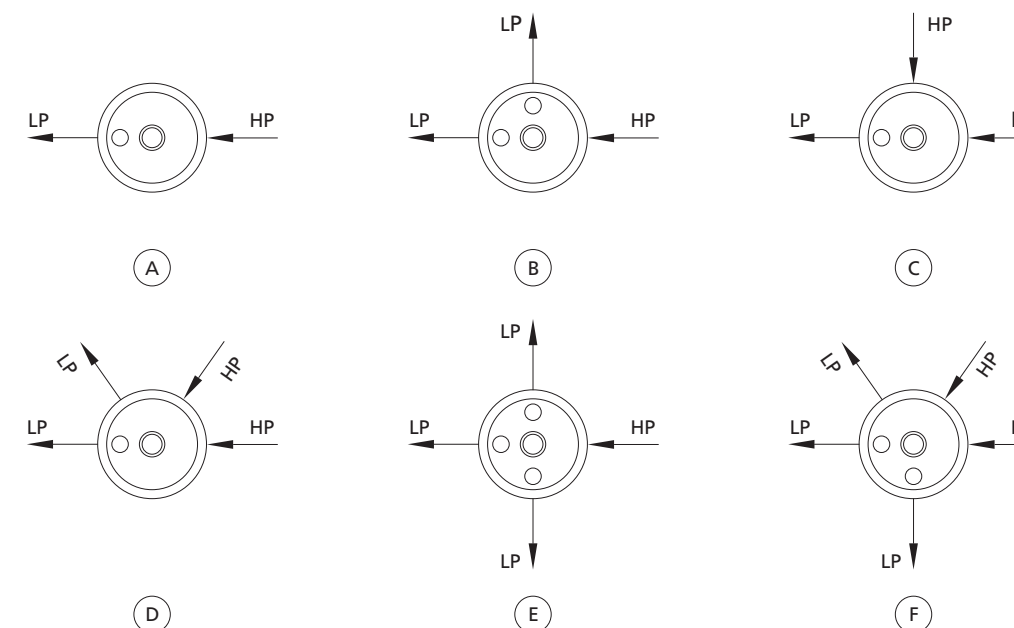

Extremely Sensitive Pressure Reducing Regulator

PS Series

- Maximum inlet pressure: 500, 3000 psig
- Outlet pressure ranges: 0~25, 0~50, 0~100, 0~150, 0~200 psig
- Flow coefficient (Cv):
 - 500 psig Inlet pressure: 0.15
 - 3000 psig Inlet pressure: 0.06
- Working temperature: -40°F~+165°F (-40°C~+74°C)
- Leak rate:
 - Internal: Bubble-tight
 - External: $\leq 2 \times 10^{-8}$ atm · cc/sec He
- Large convoluted diaphragm for extreme sensitivity
- Metal-to-metal diaphragm seal
- Extreme sensitivity: $\pm 1\%$ of outlet pressure range
- Good repeatability
- A filter installed in inlet
- Panel mounting available

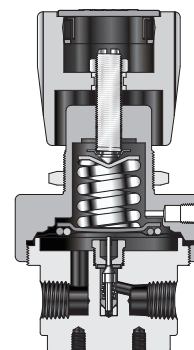

Medium Flow Pressure Reducing Regulator

PM Series

- Maximum inlet pressure: 500, 3000 psig
- Outlet pressure ranges: 0~25, 0~50, 0~100, 0~150, 0~200 psig
- Flow coefficient (Cv): 1.0
- Working temperature: -40°F~+140°F (-40°C~+60°C)
- Leak rate:
 - Internal: Bubble-tight
 - External: $\leq 2 \times 10^{-8}$ atm · cc/sec He
- Large diameter convoluted diaphragm for increased pressure sensitivity
- Metal-to-metal diaphragm seal
- Large flow, minimal droop
- Panel mounting available

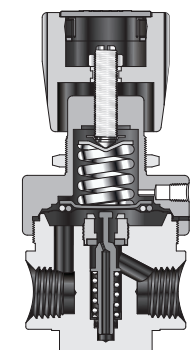

General High Pressure Reducing Regulator

PH Series

- Maximum inlet pressure: 3000, 6000 psig
- Outlet pressure ranges: 0~250, 0~500, 0~1500, 0~2500 psig
- Flow coefficient (Cv):
 - Non-vent: 0.06
 - Vent: 0.1
- Working temperature: -15°F~+165°F (-26°C~+74°C)
- Leak rate:
 - Internal: Bubble-tight
 - External: Bubble-tight
- Robust piston sensed design
- A filter installed in inlet
- Venting model optional
- Panel mounting available

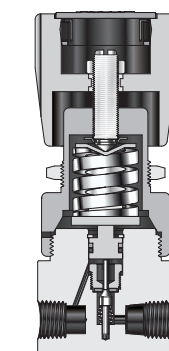

Part Number Description

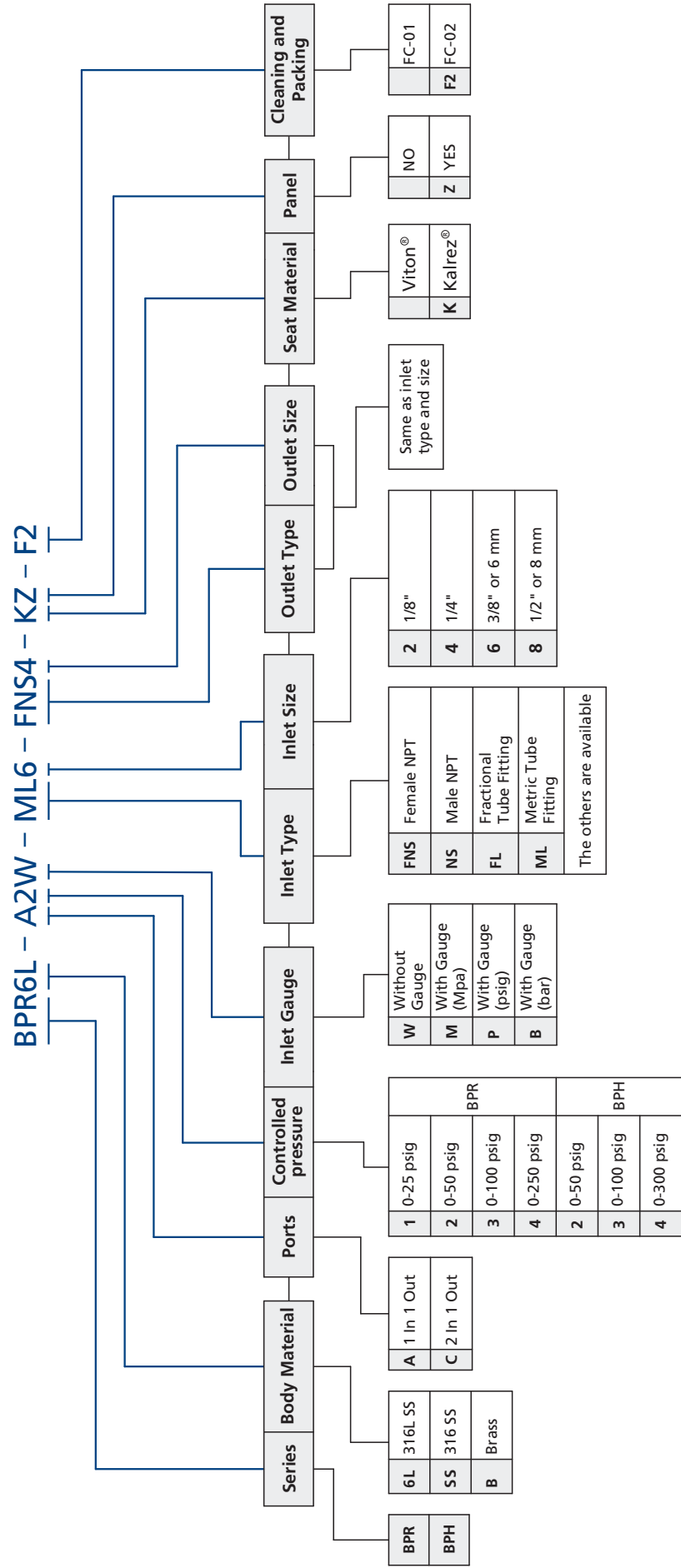

Note: "Part Number Description" is used for composition rules of FITOK product model, not suitable for specific product part number selection, not random combinations. If in doubt, please contact FITOK Group or authorized agent.

Changeover System

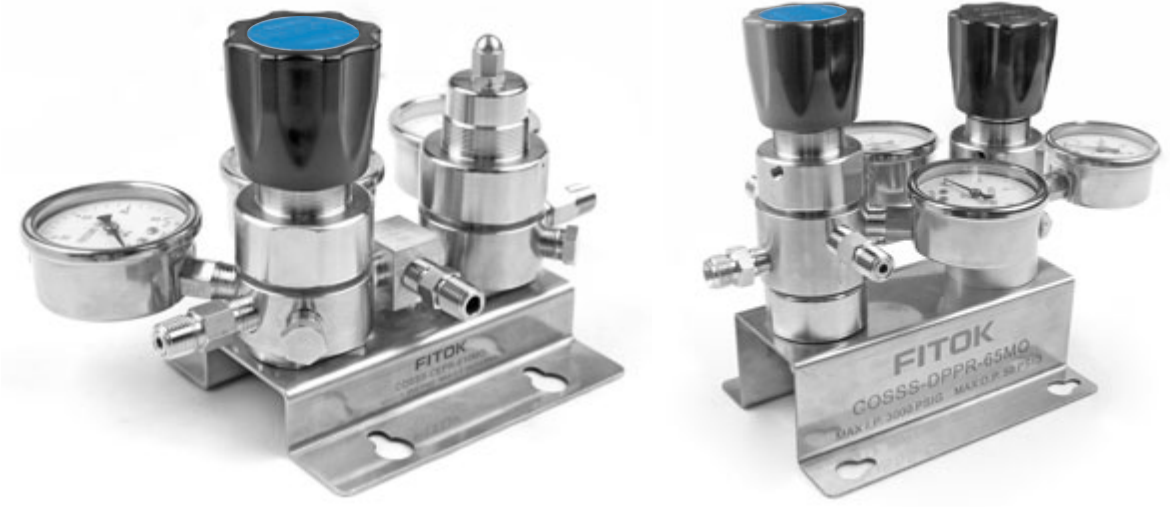

CEPR Series

- Maximum inlet pressure: 3000 psig
- Outlet pressure ranges: 85~115, 135~165, 185~215, 235~265 psig
- Flow coefficient (Cv): 0.06
- Working Temperature: -40°F~+165°F (-40°C~+74°C)
- Leak rate:
Internal: Bubble-tight
External: $\leq 2 \times 10^{-8}$ atm · cc/sec He
- Based on FITOK's PR series regulator
- Mounting bracket standard

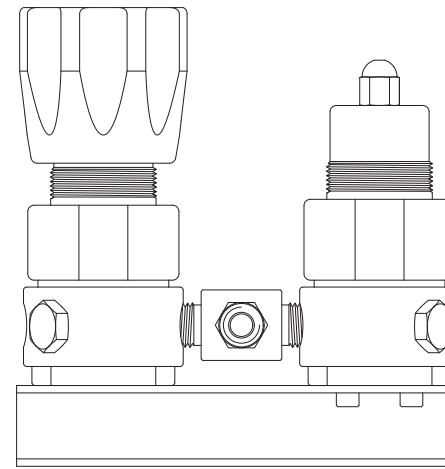

DPPR Series

- Maximum inlet pressure: 3000 psig
- Outlet pressure ranges: 0~25, 0~50, 0~100, 0~150 psig
- Flow coefficient (Cv): 0.06
- Working temperature: -40°F~+165°F (-40°C~+74°C)
- Leak rate:
Internal: Bubble-tight
External: $\leq 2 \times 10^{-8}$ atm · cc/sec He
- Based on FITOK's PR series regulator
- Mounting bracket standard

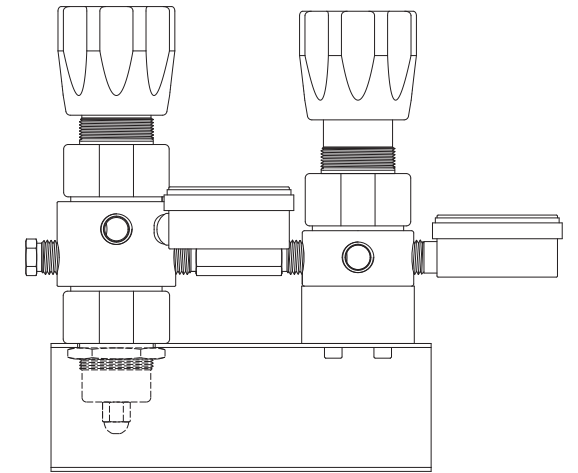

Part Number Description

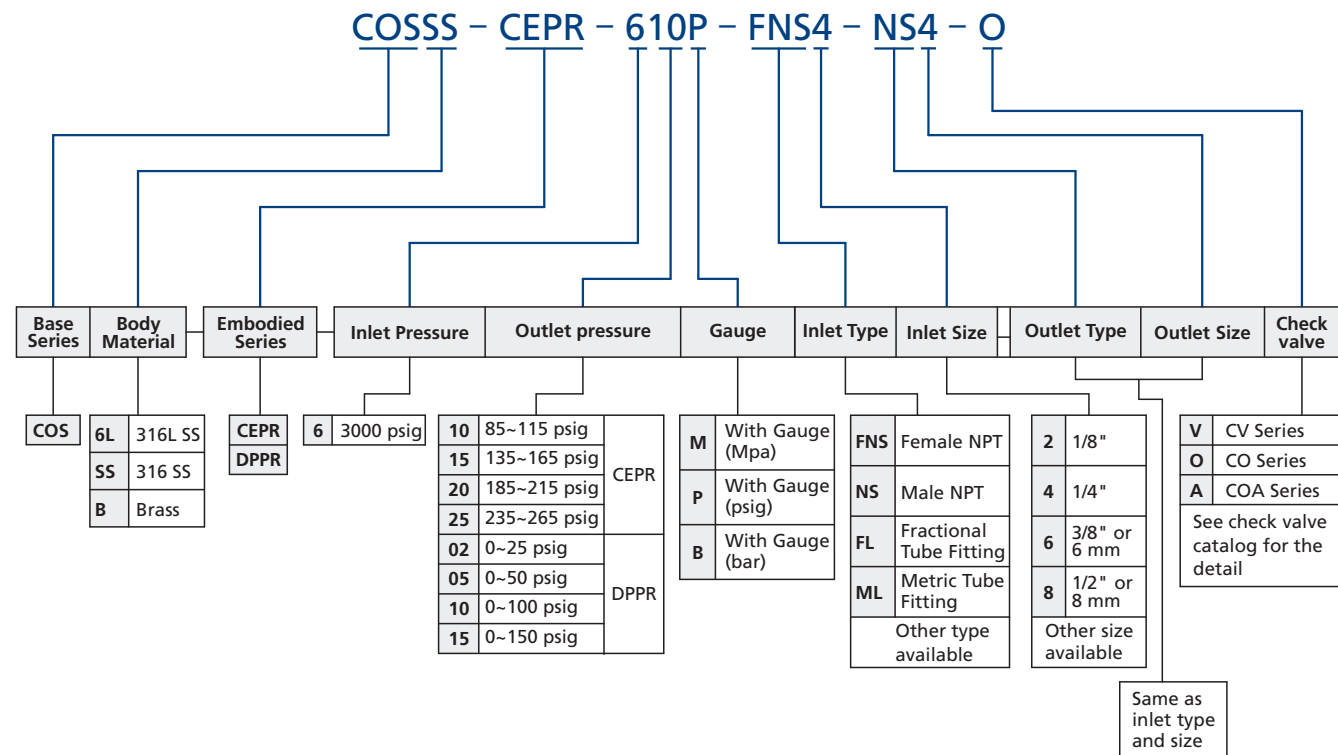

Note: "Part Number Description" is used for composition rules of FITOK product model, not suitable for specific product part number selection, not random combinations. If in doubt, please contact FITOK Group or authorized agent.

Closed-loop Sampling System

- Two kinds of optional sampling containers: Bottles and Cylinders.
- System main body material: 316 SS, 316L SS, 304L SS etc (Can be customized)
- Connection: 1/4" Tube fitting, 1/2" NPT Thread or NPS 1/2" Flange (Can be customized)
- Working temperature and pressure range: can be customized according to customers' requirements
- Applicable working conditions: High temperature, high pressure, high viscosity, strong corrosive, strong toxicity and hazardous liquid bane to the environment
- Various mounting way

B-Bottle Configuration Sampling System

L Series-Liquid Sampling

SBLA1-On-off Configuration

- Sampling directly from process or system, low pressure application

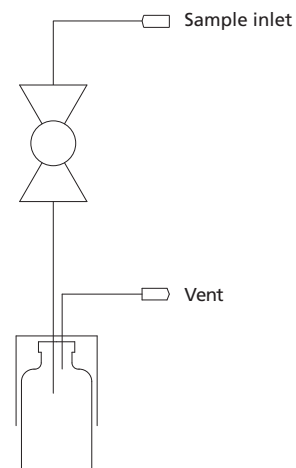

Schematic diagram

SBLA2-Circulation Configuration

- Sampling directly from process or system, low pressure application
- Sample circulation

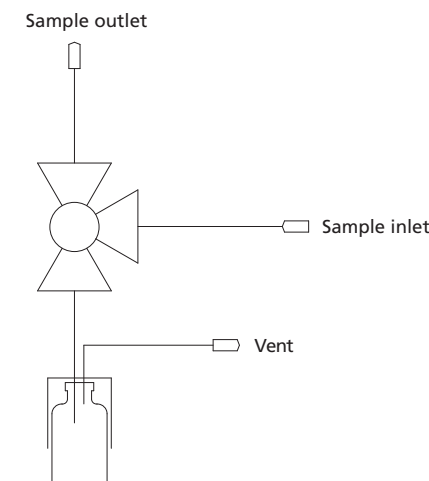

Schematic diagram

SBLA3-Back Flow Configuration

- Sampling directly from process or system, low pressure application
- Back flow

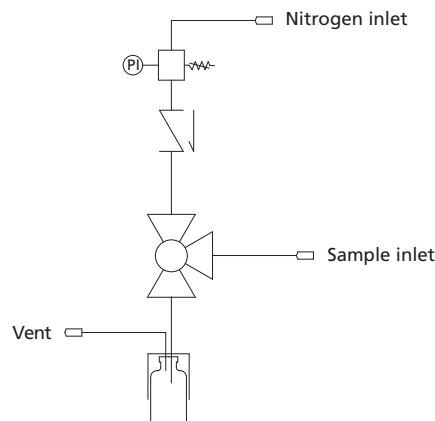

Schematic diagram

SBLA4-Air Replaced and System Purge Configuration I

- Sampling directly from process or system, low pressure application
- System purge
- Bottle air replaced

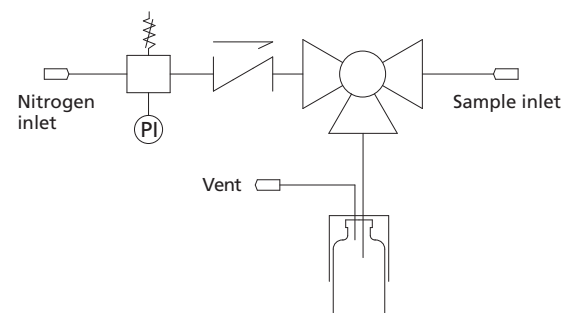

Schematic diagram

SBLB1-Flange On-off Configuration

- Applicable for sampling from process and container
- Sampling directly from process and container

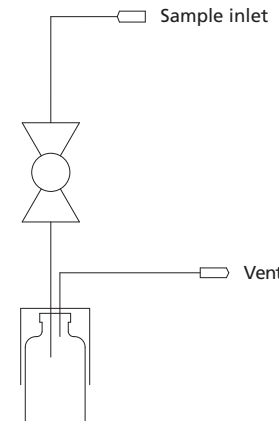

Schematic diagram

SBLB2-In Line and Circulation Configuration

- In line sampling
- Sample circulation
- Suitable for viscous liquid or liquid with few solid particles

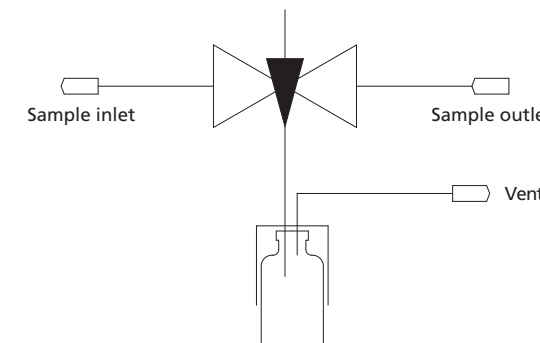

Schematic diagram

SBLA5-Back Flow, Air Replaced and System Purge Configuration

- Sampling directly from process or system, low pressure application
- System purge
- Back flow and bottle air replaced

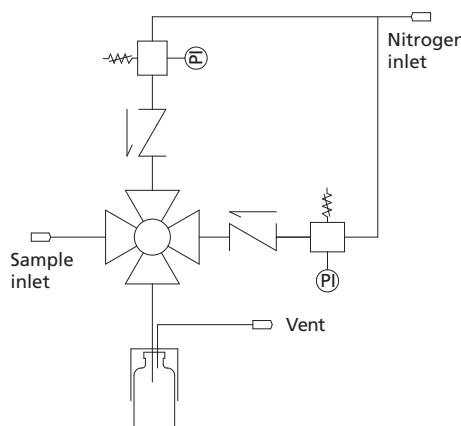

Schematic diagram

SBLA6-Air Replaced, Circulation and Needle Purge Configuration

- Sampling directly from process or system, low pressure application
- Needle purge
- Sample circulation and bottle air replaced

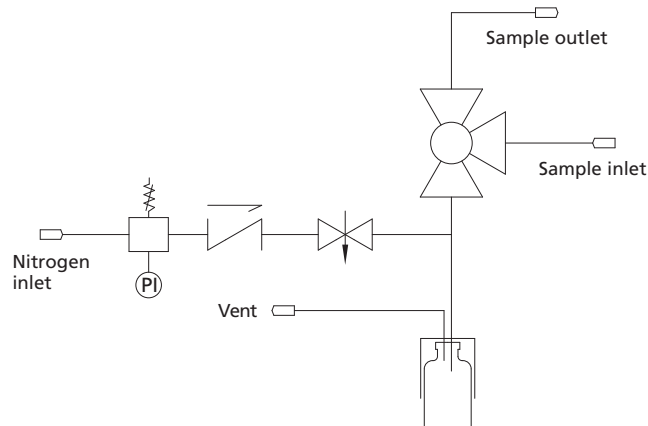

Schematic diagram

SBLB3-In Line, Air Replaced and Needle Purge Configuration

- In line sampling
- Bottle air replaced
- Suitable for viscous liquid or liquid with few solid particles
- Needle purge

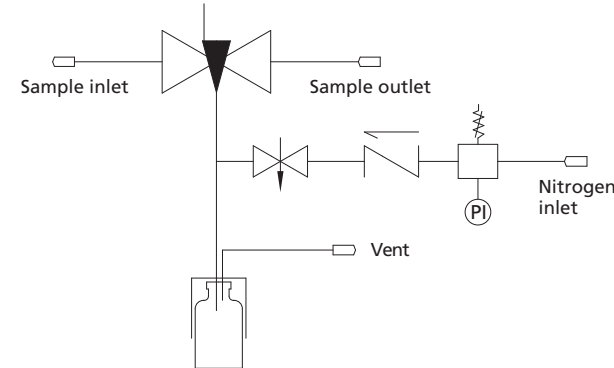

Schematic diagram

SBLC1-Air Replaced and System Purge Configuration II

- Sampling directly from process or system
- System purge
- Bottle air replaced
- Suitable for high viscous liquid

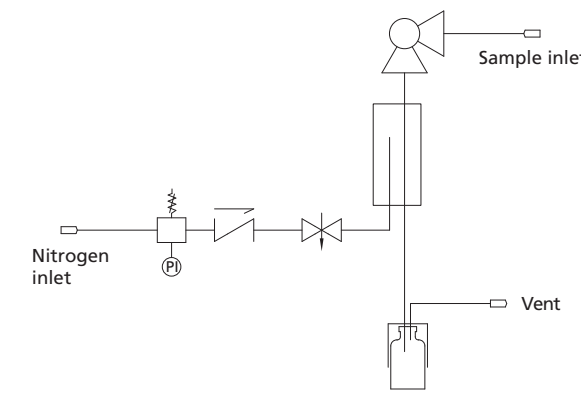

Schematic diagram

SBLC2-Fixed Volume, Air Replaced and System Purge Configuration

- Sampling directly from process or system
- Bottle air replaced
- Fixed volume
- Suitable for high viscous liquid
- System purge

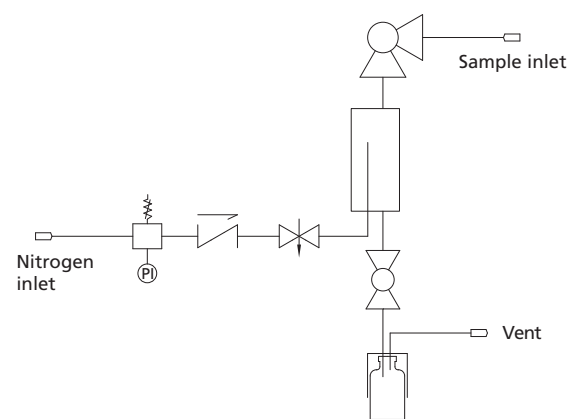

Schematic diagram

SBLC3-Heating/cooling, Fixed Volume, Air Replaced and System Purge Configuration

- Sampling directly from process or system
- Bottle air replaced
- Fixed volume
- Suitable for high viscous liquid
- Heating/Cooling jacket ensures sampling at the required temperature
- System purge

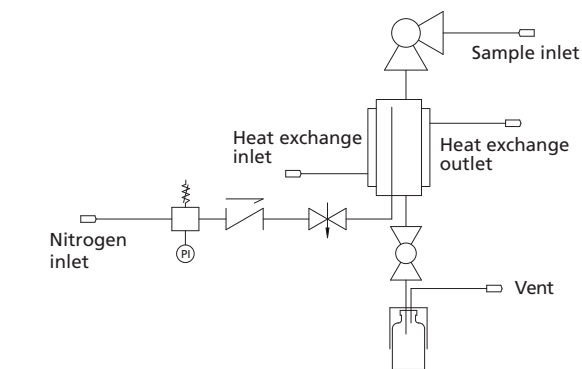

Schematic diagram

SBLD2-Fixed Volume, Circulation, Air Replaced and System Purge Configuration

- Sampling directly from process or system
- Fixed volume
- Bottle air replaced
- System purge
- Linkage ball valve design, easy operation
- Sample circulation

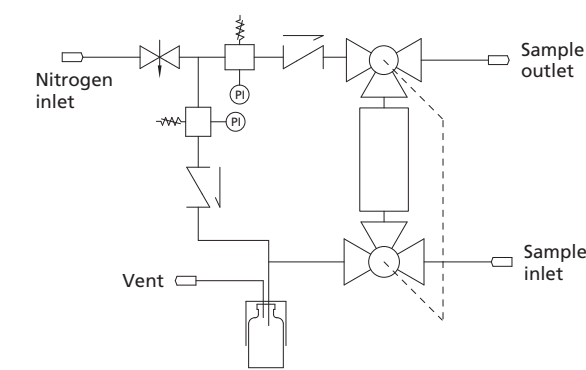

Schematic diagram

SBLD3-Heating/Cooling, Circulation, Fixed Volume and System Purge Configuration

- Sampling directly from process or system
- Fixed volume
- Sample circulation
- System purge
- Heating/Cooling jacket ensures sampling at the required temperature
- Linkage ball valve design, easy operation

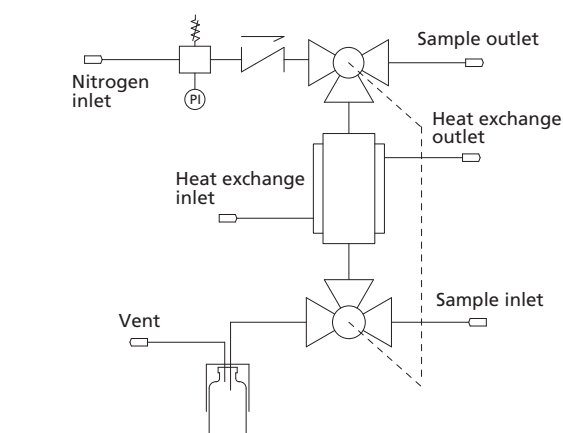

Schematic diagram

SBLC4-Solvent Purge, Air Replaced and System Purge Configuration

- Sampling directly from process or system
- Bottle air replaced and solvent purge
- Suitable for high viscous liquid
- Solvent purge and system purge function

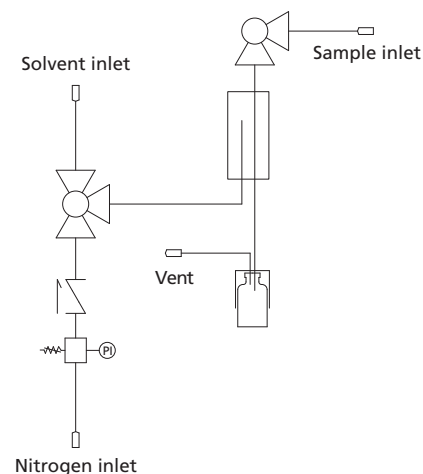

Schematic diagram

SBLD1-Fixed Volume, Circulation and System Purge Configuration

- Sampling directly from process or system
- Fixed volume
- Sample circulation
- System purge
- Linkage ball valve design, easy operation

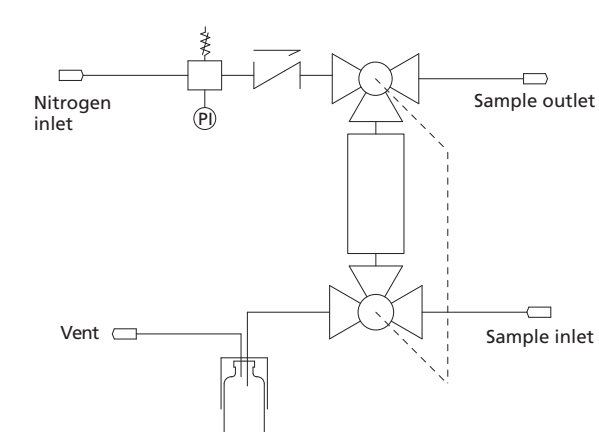

Schematic diagram

SBLE1-Back Flow and Vacuum Configuration

- Sampling directly from process or system
- Applicable for zero-pressure or vacuum process
- Back flow
- Linkage ball valve design, easy operation

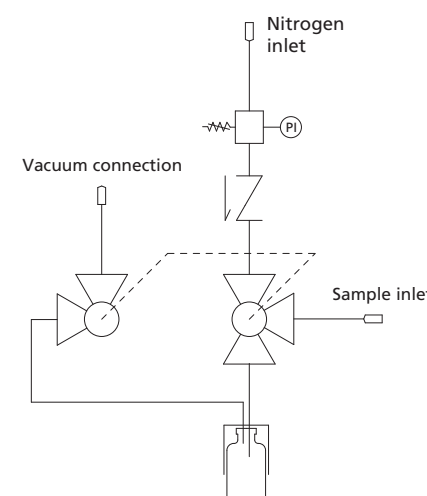

Schematic diagram

SBLE2-Back Flow, Air Replaced, Vacuum and System Purge Configuration

- Sampling directly from process or system
- Applicable for zero-pressure or vacuum process
- Back flow and bottle air replaced
- Linkage ball valve design, easy operation
- System purge

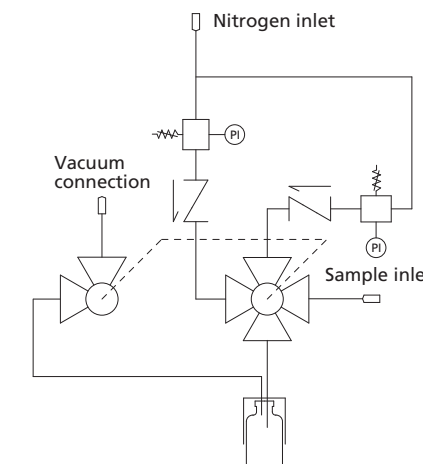

Schematic diagram

SBLE3-Back Flow and Venturi Configuration

- Sampling directly from process or system
- Applicable for zero-pressure or vacuum process
- Back flow
- Linkage ball valve design, easy operation

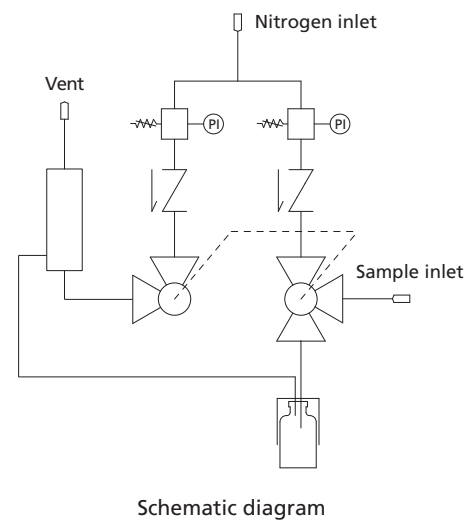

Schematic diagram

SBLE4-Back Flow, Air Replaced, Venturi and System Purge Configuration

- Sampling directly from process or system
- Applicable for zero-pressure or vacuum process
- Back flow and bottle air replaced
- Linkage ball valve design, easy operation
- System purge

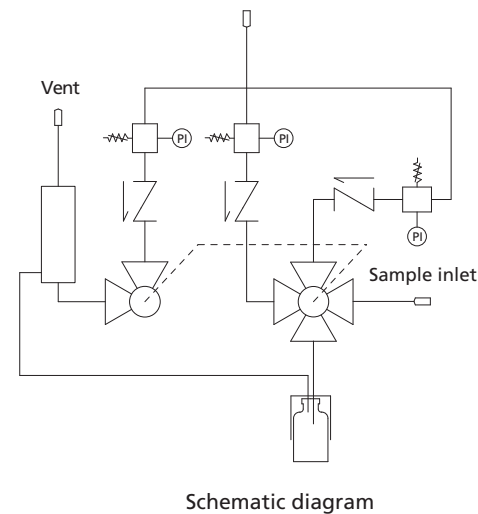

Schematic diagram

SBLE5-Vacuum, Overflow, Fixed Volume, Back Flow and System Purge Configuration

- Sampling directly from process or system
- Applicable for zero-pressure or vacuum process
- Fixed volume
- Back flow and overflow
- Linkage ball valve design, easy operation
- System purge

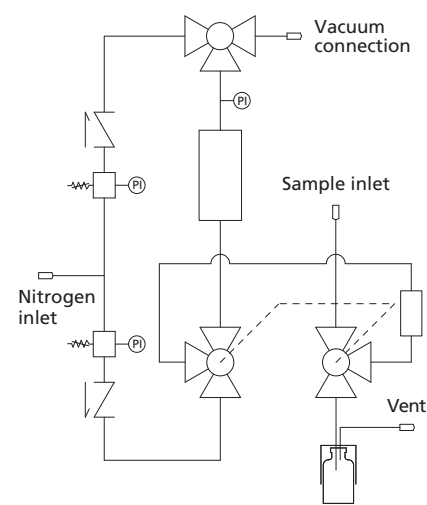

Schematic diagram

C-Cylinder Configuration Sampling System S Series-Liquefied Gas Sampling

SCSF1-Expansion Chamber Configuration

- Sampling directly from process or system
- Sample circulation
- Equipped with pressure relief system, safer for sampling
- Linkage ball valve design, easy operation

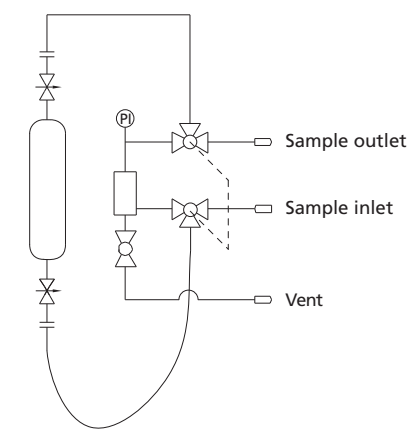

Schematic diagram

SCSF2-Expansion Chamber Purge Configuration

- Sampling directly from process or system
- Sample circulation and expansion chamber purge
- Equipped with pressure relief system, safer for sampling
- Linkage ball valve design, easy operation

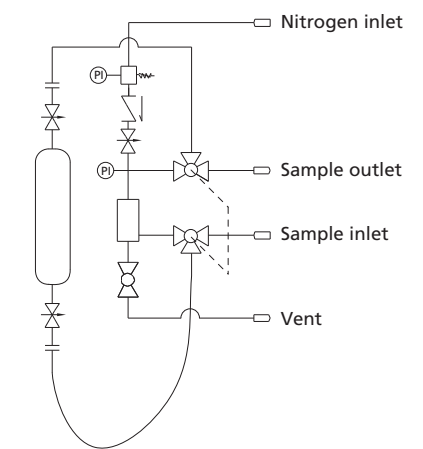

Schematic diagram

SCSF3-Expansion Chamber, Bypass and System Purge Configuration

- Sampling directly from process or system
- Sample circulation and system purge
- Equipped with pressure relief system, safer for sampling
- Linkage ball valve design, easy operation

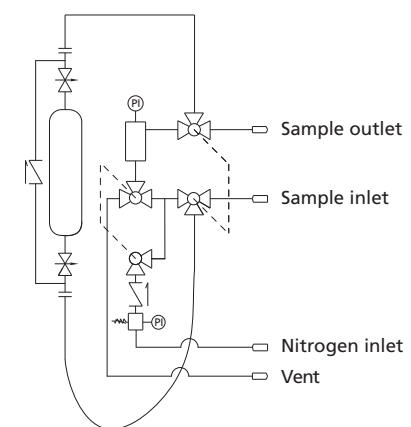

Schematic diagram

SCSF4-Expansion Chamber and Outlet to Flare Configuration

- Sampling directly from process or system
- Applicable for sampling from process or system without process out connection
- Equipped with pressure relief system, safer for sampling
- Linkage ball valve design, easy operation

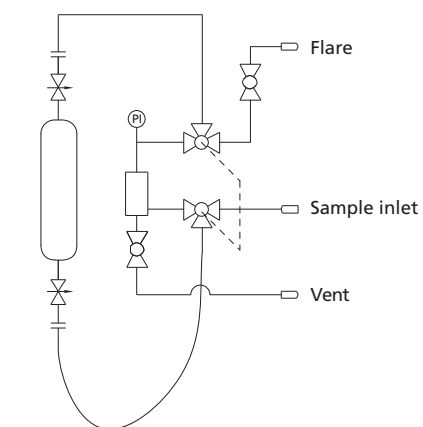

Schematic diagram

SCSF5-Outage Tube Configuration

- Sampling directly from process or system
- Sample circulation
- Outage tube within cylinder keep the cylinder safe
- Linkage ball valve design, easy operation

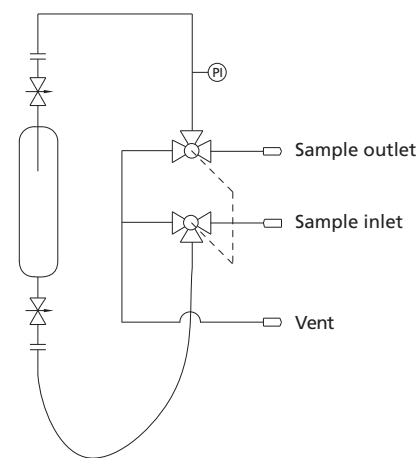

Schematic diagram

SCSF6-Outage Tube, Bypass and System Purge Configuration

- Sampling directly from process or system
- Sample circulation and system purge
- Outage tube within cylinder keep the cylinder safe
- Linkage ball valve design, easy operation

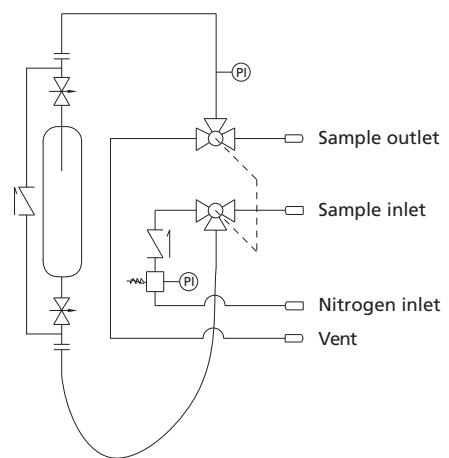

Schematic diagram

SCSF7-Outage Tube and Outlet to Flare Configuration

- Sampling directly from process or system
- Applicable for sampling from process or system without process out connection
- Outage tube within cylinder keep the cylinder safe
- Linkage ball valve design, easy operation

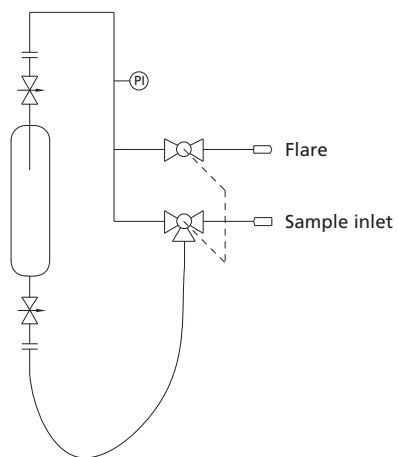

Schematic diagram

G Series-Gas Sampling

SCGG1-Circulation Configuration

- Sampling directly from process or system
- Sample circulation
- Linkage ball valve design, easy operation

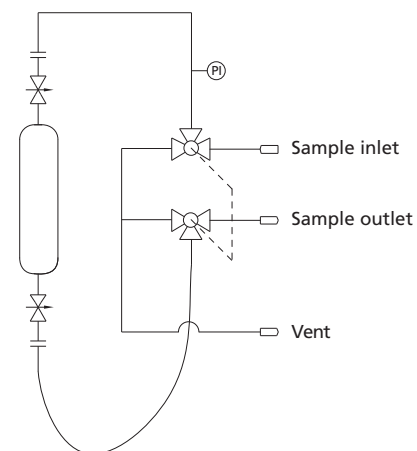

Schematic diagram

SCGG2-Bypass and System Purge Configuration

- Sampling directly from process or system
- Sample circulation and system purge
- Linkage ball valve design, easy operation

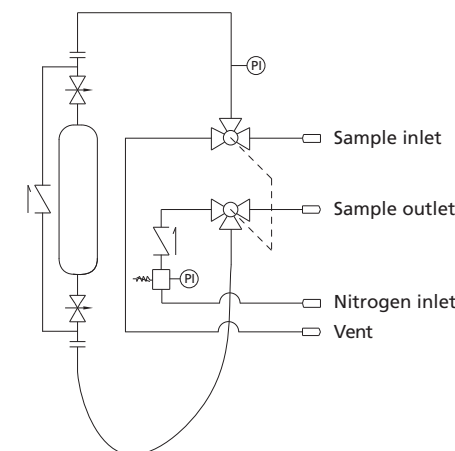

Schematic diagram

SCGG3-Outlet to Flare Configuration

- Sampling directly from process or system
- Applicable for sampling from process or system without process out connection
- Linkage ball valve design, easy operation

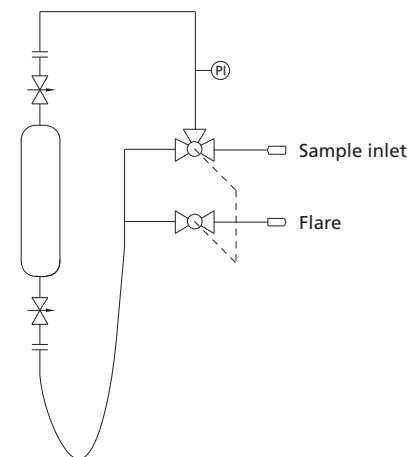

Schematic diagram