

OWLE/F Series / Laser Distance Sensors

Triangulation (up to 1 m)



LASER RADIATION
DO NOT STARE INTO BEAM
Wavelength: 620...680nm
Max. av. Output: <1mW
IEC 60825-1, Ed. 2, 2007
CLASS 2 LASER PRODUCT

Complies with 21 CFR 1040.10 and 1040.11 except for deviations pursuant to laser notice No. 50, dated June 24, 2007

Laser distance sensors in the OWLE/F series are real all-rounders. For almost any application is a suitable version. We offer the OWLE/F family with different interfaces, measuring ranges, resolutions and measuring frequencies. The robust IP67 metal housing protected sensors using the laser triangulation principle.

- Excellent linearity by microprocessor control
- Teach-In of measurement range
- Laser line for measurement on rough surfaces
- Linearity optimizable by teach-in function
- Laser protection class 2
- Robust IP67 protected metal housing

OWLE/F

GENERAL DATA	
Measurement method	Triangulation
Light source	Laser
Wavelength	650 nm
Laser class	2
Receiving element	Position Sensitive Device (PSD)
Teach-in	Button / External (if existing)
Power on indication	LED green
Display alarm / pollution	LED red
Electronic	Integrated
MEASUREMENT DATA	
Baud rate	19200 bps
POWER SUPPLY	
Power supply	12 - 28 V DC
Power consumption max.	100 mA
Load resistance (analog I)	< (+Vs - 6V) / 0.02 A
Load resistance (analog U)	> 100 kΩ
Short circuit protection	Yes (except OWLF 4100 K Sp L)
Reverse polarity protection	Yes
PHYSICAL CHARACTERISTICS	
Housing	Type 1: 20.6 x 65 x 50 mm, die-cast zinc, 131 g Type 2: 20.4 x 135 x 45 mm, aluminium, 162 g
Front (optics)	Glass
Ingress protection	IP67
Construction type	Rectangular
ENVIRONMENTAL	
Operating temperature range	0 - +50 °C (except OWLF 4xxx FA K Sp L (-20 - +60 °C))

Industrial Sensors / Laser & LED Distance Sensors

Measuring distance (mm)	Resolution (mm)	Linearity error ± (mm)	Measuring frequency	Temperature drift (Sde/K)	Teach-in:	Beam type	Beam ø (mm)	Teach-in range min.	Response time / release time	Output circuit	Output signal	Current consumption max.	Alarm output	Housing-type	Connection type	Ordercode							
COMPARISON CHART OWLE/F SENSORS																							
30 - 50	0.01	0.03	100 Hz	< 0.015 %	-	Point	0.4 - 1	-	< 10 ms	RS-485	-	< 100 mA	push-pull	1	Connector M12 8-pin	OWLE 4005 AD S1							
						Line	0.4 - 2									OWLE 4005 AD S1 L							
30 - 70	0.004 - 0.02	0.012 - 0.06	1100 Hz	-	•	Point	0.2 - 1	> 2 mm	< 0.9 ms	analog	4 - 20 mA	-	-	1	Connector M12 5-pin	OWLE 5007 AE S1							
				< 0.015 %			1 - 2				OWLE 5007 AA S1												
				Line		0.2 - 2	4 - 20 mA / 0 - 10 V				< 100 mA					PNP	Connector M12 8-pin	OWLF 4007 FA S1					
						OWLF 4007 FA S1 L																	
30 - 130	0.005 - 0.06	0.015 - 0.2	1100 Hz	-	•	Point	0.2 - 1	> 3 mm	< 0.9 ms	analog	4 - 20 mA	-	-	1	Connector M12 5-pin	OWLE 5013 AE S1							
				< 0.03 %			1 - 2				OWLE 5013 AA S1												
				Line		1 - 2	4 - 20 mA / 0 - 10 V				< 100 mA					PNP	Connector M12 8-pin	OWLF 4013 FA S1					
	Point	1 - 5	-	< 10 ms	RS-485	-	push-pull	OWLF 4013 FA S1 L															
	Line	1 - 2						OWLE 4013 AD S1															
		0.05 - 0.07	0.15 - 0.22	100 Hz	-	-	Line	1 - 5	-	< 10 ms	RS-485	-	-	1	Connector M12 8-pin	OWLE 4013 AD S1 L							
50 - 250	0.1 - 0.3	0.3 - 0.8	100 Hz	< 0.03 %	-	Point	2	-	< 10 ms	RS-485	-	< 100 mA	push-pull	1	Connector M12 8-pin	OWLE 4025 AD S1							
				-		Line	2.5 - 10			analog					4 - 20 mA / 0 - 10 V	PNP	Connector M12 5-pin	OWLE 4025 AD S1 L					
				Point		2	OWLE 4025 AE S1																
50 - 300	0.01 - 0.33	0.03 - 1	1100 Hz	-	•	Point	2	> 5 mm	< 0.9 ms	analog	4 - 20 mA	-	-	1	Connector M12 5-pin	OWLE 5030 AE S1							
				< 0.03 %			0 ~ 10 V				OWLE 5030 AA S1												
	Line	2.5 - 12	4 - 20 mA / 0 - 10 V	< 100 mA		PNP	Connector M12 8-pin				OWLF 4030 FA S1												
		< 0.04 %	2 - 11	-		-	Cable 8-pin, 2 m				OWLF 4030 FA S1 L												
	0.01 - 0.4	0.2 - 1.5	500 Hz	< 0.04 %	-	Line	2 - 11	< 2 ms	-	-	-	-	1	Cable 8-pin, 2 m	OWLF 4030 FA K Sp L								
100 - 500	0.2 - 0.5	0.8 - 2	100 Hz	< 0.04 %	-	Point	2	-	< 10 ms	RS-485	-	< 100 mA	push-pull	1	Connector M12 8-pin	OWLE 4050 AD S1							
				Line		2.5 - 18	OWLE 4050 AD S1 L																
100 - 600	0.015 - 0.67	0.05 - 2	1100 Hz	< 0.03 %	•	Point	2	> 10 mm	< 0.9 ms	analog	4 - 20 mA / 0 - 10 V	< 100 mA	PNP	1	Connector M12 8-pin	OWLF 4060 FA S1							
				-			Line				2.5 - 21				4 - 20 mA	-	-	Connector M12 5-pin	OWLE 5060 AE S1				
	< 0.012 %	Point	2	0 - 10 V		-	-				OWLE 5060 AA S1												
	< 0.04 %	Line	2 - 13	4 - 20 mA / 0 - 10 V		< 100 mA	PNP				2				Connector M12 8-pin	OWLF 4060 FS S1							
	0.015 - 0.8	0.5 - 3.4	250 Hz	< 0.012 %		Line	2 - 17				< 2.5 ms				-	-	-	1	Cable 8-pin, 2 m	OWLF 4060 FS S1 L			
200 - 1000	0.12 - 2.5	0.48 - 10	1100 Hz	< 0.06 %	•	Point	2	> 20 mm	< 0.9 ms	analog	4 - 20 mA / 0 - 10 V	< 100 mA	PNP	1	Connector M12 8-pin	OWLF 4100 FA S1							
				< 0.02 %			Line									2.5 - 35	OWLF 4100 FA S1 L						
	< 0.06 %	Point	2	> 10 mm		< 4 ms	-									-	2	OWLF 4100 FS S1					
	< 0.06 %	Line	2.5 - 20	< 4 ms		OWLF 4100 FS S1 L																	
	0.6 - 2.5	2.4 - 10	100 Hz	< 0.06 %		-	Point									2	-	< 10 ms	RS-485	-	push-pull	1	OWLE 4100 AD S1
	0.12 - 3	0.36 - 9	285 Hz	< 0.04 %		•	Line									2.5 - 35	> 20 mm	< 3.5 ms	-	-	4 - 20 mA / 0 - 10 V	-	PNP
						1 - 25	> 20 mm	< 3.5 ms	-	-	4 - 20 mA / 0 - 10 V	-	PNP	1	Cable 8-pin, 2 m	OWLF 4100 FA K Sp L							

OWLE/F Series / Laser Distance Sensors

Teach-in function

Teaching a new measuring range:

Within 5 minutes after power on the sensor can be taught with the help of the button at the sensor. After the teach-in procedure the 5 minutes begin again.

After 5 minutes the sensor does not react any longer to the button.

1. Press button, the LED turns on, if the sensor can still be taught
2. Press the button for further 5 s until the LED begins to flash
3. Release button
4. Place a target at the position with which the sensor should produce 0 V or 4 mA
5. Press button briefly (as receipt the LED flashes fast), afterwards it continues to flash normally
6. Place a target at the position with which the sensor should produce 10 V or 20 mA
7. Press button briefly (as receipt the LED flashes fast), afterwards it turns of and flashes again briefly. The sensor is now again ready for use.

If one of the two new borders was outside of the measuring range, or the borders are together to cosely, the LED begins to flash fastly. The teach-in procedure was not successful and has to be repeated.

Externe Teach-In Funktion

By the teach-wire the teach-in can be accomplished in equivalent to the manual Teach In. In contrast to the manual function the sensor can be taught always by the teach-wire. For a machine controller the alarm exit can be used to indicate the state of the sensor.

Wiederherstellung des Auslieferungszustands

1. Press button while sensor can be taught (red LED turns on)
2. Press button for 5 s until the LED starts flashing (do not release the button). Wait further 10 s until the LED begins to flash fast. Factory settings have now been restored.
3. Release button (procedure can be carried out by the teachwire also)

Anschlussbilder

OWLE series analog

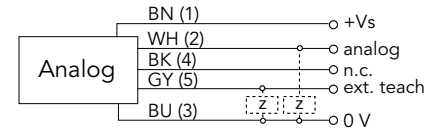

OWLE series RS-485

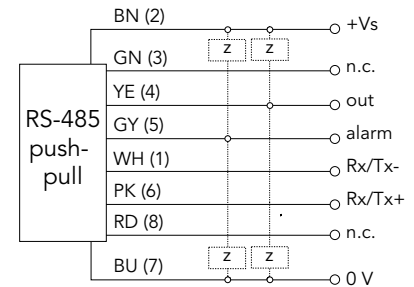

OWLF series analog

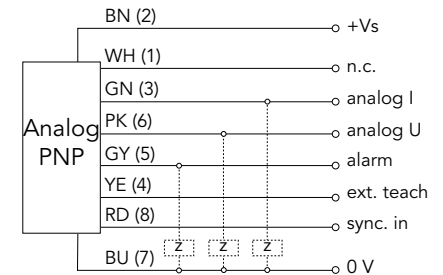

OWLE/F Series / Laser Distance Sensors

Dimensions (mm)

Housingtype 1

20.6 x 65 x 50 mm

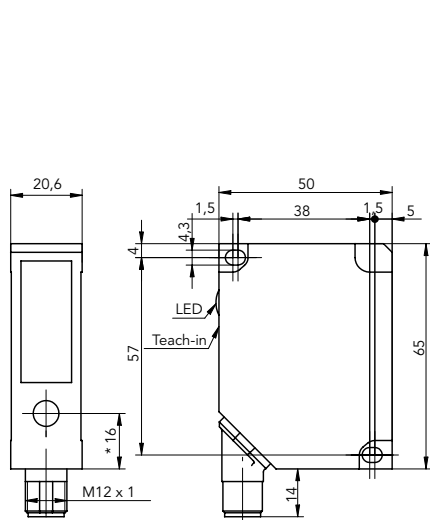

Housingtype 2

20.4 x 135 x 45 mm

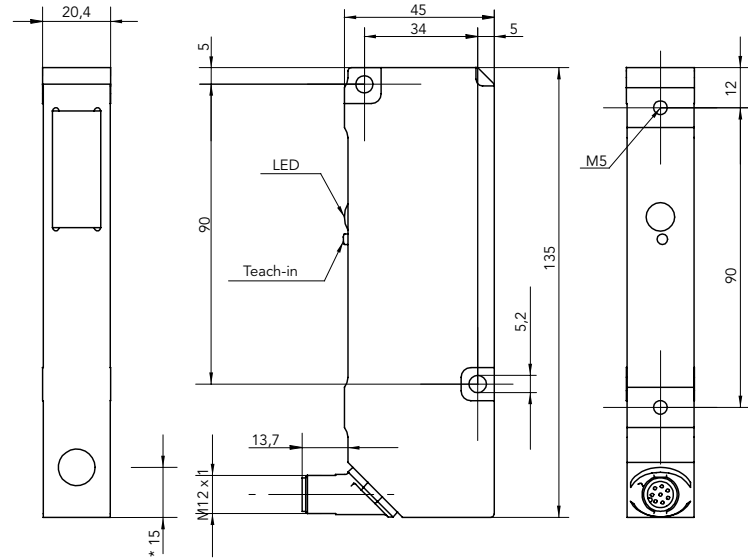

Linearity errors

30 - 50 mm

OWLE 4005 AD S1 / OWLE 4005 AD S1 L

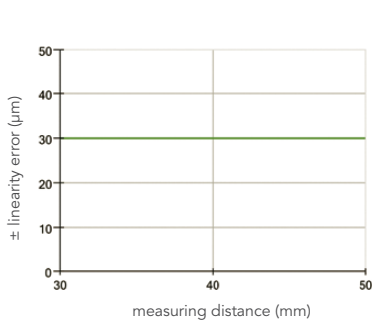

30 - 70 mm

OWLE 5007 AE S1 / OWLE 5007 AA S1 /
OWLF 4007 FA S1 / OWLF 4007 FA S1 L

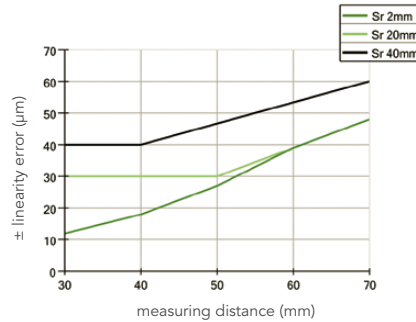

30 - 130 mm

OWLE 5013 AE S1 / OWLE 5013 AA S1 /
OWLF 4013 FA S1 / OWLF 4013 FA S1 L

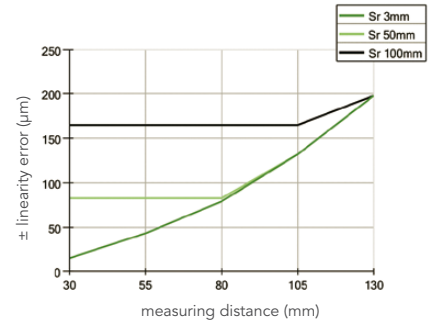

30 - 130 mm

OWLE 4013 AD S1 / OWLE 4013 AD S1 L

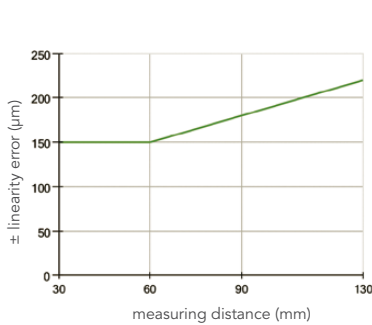

50 - 250 mm

OWLE 4025 AD S1 / OWLE 4025 AD S1 L

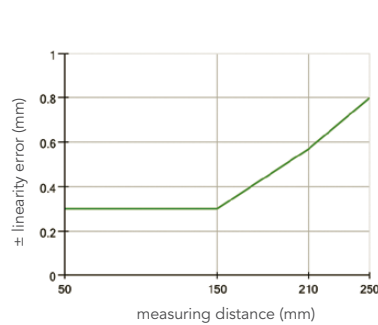

50 - 300 mm

OWLE 5030 AE S1 / OWLE 5030 AA S1 /
OWLF 4030 FA S1 / OWLF 4030 FA S1 L

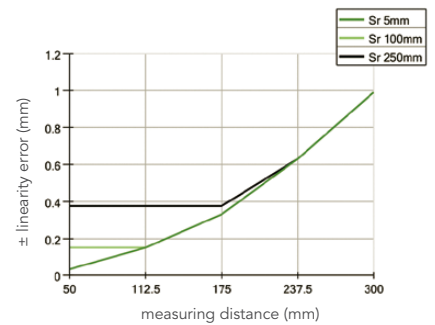

OWLE/F Series / Laser Distance Sensors

Linearity errors

50 - 300 mm

OWLF 4030 FA K Sp L

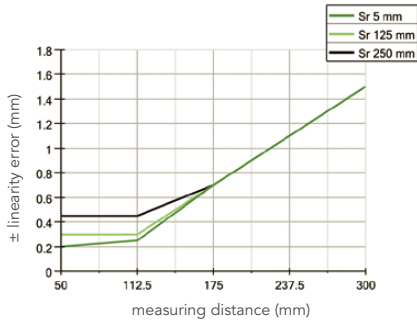

100 - 500 mm

OWLE 4050 AD S1 / OWLE 4050 AD S1 L

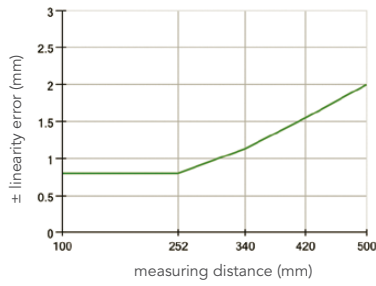

100 - 600 mm

OWLF 4060 FA S1 / OWLF 4060 FA S1 L /
OWLE 5060 AE S1 / OWLE 5060 AA S1

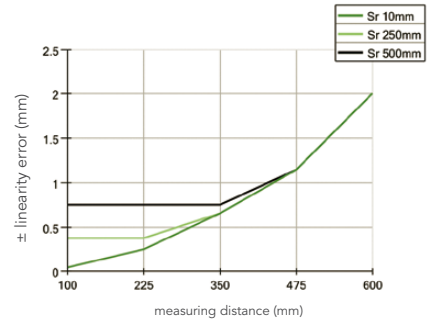

100 - 600 mm

OWLF 4060 FS S1 / OWLF 4060 FS S1 L

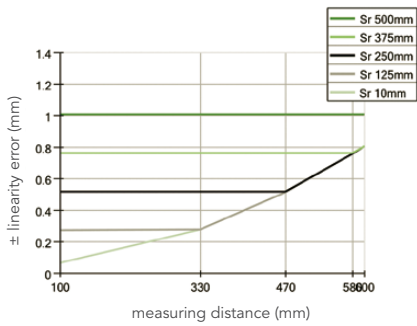

100 - 600 mm

OWLF 4060 FA K Sp L

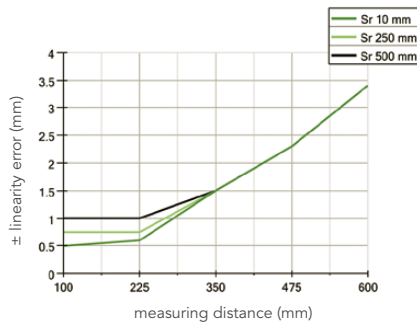

200 - 1000 mm

OWLF 4100 FA S1 / OWLF 4100 FA S1 L

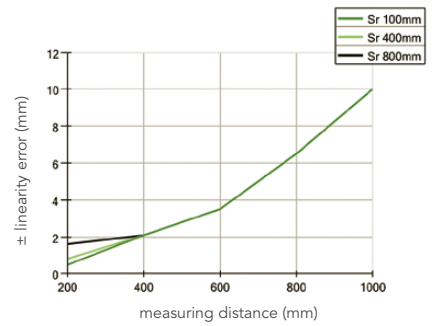

200 - 1000 mm

OWLF 4100 FS S1 / OWLF 4100 FS S1 L

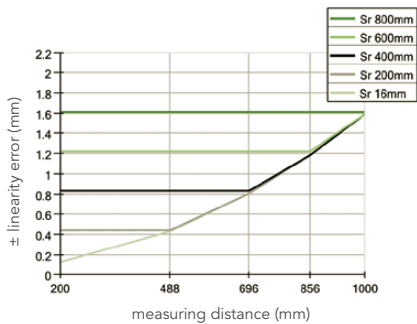

200 - 1000 mm

OWLE 4100 AD S1 / OWLE 4100 AD S1 L

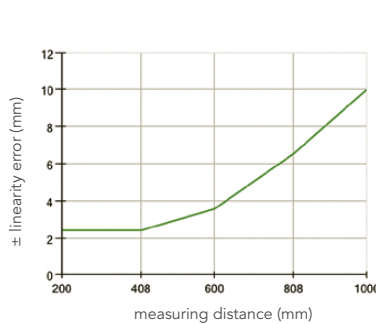

200 - 1000 mm

OWLF 4100 FA K Sp L

