

## HOW TO RECOGNIZE YOUR PART NUMBER

The part numbering systems for single-row tapered roller bearings (type TS) are internationally recognized. Several part number systems have been developed that can be classified according to "metric" or "inch" systems. Within both the metric and inch systems, different part number systems have been developed. Inch system bearings are normally assigned individual part numbers for the inner race and outer races, whereas ISO bearings are assigned a unique part number for the bearing assembly (inner race and outer race).

### BEARING SERIES

In all the part numbering systems the term "bearing series" is used to describe bearings having the same basic internal geometry (e.g. roller size, included inner race and outer race angle). Any inner race (including roller set) can be matched with any outer race within the same series providing that the same type of bearing is being used.

## INCH PART NUMBERING SYSTEMS

### ORIGINAL INCH PART NUMBERING SYSTEM

The original system developed by The Timken Company was based on a family of bearings designed around a common roller. Varying the number of rollers and the angle of the raceways allows different bearings to be designed for predominant radial load (shallow angle) or thrust load (steep angle).

For example, all the tapered roller bearings in the 500 family use the same roller. However, the 595 Series has a steep angle and 24 rollers while the 525 Series has a shallow angle and 15 rollers.

Individual part numbers are assigned to the inner race and outer races. Although there are exceptions, the general rule is that the outer race has a part number that is lower than the series number, whereas the inner race is assigned a higher number.

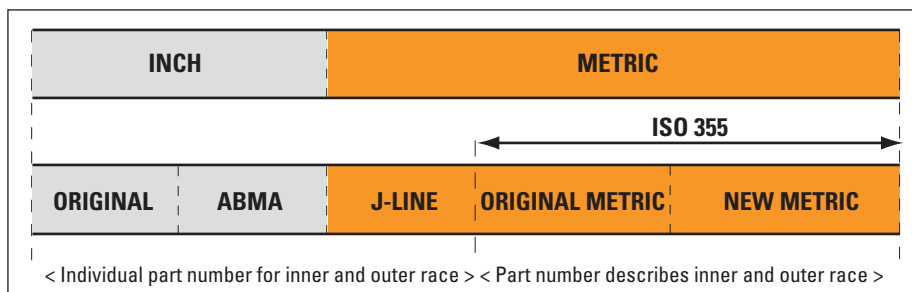

For example:

Series        575  
 Outer race   572  
 Inner race   576

### SYMBOLS

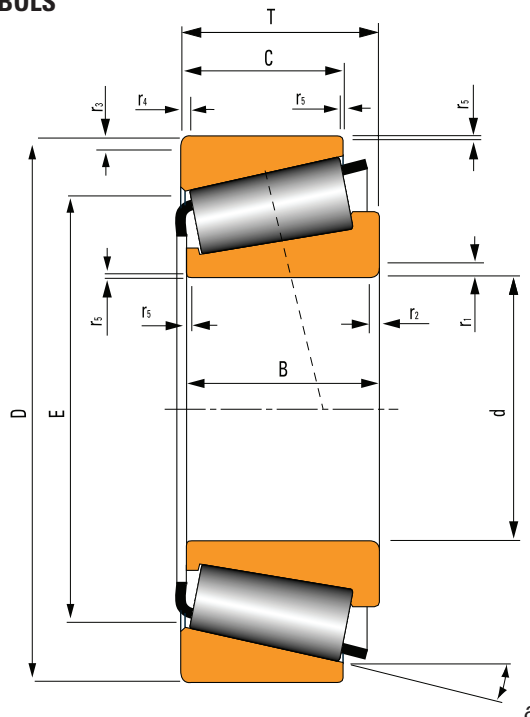

- d = bearing bore diameter
- D = bearing outside diameter
- T = bearing width
- B = inner race width
- C = outer race width
- E = outer race small inside diameter
- a = 1/2 included outer race contact angle
- r1 = inner race back face radius height
- r2 = inner race back face radius width
- r3 = outer race back face radius height
- r4 = outer race back face radius width
- r5 = inner race and outer race front face chamfer height and width



**ABMA INCH PART NUMBERING SYSTEM**

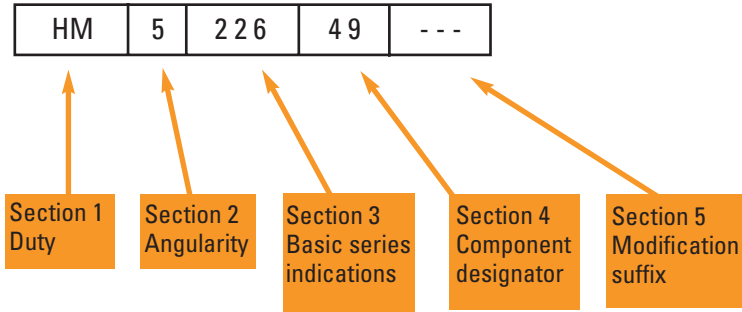

A new inch part numbering system was developed by the American Bearing Manufacturers Association (ABMA) to address the expansion in the number of new applications and tapered roller bearing designs. This part numbering system has become the international standard for inch-sized bearings.

The ABMA part numbering system applies to new bearing series only. Existing part numbers according to the original system, new part numbers that are added to the existing series and proprietary part numbers of special bearings continue to be used.

The new part number is divided into 5 alpha-numeric sections:

**Section 1 - Prefix Letters**

The prefixes will consist of one or two letters and will designate the duty class for which the bearing is designed.

EL	Extra Light	HM	Heavy Medium
LL	Lighter than Light	H	Heavy
L	Light	HH	Heavier than Heavy
LM	Light Medium	EH	Extra Heavy
M	Medium	T	Thrust only

**Section 2 - Angularity Designator**

The first digit following the prefix will represent the angle coding as determined by the included angle of the outer race.

Included Outer race Angle	Code
0	1
24°	2
25° 30'	3
27°	4
28° 30'	5
30° 30'	6
32° 30'	7
36°	8
45°	9
90°	0

**Section 3 - Basic Series Indication**

The 2nd, 3rd, and 4th digits following the prefix letters are reserved for the basic series indication.

The selection of the basic series indication in relation to the maximum theoretical bore of the bearing will then be in accordance with the following tabulation:

Maximum Bore Range (inches)	Series Indication	Maximum Bore Range (inches)	Series Indication
0 - 1	00 to 19 incl.	15 - 16	640 to 659 incl.
1 - 2	20 to 99 incl.	16 - 17	660 to 679 incl.
	000 to 029 incl.	17 - 18	680 to 694 incl.
2 - 3	030 to 129 incl.	18 - 19	695 to 709 incl.
3 - 4	130 to 189 incl.	19 - 20	710 to 724 incl.
4 - 5	190 to 239 incl.	20 - 21	725 to 739 incl.
5 - 6	240 to 289 incl.	21 - 22	740 to 754 incl.
6 - 7	290 to 339 incl.	22 - 23	755 to 769 incl.
7 - 8	340 to 389 incl.	23 - 24	770 to 784 incl.
8 - 9	390 to 429 incl.	24 - 25	785 to 799 incl.
9 - 10	430 to 469 incl.	25 - 30	800 to 829 incl.
10 - 11	470 to 509 incl.	30 - 35	830 to 859 incl.
11 - 12	510 to 549 incl.	35 - 40	860 to 879 incl.
12 - 13	550 to 579 incl.	40 - 50	880 to 889 incl.
13 - 14	580 to 609 incl.	50 - 72.5	890 to 899 incl.
14 - 15	610 to 639 incl.	72.5 and over	900 to 999 incl.

**Section 4 - Component Designator**

The 5th and 6th digits, or the last two digits, following the prefix letters will indicate the actual part number of the bearing component.

Outer race numbers will be indicated by the digits 10 to 19, inclusive, the first outer race made to minimum section in any series starting with the number 10. If more than 10 outer races appear in any series, numbers 20 to 29 will be utilized where available.

Inner race numbers will be indicated by the digits 30 to 49, inclusive, the first inner race made to minimum section in any series being numbered 49.

**Section 5 - Suffix**

This will consist of one letter to three letters in pre-arranged combinations, indicating modifications in external form or internal arrangement.

## PREFIXES AND SUFFIXES

Some of the symbols used by The Timken Company and prefixes and suffixes that are part of the ABMA part numbering standard:

PREFIX	SUFFIX	INNER RACE OR OUTER RACE	EXPLANATION
A		Inner race & Outer race	Standard basic series part number.
A		Inner race	Different radius from basic part number.
A		Inner race	Different bore from basic part number.
A		Inner race	Different complement of rollers.
A		Outer race	Different O.D. from basic part number.
A		Outer race	Different radius from basic part number.
A		Outer race	Different width from basic part number.
AA		Inner race & Outer race	Different bore, O.D., width or radius from basic part number.
AB		Inner race	Different bore, width or radius from basic part number, assembled with brass cage.
AB		Outer race	Flanged outer race. (Non-interchangeable with basic part number.)
AC		Inner race	Different bore or radius, different internal geometry.
AC		Outer race	Different O.D., width or radius from basic part number.
AD		Outer race	Double Outer race. (Non-interchangeable with basic part number.)
ADW		Inner race	Double Inner race. Pilots and slots each end, holes in large rib.
AH		Inner race	Assembled with special cage, rollers, and/or internal geometry
AL		Inner race	Assembled with Duo-Face seal.
ARB		Outer race	Single outer race with snap ring groove in O.D.
AS		Inner race & Outer race	Different bore, O.D., width, or radius from basic part number.
ASB		Inner race	Single inner race, different bore or width from basic part number, assembled with brass cage.
AV		Inner race & Outer race	Made of special steel.
AW		Inner race & Outer race	Keyway or slotted inner race or outer race.
AX		Inner race & Outer race	Different bore, O.D., width, or radius from basic part number.
AXB		Inner race	Different bore, width, or radius from basic part number, assembled with brass cage.
AXD		Outer race	ISO outer race - double outer race without oil holes or groove.
AXV		Inner race & Outer race	Different O.D., width, or radius from basic part number. Made of special steel.
AXX		Inner race & Outer race	Different O.D., width, or radius from basic part number. Made of special steel.
B		Outer race	Flanged outer race. (Non-interchangeable with basic part number.)
B		Inner race	Inner race using brass cage.
B		Inner race & Outer race	ISO bearing with same boundary dimensions as basic part number, but with different internal geometry, steeper included outer race angle.
BA		Outer race	Flanged outer race. (Non-interchangeable with basic part number.)
BNA		Inner race	ISO inner race used in assemblies with 2 inner races mated with double outer race to form a double row non-adjusting bearing. (Non-interchangeable with other inner races having the same basic part numbers, which may vary in bore or width dimensions.)
BR		Outer race	Single outer race with groove in O.D. for snap ring.
BS		Outer race	Flanged outer race. (Non-interchangeable with basic part number.)
BW		Outer race	Flanged outer race with slot. (Non-interchangeable with basic part number.)
BX		Outer race	Flanged Outer race. (Non-interchangeable with basic part number.)
BXX		Outer race	Flanged single outer race. Made of special steel.
C		Inner race	Single inner race, envelope dimensions same as basic part number, different internal geometry.
C		Outer race	Dimensionally different from basic part number. (Non-interchangeable.)
CA		Inner race	Single inner race, envelope dimensions same as basic part number, different internal geometry.
CB		Inner race	Single inner race, dimensionally different from basic part number.
CD		Outer race	Double outer race with oil holes and groove. One hole counter-bored for locking pin.
CE		Outer race	Dimensionally different from basic part number. (Non-interchangeable.)
CN		Outer race	Neoprene cushioned outer race.

B





# ROLLER BEARINGS



B



PREFIX	SUFFIX	INNER RACE OR OUTER RACE	EXPLANATION
CP		Inner race & outer race	Flash chrome plated. Otherwise, interchangeable with basic part number
CP		Inner race & outer race	Envelope dimensions same as basic part number, different internal geometry, customized for performance.
CR		Inner race & outer race	Ribbed outer race bearing series.
CS		Inner race & outer race	Dimensionally different from basic part number. (Non-interchangeable.)
CX		Inner race	Dimensionally different from basic part number. (Non-interchangeable.)
D		Inner race & outer race	Double inner race or Double outer race. (Non-interchangeable with basic part number.)
DA		Inner race	Double inner race. (Non-interchangeable with inner races having same basic part number.)
DA		Outer race	Spherical O.D. double outer race. (Non-interchangeable with basic part number or other double outer races having same basic numbers.)
DB		Outer race	Double outer race with flange. (Non-interchangeable with basic part number or double outer races having same basic numbers.)
DB		Inner race	Double inner race assembled with brass cages.
DC		Outer race	Double outer race with hole for locking pin.
DD		Inner race & outer Race	Special long double inner race or outer race. (Non-interchangeable with basic part number or other double parts having same basic numbers.)
DE		Inner race & outer race	Double inner race or double outer race having different dimensions or other characteristics from single and double parts identified with same basic part number.
DF		Outer race	Double outer race with oil holes and groove. Snap ring groove on O.D..
DG		Inner race	Double inner race with pressure removal groove or helical groove in bore.
DGA		Inner race	Double inner race with pressure removal groove or helical groove in bore. (Non-interchangeable with basic part number.)
DGE		Inner race	Double inner race with pressure removal groove or helical groove in bore. (Non-interchangeable with basic part number.)
DGH		Inner Race	Double inner race with presure removal groove or helical groove in bore and with special cage, rollers, and/or internal geometry.
DGW		Inner race	Double inner race with pressure removal groove or helical groove in bore, and having face slots.
DH		Inner race	Double inner race with special cage, rollers, and/or internal geometry.
DP		Inner race	Double inner race with puller groove.
DR		Outer race	Double outer race for ribbed outer race series. (Non-interchangeable with single and double outer races identified with same basic part number.)
DRB		Outer race	Double outer race with snap ring groove.
DS		Outer race	Crowned O.D. double outer race. (Non-interchangeable with other outer races having same basic part numbers.)
DT		Outer race	Tapered O.D. double outer race. (Non-interchangeable with other outer races having same basic part numbers.)
DV		Inner race & outer race	Double inner race or double outer race made of special steel.
DVH		Inner race	Double inner race, special steel, and/or internal geometry.
DW		Inner race & outer race	Double inner race or double outer race with keyway or slot. (Non-interchangeable with inner races or outer races identified with same basic part numbers.)
DWA		Inner race	Double inner race with one end extended and with oil slots in extended end. (Asymmetrical)
DWH		Inner race	Double inner race with oil slots, assembled with special cage, rollers, and/or internal geometry.
DWV		Inner race & outer race	Double inner race or double outer race with keyway or slot. (Non-interchangeable with inner races or outer races identified with same basic part numbers.) Made of special steel.
DX		Outer race	Adaptor for spherical or straight O.D. outer race.
DX		Outer race	Threaded O.D. double outer race. (Non-interchangeable with outer races identified with same basic part numbers.)
DXX		Inner race & outer race	Double inner race or double outer race made of special steel.
E		Inner race & outer race	Inner races or outer races having special characteristics differing from and non-interchangeable with other inner races or outer races identified with the same

PREFIX	SUFFIX	INNER RACE OR OUTER RACE	EXPLANATION
			basic part numbers.
ED		Outer race	Double outer races. (Non-interchangeable with other outer races identified with same basic part numbers.)
EDC			Outer race Double outer races, special hole in O.D. for locking pin.
EE		Inner race	Large and small ribs - close guided rollers. (Non-interchangeable with other inner races identified with same basic part numbers.)
EH		Inner race & outer race	Extra heavy series.
EL		Inner race & Outer race	Extra light series.
EX		Inner race & outer race	Experimental.
	EXX	Inner race & outer race	Inner races or outer races having special characteristics differing from and non-interchangeable with other inner races or outer races identified with the same basic part numbers. Made of special steel.
	F	Inner race	Assembled with polymer cage.
FL		Inner race & outer race	'Free lateral' series, no large or small ribs.
FX		Inner race & outer race	Factory identification number only.
	G	Inner race	Retainer groove in bore.
H		Inner race & outer race	Heavy series. (Non-interchangeable with other inner races and outer races identified with same basic part numbers.)
	H	Inner race	Assembled with special cage, rollers, and/or internal geometry.
	HV	Inner race	Assembled with special cage, rollers, and/or internal geometry. Made of special steel.
	HH	Inner race & Outer race	Heavy-Heavy series. (Non-interchangeable with other inner races and outer races identified with same basic part numbers.)
HM		Inner race & outer race	Heavy-Medium series. (Non-interchangeable with other inner races outer races identified with same basic part numbers.)
	HP	Inner race	Assembled with special cage and/or roller, different internal geometry. Customized for performance.
	HR	Outer race	Special outer race used in 'Hydra-Rib' bearing.
J		Inner race & outer race	Used alone or with other prefix letters to indicate metric bore and/or O.D..
JC		Inner race & outer race	Metric Series.
JD		Inner race & outer race	Metric Series.
JE		Inner race & outer race	Metric Series.
JF		Inner race & outer race	Metric Series.
JG		Inner race & outer race	Metric Series.
JN		Inner race & outer race	Metric Series.
JP		Inner race & outer race	Metric Series.
JR		Inner race & outer race	Metric Series.
JRM		Inner race & outer race	Metric Series, UNIPAC bearing.
JS		Inner race & outer race	Metric Series.
JT		Inner race & outer race	Metric Series.
JU		Inner race & outer race	Metric Series.
JW		Inner race & outer race	Metric Series.
K		Outer race	Double outer race with heavy section. May have unusual features such as flange, tapered O.D., etc.
K		Inner race & outer race	Through hardened components, Non-DIN 720 Part Numbers
K		Miscellaneous	K prefix with 5 or 6 digits following also used for miscellaneous components (seals, bolts, filler rings, etc.)
	KP	Thrust Bearing	Cadmium plated.
L		Inner race & outer race	Light series. (Non-interchangeable with other inner races and outer races identified with same basic part numbers.)
	L	Inner race	Inner race assembled with Duo-Face seal.
	L	Outer race	Loose rib. (Part of Unit-Bearing.)

B





# ROLLER BEARINGS



B



PREFIX	SUFFIX	INNER RACE OR OUTER RACE	EXPLANATION
	LA	Inner race	Inner race assembled with Duo-Face-Plus seal.
	LA, LB, LC, etc.	Seal	These suffixes are used on a basic Duo-Face-Plus seal number to identify the assembly resulting from the use of the seal with various inner races in the series.
	LL	Inner race & outer race	Light-Light series.
	LM	Inner race & outer race	Light-Medium series.
	M	Inner race & outer race	Medium series.
	M	Inner race & outer race	Through hardened components, DIN 720 Part Numbers, IsoClass Part Numbers
	N	Inner race	Bock or Gilliam type bearings.
	NA	Inner race	Two inner races mated with double outer race to form double row non-adjustable bearing. (Non-interchangeable with other inner races having same basic part numbers which may vary in bore, O.D., and width dimensions.)
	NA	Outer race	Etched electric pencil on double outer races mated with two 'NA' type single inner races to form double row non-adjustable bearings.
	NAV	Inner race	'NA' inner race made of special steel.
	NC	Outer race	Cushioned outer race (usually neoprene.)
	NI	Inner race	Tapered or threaded bore.
	NP	Inner race & outer race	Used with random numbers for product differentiation.
	NR	Inner race	'NA' type ribless inner race for ribbed outer race series.
	NW	Inner race	'NA' type inner race with slotted front face.
	NWV	Inner race	'NA' type inner race with slotted front face. Made of special steel.
	NX	Inner race	Lapped front face.
	P	Inner race	Puller groove.
	P	Inner race & outer race	Customized for performance.
	R	Inner race & outer race	Gilliam replacement series. (Non-interchangeable with other inner races and outer races identified with same basic numbers.)
	R	Inner race & outer race	Special feature bearing. (Non-interchangeable with bearings having the same basic part numbers.)
	R	Inner race & outer race	Bock type bearing.
	R	Inner race	Basic part number with polymer lubricant.
	RB	Outer race	Snap ring on O.D.
	RC	Inner race & outer race	Special ribbed outer race bearing.
	RN	Various	Used with random numbers, not to exceed six (6) digits, for purchased items that are distributed by Timken.
	RR	Inner race & outer race	'Relieved race.'
	S	Inner race & outer race	Special feature bearing. (Non-interchangeable with bearings having same basic part numbers.)
	SA	Inner race & outer race	Special feature bearing. (Non-interchangeable with bearings having same basic part numbers.)
	SB	Inner race	Assembled with brass cage.
	SB	Outer race	Flanged outer race.
	SC	Inner race	With square bore.
	SD	Inner race & outer race	Double inner race with square bore or double outer race.
	SH	Inner race	Special feature bearing, with special cage, rollers, and/or internal geometry. (Non-interchangeable with bearings having same basic part numbers.)
	SL	Thrust bearing	Basic part number with polymer lubricant.
	SR	Inner race	Different radius from basic part numbers.
	SW	Inner race & outer race	Slot or keyway. (Non-interchangeable with bearings having same basic part numbers.)
	SWB	Inner race	Slot or keyway assembled with brass cage. (Non-interchangeable with bearings having same basic part numbers.)
	SWV	Inner race	Slot or keyway made of special steel. (Non-interchangeable with bearings having same basic part numbers.)

PREFIX	SUFFIX	INNER RACE OR OUTER RACE	EXPLANATION
	SX	Outer race	Special feature bearing. (Non-interchangeable with bearings having same basic part numbers.)
T		Race	Thrust bearing assemblies.
T		Outer race	Double outer race with heavy section. May have unusual feature such as flange, tapered O.D., etc.
T		Inner race	Tapered bore.
T		Outer race	Tapered O.D.
TA		Inner race	Tapered bore 'NA' type inner race.
TA		Outer race	Tapered O.D.
TB		Inner race	Tapered bore inner race with brass cage.
TC		Race	Thrust bearing assembly.
TC		Inner race	Tapered bore.
TD		Inner race	Double with tapered bore.
TDB		Inner race	Double with tapered bore, assembled with brass cages.
TDE		Inner race	Double with tapered bore and extended rib.
TDG		Inner race	Double with tapered bore, pressure removal groove or spiral groove in bore.
TDGV		Inner race	Double with tapered bore, pressure removal groove or spiral groove in bore. Made of special steel.
TDH		Inner race	Double with tapered bore, special cage, rollers or internal geometry.
TDL		Inner race	Double with tapered bore, interlock feature.
TDV		Inner race	Double with tapered bore. Made of special steel.
TDW		Inner race	Double with tapered bore and slots or keys.
TDXX		Inner race	Double with tapered bore. Made of special steel.
TE		Inner race	Single, tapered bore, extended large rib.
TEV		Inner race	Single, tapered bore, extended large rib. Made of special steel.
TL		Inner race	Tapered bore with interlock feature.
TLE		Inner race	Tapered bore with interlock feature and extended rib.
TP		Inner race	Tapered bore inner race with puller groove.
TPE		Inner race	Tapered bore inner race with puller groove, extended inner race large rib.
TV		Inner race & outer race	Tapered bore inner race or outer race O.D. Made of special steel.
TW		Inner race & outer race	Tapered bore inner race or outer race O.D. with slots or keys.
TWE		Inner race & outer race	Tapered bore inner race or outer race O.D. with locking keyway in front face, extended inner race large rib or outer race width.
TXX		Inner race	Tapered bore. Made of special steel.
U		Inner race & outer race	Basic series part number, unitized, self-contained.
U		Inner race & outer race	Basic series part number, unitized, self-contained.
US		Inner race & outer race	Special close stand.
V		Inner race & outer race	Special close stand.
V		Inner race & outer race	Made of special steel.
VC		Inner race	Special internal geometry. Made of special steel.
VH		Inner race	Special cage, rollers, and/or internal geometry. Made of special steel.
W		Inner race & outer race	Slot(s) or keyway(s).
W		Thrust Bearing	Oil holes in retainer.
WA		Inner race & outer race	Slot(s) or keyway(s).
WB		Inner race	Slot(s) or keyway(s) with brass cage.
WC		Inner race & outer race	Slot(s) or keyway(s).
WD		Inner race & outer race	Double inner race or outer race with slot(s) or keyway(s).
WE		Inner race & outer race	Extended face with slot(s) or keyway(s).
WS		Inner race & outer race	Slot(s) or keyway(s).
WV		Inner race & Outer race	Slot(s) or keyway(s). Made of special steel.

B





# ROLLER BEARINGS



PREFIX	SUFFIX	INNER RACE OR OUTER RACE	EXPLANATION
	WXX	Inner race & Outer race	Slot(s) or keyway(s). Made of special steel.
X		Inner race	ISO part number.
	X	Inner race	Slot(s) or keyway(s).
	X	Inner race & Outer race	Special feature bearing. (Non-interchangeable with bearings having the same basic part number.)
	X	Inner race & Outer race	ISO bearing with same boundary dimensions as basic part number but with different internal geometry, yielding increased rating.
	XA	Inner race & Outer race	Special feature bearing. (Non-interchangeable with bearings having the same basic part number.)
	XAA	Inner race	ISO single inner race. (Non-interchangeable with bearings having the same basic part number.)
	XAB	Inner race	ISO single inner race. (Non-interchangeable with bearings having the same basic part number.)
	XB	Inner race	Different bore, width, or radius, from basic part number. Assembled with brass cage.
	XB	Outer race	Special feature flanged outer race. (Non-interchangeable with bearings having the same basic part number.)
	XC	Inner race & Outer race	Limited production bearings to which standard series part numbers have not been assigned.
	XD	Outer race	Double outer race, no oil holes or groove.
	XD	Inner race	Double inner race, different bore or width from basic part numbers.
	XD	Inner race	Double inner race, oil holes in large rib.
	XDXP	Outer race	Double outer race, no oil holes or groove, special material and process.
	XE	Outer race	Different bore, width, or radius from basic part number.
	XGA	Inner race	ISO single inner race. (Non-interchangeable with bearings having the same basic part number.)
	XGB	Inner race	ISO single inner race. (Non-interchangeable with bearings having the same basic part number.)
	XP	Inner race	Special steel and process.
	XR	Inner race & Outer race	Crossed roller bearings.
	XS	Inner race & Outer race	Different bore, O.D., width, or radius from basic part number.
	XV	Inner race & Outer race	Special feature inner race or outer race made of special steel.
	XW	Inner race	Slotted.
	XX	Inner race & Outer race	Single inner race or single outer race. Made of special steel.
	Y	Outer race	ISO part number.
	YD	Outer race	Double outer race with oil holes, no groove.
	YDA	Outer race	Double outer race with oil holes, no groove. (Non-interchangeable with bearings having the same basic part number.)
	YDV	Outer race	Double outer race with oil holes, no groove. made of special steel.
	YDW	Inner race	Double outer race with oil holes, no groove. Slot(s) or keyway(s) in face(s).
	YKA	Outer race	ISO single outer race. (Non-interchangeable with bearings having the same basic part number.)
	YKB	Outer race	ISO single outer race. (Non-interchangeable with bearings having the same basic part number.)
	YSA	Outer race	ISO single outer race. (Non-interchangeable with bearings having the same basic part number.)
	Z	Inner race & Outer race	Close stand part.



## METRIC PART NUMBERING SYSTEMS

### J-LINE PART NUMBERS

The "J" prefix letter is used in conjunction with the ABMA part numbering system to identify metric dimensioned and toleranced inner race and outer races. The bearing series designation does not contain the prefix letter "J". J-Line bearings are referred to as inch bearings in metric bore, O.D. and width.

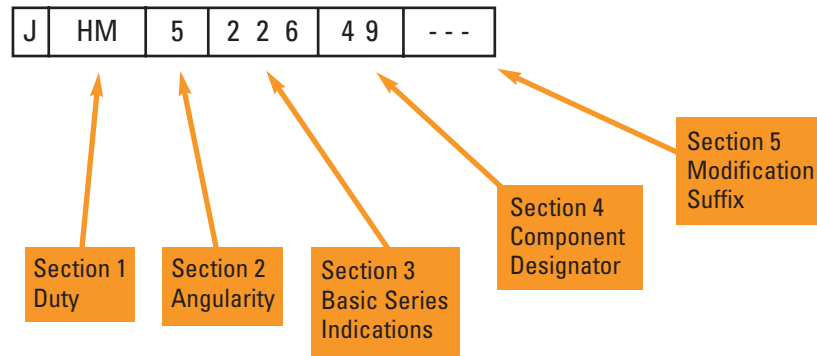

### ISO PART NUMBERING SYSTEM

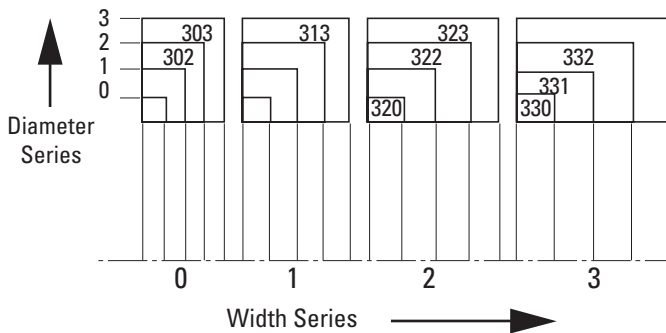

The original metric part numbering system for tapered roller bearings was based on the ISO 15 dimensional plan for radial bearings. A 5-digit part number commencing with numeral 3 describes the bearing assembly (inner race and outer races).

32218 has a 90 mm bore. If the bore diameter is less than 20 mm, the last two digits can be interpreted as follows: 00=10 mm, 01=12 mm, 02=15 mm and 03=17 mm. If the bore diameter is greater than 500 mm, then the last 3 digits (preceded by a slash) correspond to the bore size.

#### Section 1 - Symbol for bearing type

3 always applies to tapered roller bearings.

#### Section 2 - Width series

The bearing width is classified from 0 to 3 in increasing order of width.

#### Section 3 - Diameter series

The bearing section height is classified from 0 through 3 in increasing order of O.D. for a given bore size.

#### Section 4 - Inner race bore designation

The 2 last digits relate to the inner race bore diameter that can be calculated by multiplying the number indicated by 5, if the bore diameter is between 20 and 500 mm. For example, bearing

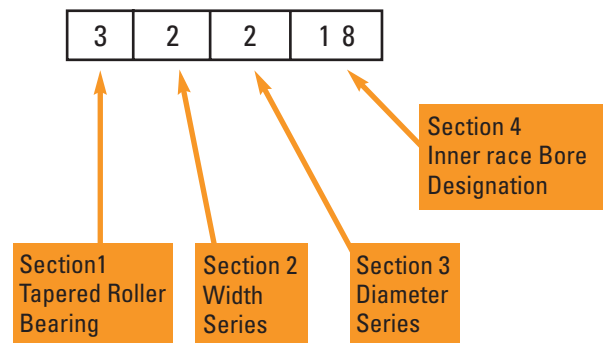



**NEW ISO 355 PART NUMBERING SYSTEM**

Finding that tapered roller bearings did not conform to the ISO 15 general plan, because dimensions given were not found to be optimal, the ISO introduced a new numbering system for tapered roller bearings in ISO 355. This system uses 3 alpha-numeric fields to define the bearing series. The bearing part number is then

defined by adding the inner race diameter in mm after the bearing series. Although all original metric part numbers were assigned a new designation in the ISO 355 plan, the original part number is still used.

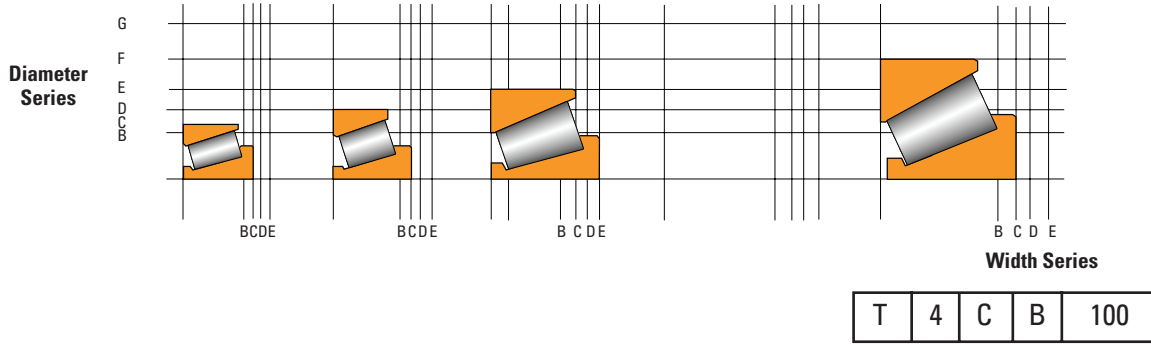

Symbol for tapered roller bearings (optional)

Angle Series Designation	a	
	over	incl.
1	Reserved for future use	
2	10°	13° 52'
3	13° 52'	15° 59'
4	15° 59'	18° 55'
5	18° 55'	23°
6	23°	27°
7	27°	30°

Diameter Series Designation	$\frac{D}{d}^{0.77}$	
	over	incl.
A	Reserved for future use	
B	3.40	3.80
C	3.80	4.40
D	4.40	4.70
E	4.70	5.00
F	5.00	5.60
G	5.60	7.00

Width Series Designation	$\frac{T}{(D - d)^{0.95}}$	
	over	incl.
A	Reserved for future use	
B	0.50	0.68
C	0.68	0.80
D	0.80	0.88
E	0.88	1.00

Bearing bore diameter (mm)



**“NEW” METRIC BEARINGS**

A new range of metric bearings were also included in the ISO 355 plan. These new bearings are specifically application-oriented and are designed for optimum performance.

To easily identify these part numbers against the application type, The Timken Company introduced an alpha-numeric part number designation. The part number construction is similar to that of J-Line part numbers and separate numbers are assigned to both inner race and outer races.

**J-prefix**

All of the new metric bearings are identified with a J-prefix that indicates a new metric dimensioned and toleranced bearing.

**Section 1 - Duty**

Indicates application type:

C, D & F = general purpose

N = combination of general purpose and pinion

P = high speed

S and T = pinions

W = high axial loads

**COMPARISON TABLE: INCREASE IN SECTION FOR A 55 MM BORE BEARING**

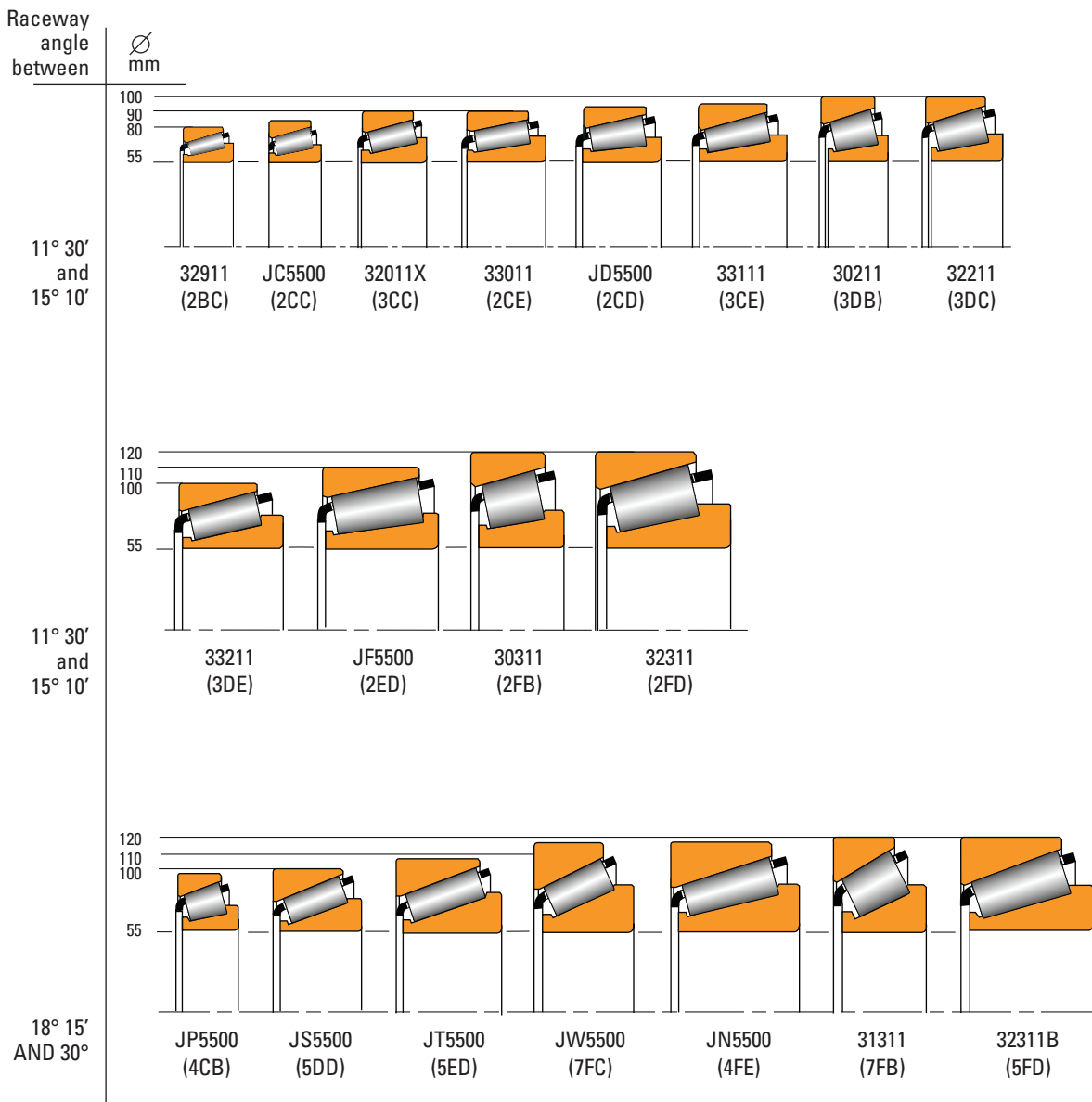



# ROLLER BEARINGS

## Section 2 - Inner race Bore

The inner race bore metric diameter is included in the part number designation of both the inner race and outer races.

## Section 3 - Component Designator

Same identification as in the ABMA part numbering system.

For further explanation of prefix and suffix symbols, or proprietary part numbers of special bearings, consult your Timken sales representative.

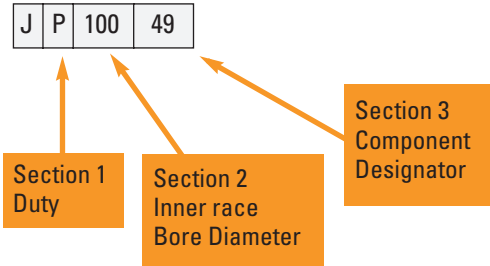

## OPTIMUM BEARING SELECTION: ISO 355

ISO 355 offers many application-specific bearing selection options for a given bore. Depending on application and type of load, thrust and/or radial, the bearing with the optimum angle and section can be selected. For example, pinion bearings have a steep angle, whereas bearings for machine tools are generally designed with a shallow angle and a light-section. The previous table demonstrates this feature for 55 mm bore bearings.

## BEARING ASSEMBLY NUMBERS

Multiple-row bearings and matched bearing assemblies are assigned a 5-digit alpha-numeric code, in combination with the inner race part number to describe the individual component parts, inspection level and the adjustment value of pre-set assemblies: e.g., LM48548-9K2A7.

An assembly number is assigned on receipt of the first order for new applications. It is very important for correct function of the bearing in a given application that the same assembly number is quoted for all subsequent orders. The Timken Company should be consulted if additional information is required on the assembly number.

## Radial Tapered Roller Bearings - Torrington

Two or three-digit size indication. The number is read as an actual bore (i.e., 70 is 7.0 in.) or approximate bore i.e., 83 is 8.375 in.).

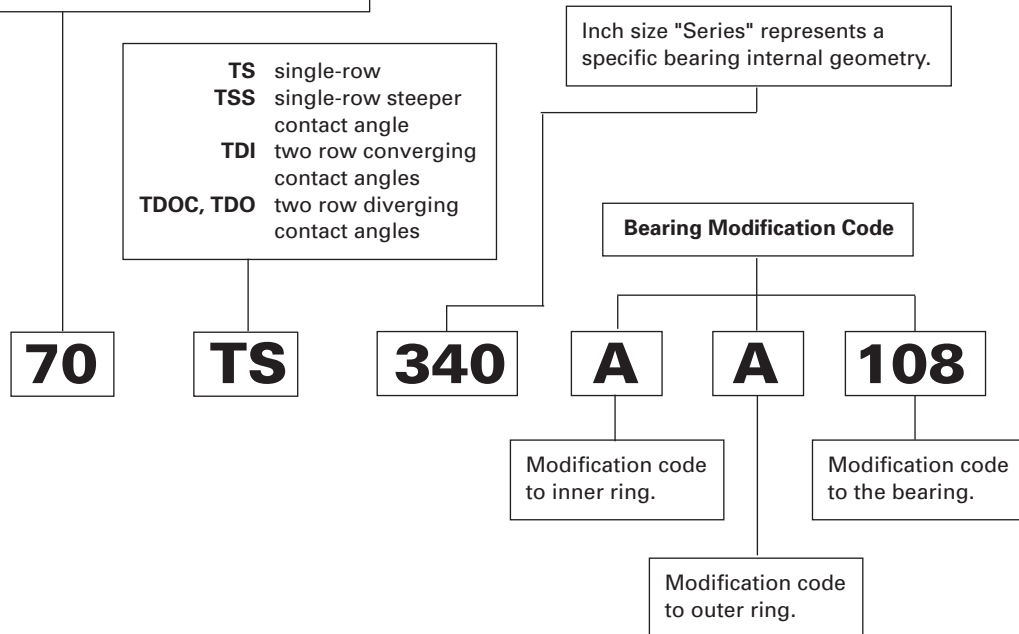



# TS

## TAPERED ROLLER BEARINGS

- TS style is the most widely used tapered roller bearing.
- Part numbers give specifiers the widest possible choice from the comprehensive range of metric (ISO and 'J' prefix) and inch-sizes available from The Timken Company.
- Consult your Timken representative before making a final bearing selection to ensure suitability, availability and the most cost-effective application.
- To place an order or obtain a quotation, specify the inner and outer part numbers.

Example:       inner race                  outer race  
                                       **JH211749 - JH211710**

- In most ISO bearings, only one bearing number is specified for both races:

Example:                                  **32310**

Conforms to the ISO 355 standard.

### BEARING DATA TABLES

In the following bearing data tables, part numbers are listed in ascending order of bore, outside diameter and width.

Bearing ratings shown in tables are based on environmental reference conditions. Effects of known operating conditions on bearing performance in an application should be investigated before final bearing selection is made.

Approximate mass is listed for every part number. For weight-critical applications or exact freight cost evaluation purposes, a more accurate value should be obtained from your Timken representative.

