



# UniTrane™ Harmony

## Cabinet fan coil

Models with AC fan motor - FCAS-FKAS-FVAS

Sizes 11-12-21-22-31-32-33-34-41-42-43-44-51-52-61-62-63-64

Models with EC fan motor - FCAE-FKAE-FVAE

Sizes 21-22-33-34-43-44-51-52-63-64

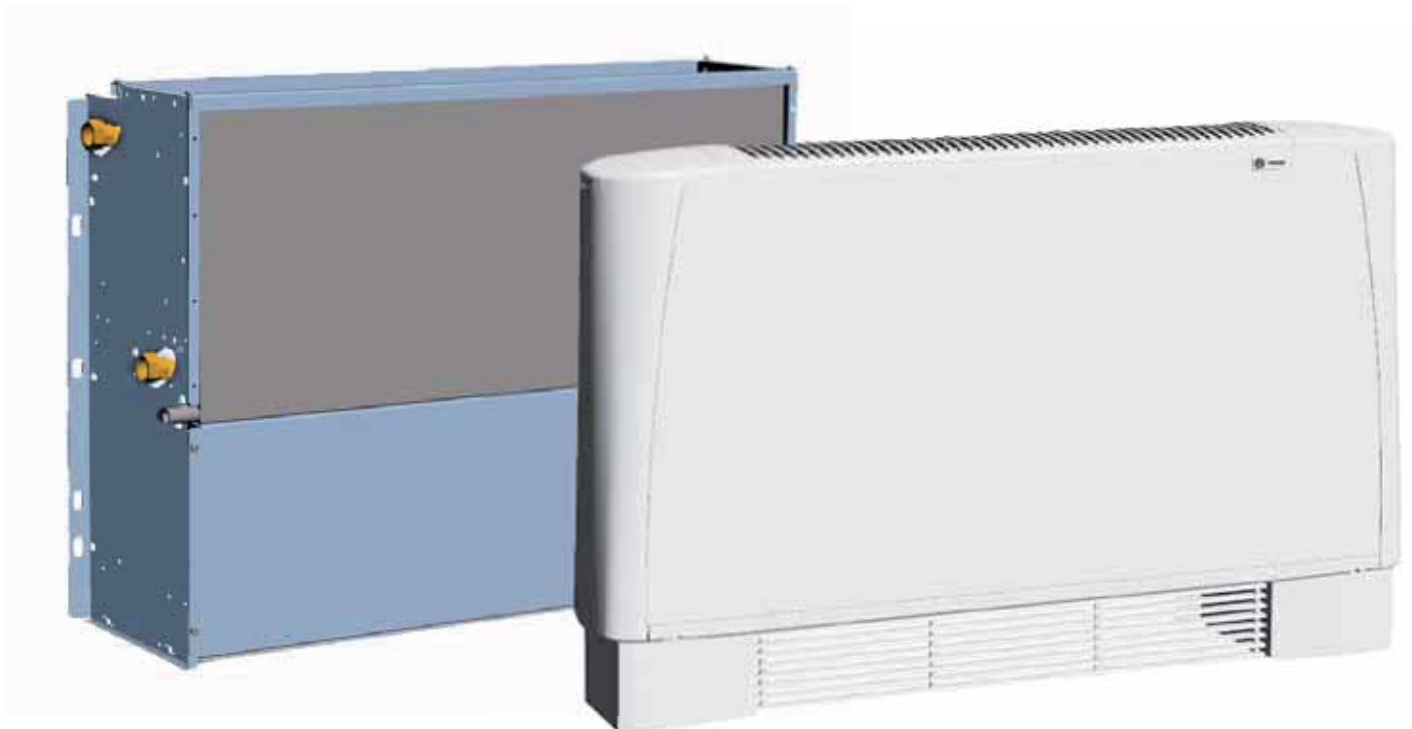

UNT-PRC020-E4



## Contents

---

<b>Introduction</b>	<b>3</b>
<b>Model number</b>	<b>6</b>
<b>Dimensions and weights</b>	<b>7</b>
<b>General data</b>	<b>9</b>
<b>Performance data</b>	<b>11</b>
<b>Sound data</b>	<b>30</b>
<b>Factory-installed options</b>	<b>32</b>
<b>Standalone controls</b>	<b>36</b>
<b>Group controls</b>	<b>41</b>
<b>Building Management Controls</b>	<b>45</b>
<b>Accessories (Field installed)</b>	<b>46</b>

# Introduction

---

The UniTrane™ Harmony fan coil is specifically designed for office, hotel and healthcare applications where low sound level is a critical parameter.

The unit design allows for vertical installation on the floor or attached to a wall, and also horizontal installation on the ceiling. Conversion from one to the other consists in simply changing the position of the external drain pan.

The fan coil is available in 3 main configurations:

**Concealed version (FKAS,FKAE)** - when unit is installed into a wall housing or false ceiling.

**Cabinet with front return version (FCAS,FCAE)** - when unit height limit is a critical criteria.

**Cabinet with in-line return version (FVAS,FVAE)** - when air circulation is important. This version is available with factory-mounted feet and grille as an option.

The range includes:

**2-pipe cooling only**

**2-pipe cooling and heating**

**4-pipe coil** – with a choice of standard hot water coil and enhanced capacity water coil when a higher heating capacity is required.

## Indoor Air Quality

High indoor air quality requirements are covered thanks to the Trane CleanEffects™ electrostatic air filter. The main advantage of this technology is to catch very fine particles with an electrostatic field. The result is an air purified from airborne allergens such as pollens, cigarette smoke and bacteria. The CleanEffects™ technology advantage is also ecological: The air pressure drop of this filter is very low and remains constant in time resulting in reduced fan power consumption.

The purifying effect results in a reduced need of fresh air introduction and energy consumption linked to fresh air treatment.

The filter media is simple to clean with water and is reusable without changing the media.

## Factory-installed options

In order to optimize installation simplicity and cost, the unit is available with factory-mounted options. They are all

factory-tested, ensuring high quality, reliability and quick commissioning.

Factory-mounted options are:

- Left hand / right hand valves installation
- Standard / High fan speed setup
- G0 / G3 air filters
- CleanEffects™ electrostatic air filter
- Electric Heater Low / Medium / High capacity
- Trane Tracer™ ZN unit control
- Modbus group unit control
- Unit mounted thermostat or controller interface
- 2-way or 3-way water valves
- Micrometric / shut off valve
- Condensate drain pan
- Condensate pump
- Unit support feet + return air grille

## Controls

The unit control is proposed with three levels of complexity:

- Standalone
- Group control
- Building Management System applications

An infrared remote controller mounted on site is available for group control of up to 20 units.

A wall-mounted thermostat with LCD display is also available for group control of up to 60 units.

## Main components

### Cabinet

The cabinet casing is made with a combination of high quality resilient plastic and robust metal panels. The outlet is made in a one piece grille that can be unclipped and reversed to invert direction of the air stream from front to back. The result of this combination of material is an aesthetic, long lasting robust unit cabinet assembly.

The cabinet color is RAL9003 white satin finish.

Inside the unit, the galvanized steel sheet metal is insulated with closed cell insulation to ensure proper thermal break.



# Introduction

---

## Filters

The unit is offered with 3 types of filters easily accessible through sliding guides on the return opening:

- EU0 (G0) plastic filter that is easy to regenerate by simple water cleaning. The EU0 filter choice combines a low air pressure drop and low cost of maintenance provided by its capability to be cleaned.
- EU3 (G3) filter is made of polyester media supported on steel wire frame. The EU3 is a solution when medium filtration and A2 fire class is required.
- CleanEffects electrostatic filter is an “active” filtering system. Prior to enter into the electrostatic filter, the air is cleaned from big particle (>50 microns) with a classic pre-filter. The remaining fine particles (<50 microns) enter into an electrostatic field and leave it positively charged. Then the particles are caught by electrostatic attraction to a negatively charged surface.
  - The result is an extremely efficient filter (better than EU9) with low air pressure drop.
  - The filter is easy to clean. Plastic media used to catch particles is removable and can be regenerated by washing with water and ordinary detergents or steam cleaning devices.
  - The CleanEffects filter is controlled by electronic board ensuring safe protection and proper operation of the electrodes. The energy consumption of the CleanEffects filter is limited to 15W for the biggest unit. Operation can be switched ON or OFF by a thermostat.

## Fan

The fan wheel profile is made in aluminum or plastic, double inlet and directly driven by the motor. The fan and motor assembly is statically and dynamically balanced to ensure quiet operation.

## Electric motor

The fan motor is available with 2 technologies:

### **AC fan motor technology (FKAS, FVAS, FCAS)**

AC fan motor is designed with 6 equidistant speeds of which 3 are connected providing

good flexibility to best suit the airflow and capacity needs. The motor is made with life lubricated bearings and is supported on anti-vibration grommet.

An internal thermal protection with automatic reset ensures motor overload protection.

The motor protection is IP 20, insulation is class B.

The speed setting is factory-configured with standard speed set or upper speed selection delivering more flexibility on airflow, capacity and noise.

### **EC fan motor technology (FKAE, FVAE, FCAE)**

Fans represent a major part of energy consumption in air conditioning systems; EC motor defined as a brushless direct current commutation of motor windings by means of electronic controls. It has a full load efficiency above 80% which is twice the one of a standard AC motor and thus throughout the operating range. Overall, EC motor draws an average of 4 times less in watt, providing up to 67% reduction to the annual electricity bills on the terminals.

The motor is made of a 3 phase permanent magnet motor controlled via an inverter board suitable for power supply single phase 230-240 V, 50 and 60 Hz. It is thermal protected and as a protection class B and IP20.

# Introduction

Typical fan motor loads of an office building in Paris

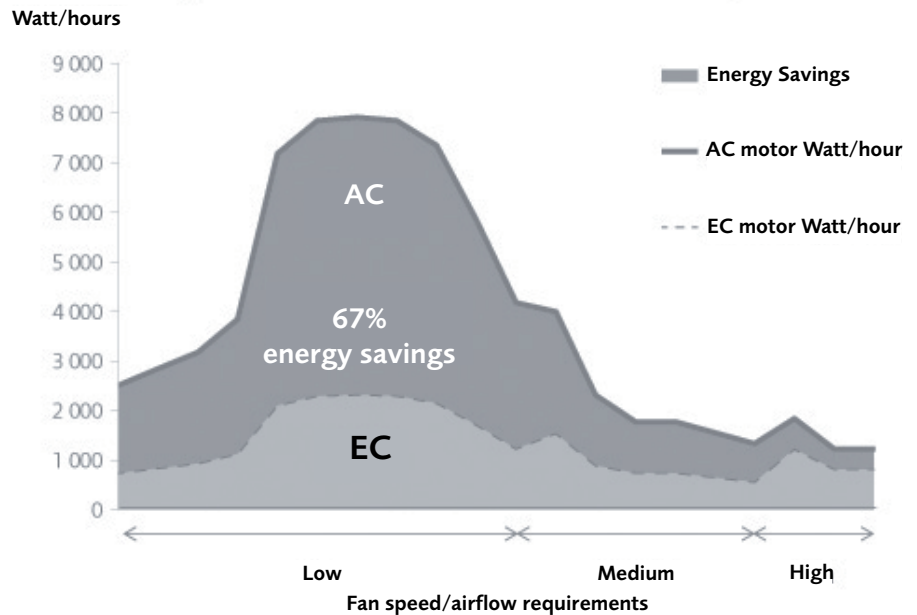

## Coil

The coil is made with aluminum fins mechanically bonded onto a copper tube. The coils are all provided with 1/2" ISO R7 threaded connection. And 1/8" air vent and drain purge.

The maximum operating pressure is 10 bar or 1000 kPa.

The aluminum of the fins is not coated, so the coil is only designed for classic comfort application in a non-corrosive environment.

Water connections are located at the opposite side of the control panel. The side of the coil connection (and water valves) has to be considered facing the airflow. The unit can be converted from left hand to right hand easily on jobsite if needed.

## Condensate drain pan

The condensate drain pan is made of ABS plastic with 3 mm polyethylene foam external insulation such providing no risk of corrosion. It is easily washable. For units with an electric heater, the condensate tray is made of 1 mm-thick painted galvanized steel with 3 mm of polyethylene insulation.



## Model number

---

### Digit 1 - Product family

F = Fan coil

### Digit 2 - Return air side

C = Front return

V = Vertical return

K = Concealed vertical return

### Digit 3 - Major design sequence

A = Design sequence A

### Digit 4 - Fan motor type

S = AC Fan motor

E = EC Fan motor

### Digit 5 - Unit casing size

1 = Casing 1

2 = Casing 2

3 = Casing 3

4 = Casing 4

5 = Casing 5

6 = Casing 6

### Digit 6 - Coil and fan motor size

1 = Coil/Fan 1

2 = Coil/Fan 2

3 = Coil/Fan 3

4 = Coil/Fan 4

### Digit 7 - Minor Design Sequence

\* = Factory assigned Minor design sequence

### Digit 8 - Application type

A = 2 pipes Cooling-only

C = 2 pipes cooling & heating

D = 4 pipes

### Digit 9 - Heating coil size

X = Standard / Without heating coil

2 = Enhanced capacity

### Digit 10 - Water connection side and control box (facing the airflow)

L = Water : Left, Control box : Right

R = Water : Right, Control box : Left

### Digit 11 - Fan speed selection (AC fan motor)

1 = Standard speed setup

2 = High speed setup

### Digit 12 - Filter type

X = Standard G0 filter

3 = EU3 filter

Q = CleanEffects™ electrostatic air filter (IAQ)

### Digit 13 - Electric heater

W = Without

L = Low capacity

M = Medium capacity

H = High capacity

### Digit 14 - Unit controller type

W = Without (Terminal block only for wall or onboard thermostat)

A = Modbus controller

B = Trane Tracer™ ZN zone control

C = Trane Tracer™ ZN cascade control

D = Large empty control box (DIN rail and terminal block + relay for TCO of electric heater)

### Digit 15 - Onboard control interface (valve opposite side)

W = Without

A = Interface for Modbus control

B = ZSM10 for Trane Tracer™ ZN control

T = Type T thermostat : ON-OFF switch / Speed selection

switch / Cool-Heat switch / Temperature setpoint

U = Type U thermostat : ON-OFF switch / Speed selection+Auto switch / Cool-Heat-Auto switch / Temperature setpoint

### Digit 16 - Fuse protection

W = Without

### Digit 17 - Water valve(s)

W = Without

A = 2-way ON/OFF

B = 3-way ON/OFF

C = 2-way modulating

D = 3-way modulating

E = 3-way ON/OFF with micrometric valve kit

F = 3-way modulating with micrometric valve kit

### Digit 18 - Drain pan/unit orientation

W = Without

H = Horizontal installation drain pan

V = Vertical installation drain pan

### Digit 19 - Condensate pump

W = Without

A = With factory-mounted condensate drain pump and drain pan

### Digit 20 - Support feet and return air grille

W = Without

F = With

### Digit 21 - Special feature

X = Standard unit

S = Special unit

## Dimensions and weights

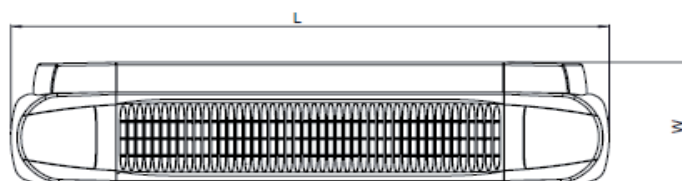
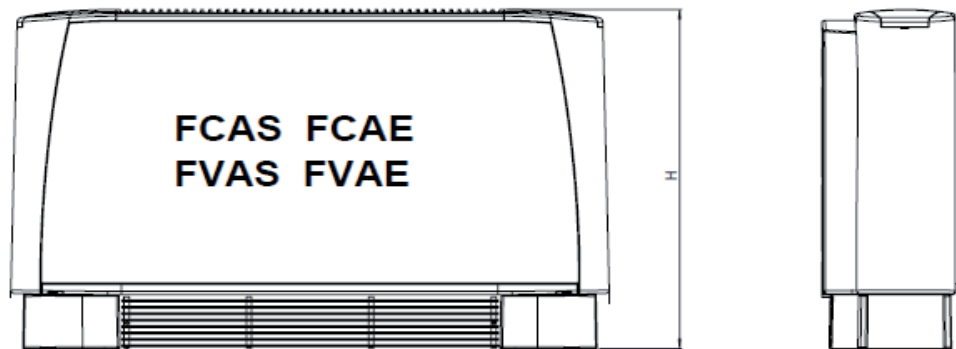

Unit dimensions (mm)

	Size	11-12	21-22	31-32-33-34	41-42-43-44	51-52	61-62-63-64
FKAS - FKAE	L	374	474	689	904	1119	1119
	H	511	511	511	511	511	511
	W	218	218	218	218	218	248
FKAS - FKAE with CleanEffects™ filter	L	374	474	689	904	1119	1119
	H	578	578	578	578	578	578
	W	218	218	218	218	218	248
FCAS - FCAE and FVAS - FVAE without support feet	L	694	794	1009	1224	1439	1439
	H	530	530	530	530	530	530
	W	225	225	225	225	225	255
FVAS - FVAE with support feet	L	694	794	1009	1224	1439	1439
	H	630	630	630	630	630	630
	W	225	225	225	225	225	255
FVAS - FVAE with CleanEffects™ filter and support feet	L	694	794	1009	1224	1439	1439
	H	697	697	697	697	697	697
	W	225	225	225	225	225	255

## Dimensions and weights

### Packaged unit dimensions (mm)

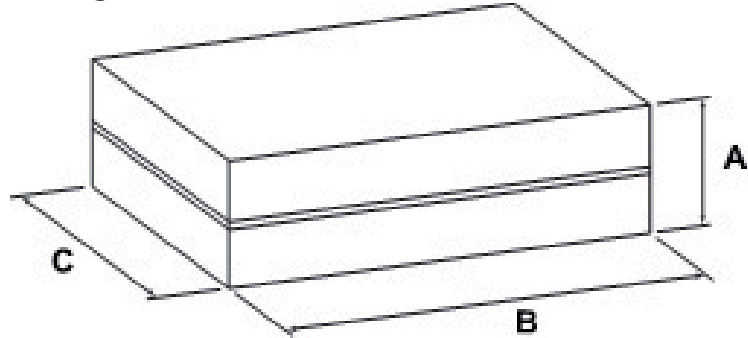

	Size	11-12	21-22	31-32-33-34	41-42-43-44	51-52	61-62-63-64
FKAS - FKAE	A	260	260	260	260	260	290
	B	720	820	820	1035	1250	1250
	C	600	600	600	600	600	600
FKAS - FKAE with CleanEffects™ filter	A	260	260	260	260	260	290
	B	720	820	820	1035	1250	1250
	C	700	700	700	700	700	700
FCAS - FCAE and FVAS - FVAE without support feet	A	260	260	260	260	260	290
	B	745	845	1060	1275	1490	1490
	C	600	600	600	600	600	600
FVAS - FVAE with support feet	A	260	260	260	260	260	290
	B	745	845	1060	1275	1490	1490
	C	700	700	700	700	700	700
FVAS - FVAE with CleanEffects™ filter and support feet	A	260	260	260	260	260	290
	B	745	845	1060	1275	1490	1490
	C	800	800	800	800	800	800

Size	2-pipe unit					4-pipe unit Standard capacity heating coil					4-pipe unit Enhanced capacity heating coil				
	Gross weight with packaging		Net weight		Water Volume	Gross weight with packaging		Net weight		Water Volume	Gross weight with packaging		Net weight		Water Volume
	FKAS-FKAE	FCAS-FCAE-FVAS-FVAE	FKAS-FKAE	FCAS-FCAE-FVAS-FVAE		FKAS-FKAE	FCAS-FCAE-FVAS-FVAE	FKAS-FKAE	FCAS-FCAE-FVAS-FVAE		FKAS-FKAE	FCAS-FCAE-FVAS-FVAE	FKAS-FKAE	FCAS-FCAE-FVAS-FVAE	
	(kg)	(kg)	(kg)	(kg)	(l)	(kg)	(kg)	(kg)	(kg)	(l)	(kg)	(kg)	(kg)	(kg)	(l)
11	12.2	15.5	11.2	14.5	0.5	12.9	16.2	11.9	15.2	0.7	13.4	16.7	12.4	15.7	0.9
12	12.7	16	11.7	15	0.7	13.4	16.7	12.4	15.7	0.9					
21	13.6	17.2	11.6	15.2	0.6	14.4	18	12.4	16	0.8	15	18.6	13	16.6	1
22	14.4	18	12.4	16	0.8	15.2	18.8	13.2	16.8	1					
31	17.1	21.4	14.1	18.4	0.9	18.3	22.6	15.3	19.6	1.2	19	23.3	16	20.3	1.5
32	18.1	22.4	15.1	19.4	1.3	19.3	23.6	16.3	20.6	1.6					
33	18.1	22.5	15.1	19.5	0.9	19.3	23.7	16.3	20.7	1.2	20	24.4	17	21.4	1.5
34	19.1	23.5	16.1	20.5	1.3	20.3	24.7	17.3	21.7	1.6					
41	21.9	26.9	18.9	23.9	1.3	23.4	28.4	20.4	25.4	1.7	24.3	29.3	21.3	26.3	2.1
42	23.1	28.1	20.1	25.1	1.7	24.6	29.6	21.6	26.6	2.1					
43	22.8	27.7	19.8	24.7	1.6	24.3	29.2	21.3	26.2	2.1	25.2	30.1	22.2	27.1	2.6
44	24.1	29	21.1	26	2.2	25.6	30.5	22.6	27.5	2.7					
51	27	32.1	23	28.1	1.7	28.8	33.9	24.8	29.9	2.2	29.9	35	25.9	31	2.7
52	28.5	33.6	24.5	29.6	2.4	30.3	35.4	26.3	31.4	2.9					
61	30.2	35.7	26.2	31.7	1.9	32	37.5	28	33.5	2.5	33.1	38.6	29.1	34.6	3.1
62	31.7	37.2	27.7	33.2	2.8	33.5	39	29.5	35	3.4					
63	30.4	35.9	26.4	31.9	1.9	32.2	37.7	28.2	33.7	2.5	33.3	38.8	29.3	34.8	3.1
64	31.9	37.4	27.9	33.4	2.8	33.7	39.2	29.7	35.2	3.4					



# General data

## AC fan motor unit : FVAS / FCAS / FKAS

		11	12	21	22	31	32	33	34	41	42
Total cooling capacity <sup>(1)</sup>	(kW)	0.9	1.0	1.3	1.4	1.8	1.9	2.1	2.3	2.9	3.3
Sensible cooling capacity <sup>(1)</sup>	(kW)	0.7	0.8	1.0	1.1	1.3	1.4	1.6	1.7	2.2	2.4
Water flow (cooling) <sup>(1)</sup>	(l/h)	148	176	215	246	307	326	369	393	506	560
Water pressure drop (cooling) <sup>(1)</sup>	(kPa)	5	4	4	9	12	7	16	9	11	21
Heating capacity <sup>(2)</sup>	(kW)	1.2	1.3	1.6	1.7	2.2	2.2	2.6	2.7	3.6	3.8
Electric heater capacity	(W)	650	650	400-600-1000	400-600-1000	600-900-1500	600-900-1500	600-900-1500	600-900-1500	750-1250-2000	750-1250-2000
Airflow at 0Pa <sup>(1)</sup>	(m <sup>3</sup> /h)	175	175	220	220	270	270	335	335	495	495
Fan power input <sup>(1)</sup>	(W)	25	25	22	22	25	25	28	28	39	39
Maximum fan motor input	(W)/(A)	33 / 0.16	33 / 0.16	40 / 0.18	40 / 0.18	49 / 0.23	49 / 0.23	57 / 0.26	57 / 0.26	61 / 0.27	61 / 0.27
Sound power level <sup>(3)</sup>	(dB(A))	32 / 39 / 45	32 / 39 / 45	30 / 40 / 47	30 / 40 / 47	36 / 40 / 49	36 / 40 / 49	33 / 39 / 47	33 / 39 / 47	31 / 41 / 43	31 / 41 / 43
Cabinet unit dimensions (LxWxH) <sup>(5)</sup>	(mm)	694x225x530	694x225x530	794x225x530	794x225x530	1009x225x530	1009x225x530	1009x225x530	1009x225x530	1224x225x530	1224x225x530
Weight <sup>(5)</sup>	(kg)	13	13	14	16	18	21	19	22	21	24
Concealed units dimensions (LxWxH) <sup>(7)</sup>	(mm)	415x218x511	415x218x511	515x218x511	515x218x511	730x218x511	730x218x511	730x218x511	730x218x511	945x218x511	945x218x511
Weight <sup>(6)</sup>	(kg)	9	10	13	15	18	20	19	21	21	23

## AC fan motor unit : FVAS / FCAS / FKAS - continued

		43	44	51	52	61	62	63	64
Total cooling capacity <sup>(1)</sup>	(kW)	3.4	3.9	4.3	4.6	5.2	5.7	5.9	6.5
Sensible cooling capacity <sup>(1)</sup>	(kW)	2.6	2.9	3.3	3.5	4.1	4.4	4.7	5.1
Water flow (cooling) <sup>(1)</sup>	(l/h)	580	665	739	799	894	987	1011	1127
Water pressure drop (cooling) <sup>(1)</sup>	(kPa)	14	25	25	20	18	14	22	18
Heating capacity <sup>(2)</sup>	(kW)	4.1	4.7	5.2	5.6	6.7	7.4	7.7	8.5
Electric heater capacity	(W)	750-1250-2000	750-1250-2000	1000-1500-2500	1000-1500-2500	1000-1500-2500	1000-1500-2500	1000-1500-2500	1000-1500-2500
Airflow at 0Pa <sup>(1)</sup>	(m <sup>3</sup> /h)	590	590	735	735	1020	1020	1210	1210
Fan power input <sup>(1)</sup>	(W)	55	55	79	79	105	105	134	134
Maximum fan motor input	(W)/(A)	88 / 0.39	88 / 0.39	103 / 0.47	103 / 0.47	130 / 0.58	130 / 0.58	176 / 0.78	176 / 0.78
Sound power level <sup>(3)</sup>	(dB(A))	37 / 46 / 52	37 / 46 / 52	42 / 51 / 56	42 / 51 / 56	45 / 56 / 60	45 / 56 / 60	50 / 58 / 64	50 / 58 / 64
Cabinet unit dimensions (LxWxH) <sup>(4)</sup>	(mm)	1224x225x530	1224x225x530	1439x225x530	1439x225x530	1439x255x530	1439x255x530	1439x255x530	1439x255x530
Weight <sup>(5)</sup>	(kg)	22	25	26	30	35	41	36	42
Concealed units dimensions (LxWxH) <sup>(6)</sup>	(mm)	945x218x511	945x218x511	1160x218x511	1160x218x511	1160x248x511	1160x248x511	1160x248x511	1160x248x511
Weight <sup>(5)</sup>	(kg)	22	24	25	28	33	38	33	39

## EC fan motor unit : FVAE / FCAE / FKAE

		21	22	33	34	43	44	51	52	63	64
Total cooling capacity <sup>(1)</sup>	(kW)	1.2	1.3	2.2	2.3	2.9	3.2	3.7	3.8	4.9	5.3
Sensible cooling capacity <sup>(1)</sup>	(kW)	0.9	1.0	1.7	1.7	2.2	2.4	2.8	2.8	3.8	4.0
Water flow (cooling) <sup>(1)</sup>	(l/h)	205	229	377	393	506	551	637	661	837	904
Water pressure drop (cooling) <sup>(1)</sup>	(kPa)	4	8	17	9	11	18	19	14	16	12
Heating capacity <sup>(2)</sup>	(kW)	1.5	1.6	2.7	2.8	3.6	3.9	4.5	4.6	6.4	6.7
Electric heater capacity	(W)	400-600-1000	400-600-1000	600-900-1500	600-900-1500	750-1250-2000	750-1250-2000	1000-1500-2500	1000-1500-2500	1000-1500-2500	1000-1500-2500
Airflow	(m <sup>3</sup> /h)	220	210	350	340	495	475	610	585	945	910
Fan power input <sup>(1)</sup>	(W)	11	11	12	12	15	15	19	19	41	41
Maximum fan motor input	(W)/(A)	21	21	25	25	32	32	41	41	99	99
Sound power level <sup>(3)</sup>	(dB(A))	30 / 41 / 51	30 / 41 / 51	30 / 42 / 51	30 / 42 / 51	33 / 44 / 54	33 / 44 / 54	37 / 48 / 57	37 / 48 / 57	44 / 55 / 64	44 / 55 / 64
Cabinet unit dimensions (LxWxH) <sup>(4)</sup>	(mm)	794x225x530	794x225x530	1009x225x530	1009x225x530	1224x225x530	1224x225x530	1439x225x530	1439x225x530	1439x255x530	1439x255x530
Weight <sup>(5)</sup>	(kg)	14	16	19	22	22	25	26	30	36	42
Concealed units dimensions (LxWxH) <sup>(6)</sup>	(mm)	515x218x511	515x218x511	730x218x511	730x218x511	945x218x511	945x218x511	1160x218x511	1160x218x511	1160x248x511	1160x248x511
Weight <sup>(5)</sup>	(kg)	13	15	19	21	22	24	25	28	33	39

Power supply : 230V/50Hz/1Ph

(1)Eurovent certified data for 2-pipe, air: 27°C/19°C, water: 7/12°C, Medium speed

(2)Eurovent certified data for 2-pipe, air: 20°C, water inlet: 50°C, cooling water flow, medium speed

(3)Eurovent Certified data according to Eurovent specification 8/2 (ISO 3741/88), standard motor.

(4)For Front return (FCA) and vertical return (FVA) model without feet, Increase unit height by 100 mm for the version with feet

(5)Without water content, options, or accessories

(6)For unit without auxiliary drain pan, without water valves kit



## General data

---

### Operating limits

Maximum entering water temperature: +80°C.  
Minimum water temperature without glycol: +5°C.  
For lower water temperatures please contact your local sales office.  
Maximum water operating pressure: 1000 kPa (10 bars).

## Performance data

---

### 2-pipe units - AC fan motor

Performances given for unit with standard filters at 0Pa external static pressure.

Cooling mode: Air 27°C (Dry bulb) / 19°C (Wet Bulb) – Water 7°C (Inlet) / 12°C (Outlet)

Heating mode: Air 20°C – Water 50°C (Inlet)

#### Legend

- Ⓛ Performances at Low speed on Standard Speed setting configuration
- Ⓜ Performances at Medium speed on Standard Speed setting configuration
- Ⓜ Performances at High speed on Standard Speed setting configuration
- Performances at Low speed on High Speed setting configuration
- Performances at Medium speed on High Speed setting configuration
- Performances at High speed on High Speed setting configuration



# Performance data

## 2-pipe units - AC fan motor

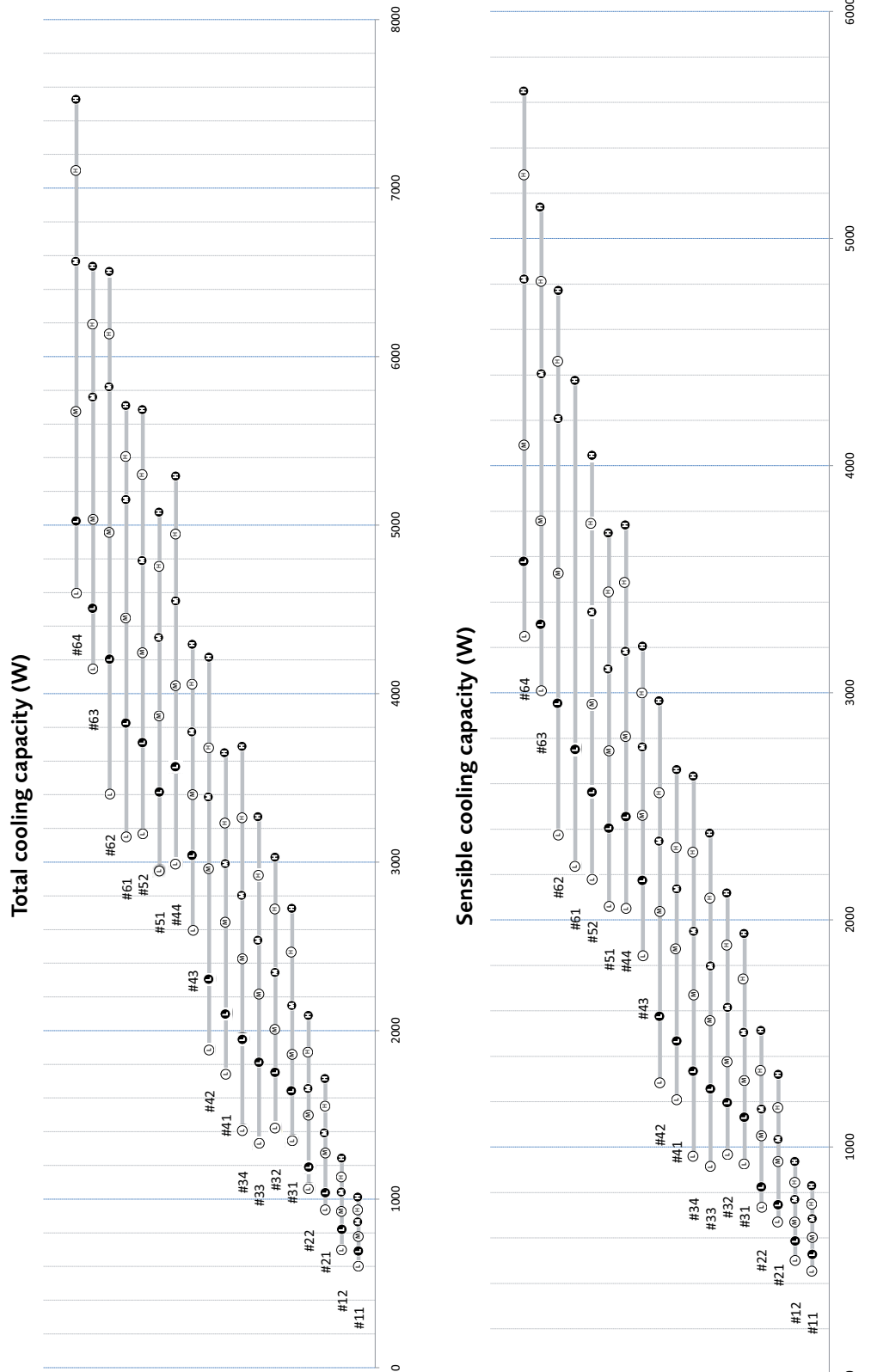

# Performance data

## 2-pipe units - AC fan motor

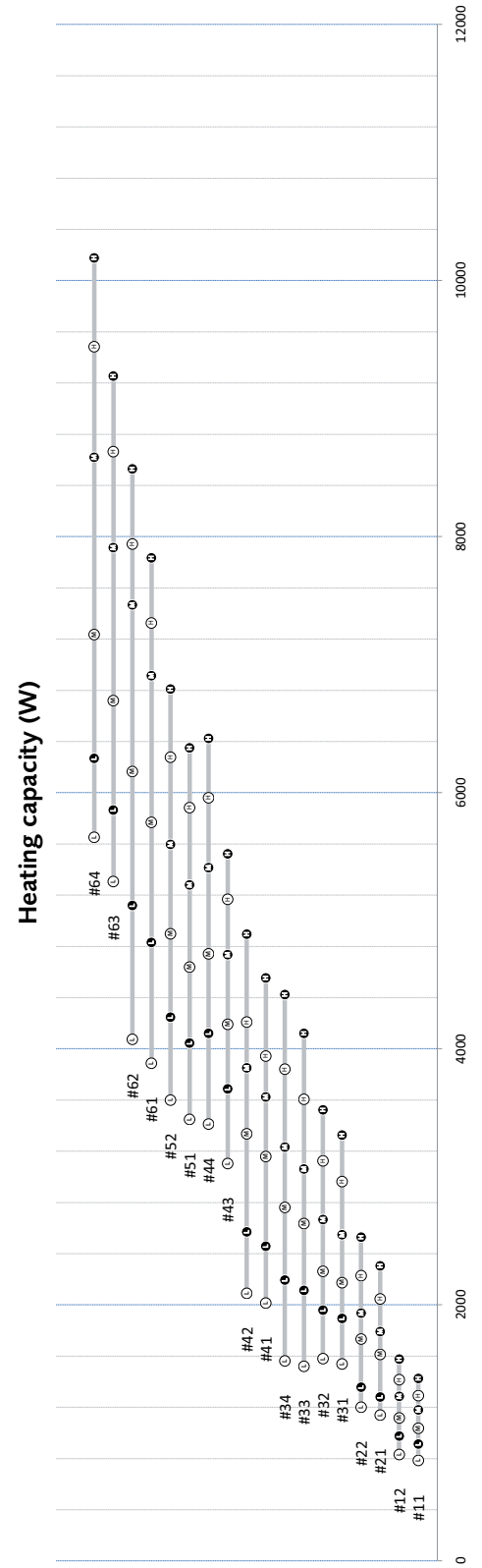
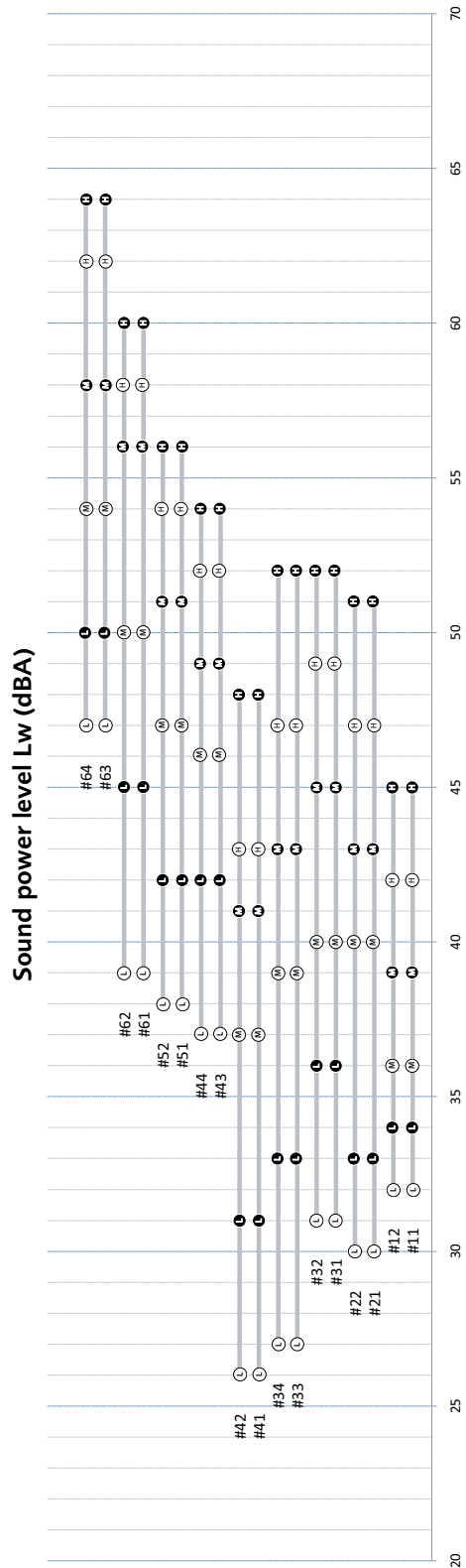



# Performance data

## 2-pipe units - AC fan motor

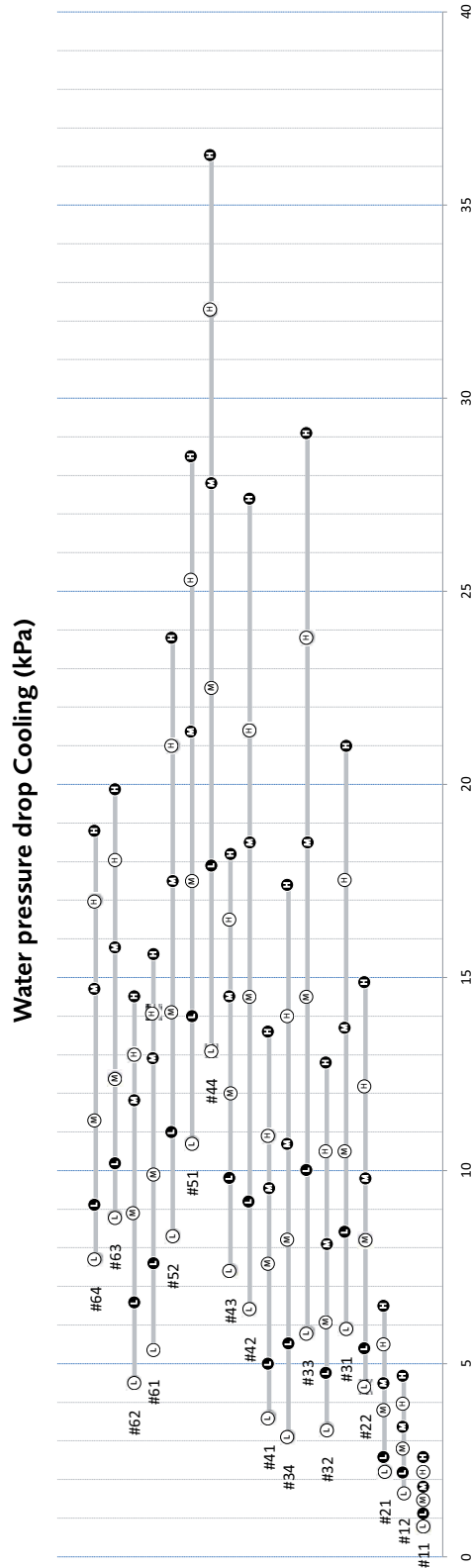

## Performance data

---

### 2-pipe units - EC fan motor

Performances given for unit with standard filters at 0Pa external static pressure.

Cooling mode: Air 27°C (Dry bulb) / 19°C (Wet Bulb) – Water 7°C (Inlet) / 12°C (Outlet)

Heating mode: Air 20°C – Water 50°C (Inlet)

#### Legend

- ①V Performances at 1.0VDC on EC motor
- ③V Performances at 3.0VDC on EC motor
- ⑤V Performances at 5.0VDC on EC motor
- ⑦.5V Performances at 7.5VDC on EC motor
- ⑩V Performances at 10VDC on EC motor

# Performance data

## 2-pipe units - EC fan motor

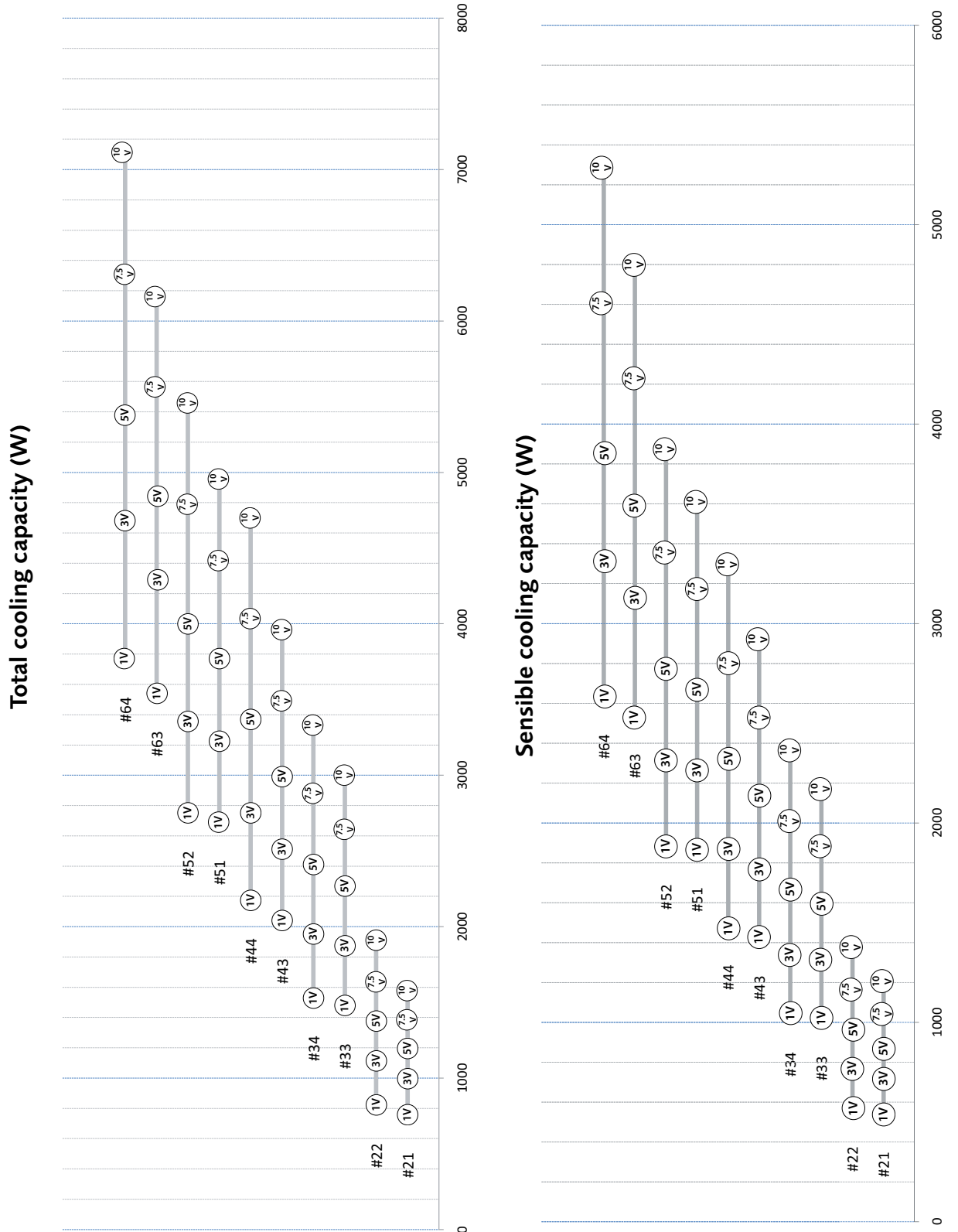



# Performance data

## 2-pipe units - EC fan motor

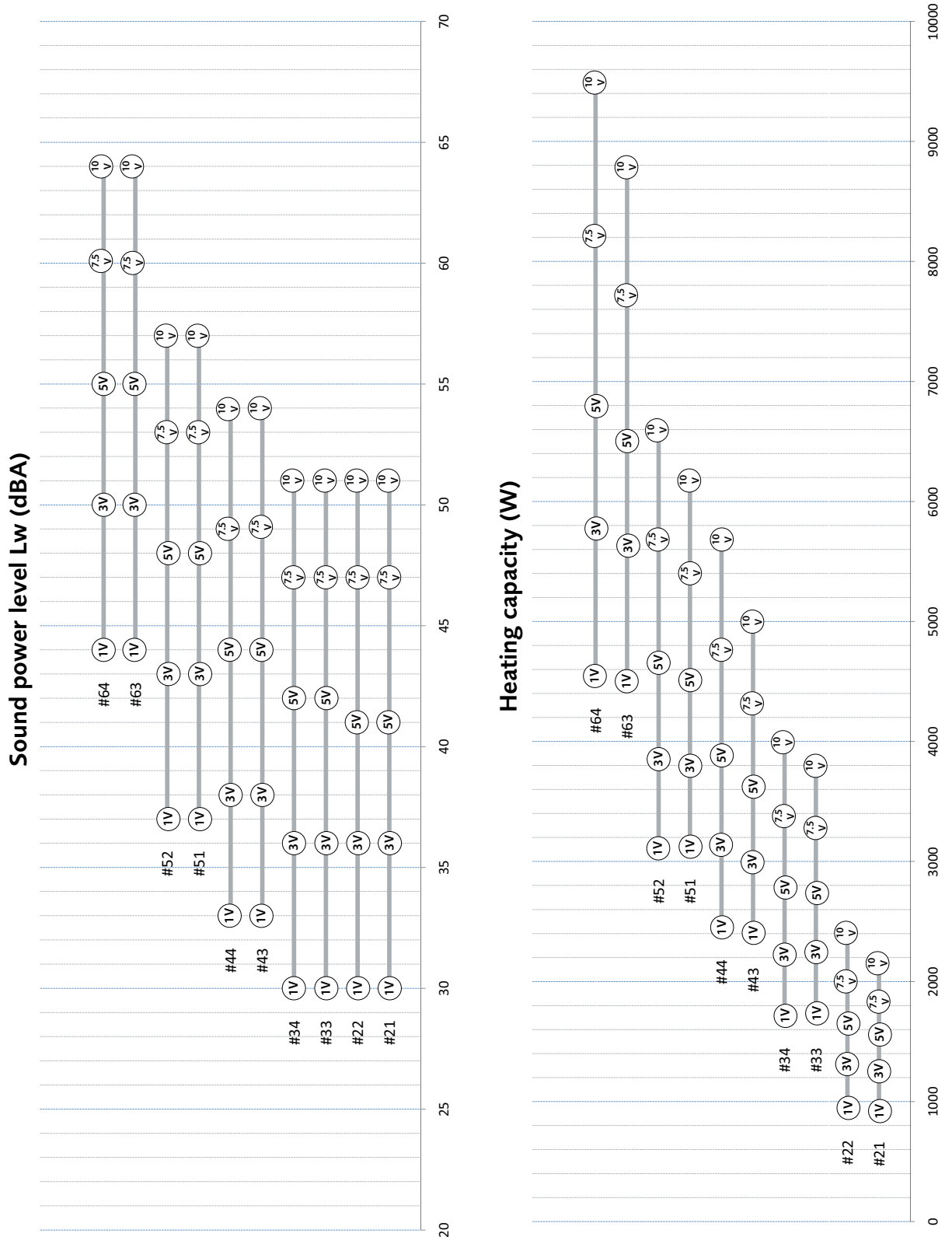



# Performance data

## 2-pipe units - EC fan motor

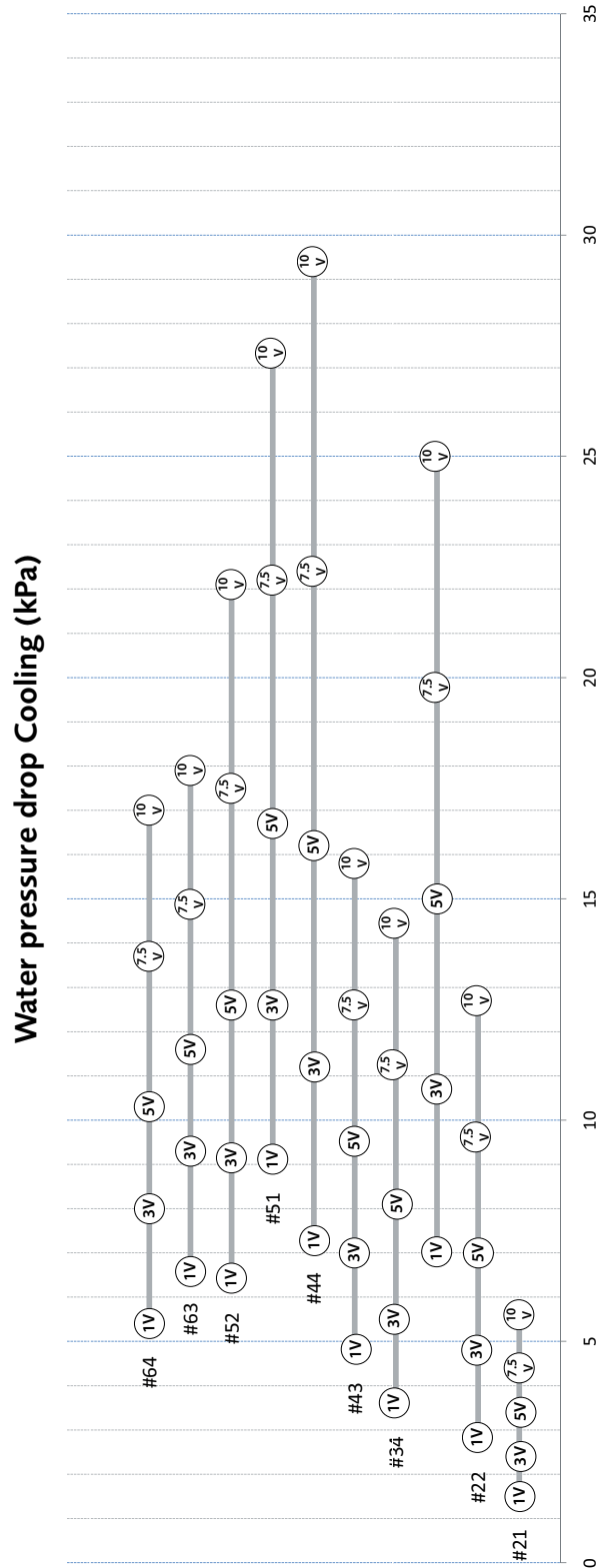

## Performance data

---

### 4-pipe units - AC fan motor

Performances given for unit with standard filters at 0Pa external static pressure.

Cooling mode: Air 27°C (Dry bulb) / 19°C (Wet Bulb) – Water 7°C (Inlet) / 12°C (Outlet)

Heating mode: Air 20°C – Water 70°C (Inlet) / 60°C (Outlet)

#### Legend

- Ⓕ Performances at Low speed on Standard Speed setting configuration
- Ⓜ Performances at Medium speed on Standard Speed setting configuration
- Ⓗ Performances at High speed on Standard Speed setting configuration
- Ⓛ Performances at Low speed on High Speed setting configuration
- Ⓜ Performances at Medium speed on High Speed setting configuration
- Ⓗ Performances at High speed on High Speed setting configuration



# Performance data

## 4-pipe units - AC fan motor

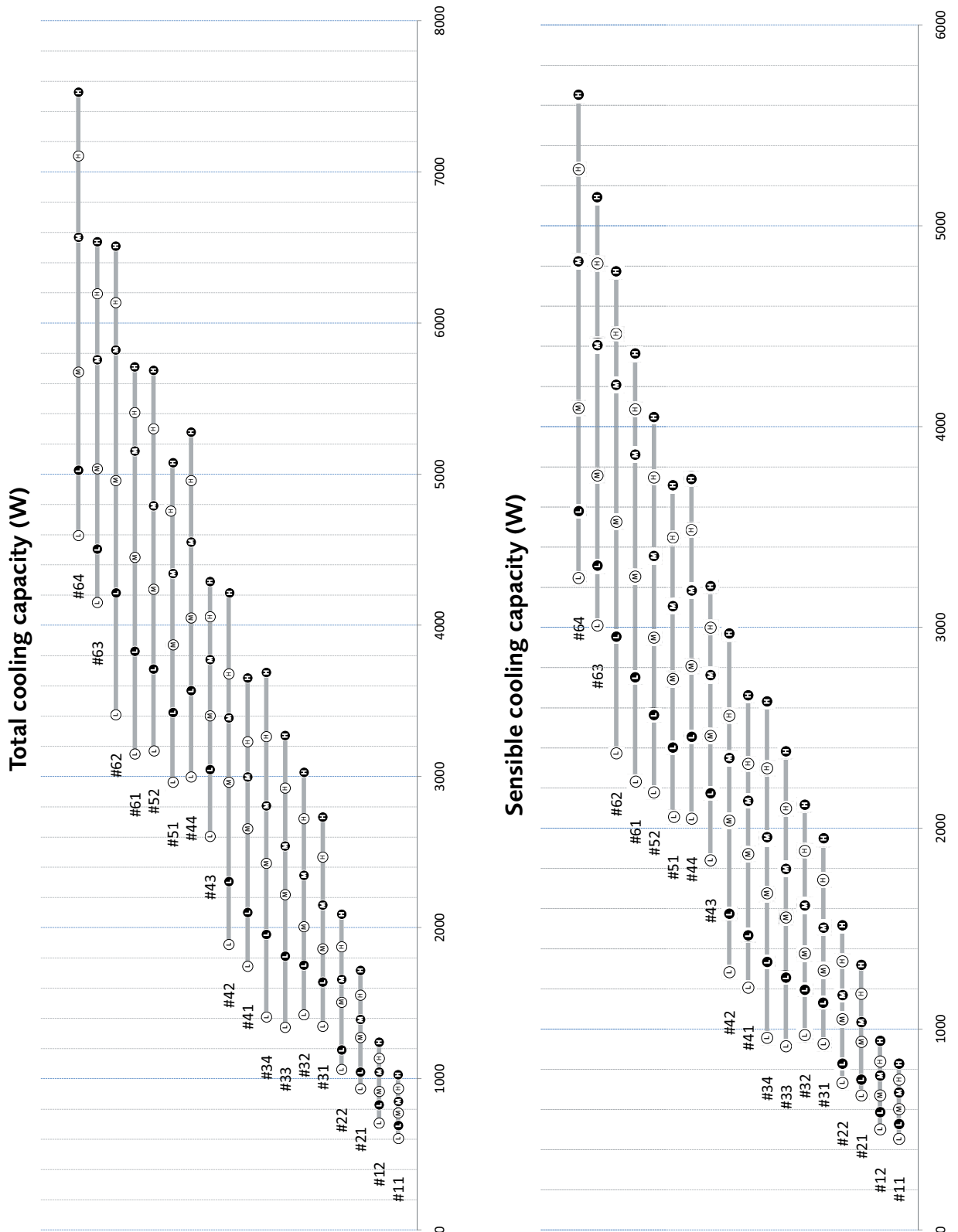

# Performance data

## 4-pipe units - AC fan motor

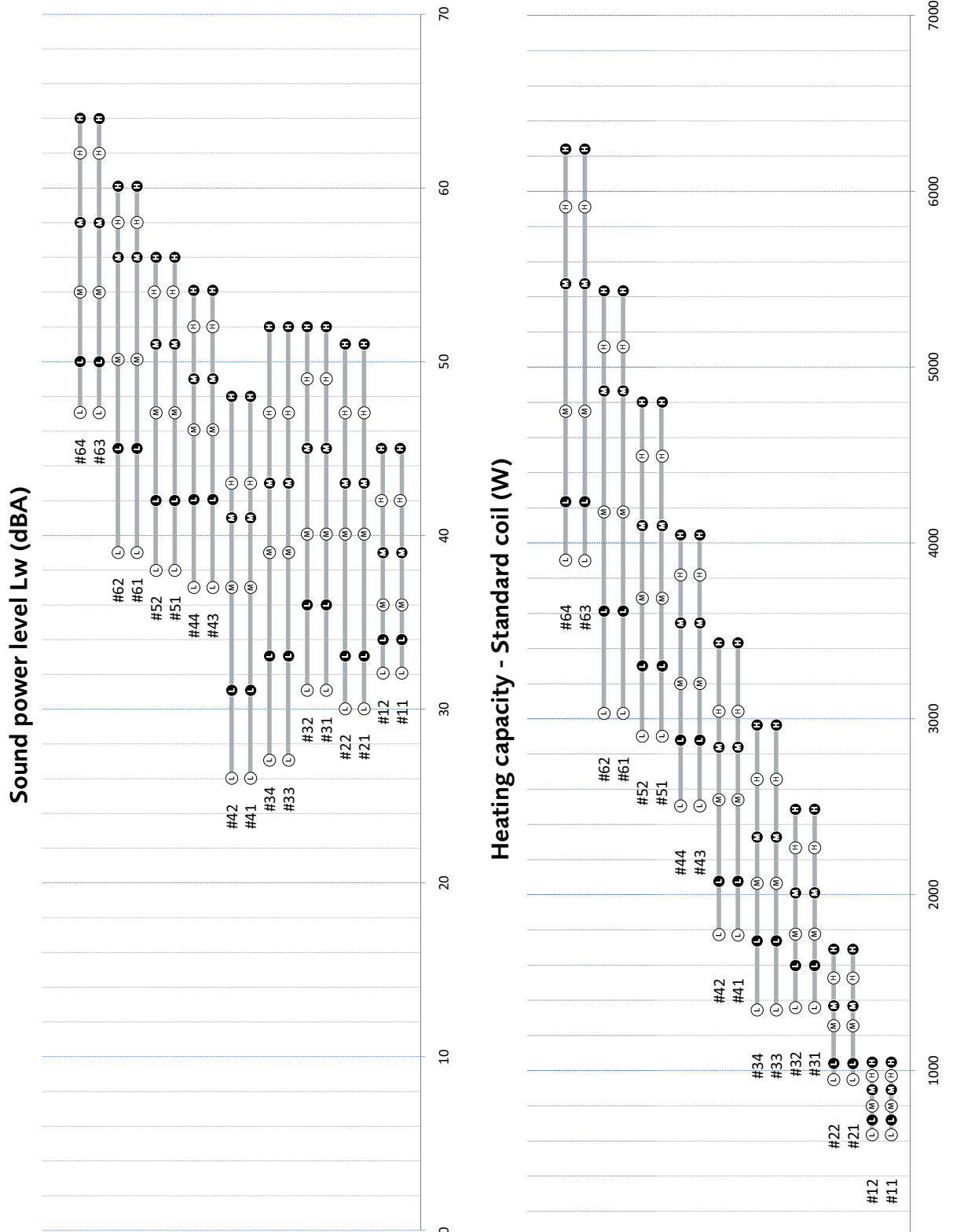

# Performance data

## 4-pipe units - AC fan motor

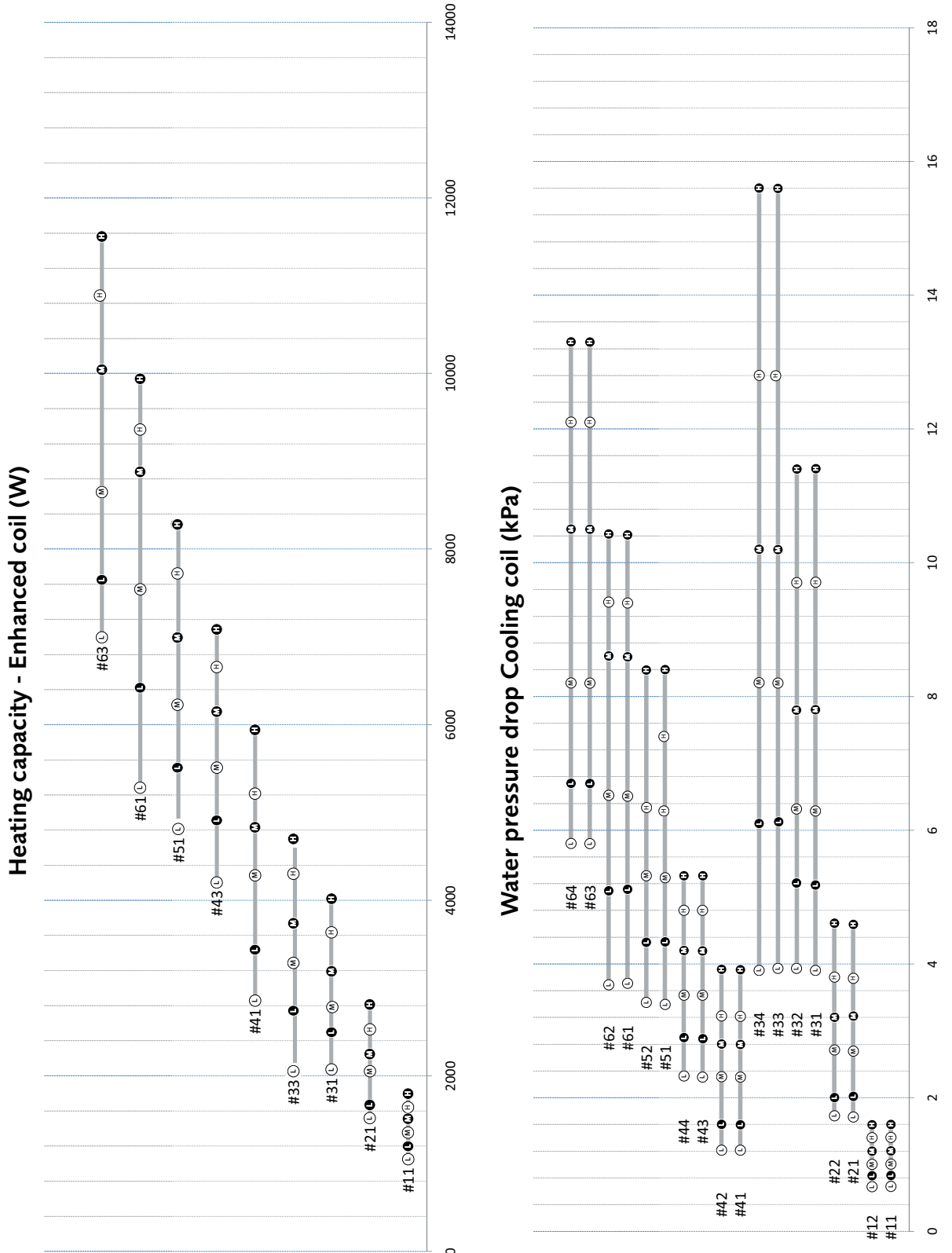

# Performance data

## 4-pipe units - AC fan motor

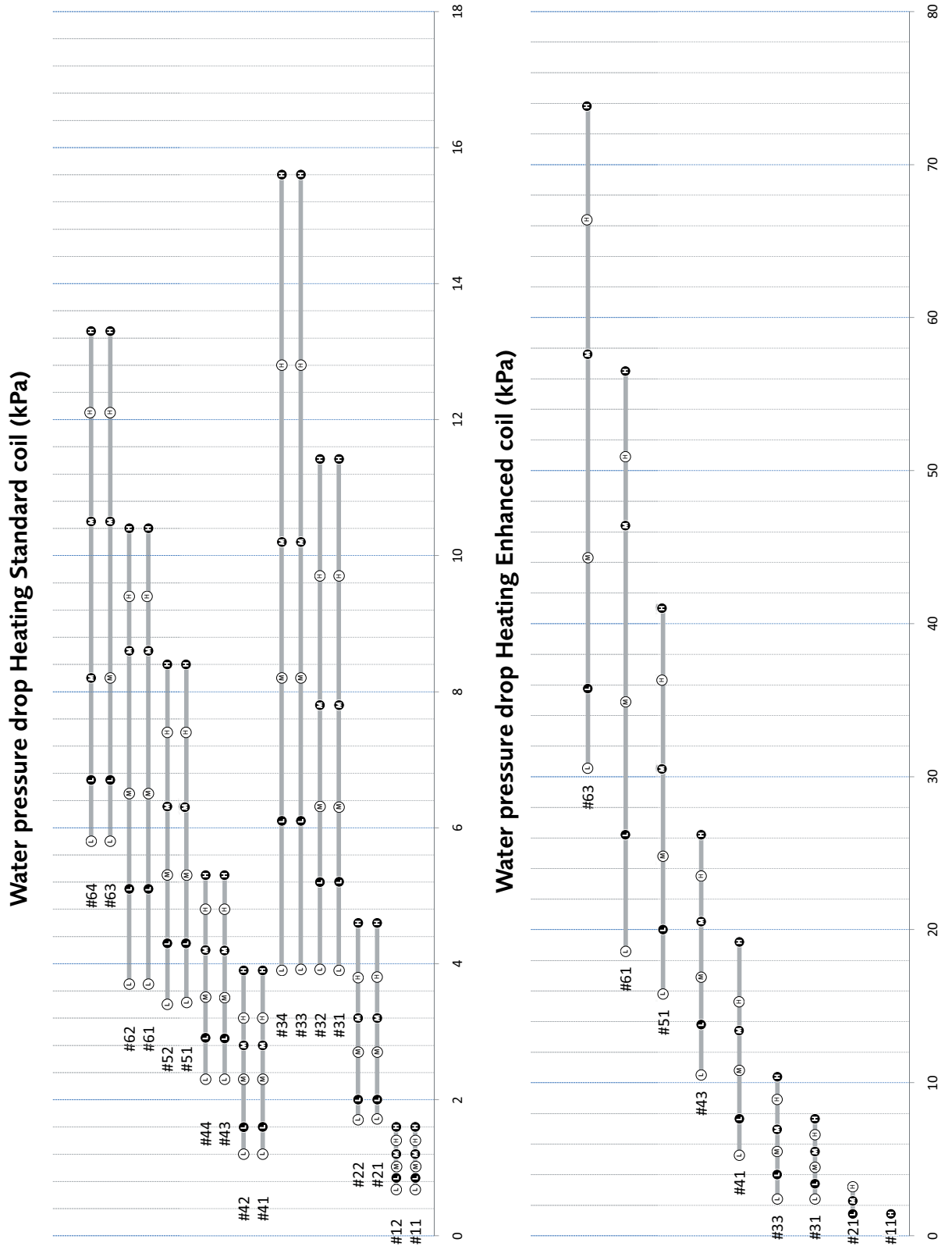



## Performance data

---

### 4-pipe units - EC fan motor

Performances given for unit with standard filters at 0Pa external static pressure.

Cooling mode: Air 27°C (Dry bulb) / 19°C (Wet Bulb) – Water 7°C (Inlet) / 12°C (Outlet)

Heating mode: Air 20°C – Water 70°C (Inlet) / 60°C (Outlet)

#### Legend

- ①V Performances at 1.0VDC on EC motor
- ③V Performances at 3.0VDC on EC motor
- ⑤V Performances at 5.0VDC on EC motor
- ⑦.5V Performances at 7.5VDC on EC motor
- ⑩V Performances at 10VDC on EC motor



# Performance data

## 4-pipe units - EC fan motor

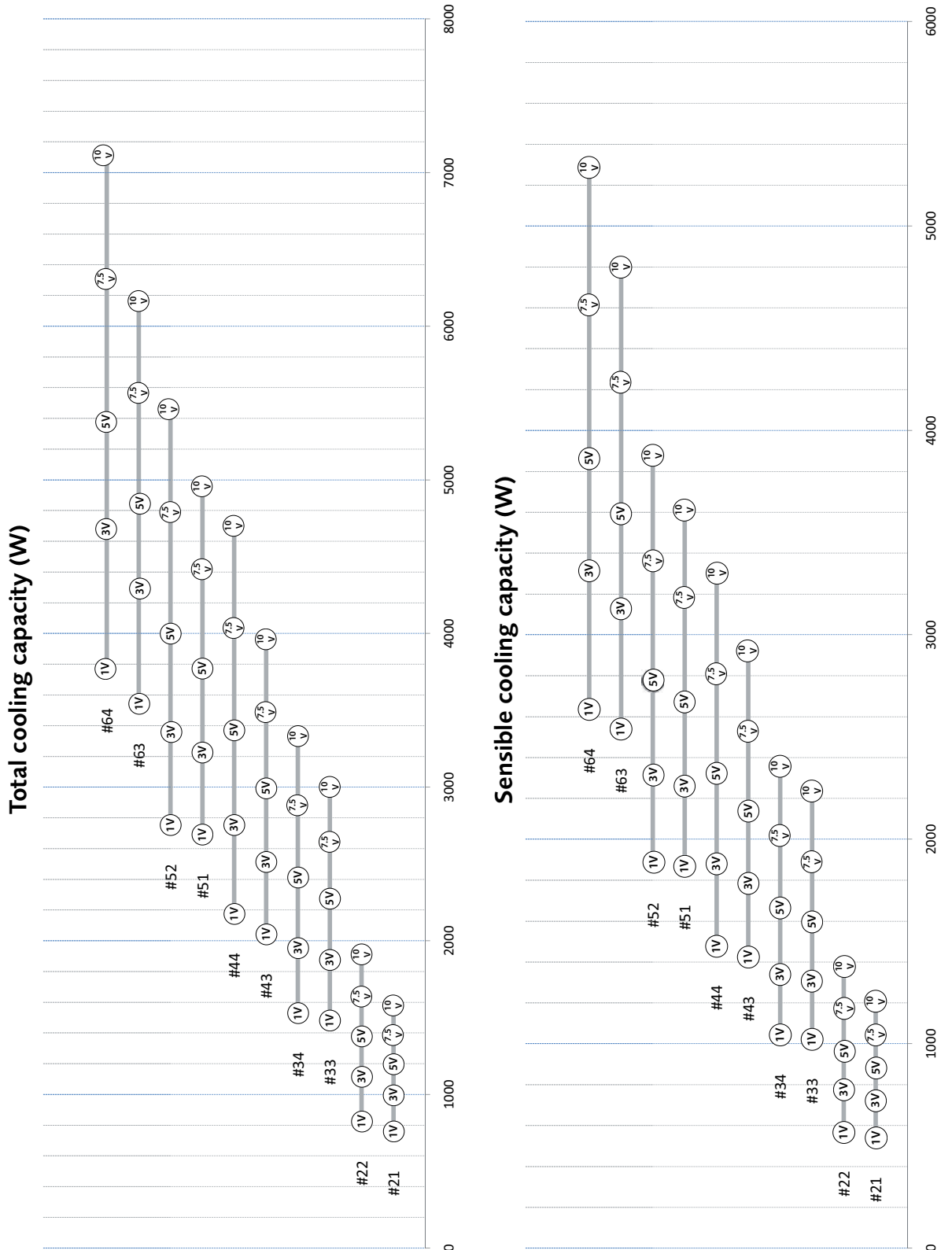

# Performance data

## 4-pipe units - EC fan motor

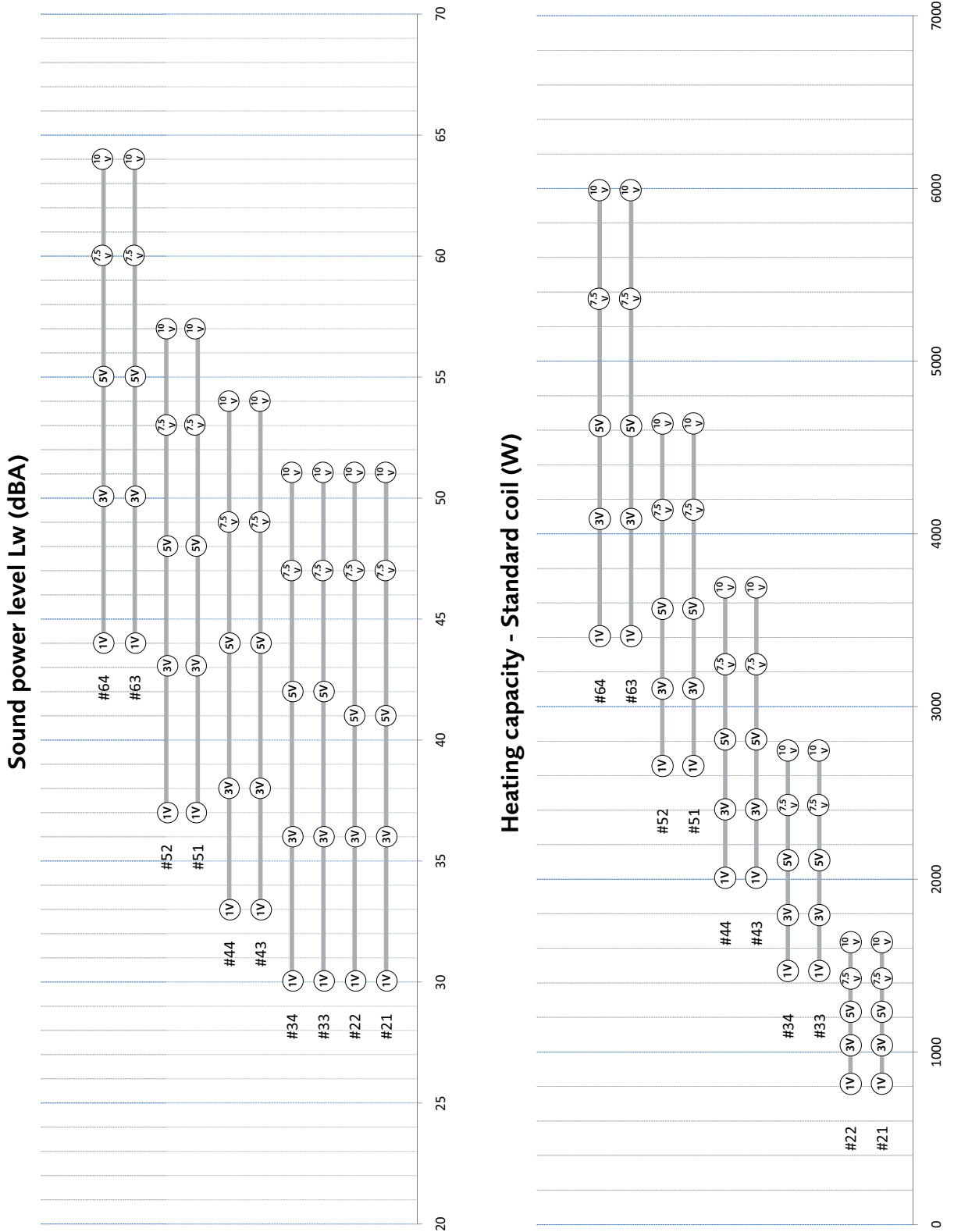

# Performance data

## 4-pipe units - EC fan motor

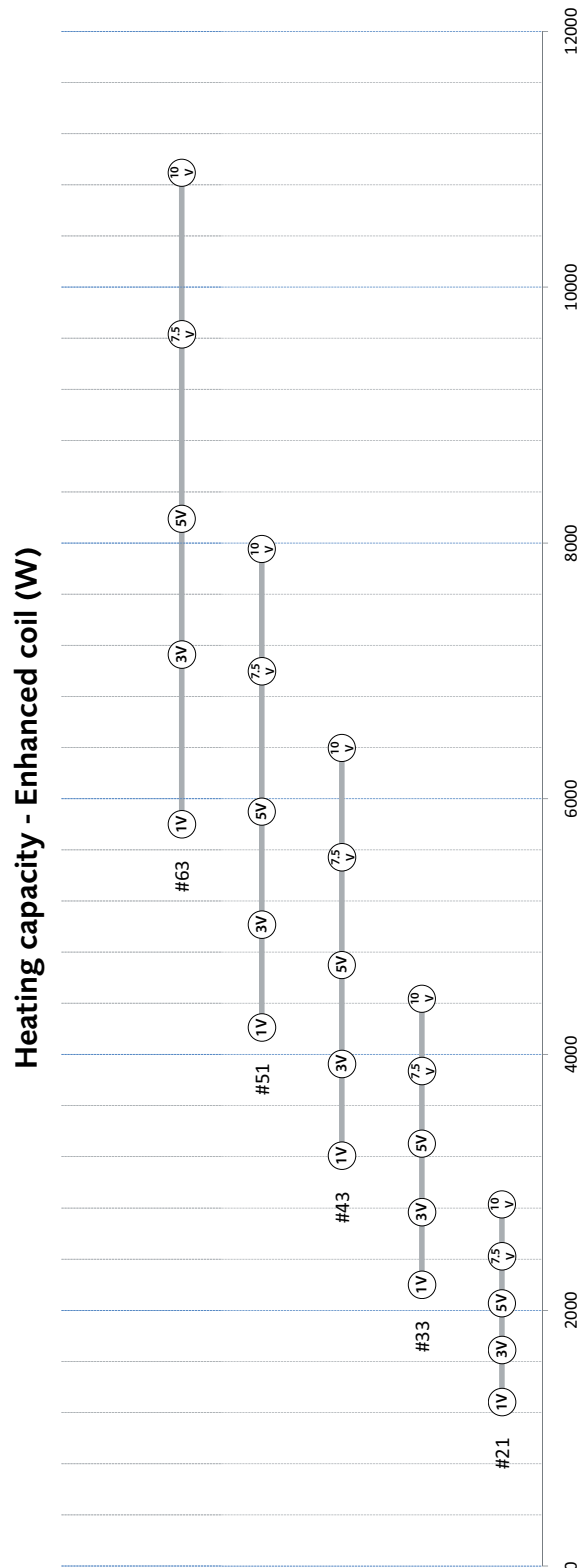

# Performance data

## 4-pipe units - EC fan motor

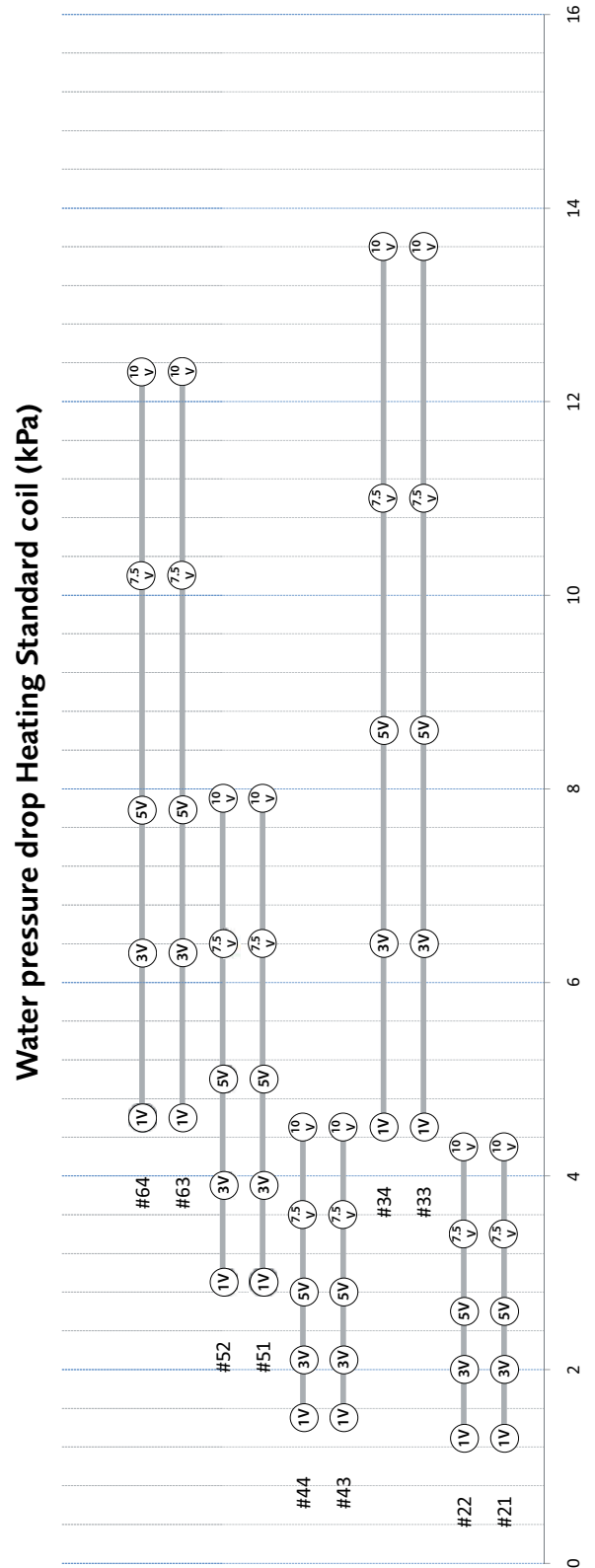
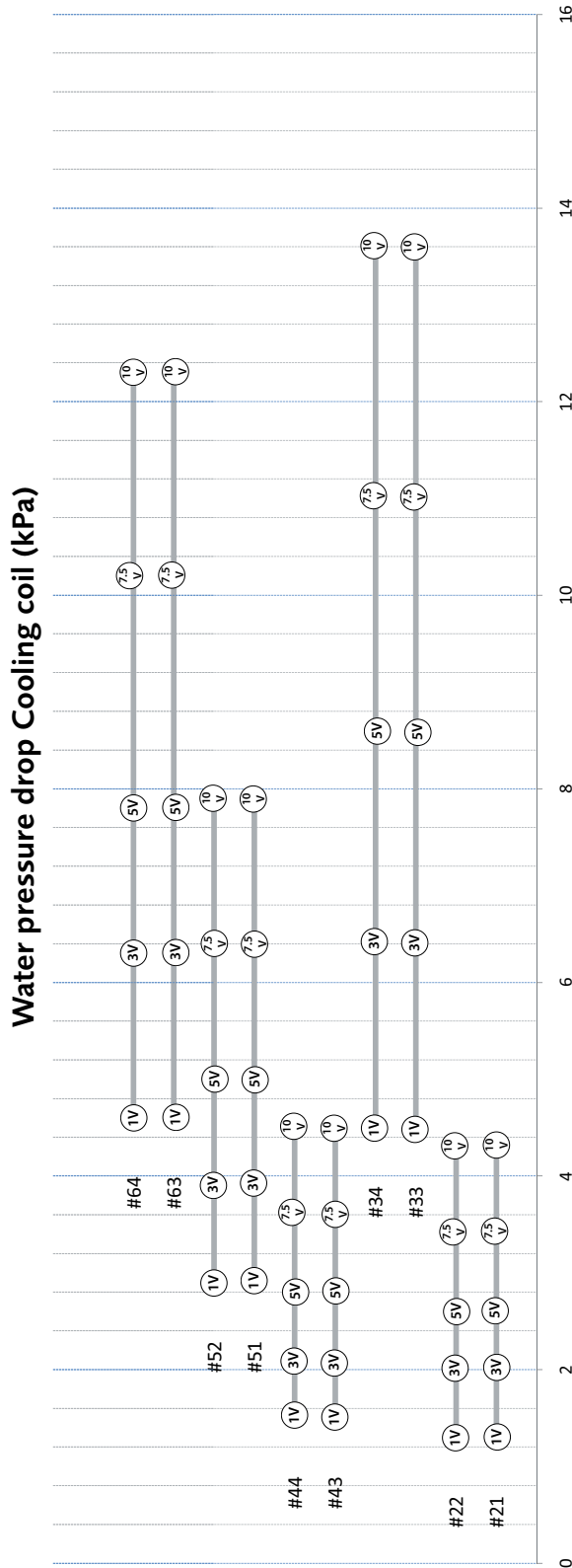

# Performance data

## 4-pipe units - EC fan motor

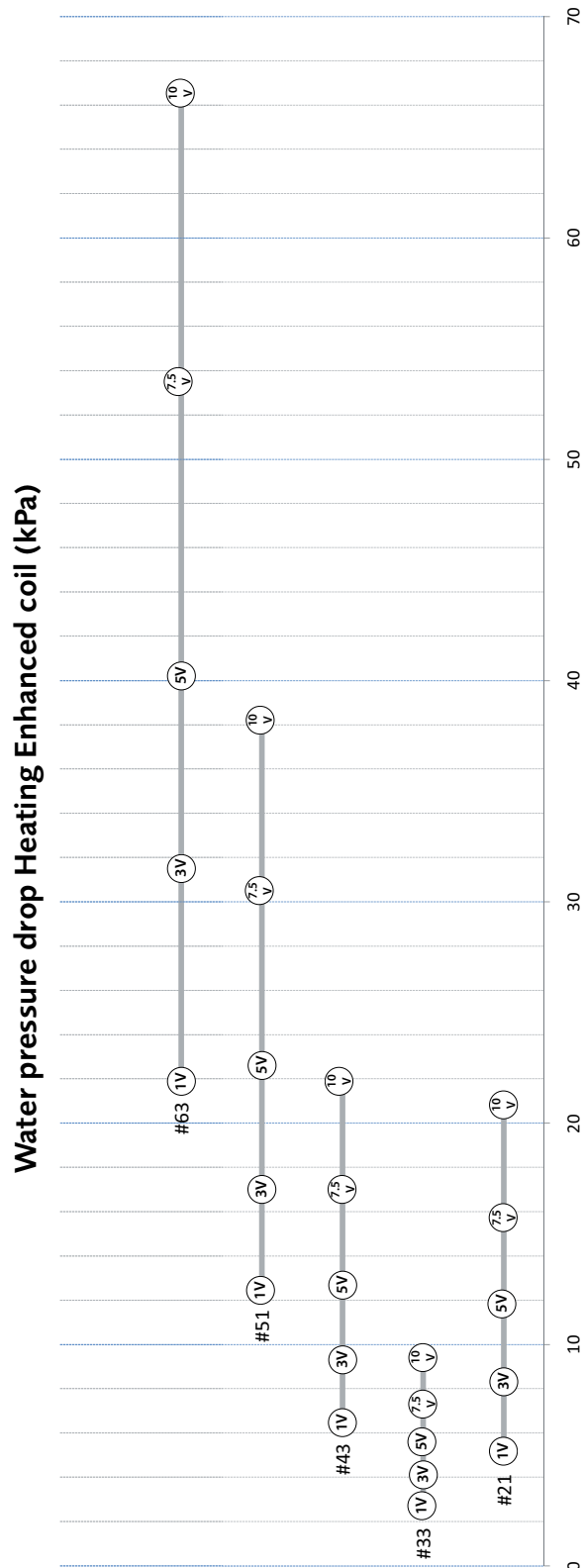



# Sound data

## Sound Power Levels - AC fan motor version

Data given at 0Pa, Sound Power Référence = 10E--12 Watt

Model	Speed	m3/h	Sound power level frequency octave band LwA							dB(A)			
			125	250	500	1000	2000	4000	8000	Glob	Lp (*)	NC	NR
FxAS11 - FxAS12	1 (L)	105	19.2	23.2	27.3	27.1	22.2	17.2	13.2	32.0	23	17	19
	2 (L)	125	20.6	25.4	29.2	29.4	24.8	19.8	14.2	34.1	25	19	21
	3 (M)	150	22.7	28.2	31.3	31.1	26.5	21.7	15	36.1	27	21	23
	4 (M)	175	24.7	31.5	34.5	32.9	30.4	24.1	16.3	39.0	30	23	25
	5 (H)	195	28	33.7	37.9	35.7	34.4	28	18.2	42.1	33	27	29
	6 (H)	220	32.9	35.6	40.1	39.2	36	30.5	20.2	44.7	36	29	31
FxAS21 - FxAS22	1 (L)	145	16.5	25.5	25.6	21.4	18	13.7	12.1	30.0	21	12	13
	2 (L)	170	19	28.7	28.4	24.5	21.6	16.2	13.4	33.0	24	15	16
	3 (M)	220	22.9	34.4	35.4	32.8	29.1	22.3	15.3	39.7	31	23	24
	4 (M)	250	25.3	36.8	39.3	36.6	33.1	27.3	18.4	43.2	34	26	28
	5 (H)	295	28.7	39.5	42.7	40.8	37.4	32.5	23.2	46.8	38	31	32
	6 (H)	340	33.1	42.9	46.6	45.5	42.3	37.9	29.4	51.0	42	35	37
FxAS31 - FxAS32	1 (L)	185	18.3	27.4	25.5	21.5	13.9	13	12.1	30.7	22	11	13
	2 (L)	235	21.7	31.7	31.3	28.5	22.4	12.6	12.1	35.9	27	18	20
	3 (M)	270	24.3	34.8	35.6	33.5	28.5	19.2	13.6	40.0	31	23	25
	4 (M)	325	28.1	38.6	40.4	38.9	34.9	26.8	16.8	44.8	36	29	30
	5 (H)	385	31.5	42	44.3	43.4	40.8	33.6	23.2	49.1	40	33	35
	6 (H)	440	35.1	44.5	46.9	46.6	44.7	38.2	28.6	52.1	43	37	39
FxAS33 - FxAS34	1 (L)	185	14.6	24	19.3	15	15.7	12.9	14.3	26.8	18	9	11
	2 (L)	265	17.3	29.1	28.8	24.4	18.5	14.7	15	33.1	24	14	16
	3 (M)	335	22.5	34.7	34.5	32	25	17.2	15.5	39.0	30	22	23
	4 (M)	400	26.2	37.3	38.2	36.9	30	20.6	15.4	42.7	34	27	28
	5 (H)	485	30.9	40.3	42.7	42	36.6	28.4	18.5	47.1	38	32	33
	6 (H)	570	35.4	44.9	46.9	46.8	42.1	35.3	25	51.8	43	37	38
FxAS41 - FxAS42	1 (L)	250	16.1	21.9	20.4	14.8	15.2	12.6	14.2	26.2	17	9	10
	2 (L)	315	17.1	26.7	26.5	19.3	18.4	12	14.7	30.7	22	12	13
	3 (M)	420	21.3	32	33.7	28.6	23.5	14.9	15.4	37.1	28	19	21
	4 (M)	495	24.7	34.9	37.5	33.7	27.5	18.2	15.9	40.8	32	24	25
	5 (H)	545	26.8	36.8	39.7	36.5	31	21.5	16.5	43.1	34	26	28
	6 (H)	650	31.7	40.8	44.2	42	37.3	28.8	19.4	47.9	39	32	33
FxAS43 - FxAS44	1 (L)	415	22	32.2	33.3	28.7	24.8	19.2	19.1	37.1	28	19	20
	2 (L)	505	26	35.9	38	34.5	30.6	23.1	19.7	41.7	33	24	26
	3 (M)	590	29.5	38.9	42.2	39.2	35.4	28.3	21.4	45.8	37	29	31
	4 (M)	680	32.5	41.8	45.3	42.9	40.1	33.7	25.1	49.2	40	33	35
	5 (H)	760	35.3	44.3	47.7	46.1	43.5	37.9	29.5	52.0	43	36	38
	6 (H)	830	37	46.1	49.6	48.3	45.9	40.8	32.6	54.1	45	38	40
FxAS51 - FxAS52	1 (L)	445	22.9	32.7	34.7	29.2	24.1	15.4	14.2	37.9	29	20	22
	2 (L)	535	26.7	36.2	38.7	35	31.1	22.3	15.4	42.2	33	25	26
	3 (M)	630	31.1	39.8	42.9	40.2	36.9	29.2	19.7	46.7	38	30	32
	4 (M)	735	34.8	43.3	46.7	44.8	41.9	35.6	26	50.8	42	35	36
	5 (H)	840	37.8	45.9	49.1	48	46	40.7	32.6	53.9	45	38	40
	6 (H)	925	39.3	47.4	50.8	50.2	48.5	43.7	35.4	55.9	47	41	43

# Sound data

Model	Speed	m3/h	Sound power level frequency octave band LwA							dB(A)			
			125	250	500	1000	2000	4000	8000	Glob	Lp (*)	NC	NR
FxAS61 - FxAS62	1 (L)	510	27	33.5	35.2	31.3	25.5	19.6	18	39.0	30	21	23
	2 (L)	655	32.5	38.8	41	38.2	33.6	25.8	19.7	45.0	36	28	30
	3 (M)	815	37.3	43.1	45.7	43.8	40.3	33.4	24.4	50.0	41	34	35
	4 (M)	1020	42.6	48.8	50.7	49.9	47.1	41.4	32.4	55.8	47	40	41
	5 (H)	1100	44.1	50.7	52.8	51.8	49.4	44.1	35.6	57.8	49	42	44
	6 (H)	1200	46.2	52.7	54.5	53.6	51.4	47.2	40.1	59.7	51	44	46
FxAS63 - FxAS64	1 (L)	735	33.7	40.6	43	39.8	35.8	28.8	23.3	46.8	38	30	31
	2 (L)	830	36.5	43.3	45.7	43.2	40.1	33.1	25.3	49.8	41	33	35
	3 (M)	980	40.3	47.4	49.2	47.5	44.9	42.2	29.4	54.0	45	37	39
	4 (M)	1210	44.2	51.3	52.8	51.7	49.6	45.1	37.1	58.0	49	42	44
	5 (H)	1365	47.9	55	56.5	55.4	53.6	49.7	41.7	61.8	53	46	48
	6 (H)	1500	50	57.2	58.6	57.6	56	52.8	45.5	64.1	55	48	50

(\*) Lp = The sound pressure levels and Nr values are referred to an installation in a 100m<sup>2</sup> room with a reverberation time of 0,5 s

## Key

- (L) Performances at Low speed on standard speed setting configuration
- (M) Performances at Medium speed on standard speed setting configuration
- (H) Performances at High speed on standard speed setting configuration
- (L) Performances at Low speed on high speed setting configuration
- (M) Performances at medium speed on high speed setting configuration
- (H) Performances at high speed on high speed setting configuration

## Sound Power Levels - EC fan motor version

Data given at 0Pa, Sound Power Référence = 10E--12 Watt

Model	V	m <sup>3</sup> /h	Sound power level frequency octave band LwA							dB(A)			
			125	250	500	1000	2000	4000	8000	Glob	Lp (*)	NC	NR
FxAE21 - FxAE22	1	120	16.5	25.5	25.6	21.4	18	13.7	12.1	30	21	10	11
	3	170	22.7	28.2	31.3	31.1	26.5	21.7	15	36	27	16	18
	5	220	24.7	34.6	37.1	34.4	30.9	25.1	16.9	41	32	21	22
	7.5	270	28.7	39.5	42.7	40.8	37.4	32.5	23.2	47	38	27	29
	10	330	33.1	42.9	46.6	45.5	42.3	37.9	29.4	51	42	32	35
FxAE33 - FxAE34	1	210	17.6	26.5	25.2	21.3	13.9	13	12.1	30	21	9	10
	3	280	21.7	31.7	31.3	28.5	22.4	12.6	12.1	36	27	13	16
	5	350	26.3	36.8	37.6	35.5	30.5	21.2	15.6	42	33	21	23
	7.5	430	29.5	40	42.3	41.4	38.6	31.6	21.2	47	38	28	30
FxAE43 - FxAE44	1	305	17.3	29.1	28.8	24.4	18.5	14.7	15	33	24	9	11
	3	395	22.9	33.1	34.2	29.6	25.7	20.1	20	38	29	16	17
	5	495	27.7	37.7	40.6	37.4	31.9	22.4	17.4	44	35	23	25
	7.5	610	32.5	41.8	45.1	42.8	40.1	33.7	25.1	49	40	30	32
	10	735	37	46.1	49.6	48.3	45.9	40.8	32.6	54	45	36	37
FxAE51 - FxAE52	1	400	22.2	31.8	33.8	28.3	23.2	14.6	13.4	37	28	13	15
	3	500	27.5	37	39.5	35.8	31.7	23.1	16.5	43	34	22	23
	5	610	32.4	41.1	44.2	41.5	38	31.1	20.9	48	39	28	29
	7.5	755	36.9	44.9	48.7	47.1	45.1	39.8	31.7	53	44	35	37
	10	890	40.3	48.4	51.8	51.2	49.5	44.7	36.4	57	48	39	41
FxAE63 - FxAE64	1	605	31.5	37.8	40	37.2	32.6	24.8	18.7	44	35	23	24
	3	785	37.3	43.1	45.7	43.8	40.3	33.4	24.4	50	41	30	32
	5	945	41.8	47.7	50.1	48.9	46.3	40.6	31.6	55	46	36	38
	7.5	1175	46.3	52.9	54.7	53.9	51.6	47.4	40.2	60	51	42	43
	10	1395	50	57.2	58.6	57.6	56	52.8	45.5	64	55	46	47

(\*) Lp = The sound pressure levels and Nr values are referred to an installation in a 100m<sup>2</sup> room with a reverberation time of 0,5 s



## Factory-installed options

### Access side configuration

The unit can be delivered with the water valve package on the right or left hand side. The control box is always mounted on the opposite side of the water valve package. There are 2 pre-cut circles in the sheet metal for fresh air intake, one each side of the unit. The one to be used is opposite side of the control box, same side as the water valve package.

### Fan speed selection (AC fan motor)

All unit models have a 6 fan speed motor, 3 of which are connected in the factory. There are 2 possibilities for factory default speed setting (standard and high speed setting). The fan speed selection can be changed on site by moving the speed wire from the quick connect terminal strip to the ones on the motor auto-transformer. The access is completed easily through the return air side.

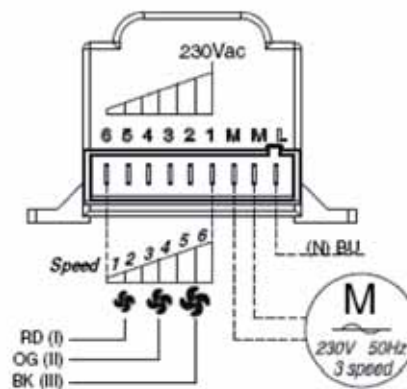

### Fan speed (EC fan motor)

The fan speed varies in function of the control input voltage from 1 to 10 volts direct current.



## Factory-installed options

### Filter type

Three options are available:

- Standard version is classified G0 made of polypropylene honeycomb design. It is washable and easily removable without any tools.
- A EU3 filter class made of 8 mm-thick polyester media mounted on a metallic frame is available as a factory-mounted option.
- The CleanEffects™ electrostatic filter is made of a combination of 2 filter technologies: a G0 pre filter catches big and medium sized particles in the air. A second filter uses electrostatic forces to catch fine to micrometric particles and is composed of charging area where air crosses an electric field, and a catching area where air passes through a set of negatively-charged catching plates.

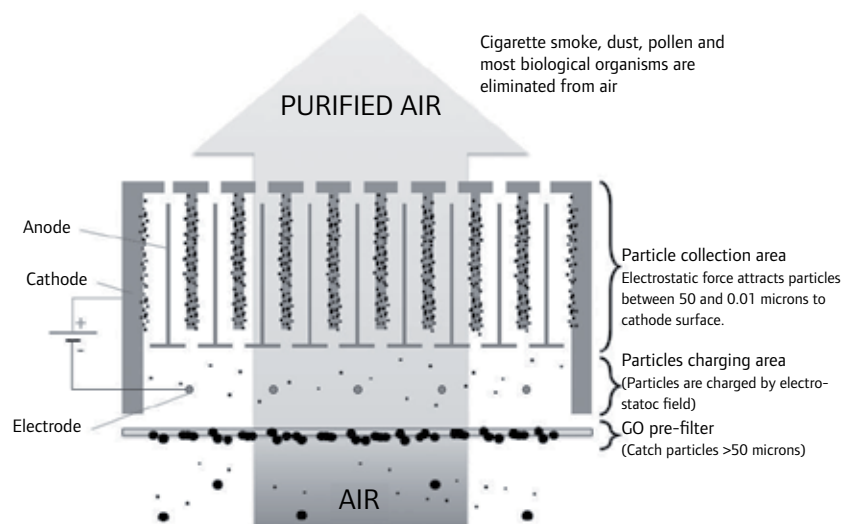

### Water valves- cooling and heating

2-way and 3-way water valves for the cooling and heating coil are available factory-mounted with all control options. Water valves are delivered with a thermal actuator using hot wax motor. There is also a modulating water valve actuator available with the Trane Tracer™ ZN controller for both 2 and 4-pipe applications. When configured in cascade control and while in cooling mode, it will limit the discharge air temperature to avoid cold air drafts for a better ambient control and improved comfort

#### 3-way ON/OFF with micrometric valve kit

Comprised of valve with electric motor and mounting kit with micrometric shut off valve

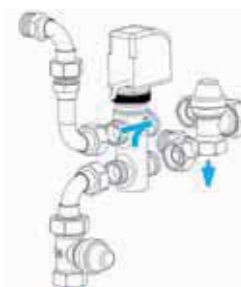

#### 3-way modulating with micrometric valve kit

Comprised of valve with electric motor and mounting kit with micrometric shut off valve

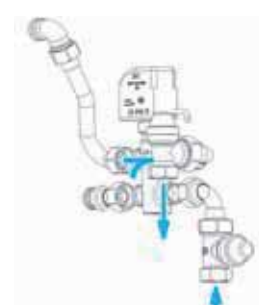

## Factory-installed options

---

### On/off valves with hot wax actuator

In order to save time on the job site, on/off 2 way and 3 way valves are available as a pre-assembled kits including pipes and connections

3 Way / 4 ports

2 Way / 2 ports

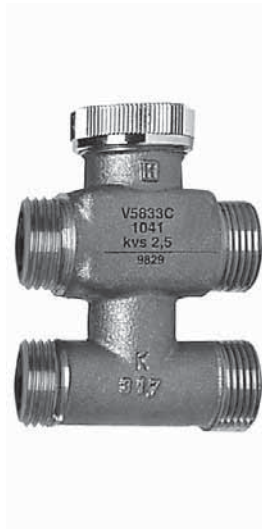
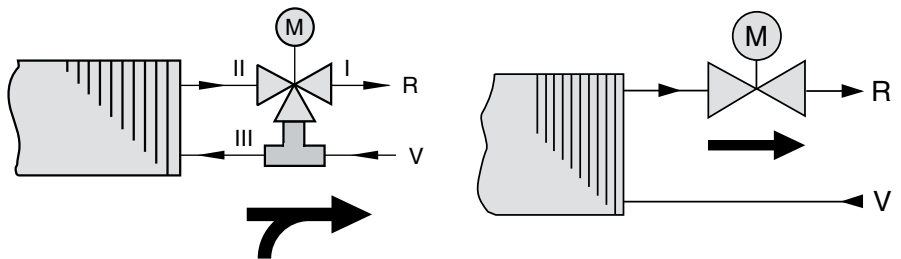

## Factory-installed options

### Electric heater

The electric heater is made of a sealed bar heater inserted into an aluminum louvered radiator to deliver an optimum homogeneous temperature. Each heater is equipped with an automatic reset cut-out thermostat directly fixed on the electric heater element. In addition there is a manual reset cut-out thermostat with a temperature setting of 80°C.

All units with electric heater have a galvanized painted drain pan to avoid damage to the unit in case of partial or complete loss of airflow before the thermostat tripping is completed.

### Condensate pump

The reciprocating condensate pump can be factory-mounted. It is very quiet and does not affect the unit's sound performance. The water drainage performance depends upon elevation and pipe horizontal length. A drain pan is delivered with the factory-mounted condensate pump.

Elevation (m)	Water flow function of horizontal length and vertical elevation	
	5 m	10 m
1	6.80	6.30
2	5.50	5.00
3	4.20	3.80
4	3.00	2.60

### Factory-mounted controls

Three types of controls are available:

1. Standalone applications where one thermostat interface is used for each individual unit. The unit is equipped with a terminal strip in the control box to which the remote wall mounted thermostat need to be connected. There is the possibility to connect another unit using the relay card for the fan speed control: model REL03 for thermostat models N, P, T and REL02 for thermostat model U for the AC fan motor unit type. For the EC fan motor unit type, the T-EC thermostat can control up to 16 units each equipped with the REL04 accessory card.
2. Group control where one user interface is used for several units installed and connected together through a serial link RS485 using a ModBus communication protocol. Up to 20 units can be connected to each other. Please refer to the installation manual for this. The ambient air temperature can be controlled via the indoor sensor installed on the T-MB wall mount thermostat interface or through the return air sensor of each individual unit. There is also the possibility to install an infrared receiver with a handset transmitter field installed. The ambient temperature is then controlled via the return air sensor of each individual unit.
3. Building Management System for office building where all equipment shall be supervised by a main control system. The air ambient temperature can be controlled via communicating wall mounted thermostat, or equipment return air sensor.

The Tracer™ ZN 523 and 525 BMS is factory-configured for the customer's requirements and uses ZSM10 and ZSM11 wall thermostats. Contact your Trane controls sales engineer for more information.

## Standalone controls

---

### Thermostat N - AC fan motor

(Accessory 35169830-001)

CONTROL WITH ELECTROMECHANIC  
THERMOSTAT

Figure 1 - Thermostat N



Main characteristics:

- On/off switch.
- Manual speed switch.
- Manual Summer/Winter switch.
- Temperature setting

Operation:

- 1-step heating
- 1-step cooling
- Controls one water valve ON-OFF for cooling
- Controls one electric heater or one water valve ON-OFF for heating
- Fan runs continuously regardless of water valve operation when the thermostat is turned ON.

## Standalone controls

---

### Thermostat P - AC fan motor

ELECTROMECHANIC THERMOSTAT

AUTO CHANGEOVER + ELECTRIC  
HEATER

(Accessory 35169831-001)

Figure 2 - Thermostat P



Main characteristics:

- On/off switch.
- Manual speed switch.
- Automatic Summer/Winter change-over.
- Temperature setting

Operation:

- 2-step heating
- 1-step cooling
- Controls one water valve ON-OFF for cooling
- Controls one water valve ON-OFF for heating
- Controls one electric heater as second step heating
- Fan runs continuously regardless of water valve operation when the thermostat is turned ON.

## Standalone controls

---

### Thermostat T - AC fan motor

#### CONTROL WITH ELECTRONIC THERMOSTAT

(Accessory 35169834-001)

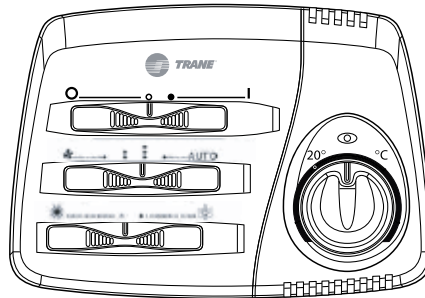

#### Main characteristics:

Same characteristics as the R control, adding:

- Manual or automatic speed switch.
- Electronic thermostat for fan control (on/off).
- Electronic thermostat for valve(s) control (on/off).
- Simultaneous thermostatic control on the valves and fan (on/off).
- It allows installation of the Summer/Winter switch centralized and remote, or to control it with an automatic change-over fitted on the water pipe (for 2 pipe installations only). The last case needs the adjustment of the jumper on the control board (see the instruction leaflet supplied with the control).



## Standalone controls

### Thermostat T-EC - EC fan motor

Thermostat accessory 35169884-001

Relay card REL04 accessory 35169885-001

Thermostat T-EC + relay card REL04 accessory 35169886-001

The thermostat is connected to a unit controller REL04 with 2 wires. One thermostat can be used for up to 16 units equipped with the REL04 control card creating a Master/Slave configuration with interconnection between all REL04 control cards.

#### Main characteristics

- On/Off button
- Manual 3 speed switch or automatic continuous speed control
- Manual winter / summer switch
- Temperature setting button
- Control up to 16 units in Master / Slave configuration



#### Operation

- 1 step cooling for water valve control On/Off
- 1 step heating for water valve or electric heater control On/Off
- Simultaneous control of the water valves / electric heater and fan operation based on the difference of the room temperature and set point
- It allows controlling the summer / winter cycle with a centralized and remote switch or with an automatic change over switch fitted on the water pipe
- With 4 pipe installation it can be configured as an automatic change over winter / summer with a neutral dead band of 2°C around set point
- Fan runs continuously and for auto fan mode the speed varies based on the difference of the room temperature and set point



## Standalone controls

---

### Thermostat U - AC fan motor

#### CONTROL WITH ELECTRONIC THERMOSTAT

(Accessory 35169835-001)



#### Main characteristics:

- Manual or automatic speed switch.
- Manual or automatic Summer/Winter switch.
- Electronic thermostat for fan control (on/off).
- Electronic thermostat for valve(s) control (on/off).
- It allows to control the minimum water temperature sensor (MWT).
- It allows to control the chilled water valve (on/off) and the electric resistance in the CWS-E version.
- It allows to control the fan and the heating electric resistance.
- It allows to control up to 10 units with the REL02 relay board.

**Note:** with 4 pipe installations and continuous chilled and hot water supply, it allows the automatic summer/winter change-over in accordance to the room temperature (-1,6°C = Winter, +1,6°C = Summer, Dead Zone 3,2°C).



## Group controls

---

### Group control via ModBus communication protocol through RS485 serial link

The MB controller is suitable for AC and EC fan motor technology. It can be connected to one T-MB thermostat or RT03 infrared remote controller field installed. One device can control up to 20 units in a Master/Slave configuration with ambient temperature controlled based on thermostat or on return air temperature sensor. When connected to the centralized time of day scheduler TODS controller, up to 60 units can operate together on the same agenda for 7 days each operating on individual set points and fan control. For rooms where set points and fan operation is left to occupants the MB controller can be connected to one T-MB thermostat or RT03 infrared remote control. In this case the latest command from any of the connected devices thermostat T-MB / RT03 or TODS is executed by the MB controller. If more than 60 units have to be installed in the building operating under the same TODS agenda, some terminal units serving the same zone in an open space shall be installed without control. It will be connected to a unit with MB controller using a relay card RELO3 for units with AC fan motor or in a wired daisy chain arrangement for EC fan motor but with a limitation to 5 units in this case. The same strategy shall be used for zones where several units shall be installed so only one user interface T-MB or RT03 is required per zone for several units.

### System configuration

More over, the TODS centralized controller is capable to pilot up to 8 external devices like a chiller or an air handler using the external control card ECC. Each external device can provide the state of operation to the TODS controller to provide a diagnosis about the installation. Such the MB control using ModBus communication protocol is a powerful device than can operate a small building in a system configuration.

### Configuration and commissioning

The MB controllers are factory configured for the application. The terminal address and operating parameters are configured on the controller using dip switches which make the commissioning accessible to anyone reading simple instructions in the installation manual.

# Group controls

## T-MB thermostat

(Accessory 35169876-001)

The T-MB thermostat and the Modbus controller suit all types of system applications.

- 2 or 4 pipe
- 2-pipe with auto changeover
- 2-step heating with electric heater
- Fan operation with continuous or alternate with destratification.

It is connected to the factory-mounted unit controller MB and configured for the customer's requirements. The MB controller can be connected in a Master/Slave configuration with up to 20 units.

External devices: window contact, cold air draft protection with T3 sensor.

The T-MB wall-mounted thermostat is used with the Modbus controller fitted on the cassette. The Modbus controller is factory-configured for the customer's application. The T-MB thermostat is configured by default to control air ambient temperature based on the temperature sensor of the thermostat. In the case that return air temperature is used, it can be configured using the dipswitch 2 in position ON during installation.

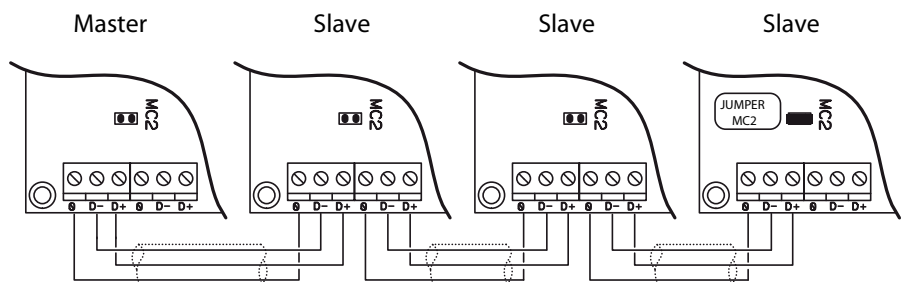
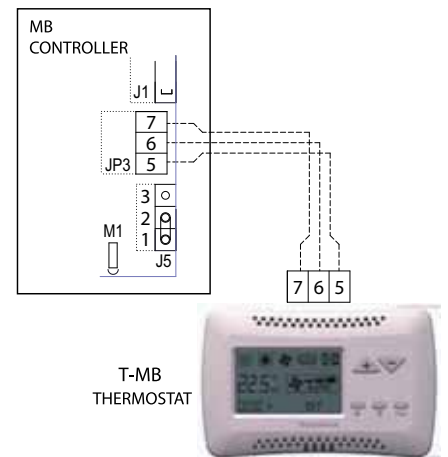

TYPE BELDEN 9841, RS-485, 1x2x24 AWG SFTP, 120 Ohm



# Group controls

## RT03 remote control (accessory 35169889-001)

The RT03 is a remote controller handset that can be fitted with the MB electronic board as an accessory. There is a remote sensor to install on site and some configuration dipswitches to turn on. It is possible to connect up to 20 units with a serial link RS485 for a master/slave configuration. It is recommended to install the infra-red receiver on the master unit.

Figure 3 - Infra-red remote control/field-installed receiver/installation in a ceiling tile

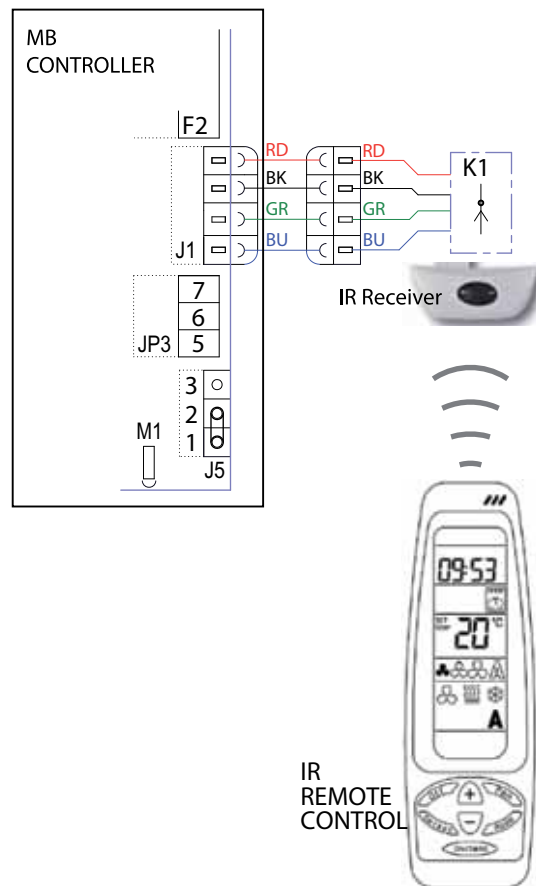

## Note

For more details, please refer to the infra-red remote control manual.

### Control operations

- Temperature set.
- Fan speed switch with possible automatic speed selection.
- 24 hours on/off program.
- on/off cooling valve control.
- on/off heating valve control.
- Control of the valves only or of the valves and the fan together.
- Valve control of 2 or 4 pipe systems with winter/summer switch on the infra-red control.
- Valve control of 4 pipe systems with automatic heating/cooling mode selection with 2°C dead zone.
- Activating the COE sensor connected to the T2 contact of the board (non active in the standard configuration), it works like a minimum water temperature sensor: fitted between the coil fins it stops the fan when the water temperature is lower than 38°C and it starts the fan when the water temperature reaches 42°C

## Group controls

### Main functions of the remote control

Figure 4 - Remote control display

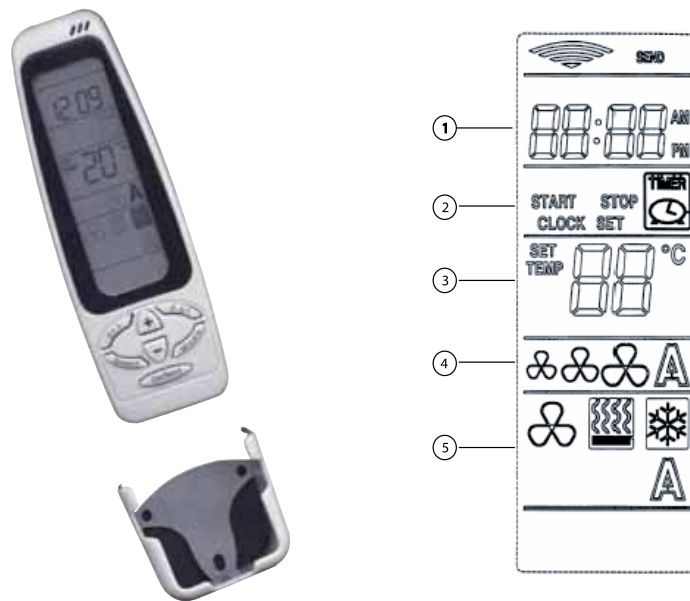

1. Clock : 24 hours
2. Timer : the program switches the device on and off
3. Displays the temperature setpoint
4. Fan speed setting: 3 speed plus automatic selection
5. Operating mode: heat, cool, fan only plus and automatic mode selection.

#### Timer function:

Used to start or stop the unit over a 12 hour period.

#### Set display:

Used to display the temperature set point.

#### Fan speed setting:

Used to select the 3 operating speeds of the fan, or alternatively select automatic control. In the latter case, the fan speed will change automatically based on the ambient temperature reading and the set point. The temperature difference to switch from one speed to the next is 0.7 °K.

#### Operating mode:

Used to select the desired operating mode, that is, fan only, cooling, heating or automatic mode selection.

Automatic selection allows, in 4 pipe systems, the unit to switch automatically from heating to cooling and vice-versa based on the ambient temperature reading and the set point, with a dead zone of 2°K inside which the unit remains in fan only mode.

# Building Management Controls

## Intelligent LonTalk® ZN523 control for AC fan motor

The Tracer® ZN unit controller is a micro-processor based direct digital controller that is dedicated to the control and the optimization of the units. It is designed to provide improved comfort with minimum energy consumption through the use of custom proportional integral derivative (PID) control algorithms as well as intelligent fan speed and set point control strategies. It is factory installed, pre-commissioned and tested, resulting in a highly integrated product, reduced installation and commissioning time.

The following configurations are supported by the controller:

- 2-pipe cooling;
- 2-pipe cooling + electric heater;
- 2-pipe changeover (manual or automatic);
- 2-pipe changeover + electric heater;
- 4-pipe.

Figure 5 - LonTalk® ZN523 control



The intelligent control offers the following benefits:

- Intelligent management of valve position and fan speeds. Valve is fully open before changing the fan speed (acoustic comfort optimization).
- Control algorithms based on ambient and discharge air temperatures.
- Discharge air temperature (low and high limit control).
- Automatic intelligent changeover based on ambient air - entering water temperatures differential (+/-%2.5K).
- Automatic intelligent changeover with sampling function for 2-way valves use.
- Filter timer for preventive maintenance
- Adjustable local set point max - min limits.
- Built-in electrical protection.
- 2 operating modes in stand-alone application: comfort and reduce.
- After a power up in the building, units automatically staggered from 5 to 32 seconds.
- Built-in adjustable timed override function.
- Built-in condensate overflow protection.
- Built-in output test capability.
- Built-in diagnostic indicator.

Figure 6 - Normal operating mode

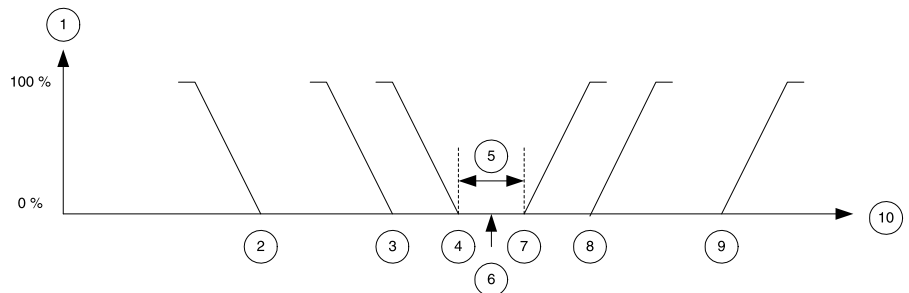

1. Control output
2. Unoccupied heating setpoint
3. Occupied standby heating setpoint
4. Occupied heating setpoint
5. Dead band
6. Local setpoint
7. Occupied cooling setpoint
8. Occupied standby cooling setpoint
9. Unoccupied cooling setpoint
10. Temperature

For more details about the LonTalk® ZN control, please refer to the controller's manual.

## Accessories (Field installed)

### Fresh air spigot (FKAS-FKAE unit only)

2 fresh air spigots with diameter 99 mm (45 m<sup>3</sup>/h) and 124 (180 m<sup>3</sup>/h) mm can be field installed on the opposite side of the control box on the return air side of the unit between the filter and the fan assembly. They are suitable for use with constant volume damper that can be fitted directly inside the spigot. It is necessary to remove the precut circular sheet metal on site and the spigot can be directly screwed to the unit using the free holes for this. The sheet metal screw size 4 mm shall be used.

### Constant volume fresh air damper (FKAS-FKAE unit only)

The damper is available on 99 mm or 124 mm fresh air spigot. It allows fresh air introduction on return air side of the unit.

- 99 mm handles up to 45 m<sup>3</sup>/h
- 124 mm handles up to 180 m<sup>3</sup>/h

### Auxiliary drain pan

On horizontal installations, there is one model for left hand configurations and one model for right hand unit configurations. On vertical installations, the same model is used for both left and right hand configurations. The auxiliary drain pan shall be installed below the water valve package on the opposite side of the control box. It is made of plastic material ABS UL 94-HB.

### Condensate pump

A condensate pump kit is available for field installations. It has the same performance results as the factory-mounted version, see page 40.

### Water valve kits

Several water valves kits are available for field installation. They are the same as the factory-mounted ones. The kit includes the valve, the actuator and the copper piping for connection to valve body. Leak tightness is ensured with synthetic flat joints delivered with the kit.

They are available in 2 and 3-way models and for thermal hot wax actuator only.

### Copper connection

This kit is used for field-installed water valves in order to have the inlet and outlet connections distant from 40 mm suitable for any water valve type. It is delivered with synthetic flat joints.

### Filter

EU3 spare filters are available for field installation, made of 8 mm synthetic thick material class M1.

### Feet & return air Grille (FVAS-FVAE only)

The feet are available as accessory. It is made in the same plastic color and material as cabinet plastic parts.

Feet raise the height of the unit by 100 mm.

Return air grille is also available as spare accessory. It is a white grey anodized aluminum louvered grille.



### Rear closing panel (FVAS-FVAE – FCAS-FCAE only)

The rear closing panel is fixed with 4 screws to the unit. It is useful to hide back side of unit on vertical installation.

### Bottom closing panel (FCAS-FCAE only)

Installed in horizontal position.

This accessory is not compatible with electric heater option.

### Front intake panel (FKAS-FKAE only)

It is used to have filter support on front return configuration concealed version. The kit includes filter rail and panel fitting.

## Accessories (Field installed)

---

### **Supply and return flanges, grille and Filter (FKAS-FKAE unit only)**

The flanges are used to connect ductwork on return and supply side. It exists in straight and with a 90° conversion version.

The grille accessory is used as diffuser for inlet and outlet on wall or ceiling opening.

A version of inlet grille is available with filter for easy filter access.

## Accessories (Field installed)

### Control accessories

#### T3 MWT Minimum Water temperature sensor (accessory 35169838-001)

Suitable for wall thermostats R, T, and U only (not for infra-red remote control). To be fitted between the coil fins, it is measuring the water temperature in the coil.

In heating mode, it stops the fan when the water temperature is lower than 38°C and it starts the fan when it is higher than 42°C.

It is a standard feature on unit equipped with the group control.

#### T2 Automatic change over pipe thermostat (accessory 35169820-001)

Suitable for wall thermostats N, P, R, T and U only (not for infra-red remote control). Automatic summer/winter switch to be installed in contact with the entering water circuit and before the control valve (for 2-pipe installations only). The cooling mode is allowed if the water temperature is below 15°C and the heating mode is allowed if the water temperature is above 25°C.

#### T2 Automatic change over pipe thermostat (accessory 35169839-001)

Suitable for MB controller with T-MB thermostat or RT03 remote control.



Thermostat T-EC

#### T-MB control (wall-mounted control) (accessory 35169876-001)



The T-MB is a wall-mounted control that can be connected to cassettes fitted with the IR electronic board. The T-MB control features the following functions:

- Switch the unit on and off.
- Temperature set.
- Fan speed switch with possible automatic speed selection.
- Setting the operating mode.
- 7-day time scheduler.

It can be installed one control per cassette, or one control for up to 20 cassettes (master/slave configuration) through RS485 serial link.

It is recommended to install the wall-mounted control on the master unit.

See Installation-Operation-Maintenance manual for wiring information.

#### Thermostat T-EC (accessory 35169884-001)

Thermostat for CFAE for installation on the job site. It can control up to 16 units.

#### Electronic control card (accessory 35169885-001)

For installation on the job site. One card per unit is required. To be used with thermostat T-EC.

#### Kit: Thermostat T-EC + electronic card (accessory 35169886-001)

For standalone installations.



# Accessories (Field installed)

## REL03 Relay card for master/slave configuration - AC fan motor (accessory 35169875-001)

Fitted in the control panel of the master and slave cassettes, this enables up to eight units to be controlled by the signal from a single remote control unit.

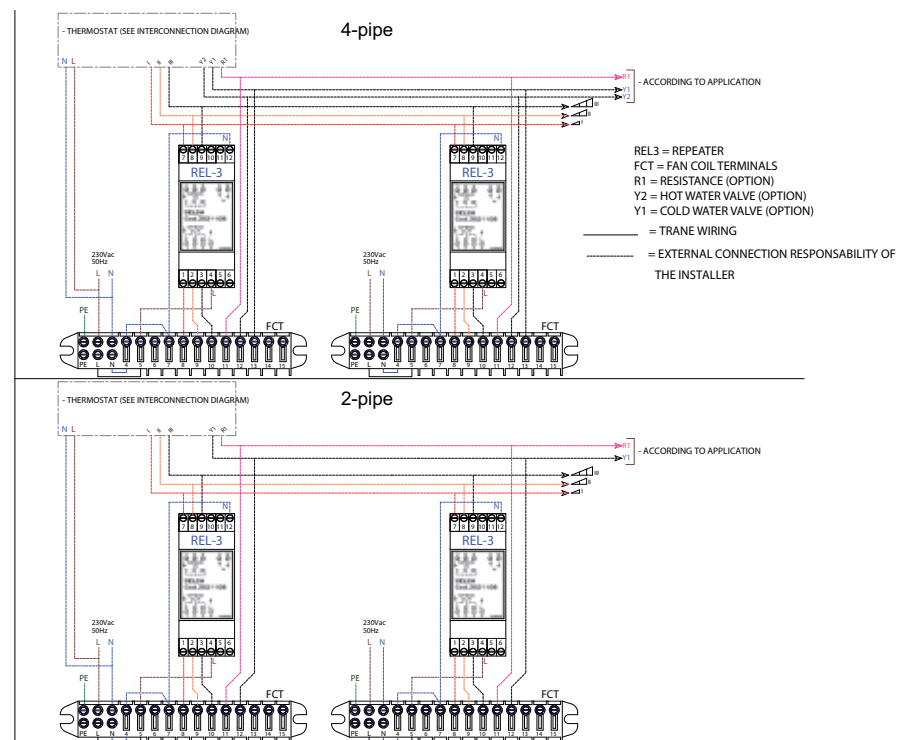

## Accessories (Field installed)

### REL02 for U-type thermostat -

#### AC fan motor (accessory 35169836-001)

It allows to control up to 10 units with RS485 serial link.

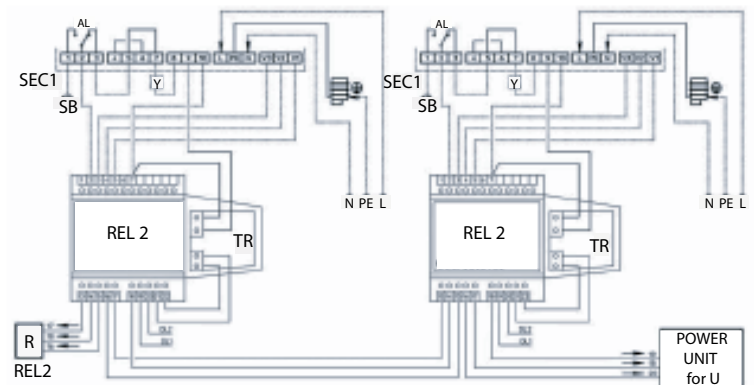

Figure 8 - REL02 connection with 1 valve

### REL04 for T-EC thermostat -

#### EC fan motor Accessory 35169885-001

It allows control of up to 16 units with RS485 serial link.



## Accessories (Field installed)



### TODS (Time Of Day Scheduler) Accessory 35169878-001

Designed to control up to 60 units in 2 zones within 7 days of operation plus with the external control board it can start and stop 8 other equipment's as:

- Chiller for cooling and heating water supply
- Boiler for hot water supply
- Air handler unit for fresh air supply
- Lamps
- Other devices

Each unit connected to the TODS will need to be identified with an alias number from 1 to 60 configured by dip switch on the MB unit control board. Each unit will dialogue with the TODS through the RS485 serial link using ModBus communication protocol. Each unit is controlled individually or all at a time per zone and from the TODS the following actions can be taken:

- View the unit operation mode as heating or cooling, fan operation, the ambient temperature
- Run the air-conditioning in comfort or economy mode or winter freeze control when off
- Turn On/Off each unit individually or all together
- Modify the operation parameters and temperature control of each individual unit or all units together
- Operate the Air-conditioning installation within 4 schedule range per day each with its own temperature setting over 2 zones maximum
- Run the system in Economy or Off mode during holidays. The number of days off needs to be entered the day before the start of the holiday period using the "Menu" button.

Note: the length of the RS485 cable cannot exceed 700 to 800 meters depending upon the cable quality and electromagnetic environment



### ECC System control board Accessory 35169887-001

The ECC control board is designed to control up to 8 external equipment within the association of the weekly scheduler TODS such as:

- Chillers
- Cooling and heating mode for the chillers
- Air handlers
- Dampers
- Lamps
- Extractor fans

It has 8 digital inputs that can be associated with any of the other 8 outputs.

The utilization of the TODS with the external control board ECC can really run efficiently the air-conditioning of any building configuration to reduce the cost of ownership.



Trane optimizes the performance of homes and buildings around the world. A business of Ingersoll Rand, the leader in creating and sustaining safe, comfortable and energy efficient environments, Trane offers a broad portfolio of advanced controls and HVAC systems, comprehensive building services, and parts. For more information, visit [www.Trane.com](http://www.Trane.com).

Trane has a policy of continuous product and product data improvement and reserves the right to change design and specifications without notice.